

Dear Reader ...

We would like to congratulate you on the purchase of your new motorhome. You have selected a top-quality vehicle which will afford you many years of enjoyment.

To enable you to always use and operate your motorhome properly and easily, your Bürstner dealer will first provide you detailed instructions for all important functions when you take delivery.

This manual, the instruction manuals from the base vehicle manufacturer as well as the instruction manuals from the appliance manufacturer will always be at hand to answer any questions you may have regarding your motorhome.

Before your first journey

Please familiarise yourself with this manual rather than relying on it strictly for reference.

Fill in the warranty cards for the appliances and special equipment in the individual instructions and send these cards to the respective manufacturers. This ensures your warranty claim for each appliance.

1	Introduction	7	4.5.3	Front and rear axle pneumatic spring	44
1.1	General	7	4.6	Seat belts	47
1.2	Environmental tips	8	4.6.1	General	47
2	Safety	9	4.6.2	Fastening the seat belt correctly	47
2.1	Fire prevention	9	4.7	Child restraint systems	47
2.1.1	Avoidance of fire risks	9	4.8	Pilot seats for the driver's and front passenger's seats	48
2.1.2	Fire-fighting	9	4.9	Seat heater (special equipment)	49
2.1.3	In case of fire	9	4.10	Headrests	49
2.2	General	10	4.11	Seating arrangement	50
2.3	Road safety	11	4.12	Roman shade in the driver's cabin	51
2.4	Towing	12	4.12.1	Pleated Roman shades	51
2.5	Gas system	12	4.12.2	Roman shades, Remis (special equipment)	51
2.5.1	General instructions	12	4.13	Refuelling	52
2.5.2	Gas bottles	14	5	Pitching the motorhome	53
2.6	Electrical system	14	5.1	Handbrake	53
2.7	Water system	14	5.2	Entrance step	53
3	Before the journey	17	5.3	Ramps	53
3.1	Keys	17	5.4	Wheel chocks	53
3.2	Registration	17	5.5	Supports	54
3.3	Payload	18	5.5.1	General instructions	54
3.3.1	Terms	18	5.5.2	Steady legs (SAWIKO) (partially special equipment)	54
3.3.2	Calculating the payload	20	5.5.3	Steady legs (AL-KO) (partially special equipment)	55
3.3.3	Loading the vehicle correctly	22	5.6	Electrical steady legs (AL-KO) (special equipment)	56
3.3.4	Roof rail and ladder (special equipment)	23	5.7	230 V connection	58
3.3.5	Rear garage/rear storage space	24	5.8	Refrigerator	58
3.3.6	Double floor (Argos 747-2)	25	5.9	Satellite unit (special equipment)	58
3.3.7	Bike rack (special equipment)	25	5.9.1	Equipment with automatic antenna alignment (Alden)	58
3.3.8	Bike/e-bike bike rack (special equipment)	27	5.9.2	Equipment with automatic antenna alignment (Oyster)	59
3.3.9	Removable load rack AL-KO (special equipment)	29	5.10	Awning (special equipment)	60
3.3.10	Load rack SAWIKO (special equipment)	30	6	Living	61
3.4	Towing	31	6.1	Central locking system (special equipment)	61
3.5	Caravan coupling (special equipment)	31	6.2	Conversion door	61
3.6	Electrically operated entrance step	32	6.2.1	Conversion door, outside (Hartal M1)	62
3.7	TV unit (special equipment)	33	6.2.2	Conversion door, inside (Hartal M1)	62
3.8	Sink and drain basin covers	34	6.2.3	Conversion door, outside (Hartal Premium) (partially special equipment)	63
3.9	Securing add-on parts	34	6.2.4	Conversion door, inside (Hartal Premium) (partially special equipment)	63
3.10	Snow chains (special equipment)	35	6.2.5	Window of conversion door (Hartal Premium) (partially special equipment)	64
3.11	Road safety	35			
4	During the journey	39			
4.1	Driving the motorhome	39			
4.2	Reversing camera (partially special equipment)	40			
4.3	Driving speed	40			
4.4	Brakes	41			
4.5	Pneumatic spring (special equipment)	41			
4.5.1	General instructions	41			
4.5.2	Rear axle pneumatic spring	42			

Contents

6.2.6	Folding insect screen on the conversion door (partially special equipment)	64	6.16	Converting seating groups for sleeping	96
6.3	External flaps	65	6.16.1	Central seating group (Argos 747-2)	96
6.3.1	Flap lock with recessed handle	65	6.16.2	Central seating group with additional cushion (Argos time 650 and 660)	97
6.3.2	Flap lock, square	66	6.16.3	Bench with divan (Argos time 670)	97
6.3.3	Flap lock with push button	66	6.17	Shower connection point for external shower (special equipment)	98
6.3.4	Flap for the 230 V connection, square	67	7	Gas system	99
6.3.5	Cap for the drinking water filler neck	67	7.1	General	99
6.4	Furniture flaps and inner doors	68	7.2	Gas bottles	100
6.4.1	Furniture flaps with push button	68	7.3	Changing gas bottles	101
6.4.2	Furniture flaps with release handle	68	7.4	Gas isolator taps	102
6.4.3	Floor compartment cover	69	7.5	External gas connection (special equipment)	102
6.4.4	Driver's cabin partition (only Argos 747-2)	69	7.6	Crash protection unit switching facility (special equipment)	103
6.5	Light switch	70	8	Electrical system	107
6.5.1	Entrance area	70	8.1	General safety instructions	107
6.5.2	Interior	70	8.2	Terms	108
6.5.3	Wardrobe light (partially special equipment)	71	8.3	USB socket	109
6.6	Spotlight	72	8.4	12 V power supply	109
6.7	Light control (only Argos 747-2)	72	8.4.1	Selector switch for radio (special equipment)	110
6.8	Holder for flat screen	74	8.4.2	Starter battery	110
6.8.1	Holder on the column	74	8.4.3	Living area battery	112
6.8.2	Holder with jointed arm	75	8.5	Transformer/rectifier	113
6.8.3	Holder in the TV cabinet	75	8.5.1	Transformer/rectifier (EBL 99)	113
6.9	Ventilation	76	8.5.2	Transformer/rectifier (EBL 220)	116
6.10	Windows	76	8.6	Panel IT 96-2 (Argos Time)	118
6.10.1	Hinged window with rotary hinges	77	8.6.1	12 V main switch	118
6.10.2	Hinged window with automatic hinges	79	8.6.2	V/tank gauge for battery voltage and water or waste water levels	119
6.10.3	Blind and insect screen	81	8.6.3	Switch for water pump	121
6.10.4	Roman shade and insect screen	82	8.6.4	Battery alarm for the living area battery	121
6.10.5	Roman shades for windscreen, driver's window and front passenger's window	83	8.6.5	12 V indicator lamp	121
6.11	Skylights	84	8.6.6	230 V indicator lamp	121
6.11.1	Heki skylight (mini and midi) (partially special equipment)	85	8.7	Panel LT 510 (Argos 747-2)	121
6.11.2	Wind-up skylight (partially special equipment)	86	8.7.1	230 V indicator lamp	122
6.11.3	Omni-Vent skylight with fan (special equipment)	87	8.7.2	12 V main switch	122
6.11.4	Skyroof skylight	88	8.7.3	Batteries gauge	123
6.12	Suspension table	90	8.7.4	Tank gauge	125
6.13	Divan adjustment mechanism (only Argos 747-2)	92	8.7.5	Alarms	125
6.14	Additional seat (only Argos 747-2)	93	8.7.6	Temperature display	126
6.15	Beds	93	8.7.7	Switch for tank heater	126
6.15.1	Overcab bed	93	8.7.8	Switch for water pump	127
6.15.2	Fixed bed (gas-pressure springs)	95	8.8	Fuel cell (EFOY) (special equipment)	127
6.15.3	Fixed bed (adjustable head section)	95	8.9	Solar installation (special equipment)	130
6.15.4	Bunk bed	96	8.10	230 V power supply	131
			8.10.1	230 V connection	132

8.10.2	Connecting 230 V power supply	132	9.6.3	Operation (Dometic RMD 8 series with automatic power selection and frame heater)	181
8.11	Fuses	133	9.6.4	Refrigerator door locking mechanism	184
8.11.1	12 V fuses	133	10	Sanitary fittings	187
8.11.2	230 V fuse	138	10.1	Water supply, general	187
8.12	External socket (special equipment)	139	10.2	Water system	188
8.13	Circuit diagrams	140	10.2.1	Water tank	188
8.13.1	Circuit diagrams, interior	140	10.2.2	Auxiliary water tank (special equipment) (only Argos 747-2)	188
8.13.2	Circuit diagram, exterior	145	10.2.3	Drinking water filler neck with cap	189
9	Appliances	147	10.2.4	Filling the water system	189
9.1	General	147	10.2.5	Topping up the water	191
9.2	Heater	148	10.2.6	Closing/opening the overflow	191
9.2.1	Models with waste gas vent on the right-hand side of the vehicle	148	10.2.7	Draining water (handle with overflow)	191
9.2.2	To heat properly	148	10.2.8	Emptying the water system	192
9.2.3	Truma Combi hot-air heater	149	10.3	Waste water installation	193
9.2.4	Hot-air heater with CP plus digital operating unit	151	10.3.1	Draining waste water	193
9.2.5	Alde hot-water heater (only Argos 747-2)	154	10.3.2	Heater for waste water tank and waste water pipes (special equipment)	195
9.2.6	Auxiliary heat exchanger (special equipment)	160	10.3.3	Warming unit for waste water pipes (special equipment)	195
9.2.7	Electrical floor warming unit (special equipment)	161	10.4	Toilet compartment	196
9.2.8	Independent vehicle heater (special equipment)	161	10.5	Toilet	197
9.3	Air conditioning unit (special equipment)	163	10.5.1	Preparing toilet	197
9.3.1	Dometic	163	10.5.2	Swivel toilet	198
9.3.2	Telair	164	10.5.3	Toilet with fixed seat	199
9.4	Boiler	165	10.5.4	Emptying the sewage tank	200
9.4.1	Models with waste gas vent on the right-hand side of the vehicle	166	11	Care	201
9.4.2	Truma Combi boiler	166	11.1	External care	201
9.4.3	Truma boiler with operating unit CP plus	169	11.1.1	General	201
9.4.4	Alde boiler	171	11.1.2	Washing with a high-pressure cleaner	201
9.5	Cooker	172	11.1.3	Washing the vehicle	202
9.5.1	Gas cooker	172	11.1.4	Windows of acrylic glass	202
9.5.2	Gas cooker with gas oven and gas grill (only Argos 747-2)	173	11.1.5	Underbody	202
9.5.3	Gas oven (Dometic) (special equipment)	175	11.1.6	Entrance step	203
9.5.4	Microwave oven (special equipment)	177	11.1.7	Pneumatic spring	203
9.5.5	Extractor hood (partially special equipment)	178	11.2	Interior care	203
9.6	Refrigerator	178	11.3	Water system	204
9.6.1	Refrigerator ventilation grill	179	11.3.1	Cleaning the waste water tank	204
9.6.2	Operation (Dometic 8 series with manual power selection MES)	179	11.3.2	Cleaning the water tank	205
			11.3.3	Cleaning the water pipes	205
			11.3.4	Disinfecting the water system	206
			11.4	Extractor hood	206
			11.5	Air conditioning unit	206
			11.5.1	Dometic	206
			11.5.2	Telair	207
			11.6	Winter care	207
			11.6.1	Preparations	207

Contents

11.6.2	Winter operation	208	13.6.1	Spare wheel support under the vehicle (basket)	233
11.6.3	At the end of the winter season	208	13.6.2	Spare wheel support in the rear garage	233
11.7	Lay-up	208	13.7	Tyre pressure	234
11.7.1	Temporary lay-up	208	14	Troubleshooting	237
11.7.2	Winter lay-up	210	14.1	Braking system	237
11.7.3	Starting up the vehicle after a temporary lay-up or after lay-up over winter	211	14.2	Pneumatic spring	237
12	Maintenance	213	14.3	Electrical system	238
12.1	Inspection work	213	14.4	Fuel cell	241
12.2	Maintenance work	213	14.5	Gas system	241
12.3	Doors	214	14.6	Heater/boiler	242
12.4	Living area battery	214	14.6.1	Truma heater/boiler with analogue operating unit	242
12.5	Fuel cell	214	14.6.2	Truma heater/boiler with CP plus digital operating unit	243
12.5.1	Replacing the tank cartridge	214	14.6.3	Alde heater/boiler	245
12.5.2	Refilling service fluid	215	14.7	Air conditioning unit	246
12.6	Alde hot-water heater	215	14.7.1	Dometic	246
12.6.1	Checking the fluid level	216	14.7.2	Telair	246
12.6.2	Topping up heating fluid	216	14.8	Cooker	247
12.6.3	Bleeding the heating system	216	14.8.1	Gas cooker/gas oven	247
12.6.4	Position of the bleeding valves	217	14.8.2	Microwave oven	247
12.7	Independent vehicle heater	217	14.9	Refrigerator	247
12.8	Replacing bulbs, external	217	14.10	Water supply	249
12.8.1	Front lights	218	14.11	Body	250
12.8.2	Rear lights	218	15	Special equipment	251
12.8.3	Side lights	219	15.1	Weight details for special equipment	251
12.8.4	Types of bulbs for exterior lighting	219	16	Technical data	255
12.9	Replacing bulbs, internal	220	16.1	View of ground plans	255
12.9.1	Halogen ceiling lamp	220	16.2	Table of linear measures	256
12.9.2	Surface-mounted LED light	221	16.3	Power supply	257
12.9.3	Recessed lights with LED	221	17	Helpful notes	259
12.9.4	Recessed halogen light (flat)	222	17.1	Traffic rules in foreign countries	259
12.9.5	Halogen spotlight (movable)	222	17.2	Help on Europe's roads	259
12.9.6	Wardrobe light	223	17.3	Traffic rules for motorhomes	262
12.9.7	Surface mounted light	223	17.4	Sleeping in the vehicle away from camping areas	264
12.9.8	AL-KO rear axle	224	17.5	Gas supply in European countries	266
12.9.9	Spare parts	224	17.6	Toll regulations in European countries	267
12.10	Vehicle identification plate	225	17.7	Tips on staying overnight safely during travel	267
12.11	Warning and information stickers	225	17.8	Tips for winter campers	268
13	Wheels and tyres	227	17.9	Travel checklists	268
13.1	General	227	18	Inspection plan	271
13.2	Tyre selection	228			
13.3	Tyre specifications	229			
13.4	Handling of tyres	229			
13.5	Changing wheels	229			
13.5.1	General instructions	229			
13.5.2	Tightening torque	230			
13.5.3	Changing a wheel	232			
13.6	Spare wheel support under the vehicle (special equipment)	233			

Please read this instruction manual completely before using the vehicle for the first time!

Always keep this instruction manual in the vehicle. Also inform all other users of the safety regulations.



- ▶ The non-observance of this symbol can lead to personal injury.



- ▷ The non-observance of this symbol can lead to damage being caused to, or inside the vehicle.



- ▷ This symbol indicates recommendations or special aspects.



- ▷ This symbol indicates actions which lead to environmental awareness.

This instruction manual contains sections which describe model-specific equipment or special equipment. These sections are specially marked. It may be that your vehicle has not been fitted with this special equipment. In some cases, the actual equipment of your vehicle may therefore be different from that shown in some illustrations and descriptions.

However, your vehicle may be fitted with other special equipment not described in this instruction manual.

Special equipment is described when an explanation is required.

Adhere to the instruction manuals which are separately enclosed.



- ▷ The details "right", "left", "front" and "rear" always refer to the vehicle in direction of travel.
- ▷ All dimensions and weight details are "approximate".

Should the vehicle be subjected to damage due to a failure to follow the instructions in this instruction manual, then the guarantee claim is deemed invalid.

Our vehicles are subjected to continuous development. Please understand that we reserve the right to alter the form, equipment and technology. Therefore, no claims can be made against the manufacturer as a result of the contents of this instruction manual. The equipment which was known and included at the time of going to press is described.

The reprinting, translation and copying, including extracts is not permitted without prior written authorisation from the manufacturer.

1.1 General

The vehicle is constructed in accordance with the latest technology and the recognised safety regulations. Nevertheless, personal injury may result and the vehicle may be damaged if the safety instructions in this instruction manual are not followed.

Only use the vehicle in a technically impeccable condition. Follow the instructions in the instruction manual.

Malfunctions which impair the safety of persons or the vehicle should be immediately remedied by qualified personnel. To avoid further damages, observe the duty to avert, minimize or mitigate loss for the user during faults.

Have the vehicle's braking and gas systems inspected and repaired by an authorised specialist workshop only.

Alterations to the body are only to be carried out with the authorisation of the manufacturer.

The vehicle is designed for the exclusive transport of persons. Luggage and accessories may only be transported up to the maximum permissible gross weight.

Observe the test and inspection periods stipulated by the manufacturer.

1.2 Environmental tips



- ▷ Be considerate of the environment.
- ▷ Remember that: All kinds of waste water and household waste are not to be disposed of in drains or in the open countryside.
- ▷ On board, collect waste water only in the waste water tank or – if necessary – in other containers designed for that purpose.
- ▷ Only empty the waste water tank and toilet cassette or sewage tank at disposal stations at the camping or caravan sites, which are especially provided for this purpose. When stopping in towns and communities, observe the instructions at caravan sites or ask where there are disposal stations.
- ▷ Empty waste water tank as often as possible, even when it is not completely full (hygiene).
If possible, flush out waste water tank and, if necessary, drainage pipe with fresh water every time it is emptied.
- ▷ Never allow the toilet cassette or sewage tank to become too full. Empty the toilet cassette or sewage tank frequently, at the latest as soon as the level indicator lights up.
- ▷ Separate household waste according to glass, tin cans, plastic and wet waste also when on a journey. Enquire at the town or community authority about disposal points. Household waste is not to be disposed of in waste paper baskets which are situated at car parks.
- ▷ Empty waste bins as often as possible into the containers provided for this purpose. This helps to avoid unpleasant smells and an accumulation of rubbish on board.
- ▷ When parked, do not allow the engine to run more than necessary. When running idle, a cold engine releases more contaminants than usual. The running temperature of the engine is achieved more quickly whilst the vehicle is in motion.
- ▷ Use an environmentally-friendly WC chemical agent for the WC which can also be biologically degraded and only use small doses.
- ▷ When staying in towns and communities for long periods, search for parking areas which are specially reserved for motorhomes. Enquire at the town or community authority about parking spaces.
- ▷ Always leave the parking places in a clean condition.

Chapter overview

This chapter contains important safety instructions. The safety instructions are for the protection of persons and property.

The instructions address the following topics:

- fire prevention and what to do in case of fire
- general care of the vehicle
- road safety of the vehicle
- towing
- gas system of the vehicle
- electrical system of the vehicle
- water system of the vehicle

2.1 Fire prevention

2.1.1 Avoidance of fire risks



- ▶ Never leave children in the vehicle unattended.
- ▶ Keep flammable materials clear of heating and cooking appliances.
- ▶ Halogen lamps can get very hot. When the light is switched on, there must always be a safety distance of 30 cm between light and flammable objects. Fire hazard!
- ▶ Never use portable heating or cooking appliances.
- ▶ Only authorised qualified personnel may make changes to the electrical system, gas system or appliances.

2.1.2 Fire-fighting



- ▶ Always carry a dry powder fire extinguisher in the vehicle. The fire extinguisher must be approved, tested and close at hand.
- ▶ Have the fire extinguisher tested at regular intervals by authorised qualified personnel. Observe the date of testing.
- ▶ Depending on the equipment, the fire extinguisher is included in the scope of delivery.
- ▶ Always keep a fire blanket near the cooker.

2.1.3 In case of fire



- ▶ Evacuate all passengers.
- ▶ Cut off the electrical power supply and disconnect from the mains.
- ▶ Close regulator tap on the gas bottle.
- ▶ Sound the alarm and call the fire brigade.
- ▶ Fight the fire if this is possible without risk.



- ▷ Acquaint yourself with the position and operation of the emergency exits.
- ▷ Keep escape routes clear.
- ▷ Observe the fire extinguisher instructions for use.

All windows and doors which meet the following requirements are considered as emergency exits:

- Open to the outside or can be shifted in horizontal direction
- Opening angle at least 70°
- Minimum diameter of clearance = 450 mm
- Maximum distance from the vehicle floor = 950 mm

2.2 General



- ▶ The oxygen in the vehicle interior is used up by breathing and the use of gas operated appliances. That is why the oxygen needs to be replaced on a constant basis. For this purpose, forced ventilation options (e.g. skylights with forced ventilation, mushroom-shaped vents or floor vents) are fitted to the vehicle. Never cover or block forced ventilations from the inside or outside with objects such as e.g. a winter mat. Keep forced ventilations clear of snow and leaves. There is a danger of suffocation due to increased CO₂ levels.
- ▶ Do not use storage compartments or rear garages as places for people or animals to stay or sleep in. These spaces are not forced-air ventilated. There is a danger of suffocation due to oxygen deprivation or exhaust from the heater.
- ▶ Observe the headroom of the doors.



- ▷ As far as the fitted appliances (heater, cooker, refrigerator, etc.) and the base vehicle (engine, brakes, etc.) are concerned, the instruction manuals are authoritative. It is imperative that they be observed.
- ▷ Fitting accessories or special equipment can alter the dimensions, weight and road behaviour of the vehicle. Some of the parts must be entered in the vehicle papers.
- ▷ Only use wheel rims and tyres which are approved for the vehicle. Information concerning the size of the approved wheel rims and tyres is included in the vehicle documents or can be obtained from authorised dealers and service centres.
- ▷ Firmly apply the handbrake when parking the vehicle.
- ▷ If the maximum permissible gross weight of the vehicle exceeds 4 tonnes, wheel chocks must be used when parking on gradients. The wheel chocks are provided as standard for vehicles with a maximum permissible gross weight exceeding 4 tonnes.



- ▷ When leaving the vehicle, it is imperative that all doors, external flaps and windows are closed.
- ▷ Carry a hazard warning triangle and a first-aid kit and/or flashing hazard warning light when this is required by law.
- ▷ The vehicle may only be driven by drivers who hold a driving licence which is valid for the respective vehicle class.
- ▷ When selling the vehicle, hand over all instruction manuals for the vehicle and the fitted appliances.

2.3 Road safety



- ▶ Before commencing the journey, carry out a functional check of indicating and lighting equipment, the steering and the brakes.
- ▶ If the vehicle has been stationary for a long period (approx. 10 months) have the braking and gas systems checked by an authorised specialist workshop.
- ▶ Before commencing the journey and after short interruptions of the journey, ensure that the entrance step is completely retracted.
- ▶ Before commencing the journey, open and secure the shades on the windscreen and on the driver's and front passenger's windows.
- ▶ Before commencing the journey, place and secure the flat screen and screen support in the initial position. If the screen holder is installed in a TV cabinet: Close TV cabinet.
- ▶ Before commencing the journey, take off the loose sink and drain basin covers and store them securely in the kitchen unit or the wardrobe.
- ▶ Carefully store all moving parts and all loose objects before starting your journey.
- ▶ Before commencing the journey, fix adjustable tables.
- ▶ Before commencing the journey, rotate all swivel seats in the direction of travel and lock in position. During the journey, the swivel seats must remain locked in place in the direction of travel.
- ▶ It is not permitted to stay in the alcove during the journey.
- ▶ During the journey, persons are only to sit on the permitted seats (see chapter 4). The authorised number of seats is stipulated in the vehicle documents.
- ▶ Seat belts must be worn by all passengers.
- ▶ Fasten your seat belts before the beginning of the journey and keep them fastened during the journey.
- ▶ Always secure children with the children safety equipment prescribed for the respective height and weight.
- ▶ Factory-set three-point safety belts must be used when attaching child restraint systems.
- ▶ The base vehicle is a commercial vehicle (small truck). Adjust your driving technique accordingly.
- ▶ In case of underpasses, tunnels or similar obstacles, note the total height of the vehicle (including the roof load).
- ▶ In winter, the roof must be free of snow and ice before commencing the journey.
- ▶ Check tyre pressure before a journey or every 2 weeks. Wrong tyre pressure causes excessive wear and can lead to damage or even to tyre burst. You can lose control of the vehicle.
- ▶ Do not operate the heater at petrol stations. Danger of explosion!
- ▶ Do not operate the heater in closed spaces. Danger of suffocation!



- ▷ Before commencing the journey, distribute the payload evenly within the vehicle (see chapter 3).
- ▷ When loading the vehicle and when taking a rest from driving, in order to load luggage or food, for example, observe the maximum permissible gross weight and axle loads (refer to vehicle documents).
- ▷ Before commencing the journey, close and lock, if possible, all inner doors, adjustable partition walls, drawers and flaps. Engage the refrigerator door securing device.
- ▷ Before commencing the journey, close windows and skylights.
- ▷ Before commencing the journey, close all external flaps and lock them.
- ▷ Before commencing the journey, remove the external supports and retract the corner steadies or steady legs, which are fitted to the vehicle.
- ▷ Before commencing the journey, put the antenna in park position.
- ▷ During the initial journey and each time after changing a wheel, re-tighten the wheel bolts/wheel nuts after 50 km (30 miles). Subsequently inspect them at regular intervals in order to ensure that they are firmly seated. See chapter 13 for tightening torque.
- ▷ Tyres may not be older than 6 years as the material becomes brittle over time (see chapter 13).
- ▷ When using snow chains, the tyres, wheel suspension and steering are subjected to an additional load. When using snow chains, drive slowly (maximum speed 50 km/h) and only on streets which are completely covered with snow. Otherwise the vehicle could be damaged.

2.4 Towing



- ▶ Care is to be taken when connecting and detaching a trailer. Risk of accident and injury!
- ▶ No persons are to be between the towing vehicle and the trailer during positioning for connecting and detaching.

2.5 Gas system

2.5.1 General instructions



- ▶ Before commencing the journey, when leaving the vehicle or when gas equipment is not in use, close all gas isolator taps and the main isolator tap on the gas bottle.
- ▶ All gas-operated devices (heater, cooker, oven, grill, refrigerator - depending on the equipment) must be switched off for refuelling, on ferries or in the garage. Danger of explosion!
- ▶ Do not use gas-operated devices in closed spaces (e.g. garages). Danger of poisoning and suffocation!
- ▶ Only have the gas system maintained, repaired or altered by an authorised specialist workshop.
- ▶ Have the gas system checked by an authorised specialist workshop according to the national regulations before commissioning. This also applies for not registered vehicles. For modifications to the gas system have the gas system immediately checked by an authorised specialist workshop.



- ▶ The gas pressure regulator and exhaust gas pipes must also be inspected. The gas pressure regulator has to be replaced after 10 years at the latest. The vehicle owner is responsible for seeing that this is carried out.
- ▶ In case of a defect of the gas system (gas odour, high gas consumption) there is danger of explosion! Close regulator tap on the gas bottle immediately. Open doors and windows and ventilate well.
- ▶ If the gas system is defective: Do not smoke; do not ignite any open flames, and do not operate electric switches (light switches etc.).
- ▶ Only the stipulated devices may be connected to internal connections. Do not operate any device outside the vehicle if it is connected to an internal connector.
- ▶ Before using the cooker make sure that there is sufficient ventilation. Open windows or the skylight.
- ▶ Do not use the gas cooker or gas oven for heating purposes.
- ▶ If there are several gas devices, each gas device must have its own gas isolator tap. If individual gas devices are not in use, close the respective gas isolator tap.
- ▶ Ignition safety valves must close within 1 minute after the gas flame has extinguished. A clicking sound is audible. Check function from time to time.
- ▶ The built-in gas devices are exclusively meant for use with propane or butane gas or a mixture of both. The gas pressure regulator as well as all built-in gas devices are designed for a gas pressure of 30 mbar.
- ▶ Propane gas is capable of gasification up to $-42\text{ }^{\circ}\text{C}$, whereas butane gas gasifies at $0\text{ }^{\circ}\text{C}$. Below these temperatures no gas pressure is available. Butane gas is unsuitable for use in winter.
- ▶ Regularly inspect the gas tube fitted to the gas bottle connection for tightness. The gas tube must not have any tears and must not be porous. Have the gas tube replaced by an authorised specialist workshop no later than ten years after the manufacturing date. The operator of the gas system must see to it that the parts are replaced.
- ▶ Due to its function and construction, the gas bottle compartment is a space which is open to the exterior. Never cover or block up the standard forced ventilations. Otherwise gas that is emitted can not be diverted to the outside.
- ▶ The gas bottle compartment must not be used as storage space.
- ▶ Secure the gas bottle compartment against unauthorised access. To do this, lock the compartment.
- ▶ The regulator tap on the gas bottle must be accessible.
- ▶ Only connect gas-operated devices (e.g. gas grill) which have been designed for a gas pressure of 30 mbar.
- ▶ The exhaust gas pipe must be fitted tightly to the heating system and to the vent and must be sealed. The exhaust gas pipe must not show any evidence of damage.
- ▶ Exhaust fumes must be able to escape into the atmosphere unhindered and fresh air must be able to enter unhindered. For this reason, keep the exhaust pipe and intake openings clean and unobstructed (e.g. free from snow and ice). For this reason, no snow walls or aprons may lie against the vehicle.

2.5.2 Gas bottles



- ▶ Gas bottles are only to be transported within the designated gas bottle compartment.
- ▶ Place the gas bottles in vertical position in the gas bottle compartment.
- ▶ Fasten the gas bottles so that they are unable to turn or tilt.
- ▶ Connect the gas tube to the gas bottle without tension.
- ▶ If the gas bottles are not connected to the gas tube, always place the protective cap on top.
- ▶ Close the regulator tap on the gas bottle before the gas pressure regulator or gas tube are removed from the gas bottle.
- ▶ Use your hands only to connect the gas pressure regulator or the gas tube to the gas bottles. Do not use any tools.
- ▶ Only use special gas pressure regulators with a safety valve designed for vehicle use. Other gas pressure regulators are not permitted and cannot meet the demanding requirements.
- ▶ Use the gas pressure regulator defroster if the temperature falls below 5 °C.
- ▶ Use only 11 kg or 5 kg gas bottles. Camping gas bottles with built-in check valve (blue bottle with max. 2.5 or 3 kg content) are can be used in exceptional cases with a safety valve.
- ▶ Use the shortest possible tube lengths (150 cm max.) for external gas bottles.
- ▶ Never block the floor ventilation openings below the gas bottles.

2.6 Electrical system



- ▶ Only allow qualified personnel to work on the electrical system.
- ▶ Prior to carrying out work on the electrical system, switch off all devices and lights, disconnect the battery and disconnect the vehicle from the mains.
- ▶ Only use original fuses with the stipulated values.
- ▶ Only replace defective fuses when the cause of the defect is known and has been remedied.
- ▶ Never bridge or repair fuses.

2.7 Water system



- ▶ Water left standing in the water tank or in the water pipes becomes undrinkable after a short period. Therefore, before each use of the vehicle, thoroughly clean the water pipes and the water tank. After each use of the vehicle completely empty the water tank and the water pipes.
- ▶ In the case of lay-ups lasting more than a week disinfect the water system before using the vehicle (see chapter 11).



- ▷ If the vehicle is not used for several days or if it is not heated when there is a risk of frost, empty the entire water system. Make certain that the water pump is switched off on the panel. Otherwise, the water pump will overheat and may get damaged. Leave the water taps on in central position. Leave the safety/drainage valve (if there is one) and all drain cocks open. Frost damage to appliances, frost damage to the vehicle and deposits in water-carrying components can be avoided in this way.



Chapter overview

This chapter contains important information which has to be noted before commencing your journey or carrying out any tasks before the journey.

The instructions address the following topics:

- keys
- registration
- calculating the payload
- correct loading of the vehicle and bike rack
- load rack
- towing
- retracting and extending the entrance step
- storing the television
- storing the sink cover
- securing add-on parts
- using snow chains

At the end of the chapter there is a checklist which once again summarises the most important points.

3.1 Keys

The following keys are included with your vehicle:

Two keys for

- ignition lock
- driver's and passenger's doors
- fuel tank

Two keys for

- conversion door of the body
- drinking water filler neck
- external flaps

Always deposit a replacement key outside the vehicle. Make a note of the key number. Our authorised dealers and workshops can offer assistance in case of loss.

3.2 Registration

Your motorhome is a vehicle which must be registered. Observe national regulations on registration.

Please remember that certain countries require a separate national code sticker in addition to the EU plate.

3.3 Payload



- ▶ Overloading the vehicle and wrong tyre pressure can cause tyres to burst. You can lose control of the vehicle.
- ▶ Only the maximum permissible gross weight and the mass in a ready-to-drive condition, not the actual weight of the vehicle, is stated in the vehicle documents. For your own safety, we recommend that you have your loaded vehicle (with all passengers, luggage and personal objects) weighed on a public weighbridge before you set out on your journey.
- ▶ Adapt the speed to the payload. The stopping distance is increased if the payload is high.



- ▷ Do not exceed the maximum permissible gross weight stated in the vehicle documents by the payload.
- ▷ Built-in accessories and special equipment reduce the payload.
- ▷ Adhere to the axle load stated in the vehicle documents.

On loading, make sure that the payload's centre of gravity is as low as possible (directly above the floor of the vehicle). Otherwise this may affect the driving characteristics of the vehicle.

Maximum permitted payloads

Description	Load (kg)
Overcab bed	200
Bunk bed	100
Roof load	200
Rear garage and rear storage space	200
Bike rack Double	60
Bike rack Triple	60
E-bike bike rack	100
Load rack (AL-KO)	150
Load rack (SAWIKO)	130

3.3.1 Terms



- ▷ Technically speaking, the term "mass" has now replaced the term "weight". However, "weight" is still the term more frequent in common use. For better understanding, "mass" is therefore only used in the following sections for fixed formulations.
- ▷ All specifications according to EU norm DIN EN 1646-2.

Maximum permissible gross weight in a laden condition

The maximum permissible gross weight in a laden condition is the weight that a vehicle may never exceed.

The maximum permissible overall weight in laden condition consists of the **mass in ready-to-drive condition** and of the **payload**.

In the vehicle documents, the manufacturer has specified the maximum permissible gross weight in a laden condition.

Permitted mass

The permitted mass is the weight specified by the manufacturer for issuing the type approval. The permitted mass must never exceed the maximum permissible gross weight of the loaded vehicle.

Mass in ready-to-drive condition

The mass in ready-to-drive condition is the weight of the ready-to-drive standard vehicle.

The mass in ready-to-drive condition is made up as follows:

- Unladen weight (mass of the empty vehicle) with factory-installed standard equipment
- Driver's weight
- Basic equipment weight

Unladen weight includes lubricants such as oils and coolants which have been filled, the on-board tool set, the spare wheel and a fuel tank which has been filled up to 90 %.

75 kg are calculated for the weight of the driver, regardless of how much the driver really weighs.

Basic equipment includes all equipment and fluids required for safe and proper vehicle use. The weight of the basic equipment includes:

- Water system filled up to 90 % (water tank and pipes)
- Gas bottles filled up to 90 %
- A full heating system
- The power cables for the 230 V power supply
- A full toilet flushing system
- The installation kit for an auxiliary battery if an auxiliary battery can be used

The waste water and sewage tanks are empty.

Example for calculating the basic equipment

Water tank with 60 l (overflow open)	60 kg
Gas bottle (11 kg _{gas} + 5.5 kg _{bottle})	+ 16.5 kg
Boiler with 12 l	+ 12 kg
230 V power cable	+ 4 kg
Installation kit for auxiliary battery	+ 20 kg
Total	= 112.5 kg

In the vehicle documents, the manufacturer specifies the mass in ready-to-drive conditions.

Payload

The payload is made up as follows:

- Conventional load
- Additional equipment
- Personal equipment



- ▷ The vehicle's payload can be increased by reducing the weight in a ready-to-drive condition. To do this, it is allowed for example to empty the fluid containers or to remove the gas bottles.

You will find explanations on the individual components of the payload in the following text.

Conventional load

The conventional load is the weight specified by the manufacturer for the passengers.

Conventional load means: 75 kg are calculated for every seat specified by the manufacturer, regardless of how much the passengers actually weigh. The driver's seat is already included as part of the mass in ready-to-drive condition and must **not** be calculated as part of the conventional load.

In the vehicle documents, the manufacturer specifies the number of seats.

Additional equipment Additional equipment includes accessories and special equipment. Examples of additional equipment include:

- Caravan coupling
- Roof rail
- Awning
- Bike or motorcycle rack
- Satellite unit
- Microwave oven

Chapter 15 lists the weights of the various items of special equipment; they may also be obtained from the manufacturer.

Personal equipment Personal equipment includes all items in the vehicle that are not included in the conventional load or in the additional equipment. For example, personal equipment can include the following:

- Foodstuffs
- Crockery
- Television
- Radio
- Clothes
- Bedding
- Toys
- Books
- Toiletries

No matter where kept, personal equipment also includes:

- Animals
- Bikes
- Boats
- Surfboards
- Sports equipment

For the personal equipment, according to the applicable regulations, the manufacturer must use a minimum weight that is determined according to the following formula:

Formula Minimum weight M (kg) = $10 \times N + 10 \times L$

Explanation N = maximum number of people including the driver, as stated by the manufacturer
 L = total length of the vehicle in metres

3.3.2 Calculating the payload



- ▶ The payload calculation at the factory is partly based on all-inclusive weights. For safety reasons, the maximum permissible gross weight in a laden condition must not be exceeded.
- ▶ Only the maximum permissible gross weight and the mass in a ready-to-drive condition, not the actual weight of the vehicle, is stated in the vehicle documents. For your own safety, we recommend that you have your loaded vehicle (with all passengers, luggage and personal objects) weighed on a public weighbridge before you set out on your journey.

The payload (see section 3.3.1) is the difference in weight between

- Maximum permissible gross weight in a laden condition and
- Vehicle mass complete in a ready-to-drive condition.

Example for calculating the payload

	Mass in kg to be calculated	Calculation
Maximum permissible gross weight according to vehicle documents	3500	
Vehicle mass in a ready-to-drive condition, including basic equipment according to vehicle documents	- 3070	
This results in a permissible payload of	430	
Conventional load e.g.: 3 persons each weighing 75 kg	- 225	
Additional equipment	- 40	
For the personal equipment this results in	= 165	

The calculation of the payload from the difference between the maximum permissible gross weight in laden condition and the mass specified by the manufacturer in ready-to-drive condition is however only a theoretical value.

Only if the vehicle is weighed with full tanks (fuel and water), full gas bottles and complete additional equipment on a public weighbridge, can the actual payload be determined.

To do this, proceed as follows:

- First only drive the vehicle on to the weighbridge with the front wheels and have it weighed.
- Then drive the vehicle on to the weighbridge with the back wheels and have it weighed.

The individual values give the current axle loads. These are important for the correct loading of the vehicle (see section 3.3.3). The sum of these values is the current weight of the vehicle.

The actual payload is the difference between the maximum permissible gross weight in laden condition and the weighed vehicle weight.

This can be used to determine the weight that remains for the personal equipment:

- Determine the weight of the passengers and subtract it from the value for the actual payload.

The result is the weight that is permitted for the actual load of the personal equipment.

3.3.3 Loading the vehicle correctly



- ▶ For safety reasons, never exceed the maximum permissible gross weight in a laden condition.
- ▶ Distribute the load evenly on the left and right sides of the vehicle.
- ▶ Distribute the load evenly on both axles. In doing so, observe the axle loads specified in the vehicle documents. Observe the permissible load-carrying capacity of the tyres (see chapter 13).
- ▶ Heavy loads behind the rear axle can reduce the load on the front axle due to the leverage effect ($\frac{G \cdot A}{R}$). This applies especially to long rear extensions, if a motorbike is transported on the rear carrier or if there is a heavy load in the rear storage space. The release of the front axle negatively affects the driving quality, especially for front-driven vehicles.
- ▶ Store all objects in such a way that they cannot slip.
- ▶ Store heavy objects (awning, tin cans, etc.) close to the axles. Low-lying storage compartments whose doors do not open in the direction of travel are particularly suited for storing heavy objects.
- ▶ Stack light objects (laundry) in the roof storage cabinets.
- ▶ Load the bike rack with bicycles only (max. three units).

Large storage spaces, such as the rear garage, also have room for heavy objects (e.g. motorcycle). This might mean that the axle load on the rear axle is exceeded.

However, the individual axles may not be overloaded under any circumstances. That is why it is important, at which distance to the axles the load is stored.

To distribute the load correctly, you will need a scale, a tape measure, a calculator and some time.

Two simple formulas are needed to calculate the effect of the weight of the load on the axles:

Formulas

$A \times G : R =$ weight on the rear axle

Weight on the rear axle – $G =$ weight on the front axle

Explanation

A = distance between storage compartment and front axle in cm

G = weight of the load in the storage compartment in kg

R = wheelbase of the vehicle (distance between axles) in cm



- ▶ Measure the external distances horizontally from the centre of the front wheel to the centre of the storage compartment or to the centre of the back wheel.

Calculating axle loads:

- Multiply the distance between storage compartment and front axle (A) with the weight of the load in the storage compartment (G) and divide the result by the wheelbase (R). The result is the weight of the load in the storage compartment on the rear axle. Make a note of this weight and of the storage compartment.
- In a second step, subtract the weight in the storage compartment (G) from the weight calculated beforehand. If the result is a **positive** value (example 1), this means that the load on the front axle is **reduced** by this value. If the result is a **negative** value (example 2), this means that the load on the front axle is **increased**. Make a note of this value, too.

- Calculate all storage compartments of the vehicle in the same way.
- In a last step, add all weights calculated for the rear axle to the rear axle load and add (or subtract) all weights calculated for the front axle to (from) the front axle load.
How to determine rear axle load and front axle load is described in section 3.3.2.

If the calculated value exceeds the permissible axle load, the load must be distributed in a different way.

If the load on the front axle is too low, the grip of the tyres on the road is reduced (traction). This applies in particular to vehicles with front wheel drive. In this case, the load must be redistributed, too.

Example calculation

		Example 1	Example 2
Distance to the front axle	A	(A1) 450 (cm)	(A2) 250 (cm)
Weight in the storage compartment	G	x 100 (kg)	x 50 (kg)
Wheelbase of the vehicle	R	÷ 325 (cm)	÷ 325 (cm)
Load on the rear axle (add to the axle load)		138.5 (kg)	38.5 (kg)
Weight in the storage compartment		- 100 (kg)	- 50 (kg)
Load relief to the front axle (subtract from the axle load)		38.5 (kg)	
Load on the front axle (add to the axle load)			-11.5 (kg)

3.3.4 Roof rail and ladder (special equipment)



- ▶ Access the roof only when a roof rail has been fitted. Only climb onto the roof via a ladder.
- ▶ Take care when stepping onto the ladder. There is danger of slipping when the ladder is moist or icy.
- ▶ Take care when stepping onto the roof. There is danger of slipping when the roof is moist or icy.
- ▶ Do not overload the roof. Road behaviour and brake reaction deteriorate as the roof load increases.



- ▷ If the vehicle is equipped with a roof rail, load racks can be mounted on the roof rail for roof loads (e.g. for surfboards, rubber boats or light canoes). Special girder systems are available as accessory. The authorised dealer or service centre will be happy to advise you.
- ▷ The maximum permissible roof load is 200 kg.
- ▷ The maximum localised load is 90 kg/100 cm².
- ▷ Before stepping on to the roof, extensively cover the area you will be treading on. Materials with a smooth or soft surface are suitable, for example, a thick polystyrene panel.
- ▷ Secure roof loads with tension belts. Do not use rubber expanders.
- ▷ Observe the overall height of the vehicle when the roof rack is loaded.



- ▷ The driver's cabin should have a clearly visible notice stating the overall height. This eliminates the need for calculations at bridges and thoroughfares.

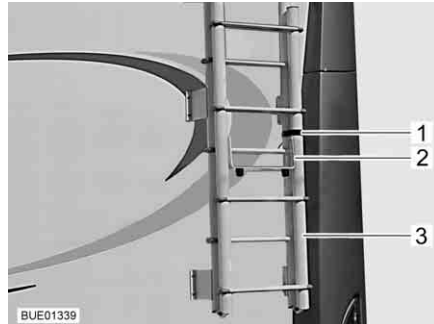

Fig. 1 Ladder folded upwards



Fig. 2 Ladder folded downwards

Climbing on to the roof (rear ladder):

- Open the strap (Fig. 1,1) on the ladder (Fig. 1,3) at the rear of the vehicle.
- Fold out the guard rail (Fig. 1,2).
- Extend the ladder downward.
- Place guard rail with the rubber knobs (Fig. 2,1) up against the back panel of the vehicle.
- Carefully climb the ladder.

Climbing on to the roof (telescopic ladder):

- Carefully place the telescopic ladder (special equipment) against the side of the vehicle.
- Carefully climb the ladder.

3.3.5 Rear garage/rear storage space



- ▶ Do not use storage compartments or rear garages as places for people or animals to stay or sleep in. These spaces are not forced-air ventilated. There is a danger of suffocation due to oxygen deprivation or exhaust from the heater.
- ▶ Observe the permissible axle loads and maximum permissible gross weight when loading the rear garage/the rear storage space.
- ▶ The maximum permitted load of the rear garage/the rear storage space is 200 kg. Do not exceed the permissible rear axle load.
- ▶ Observe: If the rear garage or (depending on the model) the rear storage space is **loaded** to its maximum capacity, this will **reduce the load** on the front axle due to the levering action. The driving quality is impaired.



- ▷ Depending on the vehicle equipment, clamping rails with clamping eyelets are mounted in the rear garage or in the rear storage space. Always secure loads onto the clamping eyelets. Always use tightening straps or lashing nets for securing the load, never rubber expanders.
- ▷ When clamping loads, always check that the clamping eyelets are placed tightly in the clamping rails. If the clamping eyelet is not anchored tightly in the clamping rail, the load may slide or loosen during forcible movements of the steering wheel or when braking.



- ▷ Distribute the load evenly. Excessive spot loads can lead to damages of the floor covering.
- ▷ Use the supporting system offered by your dealer if two-wheelers are transported in the rear garage.

3.3.6 Double floor (Argos 747-2)



- ▶ Observe the permissible axle loads and maximum permissible gross weight when loading the double floor.



- ▷ Distribute the load evenly. Excessive spot loads can lead to damages of the floor covering.

3.3.7 Bike rack (special equipment)



- ▶ Observe the permissible axle loads and maximum permissible gross weight when loading the bike rack.
- ▶ Bicycles may protrude at the side by a maximum of 40 cm, measured from the outer edge of the tail lights. However, a total width of 2.5 m must not be exceeded. Adjust the attachments for the bikes accordingly. The lateral overhang must be marked with a red flag.
- ▶ Load the bike rack with bicycles only (max. three units).
- ▶ Fasten bicycles using the straps provided and check to see that they are secure after you have driven a few kilometres.
- ▶ Check the secure attachment of the bicycles on the bike rack after the first 10 km and then at each break in the journey.
- ▶ Do not use the bike rack as luggage rack or ladder.



- ▷ The bike rack is only to be used for transporting bicycles.
- ▷ The gross weight specified by the manufacturer must not be exceeded.
- ▷ The identification plate and rear lights must not be covered.
- ▷ The maximum permissible payload of the bike rack is 60 kg.
- ▷ When loading the bike rack, observe the centre of gravity. If the bike rack is only loaded with **one** bicycle, position the bicycle as closely as possible to the vehicle wall.
- ▷ Driving with a folded out bike rack without bicycles is not permitted.
- ▷ Before every journey, check:
 - Is the bike rack without bicycles folded in correctly?
 - Are the bicycles securely fastened to the bike rack using the bike rack belts?

Loading the bike rack with bicycles

When loading the bike rack, observe the centre of gravity. The centre of gravity of the bicycles must be as close as possible to the rear wall of the vehicle. The bike rack should always be loaded from the inside to the outside.

Loading the bike rack correctly:

- Depending on the model, fold the bike rack down or pull it out.
- Place the heaviest bicycle directly against the rear wall.
- Place the lightest bicycles in the centre or on the outside of the bike rack.
- Secure the front and rear wheels of each bicycle with the retaining straps on the bike rack.
- In addition, fasten the outermost bicycle depending on the model of the bike rack on the retaining clip or the retaining bracket and to the spacer respectively.

If the bike rack is only loaded with **one** bicycle, position the bicycle as closely as possible to the rear wall.

Bike rack, lowerable



- ▷ Also read the manufacturer's instruction manual.

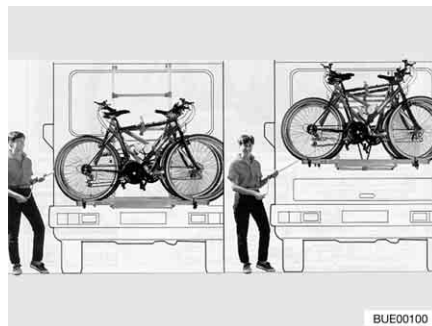

Fig. 3 Bike rack, lowerable

The bike rack (Fig. 3) permits to easily transport 2 bicycles. Expansion for 3 bicycles is possible. A winding system may be used to lift and lower the bike rack approx. 40 cm. The winding system brings the bicycles to gripping height within seconds.

Loading the bicycles:

- Attach the manual crank to the bicycle rack and lower the bike rack to gripping height.
- Place the bicycles on top and secure them with quick straps.
- Fasten the bike-block spacer to the frame of the outermost bicycle.
- Use the manual crank to lift the bicycles back up.

Bike rack, not lowerable

- ▷ Also read the manufacturer's instruction manual.

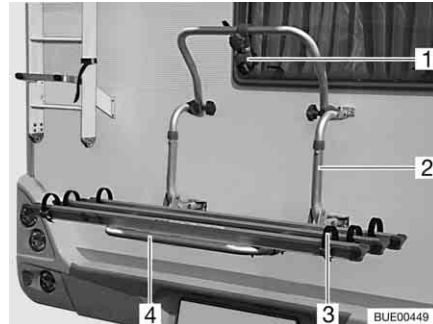

Fig. 4 Bike rack, not lowerable

The bike rack (Fig. 4,2) permits to easily transport 2 bicycles. Expansion for 3 bicycles is possible.

Loading the bicycles:

- Fold the telescopic swivel clip (Fig. 4,4) down.
- Place the bicycles on top and secure them with quick straps (Fig. 4,3).
- Fasten the spacer (Fig. 4,1) to the frame of the outermost bicycle.

3.3.8 Bike/e-bike bike rack (special equipment)

- ▶ Observe the permissible axle loads and maximum permissible gross weight when loading the bike rack.
- ▶ Bicycles may protrude at the side by a maximum of 40 cm, measured from the outer edge of the tail lights. However, a total width of 2.5 m must not be exceeded. Adjust the attachments for the bikes accordingly. The lateral overhang must be marked with a red flag.
- ▶ Lock bike rack in drive position before starting your journey.
- ▶ Fasten bicycles using the straps provided and check to see that they are secure after you have driven a few kilometres.
- ▶ Check the secure attachment of the bicycles on the bike rack after the first 10 km and then at each break in the journey.
- ▶ Do not use the bike rack as luggage rack or ladder.



- ▷ The bike rack is designed only to carry bicycles and electrically assisted bicycles (e-bikes, pedelecs).
- ▷ The gross weight specified by the manufacturer must not be exceeded.
- ▷ The identification plate and rear lights must not be covered.
- ▷ The maximum permissible payload of the bike rack is 100 kg.
- ▷ When loading the bike rack, observe the centre of gravity. If the bike rack is only loaded with **one** bicycle, position the bicycle as closely as possible to the vehicle wall.
- ▷ Before fixing bicycles, check that the retaining arms and the wheel-holders of the bike rack are in the correct position. If necessary, adjust the retaining arm or wheel-holder to fit the bicycle.
- ▷ Driving with a folded out bike rack without bicycles is not permitted.



- ▷ Before every journey, check:
 - Is the bike rack without bicycles folded in correctly?
 - Are the bicycles securely fastened to the bike rack using the bike rack belts?
- ▷ If the bicycle rack is equipped with a charging unit:
 - Are the charging cables securely fastened? Otherwise, charging cables can tear off.

Loading the bike rack with bicycles

When loading the bike rack, observe the centre of gravity. The centre of gravity of the bicycles must be as close as possible to the rear wall of the vehicle. The bike rack should always be loaded from the inside to the outside.

Loading the bike rack correctly:

- Place the heaviest bicycle directly against the rear wall.
- Position the lighter bicycle on the outside of the bike rack.
- Secure the front and rear wheels of each bicycle with the retaining straps on the bike rack.
- Fix every bicycle to the retaining arm.

If the bike rack is only loaded with **one** bicycle, position the bicycle as closely as possible to the rear wall.

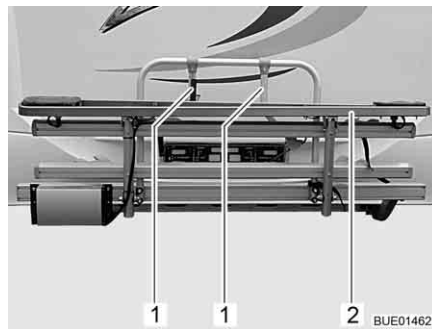

Fig. 5 E-bike bike rack



Fig. 6 Positioning of e-bikes

- Loosen the strap and fold the e-bike bike rack (Fig. 5,2) down.
- Lift the first e-bike onto the bike rack and place it on the wheel-holders (with the front wheel pointing left).
- Swing out the shorter retaining arm (Fig. 5,1) and secure the e-bike's front frame tube (Fig. 6,1) with straps.
- Using the straps, fix both wheels to the wheel-holders.
- Lift the second e-bike onto the bike rack and place it on the wheel-holders (with the front wheel pointing right).
- Swing out the longer retaining arm (Fig. 5,1) and secure the e-bike's front frame tube (Fig. 6,1) with straps.
- Using the straps, fix both wheels to the wheel-holders.
- If necessary, place third e-bike on the wheel-holders and secure it.
- Check that all bicycles are securely fastened.

3.3.9 Removable load rack AL-KO (special equipment)



- ▶ Do not exceed the rear axle load.
- ▶ Heavy loads behind the rear axle can reduce the load on the front axle due to the leverage effect ($\frac{1}{2} \frac{1}{2}$). This applies especially to long rear extensions, if a motorbike is transported on the rear carrier or if there is a heavy load in the rear storage space. The release of the front axle negatively affects the driving quality, especially for front-driven vehicles.
- ▶ Always make sure to store the load roadworthy and secure it against falling.
- ▶ The load may not jut out beyond the maximum width of the vehicle. The lighting and the official licence plate on the load rack may not be covered by the load.
- ▶ Always mount or dismount the load rack with 2 persons.
- ▶ Only mount the unloaded load rack.



- ▷ The load rack and caravan coupling may not be used simultaneously.



- ▷ The load rack has a EG type approval number.
- ▷ Have your dealer or service centre install the load rack.
- ▷ Observe the country-specific regulations.
- ▷ Also read the manufacturer's instruction manual.

The load rack permits transport of a load (e.g. a motorcycle or a motor scooter) weighing up to 150 kg. Always remove the load rack after use.

Installation:

- Apply the handbrake.
- Insert the spars in the holders on the left and right side of the frame and push them in completely.
- Close the clamping levers. To do so, press and rotate the clamping levers.
- Close the clamp fasteners on the support tubes.
- On the left and the right side, put a locking lever through the holes in the holders and in the spars, and secure them with cotter pins.
- Connect the electrics between the load rack and the vehicle.
- Check the fixing of the load rack on the vehicle and the functioning of the lamps.

Removal:

- Apply the handbrake.
- Disconnect the electrics between the load rack and the vehicle.
- On the left and the right side, remove the cotter pin from the locking levers and pull locking levers out off the holders.
- Open the clamp fasteners on the support tubes.
- Open the clamping levers. To do so, press and rotate the clamping levers.
- Remove the spars from the holders on the frame.

Requirement for mounting

If the load rack is to be mounted, two galvanised tube mounts must be attached to the left and right side of the vehicle frame. They are designed to hold the load rack.

3.3.10 Load rack SAWIKO (special equipment)



- ▶ Do not exceed the rear axle load.
- ▶ Heavy loads behind the rear axle can reduce the load on the front axle due to the leverage effect ($\frac{m}{l} \cdot \frac{1}{2}$). This applies especially to long rear extensions, if a motorbike is transported on the rear carrier or if there is a heavy load in the rear storage space. The release of the front axle negatively affects the driving quality, especially for front-driven vehicles.
- ▶ Always make sure to store the load roadworthy and secure it against falling.
- ▶ The load may not jut out beyond the maximum width of the vehicle. The lighting and the official licence plate on the load rack may not be covered by the load.



- ▷ The load rack and caravan coupling may not be used simultaneously.



- ▷ An entry must be made in the vehicle documents in order to attach a load rack. The required documents are enclosed with the load rack.
- ▷ Have your dealer or service centre install the load rack.
- ▷ Observe the country-specific regulations.
- ▷ Also read the manufacturer's instruction manual.

The load rack permits transport of a load weighing up to 130 kg. For the transport of the load different attachments are available. They are e.g. bike rack or a transport box. Our authorised dealers and service centres will be happy to advise you.

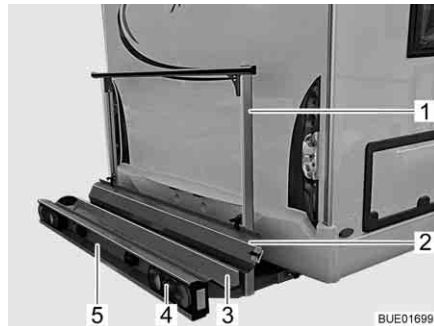

Fig. 7 Load rack

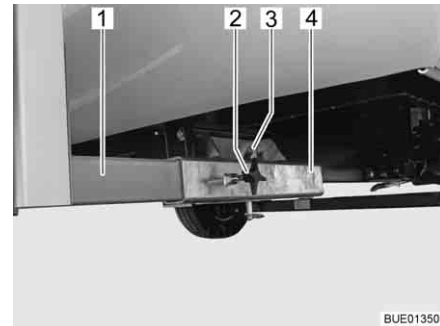

Fig. 8 Attachment to vehicle

The load rack (Fig. 7) permits transport of a motorcycle or a motor scooter weighing up to 130 kg.

Scope of delivery

The following parts belong to the scope of delivery:

- Rack trough (Fig. 7,3) and retaining clip (Fig. 7,1) with attachment to vehicle (Fig. 8)
- Rear lights (Fig. 7,4)
- Vehicle licence plate light (Fig. 7,5)
- 13-pole Jäger System plug
- Ramp (Fig. 7,2)

Attachment to vehicle

The two side members (Fig. 8,1) of the load rack are fixed to the floor of the vehicle by means of tommy screws (Fig. 8,2) on the square drives (Fig. 8,4). The load rack is secured by a bolt (Fig. 8,3) with locking ring.

Entry in the vehicle documents

Have your dealer or service centre install the add-on parts. They will also take care of all the formalities for you.

3.4 Towing



- ▶ Care is to be taken when connecting and detaching a trailer. Risk of accident and injury!
- ▶ No persons are to be between the towing vehicle and the trailer during positioning for connecting and detaching.
- ▶ Observe the permissible nose weight and rear axle load of the motorhome. Refer to the vehicle documents for the rear axle load.



- ▷ Trailer with an overrun brake: Do not connect or detach trailer with the overrun brake on.
- ▷ Caravan coupling with detachable ball neck: If the ball neck is mounted incorrectly, there is the danger of the trailer breaking away. Observe the instruction manual for the caravan coupling.

Depending on the model, different nose weights may apply for the caravan couplings. Refer to the following table for the respective permissible nose weight.

Model	Permissible nose weight
SAWIKO MT019	75 kg
SAWIKO (other)	100 kg
Linnepe	100 kg
AL-KO	80 kg

3.5 Caravan coupling (special equipment)



- ▶ When mounting a caravan coupling, see the vehicle documents for information on maximum nose weight and caravan load.
- ▶ Retighten the caravan coupling fixing screws after 1000 operating hours.



- ▷ The load rack and caravan coupling may not be used simultaneously.



- ▷ An entry must be made in the vehicle documents in order to attach a caravan coupling. The required documents are enclosed with the caravan coupling.
- ▷ Also read the manufacturer's instruction manual.



Fig. 9 Caravan coupling, rigid



Fig. 10 Caravan coupling, detachable

Entry in the vehicle documents

Have your dealer or service centre install the add-on parts. They will also take care of all the formalities for you.

3.6 Electrically operated entrance step



- ▶ Before commencing the journey and after short interruptions of the journey, ensure that the entrance step is completely retracted.
- ▶ Do not stand in the direct range of the entrance step while it is being retracted or extended.
- ▶ Do not step on the entrance step until it has extended completely. There is a risk of injury.
- ▶ Do not under any circumstances raise or lower persons or loads with the entrance step.



- ▷ Take note of the different step heights and make certain that the ground is firm and even when exiting.
- ▷ Do not grease or lubricate the pivot bearing and joints of the entrance step (see chapter 11).



- ▷ The button to operate the entrance step is located on the inside of the vehicle in the area of the conversion door.
- ▷ If the entrance step is not retracted and locked in place correctly, a red indicator lamp lights up on the dashboard when the ignition is switched on.
- ▷ Follow the warning notice on the entrance step.

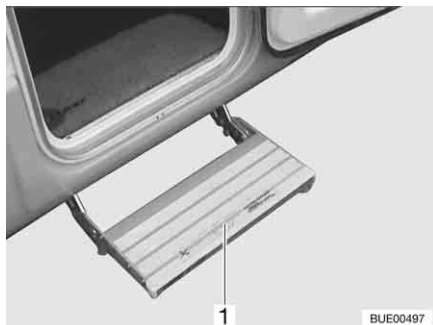

Fig. 11 Entrance step

The vehicles have a one-step, electrically extendable entrance step (Fig. 11,1).

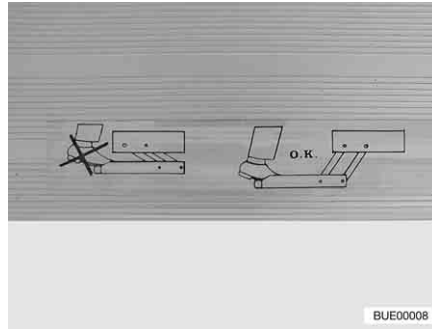

Fig. 12 Warning notice for entrance step

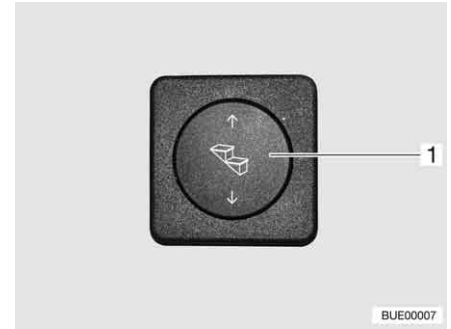

Fig. 13 Operating button for entrance step

Before stepping on the entrance step, fully extend it (Fig. 12).

- Extending:*
- Press the rocker button (Fig. 13,1) down and hold it pressed (at least 3 seconds) until the entrance step has extended completely.
- Retracting:*
- Press the rocker button (Fig. 13,1) up until the entrance step has retracted completely.

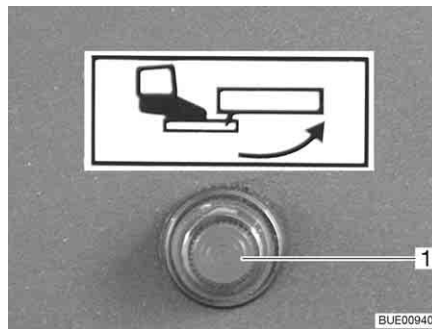

Fig. 14 Indicator lamp

When the ignition is switched on and the entrance step is extended, an indicator lamp (Fig. 14,1) is illuminated on the dashboard.

3.7 TV unit (special equipment)



- ▶ Before commencing the journey, place and secure the flat screen and screen support in the initial position. If the screen holder is installed in a TV cabinet: Close TV cabinet.
- ▶ Before commencing the journey, ensure that the antenna is in park position. Danger of accidents! Park position means: The antenna points towards the back, is fully lowered and is locked in this position.



- ▷ Further information on positioning the flat screen can be obtained from chapter 6.

3.8 Sink and drain basin covers



- ▶ In the event of an accident or emergency braking, the loose sink (Fig. 15,1) and drain basin covers could injure the occupants of the vehicle. Before commencing the journey, take the loose covers off and store them securely in the kitchen unit or wardrobe.



Fig. 15 Sink cover (example)

3.9 Securing add-on parts



- ▶ In the event of an accident or emergency braking, loose add-on parts could injure the occupants of the vehicle. Before setting off, secure loose add-on parts in the holders provided or stow them in a secure place inside the vehicle.



- ▷ Unsecured flaps and doors can spring open during the journey and damage parts of the interior. Secure all flaps and doors before setting off.

Add-on parts

Add-on parts include bed extensions, ladders or table extensions.



Fig. 16 Bed extension in the rear garage



Fig. 17 Access ladder in the wardrobe

Securing add-on parts:

- Place the add-on parts (Fig. 16,1 and Fig. 17,1) in the holders provided and secure them with the available means of attachment.
- If no holder is provided for the add-on part, stow the add-on part in a storage space the doors of which cannot be opened in the direction of travel (e.g. wardrobe or rear storage space).

Doors and flaps

Doors are, for example, inner doors or partition walls. See section 6.4 for furniture flaps.



Fig. 18 Shower partition

Securing doors: ■ Secure doors or partition walls (Fig. 18,1) with the locks or means of securing provided.

3.10 Snow chains (special equipment)



- ▷ Only mount snow chains if there is a clearance of at least 50 mm between the tyres and the vehicle body.
- ▷ When using snow chains, the tyres, wheel suspension and steering are subjected to an additional load. When using snow chains, drive slowly (maximum speed 50 km/h) and only on streets which are completely covered with snow. Otherwise the vehicle could be damaged.
- ▷ Observe the fitting instructions issued by the manufacturer of the snow chains.
- ▷ Do not fit snow chains on alloy wheel rims.

Only use suitable snow chains:

Tyre size	Snow chain size
215/70 R 15 C	230
225/75 R 16 C	245

The use of snow chains is subject to the legal regulations of the individual countries.

- Always mount snow chains to the drive wheels.
- After a few metres, check the tension of the snow chains.

3.11 Road safety



- ▶ Check tyre pressure before a journey or every 2 weeks. Wrong tyre pressure causes excessive wear and can lead to damage or even to tyre burst. You can lose control of the vehicle.

Before commencing the journey, work through the checklist:

Base vehicle

No.	Checks	Checked
1	All vehicle documents are on board	
2	Tyres in proper condition	
3	Vehicle lighting, brake lights and reversing lights function	
4	Oil levels for engine, gearbox and power steering controlled	
5	Coolant and fluid for windscreen washers filled up	

No.	Checks	Checked
6	Brakes function	
7	Brakes react evenly	
8	When braking, the vehicle remains in the lane	

Housing body, outside

9	Awning completely retracted	
10	Roof free of snow and ice (in winter)	
11	External connections and lines disconnected and stored away	
12	External supports removed	
13	Fitted supports retracted and fixed in place	
14	Wheel chocks removed and stored away	
15	Entrance step is stored securely or retracted	
16	External flaps closed and locked	
17	Conversion door locked	
18	Overall height of the vehicle including roof rack when loaded measured and noted. Keep the height information close at hand in the driver's cabin	

Housing body, inside

19	Windows and skylights closed and locked	
20	Television removed from the support and securely stored	
21	Flat screen secured	
22	Television antenna retracted (if one is built in)	
23	Loose parts and add-on parts stored away or fixed in position	
24	Open storage spaces empty	
25	No gas cartridges or other easily flammable materials stored in the roof cupboard of the awning light	
26	Store sink and drain basin covers securely	
27	Refrigerator door secured	
28	Refrigerator set to 12 V operation	
29	All drawers and flaps closed	
30	All inner doors closed and all adjustable partition walls open and secured	
31	Children's seats mounted to seats with three-point safety belts	
32	Swivel seat locking device for driver's seat and front passenger's seat locked	
33	Shades in the driver's cabin opened and secured	

Gas system

No.	Checks	Checked
34	Gas bottles firmly fixed in the gas bottle compartment so that they are unable to turn	
35	If the gas bottles are not connected to the gas tube, always place the protective cap on top	
36	If there is no supplied crash protection unit: Regulator tap on the gas bottle and gas isolator taps are closed	

Electrical system

37	<p>Check the battery voltage of the starter and living area battery (see chapter 8). If the panel indicates that the battery voltage is too low, the respective battery will need to be recharged. Observe the notes and instructions in chapter 8</p> <p> ▷ Commence journey with fully charged starter and living area batteries.</p>	
----	--	--

Chapter overview

This chapter contains instructions on how to drive the motorhome.

The instructions address the following topics:

- reversing camera with LCD monitor
- driving speed
- brakes
- pneumatic spring
- seat belts
- child restraint system
- seats and headrests
- seating arrangement
- Roman shades in the driver's cabin
- filling the tank

4.1 Driving the motorhome



- ▶ The base vehicle is a commercial vehicle (small truck). Adjust your driving technique accordingly.
- ▶ Before commencing the journey and after short interruptions of the journey, ensure that the entrance step is completely retracted.
- ▶ A seat belt is fitted for each seat which is permitted for travel. Please keep your seat belt fastened during the journey.
- ▶ Never open your seat belts when travelling.
- ▶ Passengers must remain in the seats provided.
- ▶ The doors must remain locked.
- ▶ Avoid braking with a jerk.
- ▶ If a navigation system is used, only change the destination when the vehicle is stationary. Drive to a car park or stop in a safe area when changing the destination.
- ▶ Do not play DVDs using the monitor of the navigation system during the journey.



- ▷ Drive slowly on poor roads.
- ▷ Take extreme care when driving onto ferries, crossing uneven roads and driving in reverse. Because of the relatively large overhang, larger vehicles might swing out and "touch ground" in unfavourable conditions. This can cause damage to the underbody or to parts fitted there.



- ▷ If an accident occurs as a result of these instructions not being observed, the manufacturer will not be responsible for damages caused.
- ▷ The safety measures stipulated in chapter 2 have to be observed.
- ▷ If a reversing camera is installed in the vehicle, the camera is automatically switched on when driving in reverse gear.

4.2 Reversing camera (partially special equipment)



Fig. 19 Reversing camera with infrared illumination

A reversing camera (Fig. 19,1) is installed in the vehicle.

When it is dark, the infrared LEDs of the reversing camera (Fig. 19,1) illuminate the field of view.



Fig. 20 LCD monitor (Pioneer)

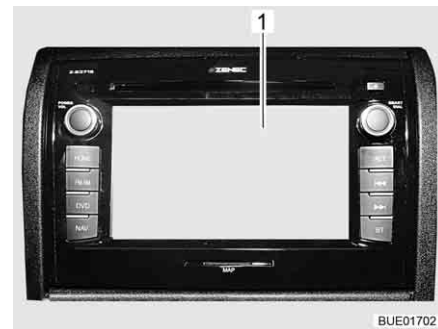

Fig. 21 LCD monitor (Zenec)

The image of the reversing camera is fed into the central multimedia/navigation system and shown on the existent LCD monitor (Fig. 20,1 or Fig. 21,1).

If the engine is running or the ignition is switched on, the reversing camera and LCD monitor switch themselves on automatically when you engage reverse.

If the engine is running or the ignition is switched on, the reversing camera and LCD monitor can also be switched on manually via a pushbutton or a switch on the display.

The system can also be switched off via a pushbutton or the "OFF" button on the display.



- ▷ Further information can be obtained in the manufacturer's instruction manual.

4.3 Driving speed



- ▶ The vehicle is equipped with a powerful engine. This means there are sufficient reserves in difficult traffic situations. This high power enables a high maximum speed and requires above-average driving ability.
- ▶ The vehicle provides a large contact surface for wind. A sudden cross-wind can be especially dangerous.
- ▶ Uneven or one-sided loading affects road performance.



- ▶ Driving on unknown streets, you may encounter hazardous road conditions and unexpected driving situations. Therefore, in the interest of safety, make sure your driving speed is appropriate to any given driving situation and environment.
- ▶ Adhere to the national legal speed limits.

4.4 Brakes



- ▶ Have defects on the braking system immediately remedied by an authorised specialist workshop.



- ▷ Avoid block brakings. Block braking gives the tyres "brake plates" of varying strength. This reduces driving comfort. It might even make the tyres unserviceable.

Before each journey

Before each journey, check by means of a braking test:

- Do the brakes function?
- Do the brakes react evenly?
- Does the vehicle remain in the lane when braking?

4.5 Pneumatic spring (special equipment)

4.5.1 General instructions



- ▶ Overloading of the vehicle cannot be observed visually in the case of a pneumatic spring with automatic levelling.
Never exceed the axle load nor the maximum permissible gross weight.
- ▶ Never use the pneumatic spring to lift the vehicle for servicing (e.g. changing the wheel).
- ▶ Only lift or lower the vehicle when stationary or at a speed of up to 25 km/h (15 mph).
- ▶ Only operate the remote control, if people or objects are not in the working area under the vehicle.
- ▶ Do not allow children to play with the system.
- ▶ Only drive at a steady, low speed if there is a fault with the pneumatic spring and have the fault immediately repaired by an authorised specialist workshop.



- ▷ Do not operate the brake pedal during lifting or lowering of the vehicle. This prevents chassis tension.
- ▷ In the case of long periods of inactivity, the vehicle level may gradually become lower. This can damage the air bellows. The following measures can therefore be adopted in the event of long periods of inactivity:
 - Use steady legs.
 - Fill the air bellows once a week with compressed air.

A pneumatic spring keeps the vehicle at the same driving level in every loading condition. Additionally, different functions are operated manually. The increase of ground clearance simplifies e.g. driving onto ferries (bigger gradient angle).

4.5.2 Rear axle pneumatic spring



- ▶ In the following cases, do not drive faster than 25 km/h (15 mph):
 - While the vehicle is being raised.
 - While the vehicle is being lowered.
 - When the driving level is raised or lowered.
 Then drive at a higher speed once the driving level is set.

The different functions of the pneumatic spring can be operated manually via the remote control buttons.



- ▷ When the vehicle is stationary, the button functions are only available if the ignition is switched on.

When driving, the button functions are only available for speeds under 25 km/h (15 mph).



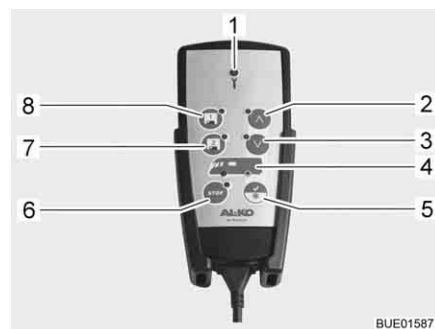

- ▷ If the speed exceeds 25 km/h (15 mph), the driving level is controlled automatically.



- 1 Indicator lamp
- 2 Raising the level
- 3 Lowering the level
- 4 Axle indicator
- 5 Driving level
- 6 Stop button
- 7 Storage 2
- 8 Storage 1

Fig. 22 Remote control

The following functions can be selected via the buttons:

Function	Button	Display	Signification
Start the system (switch on the ignition)		LED lights up for a second	System ready
		LED lights up	Vehicle in driving level
Set driving level	 Press shortly	LED lights up	Vehicle is set to driving level
Raise the vehicle	 Press until the desired level has been reached	Button blinks	Vehicle is raised
	Release	Button lights up	Level reached
	 Press shortly	Button blinks Button lights up	Vehicle is raised Highest level reached

Function	Button	Display	Signification
Lower the vehicle	Press until the desired level has been reached	Button blinks	Vehicle is lowered
	Release	Button lights up	Level reached
	Press shortly	Button blinks	Vehicle is lowered
		Button lights up	Lowest level reached
Save level	or Press	-	Set level
	or Press	Sound is emitted	Setting is saved
Control saved level	or Press shortly	Button blinks	Level is set
		Button lights up	Level reached
Emergency stop	Press once (during functional process)	-	All functions are immediately interrupted
	Press twice	-	System is reactivated
Switch the system off	Press once	Button lights up	System is switched off
Switch the service mode on/off (vehicle in park but with the ignition still switched on)	Press shortly	Button lights up	Service mode switched on
	Press again	Button goes out	Service mode switched off



▷ Further information can be obtained in the manufacturer's instruction manual.

4.5.3 Front and rear axle pneumatic spring



- ▶ Do not exceed the speed limit while the vehicle's level is being changed or when the vehicle is **not** set at the driving level. Once the vehicle is set at the driving level, you may drive at a faster speed.

The different functions of the pneumatic spring can be operated manually via the remote control buttons.















- ▷ When the vehicle is stationary, the button functions are only available if the ignition is switched on. When travelling, the button functions are only available up until a particular speed limit.
- ▷ If the speed limit is exceeded, the driving level is controlled automatically.











Fig. 23 Remote control

Button	Description	Speed limit
1	Indicator lamp	-
2	Off-road position	Up to 25 km/h (15 mph)
3	Parking position	Up to 25 km/h
4	Raising the level	Up to 5 km/h (3 mph)
5	Lowering the level	Up to 5 km/h
6	Axle indicator	Up to 5 km/h
7	Driving level	Up to 25 km/h
	Manual operation	Up to 5 km/h
8	Stop button	Up to 25 km/h
9	Automatic level	-
10	Lateral inclination	Up to 5 km/h
11	Lowering the front	Up to 25 km/h
12	Lowering the rear	Up to 25 km/h

The following functions can be selected via the buttons:

Function	Button	Display	Signification
Start the system (switch on the ignition)		LED lights up for a second	System ready
		Two LEDs light up	Vehicle in driving level
Set driving level	 Press shortly	Both LEDs light up	Vehicle is set to driving level
Automatic level ¹⁾	 Press	Button blinks	Vehicle is aligned horizontally
		Button lights up for 10 seconds	Best possible position is reached
	 Press shortly	-	End the function Vehicle is reset to driving level
Axle is selected for manual use	 Press multiple times (approx. 3 seconds), until the desired axle is selected	 Axle's LED lights up	Axle is selected
Lift the vehicle (axle is selected)	 Press until the desired level has been reached	Button blinks	Vehicle is raised
	Release	Button lights up	Level reached
	 Press shortly	Button blinks	Vehicle is raised
		Button lights up	Highest level reached
Lower the vehicle (axle is selected)	 Press until the desired level has been reached	Button blinks	Vehicle is lowered
	Release	Button lights up	Level reached
	 Press shortly	Button blinks	Vehicle is lowered
		Button lights up	Lowest level reached
Off-road position (high driving position)	 Press shortly	Button blinks	Vehicle is raised
		Button lights up	Level reached
Parking position (low driving position)	 Press shortly	Button blinks Beeping noise while the function is active	Vehicle is lowered
		Button lights up	Level reached

Function	Button	Display	Signification
Lower the rear (easier to load)	 Press shortly	Button blinks	The rear of the vehicle is lowered
		Button lights up	Lowest possible level reached
Lower the front (large ground clearance in the rear area)	 Press shortly	Button blinks	The front of the vehicle is lowered
		Button lights up	Lowest possible level reached
Lateral inclination (emptying the tank)	 Press until the desired angle has been reached	Button blinks	Vehicle inclines
	Release	Button lights up	Maximum inclination angle has been reached
	 Press shortly	-	End the function Vehicle is reset to driving level
Emergency stop	 Press once (during functional process)	-	All functions are immediately interrupted
	 Press twice	-	System is reactivated
Switch the system off	 Press once	Button lights up	System is switched off
Switch the service mode on/off (vehicle in park but with the ignition still switched on)	 Press shortly	Button lights up	Service mode switched on
	 Press again	Button goes out	Service mode switched off

1) This function is available for another 6 minutes after the ignition has been switched off



▷ Further information can be obtained in the manufacturer's instruction manual.

4.6 Seat belts

4.6.1 General

The vehicle is equipped with seat belts in the living area on the seats for which seat belts are compulsory by law. National regulations apply seat-belt fastening.



- ▶ Fasten your seat belts before the beginning of the journey and keep them fastened during the journey.
- ▶ Do not damage or trap belts. Have damaged seat belts changed by an authorised specialist workshop.
- ▶ Do not alter the belt fixing devices, automatic seat belt winders and the belt clips.
- ▶ Only use one seat belt for **one** adult person.
- ▶ Do not belt in objects together with persons.
- ▶ Seat belts are not sufficient for persons who are less than 150 cm tall. In these cases use additional restraining devices. Observe test certificate.
- ▶ Factory-set three-point safety belts must be used when attaching child restraint systems.
- ▶ After an accident, replace the seat belts.
- ▶ During the journey, do not tilt the backrest too far backwards. Otherwise the functionality of the seat belt is no longer guaranteed.

4.6.2 Fastening the seat belt correctly



- ▶ Do not twist the belt. The belt must be positioned smoothly against the body.
- ▶ When fastening the seat belt, adopt the correct sitting position.

The seat belt is correctly fastened when the lap belt passes below your stomach and across the hip bone. The shoulder belt must pass across the chest and shoulder (not across your neck). The belt must always be taut against your body. Any bulky or padded clothing should therefore be removed before you start your journey.

4.7 Child restraint systems



- ▶ When travelling, secure children under 13 years of age that are smaller than 150 cm, with a suitable and officially approved child restraint system.
- ▶ Factory-set three-point safety belts must be used when attaching child restraint systems.
- ▶ Fasten the childrens' seat belts before commencing the journey and make sure that their seat belts are kept fastened during the journey.
- ▶ Use a rear-facing child restraint system ("reboard system") only when the front and side air bags on the passenger side are switched off. Observe the separate operating instructions of the chassis manufacturer and the warning notices in the vehicle. If no rear-facing child restraint system is in use, switch the airbags back on again.

Child restraint systems are divided into five classes:

Class	Body weight	Approximate age
0	Up to 10 kg	Up to 9 months
0+	Up to 13 kg	Up to 18 months
I	9 kg to 18 kg	9 months to 4 years
II	15 kg to 25 kg	3 years to 7 ½ years
III	22 kg to 36 kg	6 years to 12 years

The following table shows, which child restraint systems can be used on which seats.

Seats	Age groups			
	< 10 kg (0-9 months)	< 13 kg (0-24 months)	9-18 kg (9-48 months)	15-36 kg (4-12 years)
Front passenger's seat	X	U ¹⁾	U ¹⁾	U ¹⁾
Second and third row of seats	U ²⁾	U	U	U
Here, the following meanings apply:				
U:	Suitable for "universal" restraint systems which are authorised for this age group.			
UV:	Suitable for forward-facing "universal" restraint systems which are authorised for this age group.			
X:	Seat is not suitable for children in this age group.			

1) This only applies without airbag or with deactivated airbag.

2) Only possible in the respective seat if the distance between the seat and the table is large enough or if the table has been removed.

4.8 Pilot seats for the driver's and front passenger's seats



- ▶ Before commencing the journey, rotate all swivel seats in the direction of travel and lock in position.
- ▶ The seats must remain fixed in position during the journey and are not to be rotated.



- ▷ Before rotating the seats in the pitched vehicle, always apply the hand-brake.



- ▷ The driver's seat and the front passenger's seat are part of the base vehicle. The adjustment of the seats is described in the instruction manual of the base vehicle.

4.9 Seat heater (special equipment)



- ▷ The seat heater only works when the ignition is switched on.

Depending on equipment levels, the driver's seat and the front passenger's seat may have a 2-level seat heater.



Fig. 24 Switch for seat heater

Switching on the seat heater:

- Press the switch (Fig. 24,1) at the back on the left side of the seat console.
 - For minimal heating: Press the switch so that it is in the down position.
 - For the highest heat level: Press the switch so that it is in the up position.

The LED (Fig. 24,2) comes on when the seat heater is in use.

Switching off the seat heater:

- Set switch (Fig. 24,1) to the middle position. The LED goes out.

4.10 Headrests



Fig. 25 Bench headrest

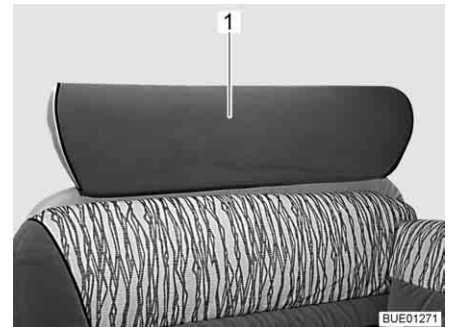

Fig. 26 Bench headrest (alternative)

Before commencing the journey, adjust the headrests (Fig. 25,1) or the headrest (Fig. 26,1) so that the back of the head is supported at approximately ear height.



Fig. 27 Symbol "Adjust headrests"

Push the headrests upwards or downwards by hand.

4.11 Seating arrangement



- ▶ During the journey, persons are only to sit on the permitted seats. The authorised number of seats is stipulated in the vehicle documents.
- ▶ During the journey sitting on the divans is not permitted.
- ▶ Seat belts must be worn by all passengers.



Fig. 28 Symbol "Do not use seat during the journey"

Seats which may not be used during the journey are equipped with a sticker (Fig. 28).

4.12 Roman shade in the driver's cabin

4.12.1 Pleated Roman shades



- ▶ When on the move, the Roman shades for the windscreen, driver's window and the front passenger's window respectively must be completely removed.



Fig. 29 Pleated Roman shades

Removing the pleated shade:

- Open the snap fasteners (Fig. 29,1), loosen the magnetic strips and detach the pleated shade from the window (shown here on the passenger window).
- Stow away the pleated shades in the living area.

4.12.2 Roman shades, Remis (special equipment)



- ▶ While travelling, the Roman shades for the windscreen, driver's window and front passenger's window must be open, in a fixed position and secured.



Fig. 30 Roman shade for the windscreen

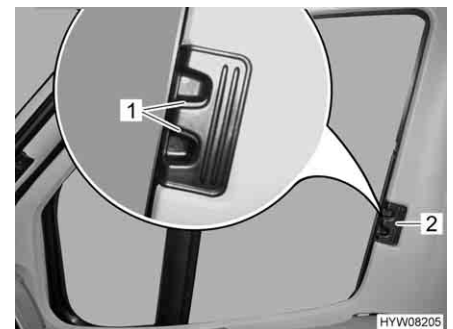

Fig. 31 Roman shade for driver's and passenger's window

Securing:

- Use the handle (Fig. 30,2) to pull the two halves of the Roman shade for the windscreen outwards as far as they will go. When doing so, move the handle horizontally in the direction of the locking recess.
- Allow the release handles (Fig. 30,1) to engage.
- Use handle (Fig. 31,2) to push in the Roman shades for the driver's and passenger's window as far as possible.
- Allow the release handles (Fig. 31,1) to engage.

4.13 Refuelling



- ▶ All gas-operated devices must be switched off for refuelling (heater, cooker, oven, grill, refrigerator - depending on the equipment). Danger of explosion!



- ▷ The fuel filler neck is part of the base vehicle.
- ▷ The fuel filler neck is labelled with the word "Diesel".

Refer to the instruction manual for the base vehicle for the position of the fuel filler neck.

Chapter overview

This chapter contains instructions on how to pitch the vehicle.

The instructions address the following topics:

- handbrake
- entrance step
- ramps
- wheel chocks
- operation of the supports
- 230 V connection
- refrigerator
- aligning the antenna
- retracting and extending the awning



- ▷ Pitch the vehicle so that it is as horizontal as possible. Use ramps where necessary. Otherwise, the water from the shower tray will not be able to drain properly.
- ▷ Secure the vehicle to prevent it from rolling.
- ▷ Animals (especially mice) can cause great damage to the interior of the vehicle. To prevent this from happening, regularly check the vehicle for damages or animal traces after pitching.

5.1 Handbrake

Firmly apply the handbrake when parking the vehicle.

5.2 Entrance step

In order to exit the vehicle, first fully extend the entrance step. Observe the indicator lamp on the dashboard.

For operating the entrance step, see section 3.6.

5.3 Ramps



- ▷ Ramps are not included in the scope of delivery. Different models are available from accessory shops.

To enable the vehicle to be parked on the level, ramps can be used for height compensation when the vehicle is parked on a hill or on uneven ground.

5.4 Wheel chocks

When parking the vehicle on slopes or inclines use the wheel chocks.

If the maximum permissible gross weight of the vehicle exceeds 4 tonnes, wheel chocks must be used when parking on gradients. The wheel chocks are provided as standard for vehicles with a maximum permissible gross weight exceeding 4 tonnes.

5.5 Supports

5.5.1 General instructions



- ▶ The steady legs must not be used to jack up the vehicle in order to work beneath it, e.g. to change a wheel or carry out maintenance work.
- ▶ Whilst the vehicle is in a jacked up position, persons must not lie down under it.



- ▷ Always apply the handbrake before extending the steady legs.
- ▷ Do not use the fitted supports as a vehicle jack. They supports are only for stabilising the parked vehicle to prevent the rear axle from bottoming out.
- ▷ When pitching the vehicle, ensure that the supports are evenly loaded.
- ▷ Before driving away, wind up the supports as far as they can go, fully retract and secure them.



- ▷ When the ground is soft, place a pad or block under the supports in order to prevent the vehicle from sinking into the ground.
- ▷ Pitch the vehicle so that it is as horizontal as possible. Otherwise, the water from the shower tray will not be able to drain properly.

5.5.2 Steady legs (SAWIKO) (partially special equipment)



- ▷ Depending on the model, the hexagonal nut has a joint, which can be used to bring the attached socket spanner into a more convenient position for turning.

In order to ensure their correct function, clean and grease the interior tubes of the steady legs regularly.

The length of the steady legs can be adjusted according to the model.

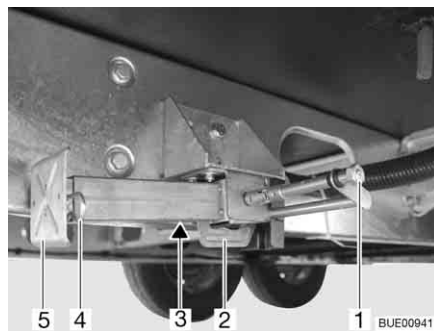

Fig. 32 Steady leg

Extending:

- Place the socket spanner on the hexagonal nut (Fig. 32,1) and rotate until the steady leg is in a perpendicular downward position.
- If the length of the steady leg can be adjusted, remove the splint (Fig. 32,4) out of the support foot extension (Fig. 32,5).
- Pull out the support foot extension until it has reached the required length.
- Insert the splint in the support foot extension.
- Rotate the hexagonal nut until the steady leg rests completely on the ground and the vehicle is in a horizontal position.

- Retracting:*
- Place the socket spanner on the hexagon nut (Fig. 32,1) and rotate until the steady leg is clear of the ground.
 - If the length of the steady leg can be adjusted, remove the splint (Fig. 32,4) out of the support foot extension (Fig. 32,5).
 - Push in the support foot extension (Fig. 32,5) and insert the splint (Fig. 32,4) in the drilled hole in the support foot extension.
 - Rotate the hexagonal nut (Fig. 32,1) until the steady leg has swung upwards and the guide (Fig. 32,2) has reached the very end of the slot (Fig. 32,3).



- ▷ Before commencing the journey, observe the following: Are all steady legs and support foot extensions retracted completely and secured with the splint?

5.5.3 Steady legs (AL-KO) (partially special equipment)

In order to ensure their correct function, clean and grease the interior tubes of the steady legs regularly.

The length of the steady legs can be adjusted according to the model.

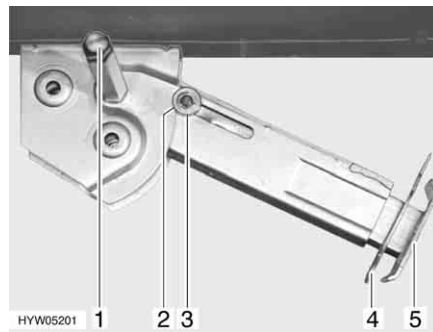

Fig. 33 Steady leg

- Extending:*
- Place the socket spanner on the hexagon nut (Fig. 33,1) and rotate until the steady leg is in a perpendicular downward position.
 - Remove the splint (Fig. 33,4) out of the support foot extension (Fig. 33,5).
 - Extend the support foot extension until it has reached the required length.
 - Insert the splint in the support foot extension.
 - Rotate the hexagonal nut until the steady leg rests completely on the ground and the vehicle is in a horizontal position.

- Retracting:*
- Place the socket spanner on the hexagon nut (Fig. 33,1) and rotate until the steady leg is clear of the ground.
 - Remove the splint (Fig. 33,4) out of the support foot extension (Fig. 33,5).
 - Push in the support foot extension (Fig. 33,5) and insert the splint (Fig. 33,4) in the drilled hole in the support foot extension.
 - Rotate the hexagonal nut (Fig. 33,1) with the socket spanner until the steady leg has swung upwards and the guide disc (Fig. 33,3) has completely retracted into the notch (Fig. 33,2).



- ▷ Before commencing the journey, observe the following: Are all steady legs and support foot extensions retracted completely and secured with the splint?

5.6 Electrical steady legs (AL-KO) (special equipment)



- ▶ Always observe the electrical steady legs when extending or retracting them.
- ▶ When extending or retracting the steady legs, ensure that no one is in the vehicle. Risk of injury due to unexpected rolling motion.



- ▷ Never extend the steady legs so far that the tyres of the vehicle are not in contact with the ground. This could damage the body and chassis and the brakes will not work.
- ▷ The steady legs are designed only to support the vehicle, not to level it.
- ▷ Steady legs need sufficient ground clearance to be able to fold out vertically.
- ▷ If the vehicle is equipped with pneumatic springs, follow the indications for extending and retracting. Otherwise, the motor of the steady legs can become overloaded.



- ▷ The electrical steady legs can only be operated with the ignition switched off.
- ▷ If the remote control is not operated for two minutes after the controller has been activated, the controller automatically switches off.
- ▷ When a key on the remote control is pressed, the indicator lamp flashes.
- ▷ If the steady legs are extended and the ignition is switched on, a pulsating warning tone is heard. The warning tone stops after the ignition has been switched off.



Fig. 34 Remote control for electrical steady legs

Button functions

- Preselection: steady leg left (Fig. 34,4)
- Preselection: steady leg right (Fig. 34,2)
- Retract steady leg (Fig. 34,1)
- Extend steady leg (Fig. 34,3)
- Control LED (Fig. 34,5)

Each time a button is pressed, the control LED (Fig. 34,5) flashes.



Fig. 35 Push-button to activate remote control

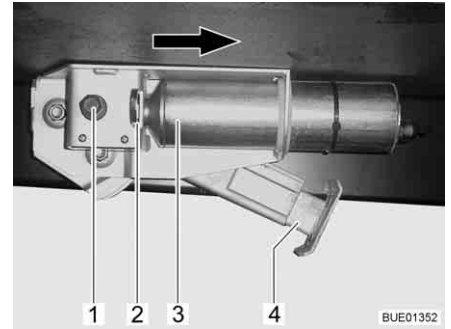

Fig. 36 Electrical steady leg on vehicle



- ▷ Do not extend the steady leg to the end position without it being in contact with the ground.

Extending:

- If the vehicle is equipped with pneumatic springs: First lower the pneumatic spring (see section 4.5.2 and 4.5.3), then extend the steady legs.
- Press the push button (Fig. 35,1) for approx. 2 seconds until a brief sound is emitted. The steady legs control is now activated.
- Press and hold the preselection button for the steady leg side (Fig. 34,2 or 4) for approx. 1 second.
- Within 2 seconds, press the "Extend steady leg" button (Fig. 34,3) and hold it until the support leg (Fig. 36,4) is touching the ground.
- Press the preselection button for the other steady leg side and repeat the procedure.

Retracting:

- If the vehicle is equipped with pneumatic springs: First raise the pressure in the pneumatic spring (see the manufacturer's instruction manual), then retract the steady legs.
- Press the push button (Fig. 35,1) for approx. 2 seconds until a brief sound is emitted. The steady legs control is now activated.
- Press and hold the preselection button for the steady leg side (Fig. 34,2 or 4) for approx. 1 second.
- Within 2 seconds, press the "Retract steady leg" button (Fig. 34,1) and hold it until the support leg (Fig. 36,4) is fully retracted. Once the support leg is fully retracted, a control signal sounds.
- Press the preselection button for the other steady leg side and repeat the procedure.

Changing the remote control battery:

- Remove the rear casing.
- Change the battery (CR2032). Observe the correct polarity ("+" to the outside).



- ▷ The battery must be changed if the control LED flashes more slowly or if it goes out.

Emergency operation If the electric drive breaks down, the steady legs can be moved with the hand crank.

Extending/retracting:

- Press the securing bracket (Fig. 36,2) inwards.
- Push the motor (Fig. 36,3) in the direction indicated as far as it will go.
- Extend or retract the steady leg like a mechanical steady leg via the hexagonal nut (Fig. 36,1).

When the fault has been rectified: Push the motor in the opposite direction of the arrow to its initial position. Pull out the securing bracket (Fig. 36,2) until it engages.



- ▷ Further information can be obtained in the manufacturer's instruction manual.

5.7 230 V connection

The vehicle can be connected to a 230 V power supply (see chapter 8).

5.8 Refrigerator



- ▶ If the refrigerator is set to 12 V operation, it will constantly consume current. Therefore, switch over to gas operation when the vehicle engine is **not** running, and the vehicle is **not** connected to the 230 V power supply.

For units with an automatic power selection, the 12 V operation of the refrigerator only functions in the automatic mode when the vehicle engine is running. When the vehicle engine is switched off, switch the refrigerator to 230 V operation or gas operation.

5.9 Satellite unit (special equipment)



- ▶ Before commencing the journey, ensure that the antenna is in park position. Danger of accidents!



- ▷ The vehicle must be still during the satellite search. Do not walk through the vehicle.
- ▷ Satellite reception is only possible, when the antenna is positioned in direct line of sight of the chosen satellite and the view is not blocked in any way.
- ▷ Further information can be obtained in the device manufacturer's instruction manual.

5.9.1 Equipment with automatic antenna alignment (Alden)

The satellite unit is equipped with an automatic positioning unit. This automatic positioning unit ensures that the antennas are aligned accurately.

The flat screen incorporates a digital receiver.

The satellite unit is operated via remote control.

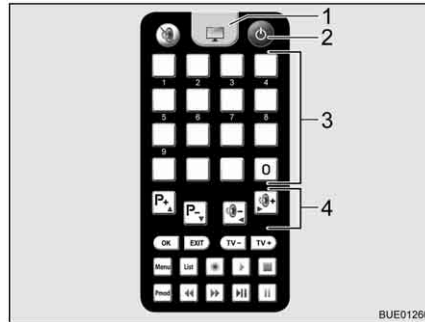

- 1 TV button
- 2 On/Off key
- 3 Memory buttons
- 4 Function buttons

Fig. 37 Remote control

Setting up the unit:

- Switch on the television and receiver.
- Press the key "⏻" (Fig. 37,2) on the remote control. The satellite antenna lifts out of the park position and moves to the last used position. As soon as the unit finds the satellite, you will hear two signal tones.
- Use the memory buttons (Fig. 37,3) or the function buttons (Fig. 37,4) to set the required transmitter.

5.9.2 Equipment with automatic antenna alignment (Oyster)



- ▶ Before commencing the journey, ensure that the antenna is in park position. Danger of accidents!



- ▷ The vehicle must be still during the satellite search. Do not walk through the vehicle.
- ▷ Satellite reception is only possible, when the antenna is positioned in direct line of sight of the chosen satellite and the view is not blocked in any way.
- ▷ Also read the manufacturer's instruction manual.

The satellite unit is equipped with an automatic positioning unit. This automatic positioning unit ensures that the antennas are precisely aligned to the desired satellites.

Operation is menu-controlled (TV screen) using the remote control.

Setting up the unit:

- Switch on the television.
- Use the mains switch to switch on the receiver. When the green LED on the receiver's infra-red receptor lights up, the receiver is ready to operate.
- Switch on the receiver with the remote control. The satellite antenna repositions itself out of the park position and into search mode.

When the system finds the satellite, the selected TV programme appears automatically.

Satellite mouse

Depending on the model, the satellite receiver is equipped with a satellite mouse. The satellite mouse's display (Fig. 38,2) shows the current channel. The two buttons can be used to operate the basic functions of the satellite unit (changing channel, switching on/off).

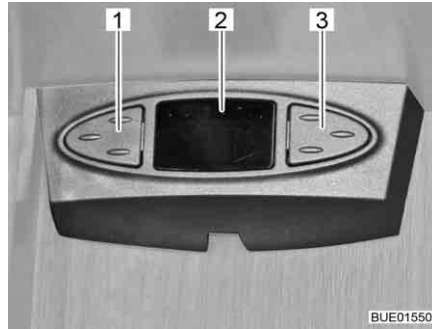

Fig. 38 Satellite mouse

Operating the satellite mouse:

- Choosing the previous channel from the list: Press left button (Fig. 38,1).
- Choosing the next channel from the list: Press right button (Fig. 38,3).
- Switching between radio and TV: Press the buttons (Fig. 38,1 and Fig. 38,3) briefly at the same time.
- Switching the receiver on/off: Press and hold the buttons (Fig. 38,1 and Fig. 38,3) at the same time.

5.10 Awning (special equipment)



- ▷ Retract the awning in strong wind, rain or snow.
- ▷ In the case of light rain, shorten one of the support legs so that water can run off.
- ▷ Only retract the awning when the fabric is dry. When the awning must be retracted while the fabric is still wet: Extend the awning as soon as possible, in order to dry out the fabric.
- ▷ Before retracting, remove leaves and coarse dirt from the awning.



- ▷ Only use the awning for protection against the sun.
- ▷ Also read the manufacturer's instruction manual.

Advantages of the awning

The advantages of an awning are:

- The awning provides shade.
- The awning creates a covered vestibule and thus expands the space.
- The vehicle thus becomes more homelike.



Fig. 39 Awning

Putting up the awning:

- Use the manual crank to open up the awning (Fig. 39,1).
- Set up the brackets (Fig. 39,2) when the awning is open.

Chapter overview

This chapter contains instructions about living in the vehicle.

The instructions address the following topics:

- opening and closing the doors and flaps
- light switches
- adjusting the spotlights
- light control
- positioning the television
- ventilation of the vehicle
- opening and closing the windows and blinds
- opening and closing the Roman shades in the driver's cabin
- opening and closing the skylights
- modifying the table surfaces
- converting tables
- the adjustment mechanism of the divan
- use of the beds
- use of the external shower

6.1 Central locking system (special equipment)



- ▷ The central locking mechanism locks the driver's door, the passenger's door and the conversion entrance door.
- ▷ The central locking system has no function, if the battery cut-off switch on the transformer/rectifier is switched off.
- ▷ If, after you press the release button, a door is not opened within 40 seconds, the central locking system automatically locks the doors again.



Fig. 40 Remote control for central locking system

Unlocking: ■ Press the  button (Fig. 40,1) once briefly. The door locks are unlatched.

Locking: ■ Press the  button (Fig. 40,2) once briefly. The door locks are locked.

6.2 Conversion door



- ▶ Only drive with locked doors.



- ▷ Locking the doors can prevent them from opening of their own accord, e.g. during an accident.
- ▷ Locked doors also prevent forced entry, e.g. when waiting at traffic lights. However, in an emergency, locked doors make it more difficult for helpers to enter the vehicle.
- ▷ When leaving the vehicle, always lock the doors.

6.2.1 Conversion door, outside (Hartal M1)

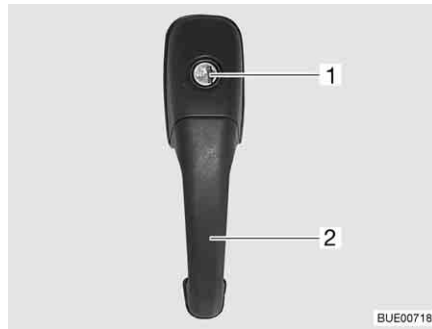

Fig. 41 Door lock of conversion door, outside

- Opening:**
- Insert the key into locking cylinder (Fig. 41,1) and turn until the door lock is unlatched.
 - Return the key to the central position and remove it.
 - Pull on the handle (Fig. 41,2). The door is open.
- Locking:**
- Insert the key into locking cylinder (Fig. 41,1) and turn until the door lock is engaged.
 - Return the key to the central position and remove it.

6.2.2 Conversion door, inside (Hartal M1)



Fig. 42 Door lock of conversion door, inside, locked

- Opening:**
- Press lever (Fig. 42,2).
- Locking:**
- Push the sliding trap (Fig. 42,1) down.

6.2.3 Conversion door, outside (Hartal Premium) (partially special equipment)

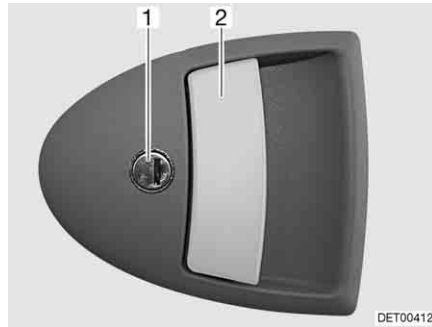

Fig. 43 Door lock of conversion door, outside

- Opening:**
- Insert the key into locking cylinder (Fig. 43,1) and turn until the door lock is unlatched.
 - Return the key to the central position and remove it.
 - Pull on the handle (Fig. 43,2). The door is open.
- Locking:**
- Insert the key into locking cylinder (Fig. 43,1) and turn until the door lock is engaged.
 - Return the key to the central position and remove it.

6.2.4 Conversion door, inside (Hartal Premium) (partially special equipment)

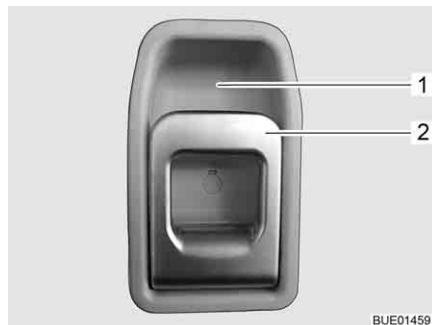

Fig. 44 Door lock of conversion door, inside

- Opening:**
- Pull on the handle (Fig. 44,2). The door lock is unlatched.
- Locking:**
- Press the upper part of the handle (Fig. 44,2) in the direction of the recessed handle (Fig. 44,1).

6.2.5 Window of conversion door (Hartal Premium) (partially special equipment)

The conversion door window is fitted with a Roman shade.

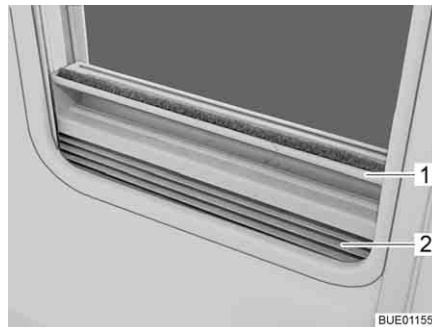

Fig. 45 Roman shade

- Closing:*
- Grip the Roman shade (Fig. 45,2) in the middle of the holding bar (Fig. 45,1), pull it upwards and then release it at the desired height. The Roman shade will stay at this height.
- Opening:*
- Grip the Roman shade in the middle of the holding bar and push it down.

6.2.6 Folding insect screen on the conversion door (partially special equipment)



- ▷ Open the insect screen completely before closing the conversion door.



Fig. 46 Insect screen

- Closing:*
- Pull out the insect screen completely by the bar (Fig. 46,1).
- Opening:*
- Push the insect screen into its initial position by the bar (Fig. 46,1).

6.3 External flaps



- ▷ Before commencing the journey, close all external flaps and lock them.
- ▷ To open and close the external flap, open or close all locks that are fitted to the external flap.



- ▷ When leaving the vehicle, close all external flaps.

The external flaps fitted to the vehicle are all fitted with identical locking cylinders. Therefore, all locks can be opened with a single key.

6.3.1 Flap lock with recessed handle



- ▷ To open the external flap, pull all the lock handles fitted to that particular external flap at the same time.

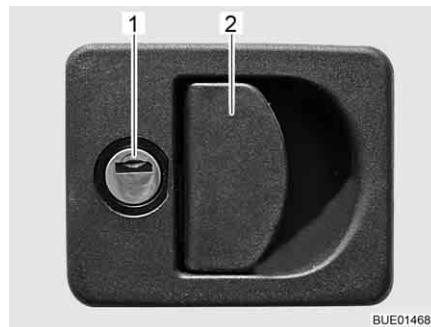

- 1 Locking cylinder
- 2 Lock handle

Fig. 47 Flap lock with recessed handle

- Opening:**
- Insert key into locking cylinder (Fig. 47,1) and turn a quarter turn. The flap lock is unlatched.
 - Remove the key.
 - Pull on the lock handle (Fig. 47,2). The external flap is open.

- Closing:**
- Firmly close the external flap.
 - Insert key into locking cylinder and turn a quarter turn. The flap lock is locked.
 - Remove the key.

6.3.2 Flap lock, square

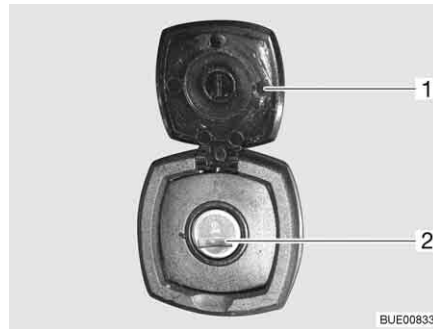

- 1 Cap
- 2 Locking cylinder

Fig. 48 Flap lock, square

- Opening:*
- Open the cap (Fig. 48,1).
 - Insert key into locking cylinder (Fig. 48,2) and turn a quarter turn.
 - Remove the key.

- Closing:*
- Firmly close the external flap.
 - Insert key into locking cylinder.
 - Turn key one quarter turn.
 - Remove the key.

6.3.3 Flap lock with push button

Depending on the flap size the service flap is equipped with one or two lockable push-button locks.

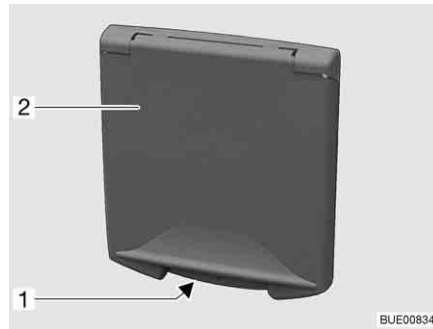

Fig. 49 Push-button lock service flap

- Opening:*
- Insert the key into locking cylinder of the lockable push-button lock (Fig. 49,1) and turn a quarter turn. The push-button lock is unlatched.
 - Remove the key.
 - If equipped, unlock the second lockable push-button lock as well.
 - Press the two push buttons of the push-button locks simultaneously with the thumb and open the service flap.

- Closing:*
- Close the service flap and press it shut. The push-button locks are now engaged but not locked.
 - Insert the key into locking cylinder of the lockable push-button lock (Fig. 49,1) and turn a quarter turn. The push-button lock is locked.
 - Remove the key.
 - If equipped, lock the second lockable push-button lock as well.

6.3.4 Flap for the 230 V connection, square



- 1 Recessed grip
- 2 External flap

Fig. 50 Flap for the 230 V connection

- Opening:*
- Reach into the recessed grip (Fig. 50,1) on the external flap (Fig. 50,2) and swing the external flap upward.
- Closing:*
- Swivel the external flap downwards and press it shut.

6.3.5 Cap for the drinking water filler neck

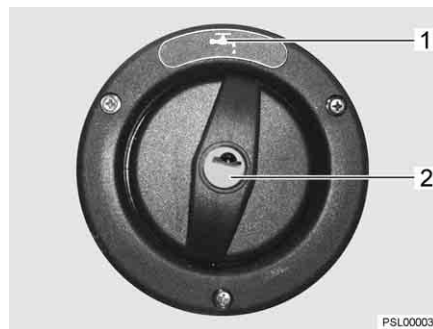

Fig. 51 Cap for the drinking water filler neck



- ▷ The drinking water filler neck is indicated by the symbol "☕" (Fig. 51,1).

- Opening:*
- Insert the key in the locking cylinder (Fig. 51,2) and turn it in an anticlockwise direction.
 - Remove cap.
- Closing:*
- Insert the cap in the drinking water filler neck.
 - Turn key in a clockwise direction.
 - Remove the key.

6.4 Furniture flaps and inner doors



- ▷ Before commencing the journey, close all furniture flaps and inner doors and lock them.
- ▷ The furniture flaps shown in this section are examples. Depending on the model, the locks and handles on the furniture flaps may differ to those displayed here.

6.4.1 Furniture flaps with push button



Fig. 52 Furniture flap with push button

- Opening:*
- Press inner part of the lock. The push button jumps out (Fig. 52).
 - Hold push button and open furniture flap.
- Closing:*
- Press furniture flap shut.
 - Press push button in until it locks. The furniture flap is closed correctly when the fastener locks into place.

6.4.2 Furniture flaps with release handle

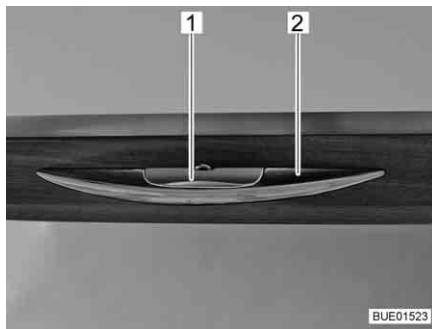

Fig. 53 Furniture flap with release handle

- Opening:*
- Press the release handle (Fig. 53,1) and hold it down.
 - Pull the handle (Fig. 53,2) until the furniture flap is open.
- Closing:*
- Press the furniture flap down until you can feel the flap hinge close and hear the lock snap into place.

6.4.3 Floor compartment cover

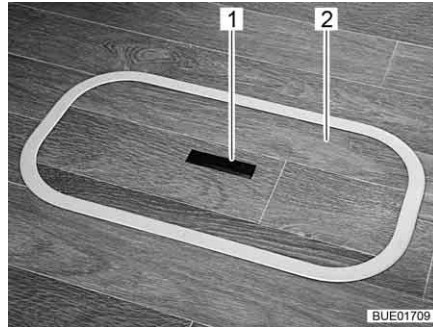

Fig. 54 Floor compartment cover (handle recessed)

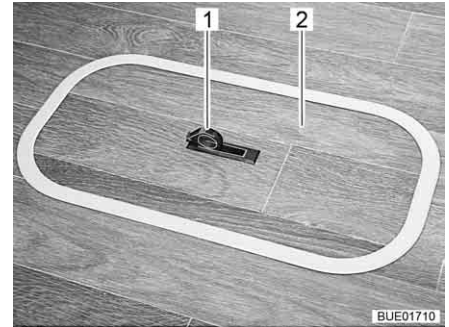

Fig. 55 Floor compartment cover (handle swung out)

- Opening:*
- Push one side of the grip plate (Fig. 54,1) downwards. The handle (Fig. 55,1) swivels upwards.
 - Remove the cover (Fig. 54,2 or Fig. 55,2) upwards.

- Closing:*
- Insert the cover in the frame on the floor.
 - Swivel handle downwards.

6.4.4 Driver's cabin partition (only Argos 747-2)



- ▷ Drive only with the driver's cabin partition secured.

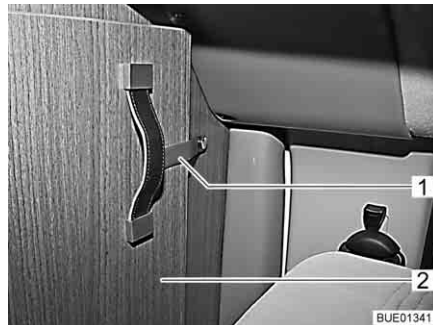

Fig. 56 Securing strap

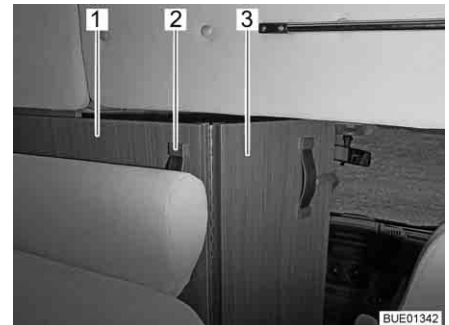

Fig. 57 Driver's cabin partition

- Closing:*
- Release the securing strap (Fig. 56,1) from the foldable section of the driver's cabin partition (Fig. 56,2).
 - Grip the handle (Fig. 57,2) of the driver's cabin partition (Fig. 57,1) and pull it inwards until the edge of the driver's cabin partition is roughly level with the backrest of the bench seat (Fig. 57).
 - Fold out the folding part of the driver's cabin partition (Fig. 57,3) between the seats of the driver's cabin.

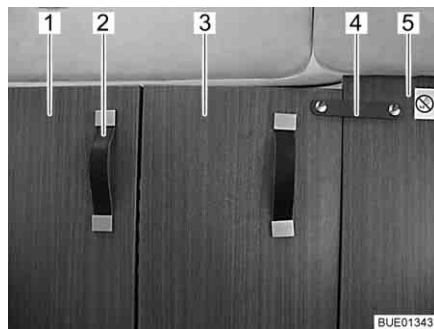

Fig. 58 Driver's cabin partition, closed

- Pull the driver's cabin partition (Fig. 58,1) completely inwards using the handle (Fig. 58,2).
- Using the securing strap (Fig. 58,4), secure the folding section of the driver's cabin partition (Fig. 58,3) to the fixed partition wall (Fig. 58,5) behind the front passenger seat.

Opening: ■ Open and secure the driver's cabin partition in the reverse order of the closing process.

6.5 Light switch

6.5.1 Entrance area



- ▷ The light switches shown in this section are examples. Depending on the model, the type and allocation of the light switches may differ to those displayed here.

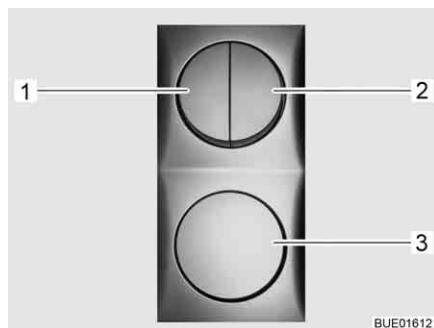

Fig. 59 Light switch



Fig. 60 Awning light

The entrance area has light switches (Fig. 59,1-3) for the following lamps:

- Entrance lights
- Awning lights
- Living area lights

6.5.2 Interior



- ▷ The lamps shown in this section are examples. Not all lamps used in the vehicle are shown. The examples are intended to clarify the possible positions for the light switches. The type and appearance of the light switches can deviate from those shown here.
- ▷ Depending on the equipment, there may also be the option of switching lights on and off in groups with separate light switches.

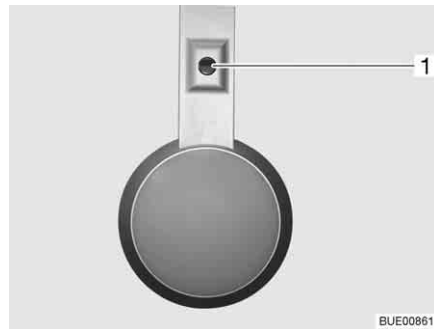

Fig. 61 Lamp, switch mounted directly on the lamp



Fig. 62 Halogen spotlight, light switch directly on the lamp

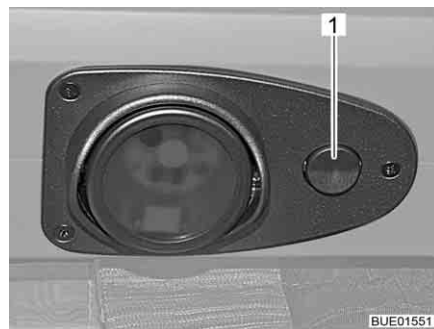

Fig. 63 Recessed LED light

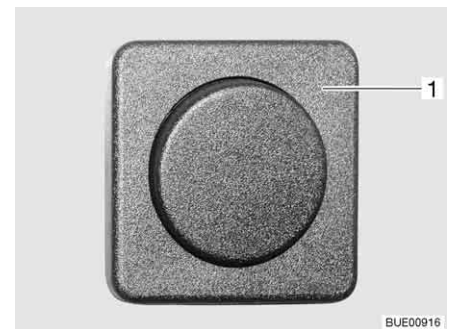

Fig. 64 Switch, separate from the lamp (example)

The light switches in the interior are located either on the lamp itself (Fig. 61, 1, Fig. 62, 1, Fig. 63, 1) or near the lamp (Fig. 64, 1).

6.5.3 Wardrobe light (partially special equipment)



- ▷ The wardrobe light can be removed from its holder (Fig. 65, 1) and used as a torch.
- ▷ When the wardrobe door is closed, the wardrobe light switches off automatically.
- ▷ A brightness sensor ensures that the wardrobe light comes on only when it is dark. This prevents the wardrobe light from being accidentally switched on during daylight hours, which would waste the batteries.

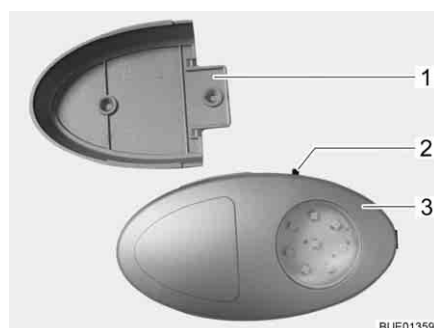

Fig. 65 Wardrobe light

The On/Off switch (Fig. 65, 2) is located directly on the wardrobe light (Fig. 65, 3).

6.6 Spotlight



- ▶ Bulbs and light fittings can be extremely hot.
- ▶ Allow the light bulbs and lamp holders to cool down before touching them.
- ▶ If the light is switched on or still hot, there must always be a safety distance of at least 30 cm between stores or curtains and flammable objects. Fire hazard!

The spotlight can be rotated, moved or detached.

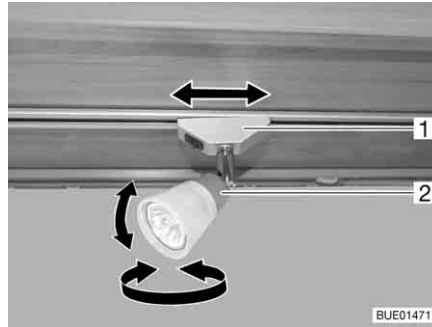

Fig. 66 Spotlight

Rotating: ■ Grasp the housing (Fig. 66,2) and turn it.

The housing can be turned in different directions:

- To the left and to the right
- Up and down

Shifting: ■ Grip holder (Fig. 66,1) and turn by approx. 45°.
■ Push spotlight along the rail system to desired position.

Removal: ■ Grip holder (Fig. 66,1) and turn by approx. 90°.
■ Remove spotlight from rail.

The spotlight can be installed in any position into the rails.

6.7 Light control (only Argos 747-2)

Functions Depending on the model, the vehicle is fitted with a central lighting system. This lighting system operates and dims single lamps or lamp groups that form part of the lighting system.

Furthermore, scene functions are integrated into the lighting system. These scene functions enable the user to save and automatically recall the desired brightness of all lamp groups.



- ▷ The lights that are not integrated into the lighting system (e.g. kitchen light, bathroom light or reading spotlights) are switched on and off via separate light switches.

Light switch

The lights that are integrated into the lighting system are controlled via buttons on the panel (Fig. 67) or via buttons on two switches (Fig. 68 and Fig. 69). The switches are installed at various points in the vehicle.

Buttons on the panel All light control functions are available on the panel.



Fig. 67 Panel

Buttons on the switch Not all light control functions are available on the two switches.



Fig. 68 Buttons in the living area



Fig. 69 Buttons in the living or sleeping area

Symbols The symbols listed in the following table always have the same meaning.

Symbol	Signification
M	Light scene
	Main light, living area
	Indirect lighting, living area
	Main light, sleeping area
	Indirect lighting, sleeping area
	Night light
	All lights "OFF"

Operation Each button has different functions:

Button	Press shortly	Keep pressed
Scene	Switch the preset scene on/off	Save the current scene setting (> 3 seconds, until all lamps which are switched on flicker briefly)
Light	Switch the appropriate lamp on/off	Dim the appropriate lamp (> 1 second)

6.8 Holder for flat screen



- ▶ Before commencing the journey, place and secure the flat screen and screen support in the initial position. If the screen holder is installed in a TV cabinet: Close TV cabinet.

6.8.1 Holder on the column

The holder for the flat screen is attached to a column.

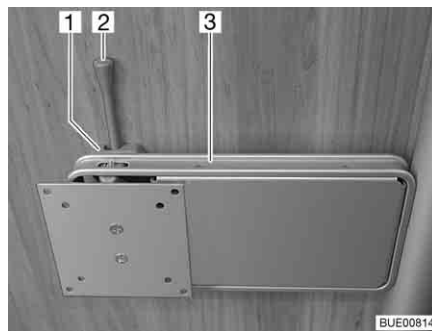

Fig. 70 Holder on the column

- Positioning:*
- Push the release lever (Fig. 70,2) to the side and turn the holder (Fig. 70,3) with the flat screen to the desired position.
 - Press flat screen slightly upward and swivel it to the desired position. Three different inclination angles may be used.

- Storing away:*
- Turn flat screen back until the holder (Fig. 70,3) engages in the lock (Fig. 70,1).

6.8.2 Holder with jointed arm

The flat screen is fastened to a jointed arm.

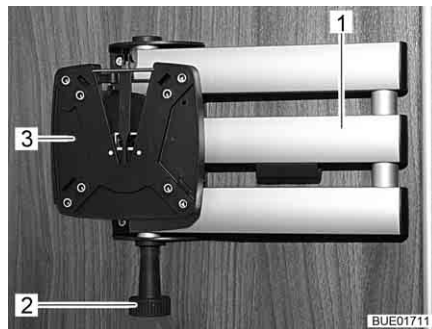

Fig. 71 Holder with jointed arm

Positioning:

- Pull the release knob (Fig. 71,2). The jointed arm (Fig. 71,1) is unlocked.
- Swivel flat screen into the desired position.
- Take hold of the flat screen at the top and bottom edge with both hands and set the desired angle of inclination.

Storing away:

- Turn the flat screen back into the original position until you hear the holder (Fig. 71,3) engage in the lock.

6.8.3 Holder in the TV cabinet

The flat screen is attached to a console in the TV cabinet.



Fig. 72 Holder in the TV cabinet

Positioning:

- Push the unlocking bar (Fig. 72,1) in.
- Pull out the extension (Fig. 72,2) as far as possible.
- Swivel flat screen into the desired position.

Storing away:

- Swing back flat screen into its original position.
- Push in the extension (Fig. 72,2) until the unlocking bar (Fig. 72,1) engages.

6.9 Ventilation



- ▶ The oxygen in the vehicle interior is used up by breathing and the use of gas operated appliances. That is why the oxygen needs to be replaced on a constant basis. For this purpose, forced ventilation options (e.g. skylights with forced ventilation, mushroom-shaped vents or floor vents) are fitted to the vehicle. Never cover or block forced ventilations from the inside or outside with objects such as e.g. a winter mat. Keep forced ventilations clear of snow and leaves. There is a danger of suffocation due to increased CO₂ levels.



- ▷ Although sufficient ventilation is provided, in certain weather conditions, condensation can form on metal objects (e.g. screwed connections in the floor).
- ▷ Additional cold spots can occur at thermal "bridges" (e.g. mushroom-shaped vents, skylight edges, sockets, filler necks, flaps, etc.).

Condensation

Ensure that there is a continuous exchange of air by providing frequent and efficient ventilation. This is the only method for ensuring that condensation and resulting mould is not formed during cool weather. During the colder season, a pleasant living climate is created if heating output, air distribution and ventilation are synchronised. To avoid draft close the air outlet nozzles on the dashboard and set the air distribution of the base vehicle to air circulation.

If the vehicle is laid up for a longer period, occasionally ventilate it well, especially in summer as heat accumulation can occur. Do not only air the interior, but also the storage compartments which are accessible from the outside. Air the parking place as well if the vehicle is parked in a closed space (e.g. garage). The occurrence of condensation could lead to the formation of mould.

6.10 Windows



- ▷ The windows are fitted with a blind or Roman shade and with an insect screen or folding insect screen. After the latch has been released, the blind and insect screen automatically spring back to the initial position by tensile force. In order not to damage the tension mechanics, hold onto the blind or insect screen and allow it to slowly return to the initial position. The Roman shade and folding insect screen are made of thin woven fabric. In order not to damage the Roman shade or the insect screen, grasp the respective handle and carefully return it to the initial position.
- ▷ Do not keep blinds closed over a longer period of time as that can cause increased material wear.
- ▷ If the blind or the Roman shade is completely closed, exposure to direct sunlight can cause heat to accumulate between the blind/the Roman shade and the window. The window could be damaged.
Therefore, if the shade is installed in the bottom blind box, close the shade only 2/3 when sunlight is intense. This allows the heat to escape between the window and the shade.
If the shade is installed in the top blind box, close the shade fully and open it regularly.
Also move the window into the "continuous ventilation" position.
- ▷ Before commencing the journey, close the windows.



- ▷ Depending on the weather, close the windows far enough to prevent moisture from entering.
- ▷ To open and close the window, open or close all catch levers which are fitted to the window.



- ▷ When leaving the vehicle, always close the windows.
- ▷ In extreme weather conditions or if the temperature fluctuates strongly, a light condensation film can form on the double-glazed acrylic glass. The glass is designed in such a way that condensation can evaporate when the external temperature increases. There is no danger of the double-glazed acrylic glass being damaged by condensation.

6.10.1 Hinged window with rotary hinges



- ▷ When opening the hinged windows, ensure that there are no torsional forces. Open and close the hinged windows evenly.
- ▷ If the catch lever is equipped with a safety knob, press the safety knob when operating the catch lever.

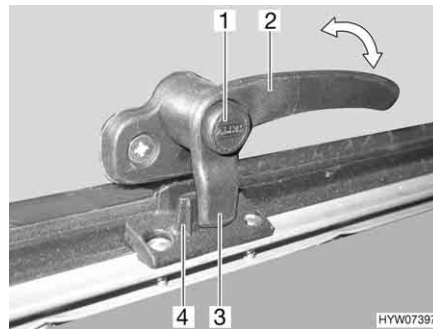

Fig. 73 Catch lever with safety knob in "closed" position

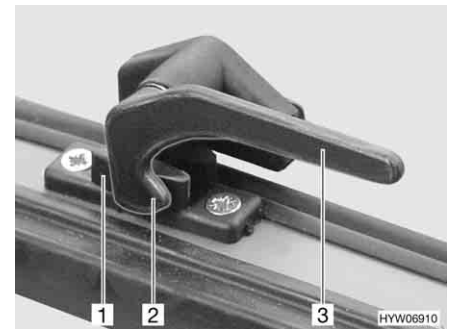

Fig. 74 Catch lever in "closed" position

Opening:

- Press and hold the security button (Fig. 73,1), if present.
- Turn the catch lever (Fig. 73,2 or Fig. 74,3) a quarter turn towards the centre of the window.

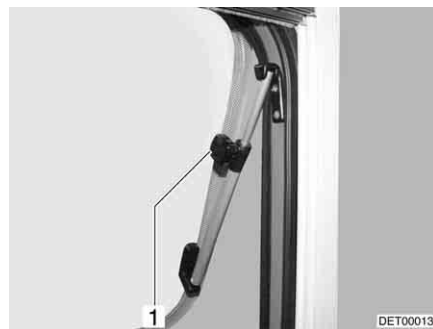

Fig. 75 Hinged window with rotary hinges

- Open the hinged window until the required position has been reached and use knurled knob (Fig. 75,1) to secure in position.

The hinged window remains locked in the required position.

Closing:

- Turn knurled knob (Fig. 75,1) until the latch is released.
- Close the hinged window.

- Press and hold the security button (Fig. 73,1), if present.
- Turn the catch lever (Fig. 73,2 or Fig. 74,3) a quarter turn towards the window frame. The locking catch (Fig. 73,3 or Fig. 74,2) on the catch lever is entirely on the inner side of the window catch (Fig. 73,4 or Fig. 74,1).

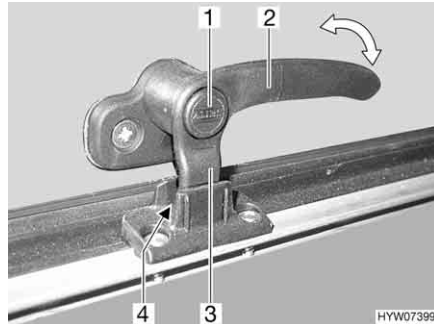

Fig. 76 Catch lever with safety knob in "continuous ventilation" position

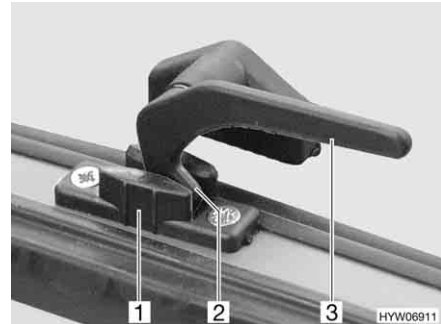

Fig. 77 Catch lever in "continuous ventilation" position

Continuous ventilation

With the catch lever, the hinged window can be placed in two positions:

- "Continuous ventilation" (Fig. 76 and Fig. 77)
- "Firmly closed" (Fig. 73 and Fig. 74)

To place the hinged window into the "continuous ventilation" position:

- Press and hold the security button (Fig. 76,1), if present.
- Turn the catch lever (Fig. 76,2 or Fig. 77,3) a quarter turn towards the centre of the window.
- Slightly open the hinged window outwards.
- Return the catch lever to its initial position. Move the locking catch (Fig. 76,3 or Fig. 77,2) on the catch lever into the recess of the window catch (Fig. 76,4 or Fig. 77,1).
- Press and hold the security button (Fig. 76,1), if present.
- Make certain that the safety knob is not pushed in but rather that it secures the catch lever.

During the journey, the hinged window may not be in "continuous ventilation" position.

If it rains, the "continuous ventilation" hinged window position could lead to splashing water penetrating the living area. Therefore, close the hinged windows completely.

6.10.2 Hinged window with automatic hinges



- ▷ Open the window completely, to release the lock. If the locking device is not released and the window is closed nevertheless, there is the danger of the window breaking due to the massive counter-pressure.
- ▷ When opening the hinged windows, ensure that there are no torsional forces. Open and close the hinged windows evenly.
- ▷ If the catch lever is equipped with a safety knob, press the safety knob when operating the catch lever.

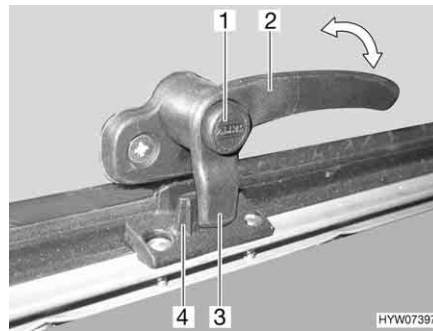

Fig. 78 Catch lever with safety knob in "closed" position

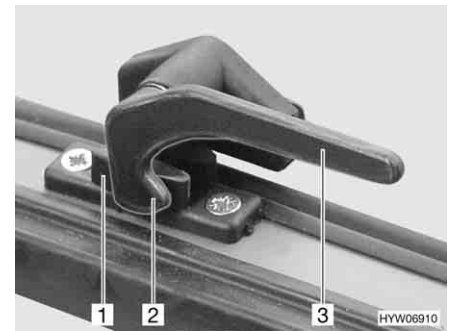

Fig. 79 Catch lever in "closed" position

Opening:

- Press and hold the security button (Fig. 78,1), if present.
- Turn the catch lever (Fig. 78,2 or Fig. 79,3) a quarter turn towards the centre of the window.



Fig. 80 Hinged window with automatic hinges

- Open the hinged window to the desired latched position. The automatic hinge (Fig. 80,1) locks in place automatically.

The hinged window remains locked in the required position.

Closing:

- Open the hinged window as wide as is necessary to release the lock.
- Close the hinged window.
- Press and hold the security button (Fig. 78,1), if present.
- Turn the catch lever (Fig. 78,2 or Fig. 79,3) a quarter turn towards the window frame. The locking catch (Fig. 78,3 or Fig. 79,2) on the catch lever is entirely on the inner side of the window catch (Fig. 78,4 or Fig. 79,1).

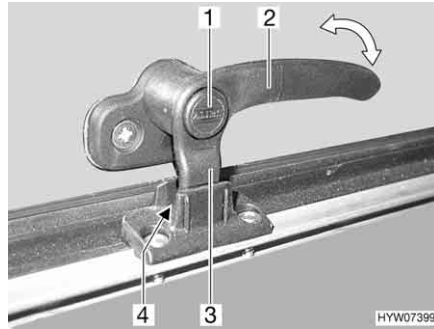

Fig. 81 Catch lever with safety knob in "continuous ventilation" position

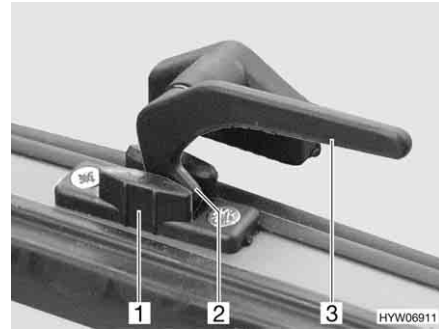

Fig. 82 Catch lever in "continuous ventilation" position

Continuous ventilation

With the catch lever, the hinged window can be placed in two positions:

- "Continuous ventilation" (Fig. 81 and Fig. 82)
- "Firmly closed" (Fig. 78 and Fig. 79)

To place the hinged window into the "continuous ventilation" position:

- Press and hold the security button (Fig. 81,1), if present.
- Turn the catch lever (Fig. 81,2 or Fig. 82,3) a quarter turn towards the centre of the window.
- Slightly open the hinged window outwards.
- Return the catch lever to its initial position. Move the locking catch (Fig. 81,3 or Fig. 82,2) on the catch lever into the recess of the window catch (Fig. 81,4 or Fig. 82,1).
- Press and hold the security button (Fig. 81,1), if present.
- Make certain that the safety knob is not pushed in but rather that it secures the catch lever.

During the journey, the hinged window may not be in "continuous ventilation" position.

If it rains, the "continuous ventilation" hinged window position could lead to splashing water penetrating the living area. Therefore, close the hinged windows completely.

6.10.3 Blind and insect screen



- ▷ Open blinds before commencing the journey. When the blinds are closed, vibrations can damage the spring shaft.

The windows are fitted with a blind and an insect screen. The blind and insect screen are adjusted separately.

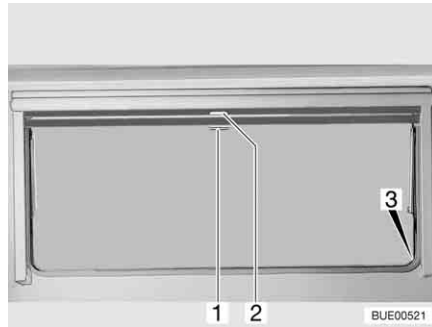

Fig. 83 Hinged window

Blind The blind is located in the upper blind box.

- Closing:*
- Pull blind at the handle (Fig. 83,2) downwards. If the blind is to be completely closed, it is suspended into the locking devices (Fig. 83,3) situated on both sides of the window frame.
- Opening:*
- If the blind is completely closed: Press handle (Fig. 83,2) downwards and, at the same time, tilt it slightly inward. The blind can be taken out of the locking devices situated on both sides of the window frame.
 - If the blind is in an intermediate position: Pull the handle (Fig. 83,2) slightly downwards until the locking device releases.
 - Use handle to return blind slowly to its initial position.

Insect screen The insect screen is located in the upper blind box.

- Closing:*
- Pull insect screen at the handle (Fig. 83,1) down and hang it into the locking devices (Fig. 83,3) situated on both sides of the window frame.
- Opening:*
- Press handle (Fig. 83,1) downwards and, at the same time, tilt it slightly inward. The insect screen can be taken out of the locking devices situated on both sides of the window frame.
 - Use handle to return the insect screen slowly to its initial position.

6.10.4 Roman shade and insect screen

The windows are fitted with a Roman shade and an insect screen. The insect screen can only be moved together with the Roman shade.

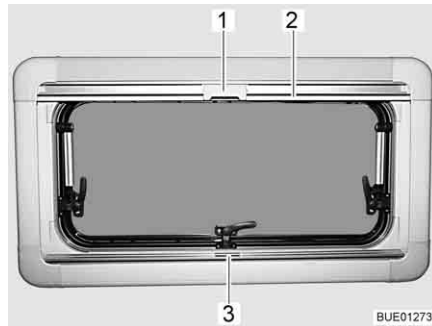

Fig. 84 Hinged window

Roman shade The Roman shade is located in the bottom blind box.

Closing: ■ Grip the Roman shade in the centre of the holding bar (Fig. 84,3), pull it from the bottom to the top and then release it at the desired height. The Roman shade will stay at this height.

Opening: ■ Grip the Roman shade in the centre of the holding bar and push it down.

Insect screen The insect screen is located in the upper blind box.

Closing: ■ Pull the insect screen down using the holding bar (Fig. 84,2), until it touches the holding bar of the Roman shade (Fig. 84,3).
 ■ Clip the catch (Fig. 84,1) on the insect screen into the handle of the Roman shade.

Opening: ■ Push the catch (Fig. 84,1) on the insect screen inwards.
 ■ Move the insect screen back slowly on the holding bar (Fig. 84,2).

6.10.5 Roman shades for windscreen, driver's window and front passenger's window

Depending on the model, the driver's cabin is shaded either with pleated shades or with Remis Roman shades (special equipment).

Pleated shades

The pleated shades are standard equipment on the vehicle.



Fig. 85 Pleated shades on passenger window



Fig. 86 Fixing of pleated shades

The pleated shades (Fig. 85,2) are fixed with snap fasteners (Fig. 85,1 and Fig. 86,1).

Remis Roman shades (special equipment)

The Roman shades are fixed with magnetic strips and are permanently fitted to the vehicle inside the frame.

Proceed as described below to open or close permanently installed Roman shades.

Windscreen



Fig. 87 Roman shade for the windscreen

Shading:

- Press the release handles (Fig. 87,1) and hold them down.
- Use the handle (Fig. 87,2) to pull the Roman shade for the windscreen towards the centre of the window.
- Close the second Roman shade for the windscreen in the same way. A magnetic catch holds both parts of the Roman shade together in the centre.

Opening the Roman shade:

- Press the release handles (Fig. 87,1) and hold them down.
- Use the handle (Fig. 87,2) to pull the two halves of the Roman shade for the windscreen outwards as far as they will go. As you do so, lift the handle up as high as the locking recess.
- Let go of the release handles (Fig. 87,1) and let them engage.

Driver's window and front passenger's window

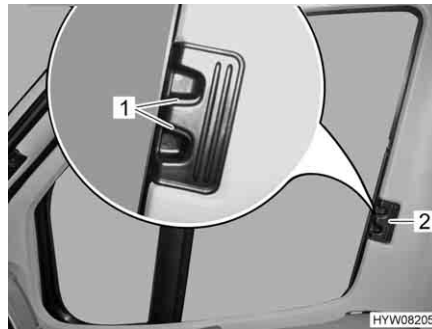

Fig. 88 Roman shade for driver's and passenger's window

- Shading:**
- Press the release handles (Fig. 88,1) and hold them down.
 - Using the handle (Fig. 88,2), draw the Roman shades for the driver's and passenger's window to the other side of the window and secure them to the magnetic strips.

- Opening the Roman shade:**
- Press the release handles (Fig. 88,1) and hold them down.
 - Use handle (Fig. 88,2) to push in the Roman shades for the driver's and passenger's window as far as possible.
 - Let go of the release handles (Fig. 88,1) and let them engage.

6.11 Skylights

Depending on the model, skylights with or without forced ventilation are fitted to the vehicle. If a skylight is fitted without forced ventilation, the forced ventilation is performed using mushroom-shaped vents.



- ▶ The apertures for forced ventilation must always be kept open. Never cover or block forced ventilations with objects such as e.g. a winter mat. Keep forced ventilations clear of snow and leaves.



- ▷ The skylights are fitted with a blind or Roman shade and with an insect screen or folding insect screen. After the latch has been released, the blind and insect screen automatically spring back to the initial position by tensile force. In order not to damage the tension mechanics, hold onto the blind or insect screen and allow it to slowly return to the initial position. The Roman shade and folding insect screen are made of thin woven fabric. In order not to damage the Roman shade or the insect screen, grasp the respective handle and carefully return it to the initial position.
- ▷ Do not keep blinds closed over a longer period of time as that can cause increased material wear.
- ▷ If the blind or the Roman shade is completely closed, exposure to direct sunlight can cause heat to accumulate between the blind/the Roman shade and the skylight. The skylight could be damaged. For that reason, close the blind/Roman shade only 2/3 of the way in direct sunlight. Open the skylight slightly or move it to ventilation position.
- ▷ Depending on the weather, close the skylights far enough to prevent moisture from entering.
- ▷ Do not climb on the skylights.



- ▷ Before commencing the journey, close the skylights.
- ▷ Before commencing the journey, check that the skylights are closed and locked.



- ▷ When leaving the vehicle, always close the skylights.

6.11.1 Heki skylight (mini and midi) (partially special equipment)

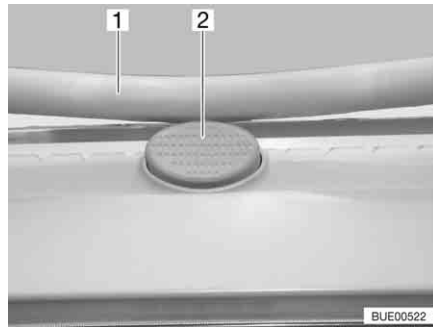

Fig. 89 Safety knob on the Heki skylight

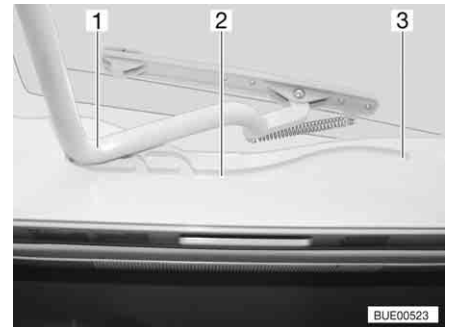

Fig. 90 Heki skylight, guide

The Heki skylight is opened on one side only.

Opening:

- Press the safety knob (Fig. 89,2) and pull the bar (Fig. 89,1) down with both hands.
- Pull the bar (Fig. 90,1) in the guides (Fig. 90,2) to the rearmost position (Fig. 90,3).

Closing:

- Use both hands to push the bar (Fig. 90,1) slightly upwards.
- Push the bar back in the guides.
- Push the bar upwards with both hands until it is above the safety knob (Fig. 89,2).

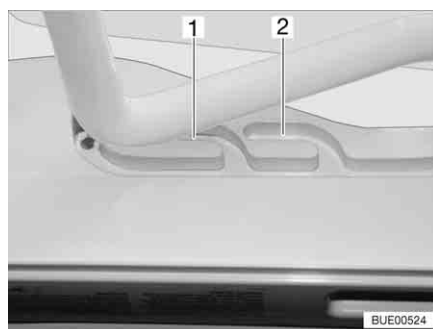

Fig. 91 Heki skylight in ventilation position

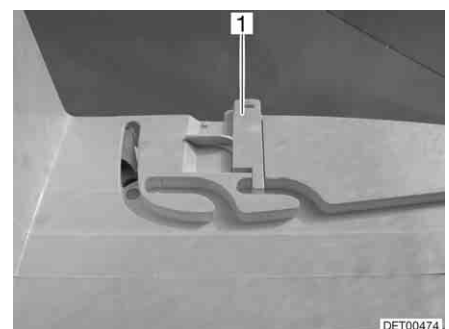

Fig. 92 Ventilation position locking mechanism

Ventilation position

The Heki skylight can be put in two ventilation positions: Bad weather position (Fig. 91,1) and central position (Fig. 91,2). Depending on the model, the skylight can be locked in the central position with both left and right latches (Fig. 92,1) on the skylight frame.

- Press the safety knob (Fig. 89,2) and pull the bar (Fig. 89,1) down with both hands.
- Pull the bar in the guides (Fig. 90,2) to the desired position.
- Push the bar slightly upwards and into the selected guide (Fig. 91,1 or 2) and lock if necessary.

Roman shade To close and open the Roman shade:

Closing: ■ Pull out Roman shade at the handle and release in the required position. The Roman shade will stay in that position.

Opening: ■ Slowly push the Roman shade at the handle to its initial position.

Insect screen To close and open the insect screen:

Closing: ■ Pull the insect screen by the handle to the opposite handle of the Roman shade.

Opening: ■ Press the rear part of the handle of the insect screen. The latch is released.
 ■ Use handle to return the insect screen slowly to its initial position.

6.11.2 Wind-up skylight (partially special equipment)

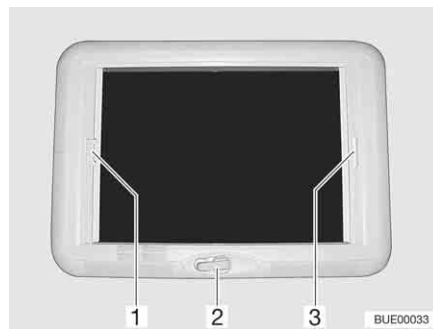

Fig. 93 Wind-up skylight

The wind-up skylight can be opened using the manual crank.

Opening: ■ Rotate the hand crank (Fig. 93,2) until a resistance can be felt.

Closing: ■ Rotate the hand crank until the wind-up skylight is closed. The wind-up skylight can be locked after rotating two or three more times.
 ■ Check the locking mechanism. To do so, press your hand against the acrylic glass.

Roman shade The Roman shade can be closed in any position, as desired. If the Roman shade is locked with the insect screen, the insect screen is also moved along on closing the Roman shade.

Closing: ■ Pull the handle of the Roman shade (Fig. 93,3) and release in the desired position. The Roman shade will stay in that position.

Opening: ■ Slowly push the Roman shade at the handle to its initial position.

Insect screen If the insect screen is locked with the Roman shade, the Roman shade is also moved along on closing the insect screen.

- Closing:**
- Pull insect screen at the handle (Fig. 93,1) to the opposite handle of the Roman shade (Fig. 93,3) and allow to engage.
- Opening:**
- Press the handle of the insect screen (Fig. 93,1) at the back upwards and detach the insect screen from the Roman shade (Fig. 93,3).
 - Slowly push insect screen at the handle to its initial position.

6.11.3 Omni-Vent skylight with fan (special equipment)



- ▷ To save the battery, after one hour the fan automatically switches from level 6 down to level 1.

The skylight is equipped with an insect screen, blind and an adjustable fan for ventilation.

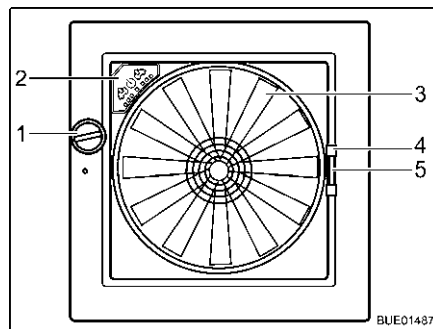

Fig. 94 Skylight Omni-Vent

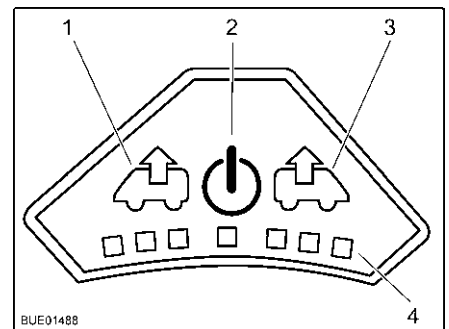

Fig. 95 Control panel for fan

- Opening:**
- Turn the knob (Fig. 94,1) until the desired opening angle is reached.
- Closing:**
- Turn the knob (Fig. 94,1) until the skylight is fully closed.

Insect screen To close and open the insect screen:

- Closing:**
- Using the handle (Fig. 94,4) pull the insect screen across to the other side of the frame.
- Opening:**
- Press the handle of the insect screen together. The latch is released.
 - Use handle to return the insect screen slowly to its initial position.

Shade To close and open the shade:

- Closing:**
- Press together the handle (Fig. 94,5) of the shade.
 - Pull out the shade to the desired position and release. The shade will stay in that position.
- Opening:**
- Press together the handle of the shade.
 - Slowly return the shade to its initial position.

Fan If the skylight is open, the interior can be ventilated with the 6-speed fan (Fig. 94,3). The fan is operated via the operating panel (Fig. 94,2).

- Switching on:**
- Press the On/Off button (Fig. 95,2). The fan runs in comfort mode (venting at slowest fan speed).

- Venting:**
- To increase the fan speed: Press the Vent button (Fig. 95,1). The fan speed in the venting direction increases by one level. LEDs (Fig. 95,4) show the operating levels.
 - To lower the fan speed: Press the Aerate button (Fig. 95,3). The fan speed decreases by one level.
- Aerating:**
- To increase the fan speed: Press the Aerate button (Fig. 95,3). The fan speed in the aerating direction increases by one step. LEDs (Fig. 95,4) show the operating levels.
 - To lower the fan speed: Press the Vent button (Fig. 95,1). The fan speed decreases by one level.
- Boost function:**
- Press and hold the Aerate button for approx. 3 seconds. The fan switches to the maximum aeration level and then, after approximately 5 minutes, automatically switches back to the previously selected level.
 - Press and hold the Vent button for approx. 3 seconds. The fan switches to the maximum venting level and then, after approximately 5 minutes, automatically switches back to the previously selected level.
- Switching off:**
- Press the On/Off button (Fig. 95,2). The fan stops, the LEDs go out.

6.11.4 Skyroof skylight



- ▷ When opening the skylight, ensure that there are no torsional forces. Open and close the skylight evenly.
- ▷ If the catch lever is equipped with a safety knob, press the safety knob when operating the catch lever.

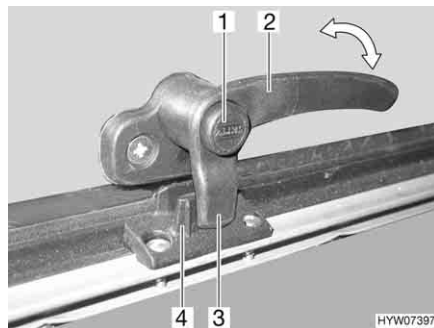

Fig. 96 Catch lever with safety knob in "closed" position

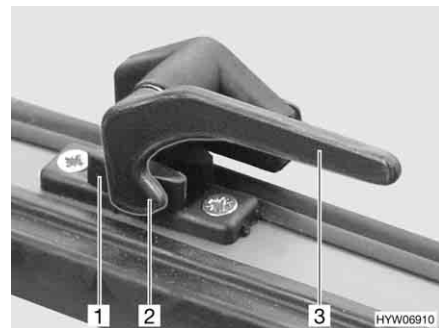

Fig. 97 Catch lever in "closed" position

- Opening:**
- Press and hold the security button (Fig. 96,1), if present.
 - Turn all catch levers (Fig. 96,2 or Fig. 97,3) a quarter turn towards the centre of the skylight.
 - Press and hold the security button, if present.

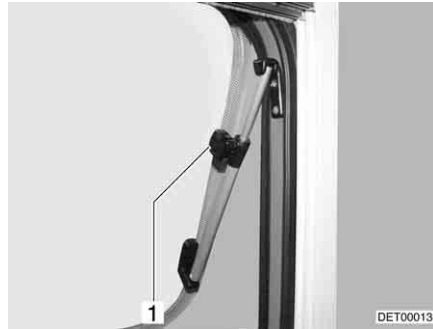

Fig. 98 Skylight with rotary hinges, open

- Open the skylight until the required position has been reached and use knurled knob (Fig. 98,1) to secure in position.

The skylight remains locked in the desired position.

Closing:

- Turn knurled knob (Fig. 98,1) until the latch is released.
- Close the skylight.
- Press and hold the security button (Fig. 96,1), if present.
- Turn all catch levers (Fig. 96,2 or Fig. 97,3) a quarter turn towards the frame. The locking catch (Fig. 96,3 or Fig. 97,2) is located on the inside of the skylight lock (Fig. 96,4 or Fig. 97,1).
- Press and hold the security button, if present.

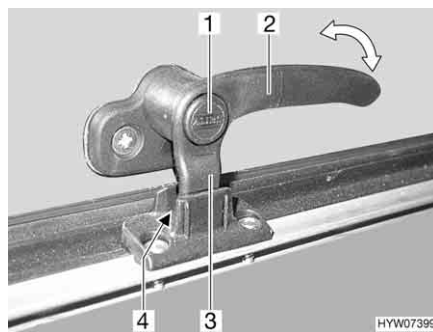

Fig. 99 Catch lever with safety knob in "continuous ventilation" position

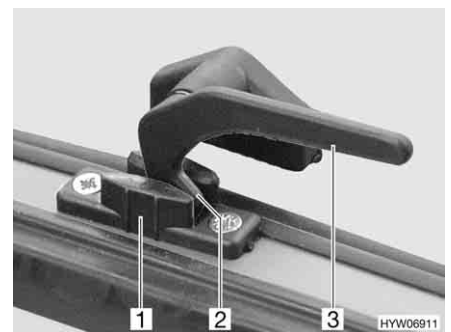

Fig. 100 Catch lever in "continuous ventilation" position

Continuous ventilation

With the catch levers, the skylight can be placed in 2 different positions:

- "Continuous ventilation" (Fig. 99 and Fig. 100)
- "Firmly closed" (Fig. 96 and Fig. 97)

To place the skylight into the "continuous ventilation" position:

- Press and hold the security button (Fig. 99,1), if present.
- Turn all catch levers (Fig. 99,2 or Fig. 100,3) a quarter turn towards the centre of the skylight.
- Slightly push the skylight outwards.
- Return all catch levers to their initial position. The locking catch (Fig. 99,3 or Fig. 100,2) has to be moved into the recess of the skylight lock (Fig. 99,4 or Fig. 100,1).
- Press and hold the security button, if present.

During the journey, the skylight may not be in the "continuous ventilation" position.

If it rains, the "continuous ventilation" skylight position could lead to splashing water penetrating the living area. Therefore, close the skylight completely.



- ▷ If the Roman shade is completely closed, heat can accumulate between the Roman shade and the glass windows when exposed to direct sunlight. The skylight could be damaged. For that reason, close the Roman shade only 2/3 of the way in direct sunlight. Open the skylight slightly or move it to ventilation position.



Fig. 101 Skyroof skylight

Roman shade The Roman shade is fitted in the frame, at the bottom.

- Closing:*
- Hold the Roman shade in the centre of the bottom rod and carefully draw it upwards.
 - Release the Roman shade at the desired position. The Roman shade will stay in that position.
- Opening:*
- Carefully return the bottom rod of the Roman shade downwards to the limit stop on the frame.

Insect screen The insect screen is fitted in the frame, at the top.

- Closing:*
- Hold the insect screen in the centre of the bottom rod and carefully pull it down.
 - Continuous adjustment of the insect screen may be made by moving the bottom rod.
- Opening:*
- Carefully return the bottom rod of the insect screen upwards to the limit stop on the frame.

6.12 Suspension table

Table leg The table leg can be set up at two different heights:

- Normal table height
- Decreased table height (when converting to a bed foundation)

To lower the table, there are the following possibilities (depending on model):

- Replacing the long table leg with a short one
- Folding in one part of the table leg
- Removing one part of the table leg

Table-top Depending on the model, the table-top can be extended.

Swing-out table extension

The table surface can be expanded by swinging out the table extension.



Fig. 102 Swing-out table extension

Expanding the table:

- Pull the knob (Fig. 102,3) of the lock down and swing out the table extension (Fig. 102,2).

Reducing the table size:

- Swing the table extension (Fig. 102,2) under the table-top (Fig. 102,1) until the lock latches in place audibly.

Insertable table extension

The suspension table size can be enlarged by inserting a table extension.



Fig. 103 Insertable table extension

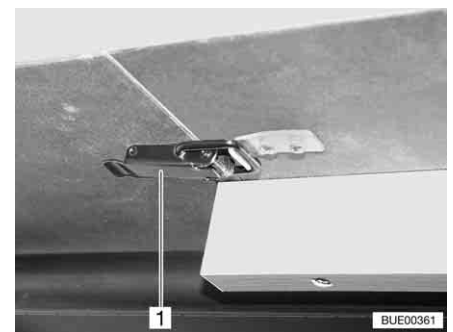

Fig. 104 Catch

Expanding the table:

- Open catches (Fig. 104,1).
- Raise the table-top (Fig. 103,2) slightly and pull it out as far as possible.
- Set down the table.
- Insert the table extension (Fig. 103,1) and secure it with the catch (Fig. 104,1).
- Lift the table-top slightly and push back as far as possible.
- Secure the table-top with the catches.

Reducing the table size:

- Open catches (Fig. 104,1).
 - Slightly lift the front of the table-top and pull out.
 - Remove table extension (Fig. 103,1) and lay it aside.
 - Lift the table-top slightly and push back as far as possible.
 - Set down the table.
 - Secure the table-top with the catches.
- ▷ The extension frame beneath the table-top is locked into the mounting rail. Release the lock before lifting the table-top.



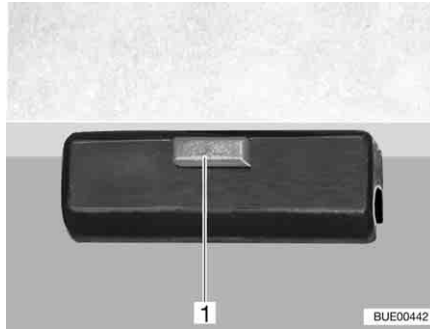

Fig. 105 Lock

Conversion to bed foundation:

- Lift the front of the table-top by approx. 45°.
- Depending on the model, shorten the table leg to the conversion level.
- Release the lock (Fig. 105,1) on the table top.
- Take the table-top out of the upper retainer.
- Hook the table-top at a 45° angle to the supports into the lower retainer and place on the floor with the shortened table leg.
- Lock the table-top.

6.13 Divan adjustment mechanism (only Argos 747-2)



- ▷ To avoid increased wear and tear of the cushion, push both sides of the seat cushion slightly inwards when folding the neck cushion downwards.

The "Reliner[®]" divan allows you to adjust the seat and fold the neck cushion down along the length of the seat. When the neck cushion is folded down along the divan, the divan can be used as a comfortable sleeping area or as an extra bed.

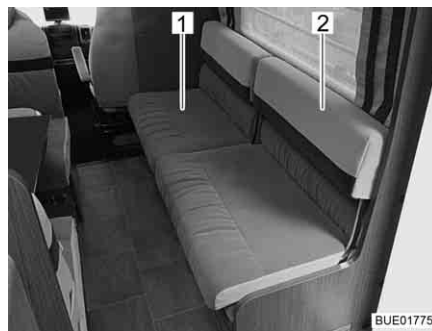

Fig. 106 Adjusting the seat



Fig. 107 Adjusting the neck cushion

Adjusting the seat:

- Slightly lift the seat (Fig. 106,1).
- Pull seat forward to the desired position and lower it.

Adjusting the neck cushion:

- Hold the neck cushion (Fig. 106,2) and carefully fold it downwards.
- Push the seat cushion slightly inwards in the area around the metal clip (Fig. 107,1).

6.14 Additional seat (only Argos 747-2)

Using a folding bench seat enlargement on the front bench, it is possible to create an additional seat or a comfortable lying surface.



Fig. 108 Folding bench seat enlargement

Using the additional seat:

- Fold up the bench seat enlargement (Fig. 108,1) on the front bench and lock into place.
- Place the supplied seat cushion on the bench seat enlargement.
- If required, move the Reliner® seat far enough forwards to create a continuous cushioned surface.

Removing the additional seat:

- Remove the seat cushion from the bench seat enlargement and store it securely.
- Unlock the bench seat enlargement on the front bench and fold it down.

6.15 Beds



- ▶ Always use the safety guards supplied.
- ▶ Never remove or dismantle the safety guards supplied.

6.15.1 Overcab bed



- ▶ The maximum permitted overcab bed load is 200 kg.
- ▶ Only use the overcab bed, if the safety net is set up.
- ▶ Never allow small children to remain in the overcab bed without supervision.
- ▶ But in particular with regard to small children less than 6 years of age, users should ensure that they cannot fall out of the overcab bed.
- ▶ Use separate children's beds or travel cots suitable for children.



- ▷ Do not load the overcab bed without mattress. The plastic mould part can break!

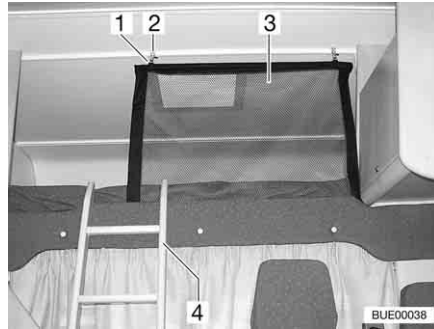

Fig. 109 Overcab bed

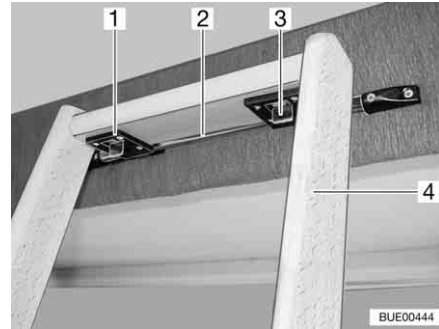

Fig. 110 Access ladder, catch

Access ladder

Always use the access ladder (Fig. 109,4 and Fig. 110,4) provided as standard to access the overcab bed.

Attaching:

- Hang the ladder with the two hooks (Fig. 110,1) on the rail (Fig. 110,2) of the alcove flap.
- Push the two catches (Fig. 110,3) forward.

Safety net

The safety net (Fig. 109,3) is stored as standard between the mattress and slatted frame. Only use the safety net if persons are already in the alcove.

Setting up:

- Attach the holder (Fig. 109,1) to the eyes on the ceiling (Fig. 109,2).

Folding mechanism

The overcab bed can be folded up. This simplifies passage from driver's cabin to living area.

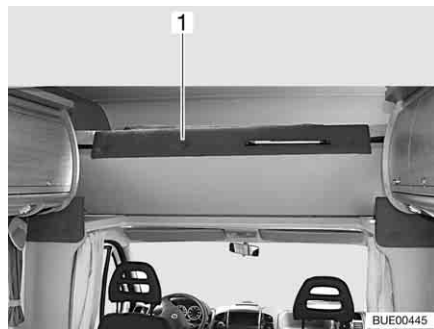

Fig. 111 Overcab bed, folded upwards

Folding upwards:

- If necessary, open the driver's cabin partition.
- Tip mattress backwards.
- Fold the front of the overcab bed (Fig. 111,1) upwards. The overcab bed is kept in the upper position by gas-pressure springs.

Folding downwards:

- Pull overcab bed downwards.
- Tip mattress forwards.

6.15.2 Fixed bed (gas-pressure springs)

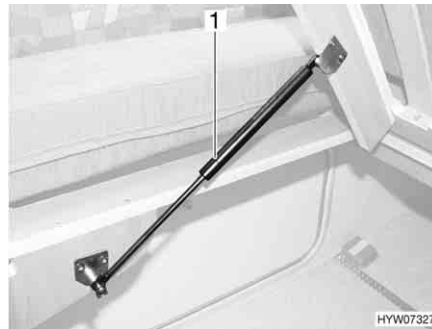

Fig. 112 Fixed bed

A storage compartment is underneath the bed. Lift up the slatted frame to place items in the storage compartment or to empty it from the inside of the vehicle.

- Opening:*
- Lift the mattress forwards.
 - Lift slatted frame. The gas-pressure springs (Fig. 112,1) hold the slatted frame open.
- Closing:*
- Press the slatted frame downwards against the resistance of the gas-pressure springs.

6.15.3 Fixed bed (adjustable head section)



▶ Do not let the slatted frame fall down when closing the bed!



Fig. 113 Adjustable head section

Depending on the configuration, the head section of the slatted frame can be adjusted in several stages.

- Raising the head section:*
- Raise the head section (Fig. 113,2) of the slatted frame to the desired position. The support (Fig. 113,1) locks automatically into place.

The head section remains locked in the required position.

- Lowering the head section:*
- Raise the head section (Fig. 113,2) of the slatted frame until the lock is released.
 - Guide the head section downwards slowly.

6.15.4 Bunk bed



- ▶ Only use the upper bunk bed if the safety guard is fitted.
- ▶ The maximum permitted bunk bed load is 100 kg.
- ▶ The upper bunk bed must not be used by children under 6 years of age.
- ▶ Never allow small children to remain in the bunk bed without supervision.
- ▶ But in particular with regard to small children less than 6 years of age, users should ensure that they cannot fall out of the bunk bed.
- ▶ Use separate children's beds or travel cots suitable for children.

Depending on the model, the vehicle is fitted with a bunk bed. The bunk bed can be used immediately, without additional conversion.

Always use the access ladder provided to climb up to the top bed.

6.16 Converting seating groups for sleeping

6.16.1 Central seating group (Argos 747-2)

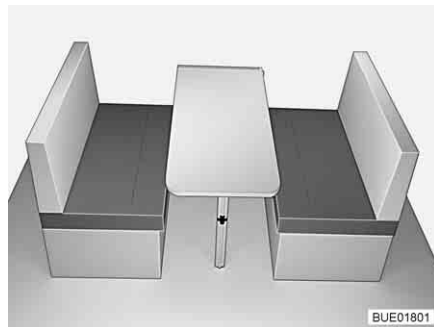

Fig. 114 Prior to conversion

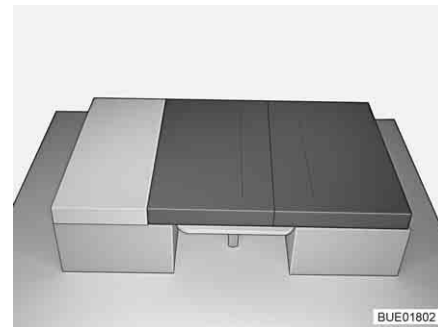

Fig. 115 After conversion

- Convert the table to a bed foundation (see section 6.12).
- Remove the back cushions.
- Pull one seat cushion onto the table.
- Place a back cushion between seat cushion and bench seat rear wall (see Fig. 115).

6.16.2 Central seating group with additional cushion (Argos time 650 and 660)

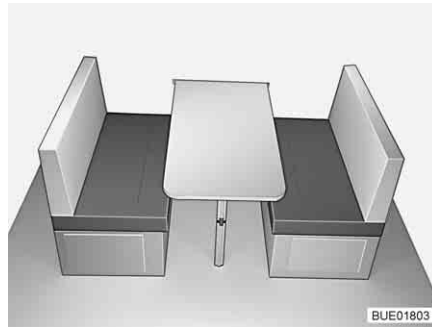

Fig. 116 Prior to conversion



Fig. 117 After conversion

- Convert the table to a bed foundation (see section 6.12).
- Unfold the bedding box extensions.
- Remove the back cushions.
- Pull one seat cushion onto the table.
- Pull the seat cushions into the centre.
- Insert the three-part additional cushion between the seat cushions and the wall.
- Place a back cushion between seat cushion and bench seat rear wall (see Fig. 117).

6.16.3 Bench with divan (Argos time 670)

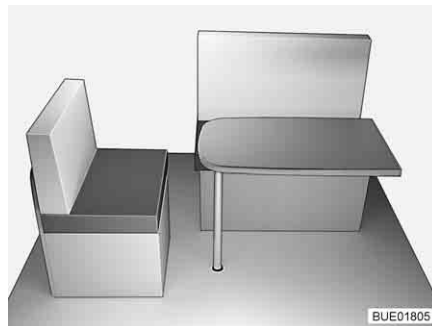

Fig. 118 Prior to conversion

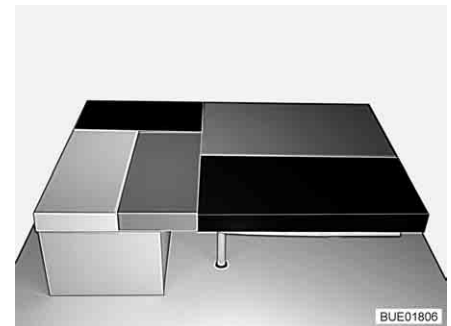

Fig. 119 After conversion

- Convert the table to a bed foundation (see section 6.12).
- Unfold bedding box extension of the divan.
- Attach the bed widening to the bedding box, to the divan, and to the bedding box extension.
- Remove the back cushion of the bench and lay it aside.
- Remove the back cushion of the divan.
- Pull the seat cushion of the divan onto the bedding box extension.
- Place the back cushion of the divan between seat cushion and wall.
- Place the large additional cushion on the table.
- Place the slim additional cushion on the bed widening on the divan (see Fig. 119).

6.17 Shower connection point for external shower (special equipment)



- ▶ Only use the external shower if there is a gap of at least 1.20 m between the shower and the nearest electrical device or connection. Risk of electric shock!



- ▷ If decommissioned for a longer time or if there is a risk of frost, drain the water system.

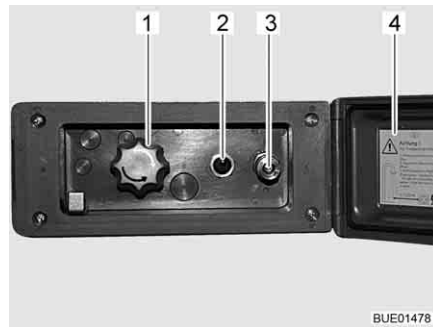

Fig. 120 External shower connection point

Connecting an external shower:

- Unlock and open the cover (Fig. 120,4).
- Attach hose of the external shower to the quick closure (Fig. 120,3).

Using the shower:

- Switch on the water pump using the switch (Fig. 120,2).
- Adjust the water temperature with the rotary knob (Fig. 120,1) as desired.
- Switch off the water pump using the switch (Fig. 120,2).

Shutting off the shower connection point:

- Switch off the water pump using the switch (Fig. 120,2).
- Disconnect the hose from the quick closure. The quick closure is equipped with a check valve to prevent any further water from escaping.
- Close the cover (Fig. 120,4) and lock with key.

Emptying:

- Attach hose of external shower to quick closure. The check valve is opened and the connections can run dry.
- Turn knob (Fig. 120,1) to the centre position.
- Empty the water system (see section 10.2.8).

Chapter overview

This chapter contains instructions regarding the gas system of the vehicle. The instructions address the following topics:

- safety
- changing the gas bottles
- gas isolator taps
- external gas connection
- automatic switching facility

The operation of the gas operation appliances of the vehicle is described in chapter 9.

7.1 General



- ▶ Before commencing the journey, when leaving the vehicle or when gas equipment is not in use, close all gas isolator taps and the main isolator tap on the gas bottle.
- ▶ All gas-operated devices (heater, cooker, oven, grill, refrigerator - depending on the equipment) must be switched off for refuelling, on ferries or in the garage. Danger of explosion!
- ▶ Do not use gas-operated devices in closed spaces (e.g. garages). Danger of poisoning and suffocation!
- ▶ Only have the gas system maintained, repaired or altered by an authorised specialist workshop.
- ▶ Have the gas system checked by an authorised specialist workshop according to the national regulations before commissioning. This also applies for not registered vehicles. For modifications to the gas system have the gas system immediately checked by an authorised specialist workshop.
- ▶ The gas pressure regulator and exhaust gas pipes must also be inspected. The gas pressure regulator has to be replaced after 10 years at the latest. The vehicle owner is responsible for seeing that this is carried out.
- ▶ In case of a defect of the gas system (gas odour, high gas consumption) there is danger of explosion! Close regulator tap on the gas bottle immediately. Open doors and windows and ventilate well.
- ▶ If the gas system is defective: Do not smoke; do not ignite any open flames, and do not operate electric switches (light switches etc.).
- ▶ Only the stipulated devices may be connected to internal connections. Do not operate any device outside the vehicle if it is connected to an internal connector.
- ▶ Before using the cooker make sure that there is sufficient ventilation. Open windows or the skylight.
- ▶ Do not use the gas cooker or gas oven for heating purposes.
- ▶ If there are several gas devices, each gas device must have its own gas isolator tap. If individual gas devices are not in use, close the respective gas isolator tap.
- ▶ Ignition safety valves must close within 1 minute after the gas flame has extinguished. A clicking sound is audible. Check function from time to time.



- ▶ The built-in gas devices are exclusively meant for use with propane or butane gas or a mixture of both. The gas pressure regulator as well as all built-in gas devices are designed for a gas pressure of 30 mbar.
- ▶ Propane gas is capable of gasification up to -42 °C, whereas butane gas gasifies at 0 °C. Below these temperatures no gas pressure is available. Butane gas is unsuitable for use in winter.
- ▶ Regularly inspect the gas tube fitted to the gas bottle connection for tightness. The gas tube must not have any tears and must not be porous. Have the gas tube replaced by an authorised specialist workshop no later than ten years after the manufacturing date. The operator of the gas system must see to it that the parts are replaced.
- ▶ Due to its function and construction, the gas bottle compartment is a space which is open to the exterior. Never cover or block up the standard forced ventilations. Otherwise gas that is emitted can not be diverted to the outside.
- ▶ The gas bottle compartment must not be used as storage space.
- ▶ Secure the gas bottle compartment against unauthorised access. To do this, lock the compartment.
- ▶ The regulator tap on the gas bottle must be accessible.
- ▶ Only connect gas-operated devices (e.g. gas grill) which have been designed for a gas pressure of 30 mbar.
- ▶ The exhaust gas pipe must be fitted tightly to the heating system and to the vent and must be sealed. The exhaust gas pipe must not show any evidence of damage.
- ▶ Exhaust fumes must be able to escape into the atmosphere unhindered and fresh air must be able to enter unhindered. For this reason, keep the exhaust pipe and intake openings clean and unobstructed (e.g. free from snow and ice). For this reason, no snow walls or aprons may lie against the vehicle.

7.2 Gas bottles



- ▶ Gas bottles are only to be transported within the designated gas bottle compartment.
- ▶ Place the gas bottles in vertical position in the gas bottle compartment.
- ▶ Fasten the gas bottles so that they are unable to turn or tilt.
- ▶ Connect the gas tube to the gas bottle without tension.
- ▶ If the gas bottles are not connected to the gas tube, always place the protective cap on top.
- ▶ Close the regulator tap on the gas bottle before the gas pressure regulator or gas tube are removed from the gas bottle.
- ▶ Use your hands only to connect the gas pressure regulator or the gas tube to the gas bottles. Do not use any tools.
- ▶ Only use special gas pressure regulators with a safety valve designed for vehicle use. Other gas pressure regulators are not permitted and cannot meet the demanding requirements.
- ▶ Use the gas pressure regulator defroster if the temperature falls below 5 °C.



- ▶ Use only 11 kg or 5 kg gas bottles. Camping gas bottles with built-in check valve (blue bottle with max. 2.5 or 3 kg content) are can be used in exceptional cases with a safety valve.
- ▶ Use the shortest possible tube lengths (150 cm max.) for external gas bottles.
- ▶ Never block the floor ventilation openings below the gas bottles.



- ▷ With some models, the gas bottle compartment is located right next to the conversion door. With these models, only open the gas bottle compartment when the conversion door is closed. Danger from damages.



- ▷ For gas-operated units the gas pressure must be reduced to 30 mbar.
- ▷ Connect gas pressure regulator complete with safety valve directly to bottle valve.
The gas pressure regulator reduces the gas pressure in the gas bottle down to the operating pressure of the gas devices.
- ▷ For filling and connecting the gas bottles in Europe the accessories shops have corresponding Euro filling sets and Euro bottle sets.
- ▷ Information available at the dealers or service centre.
- ▷ For information on the gas supply in Europe see chapter 17.

7.3 Changing gas bottles



- ▶ When changing gas bottles, do not smoke or create any open fire.
- ▶ When you have changed the gas bottle, check whether gas escapes at the connection points and unions. Use a leakage search spray to spray the relevant connection point or union. These agents are available at the accessories shop.

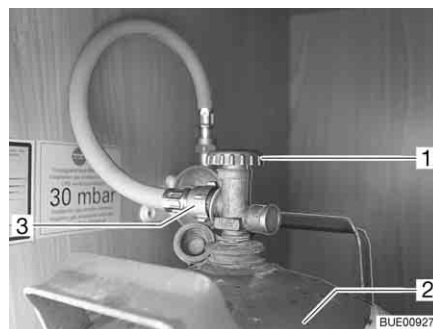
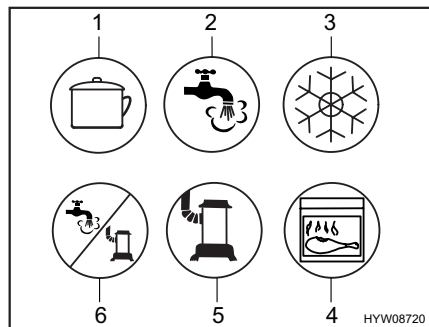

Fig. 121 Gas bottle compartment

- Open external gas bottle compartment (see chapter 6).
- Close the regulator tap (Fig. 121,1) on the gas bottle (Fig. 121,2). Pay attention to the direction of the arrow.
- Unscrew the gas tube (Fig. 121,3) by hand from the gas bottle.
- Release the fixing belts and remove the gas bottle.
- Place a filled gas bottle in the gas bottle compartment.
- Fix gas bottle in place with the fixing belts.
- Screw gas tube on gas bottle by hand.

7.4 Gas isolator taps



- 1 Cooker
- 2 Hot water
- 3 Refrigerator
- 4 Oven/grill
- 5 Heater
- 6 Hot water/heater

Fig. 122 Possible symbols for the gas isolator taps

A gas isolator tap (Fig. 122) for every gas device is built into the vehicle. The gas isolator taps are located in the vehicle at different positions, and can also be fitted separately. Generally, you will have access to the gas isolator taps in the kitchen unit opening a door or a drawer.

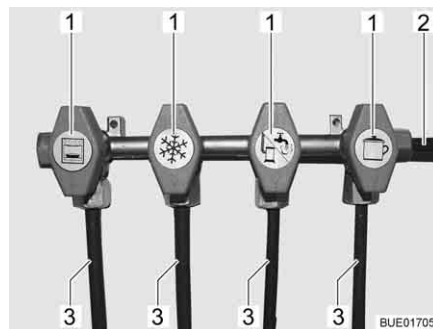

- 1 Gas isolator tap open
- 2 Gas pipe
- 3 Pipe to the appliance

Fig. 123 Gas shut-off valves position (example)

- Opening:**
- Position the gas isolator tap of the corresponding gas device parallel (Fig. 123,1) to the pipe (Fig. 123,3) leading to the device.
- Closing:**
- Position the gas isolator tap of the corresponding gas device transverse to the pipe leading to the gas device.

7.5 External gas connection (special equipment)



- ▶ If the external gas connection is not in use, always close the gas isolator tap.
- ▶ Only gas appliances with a suitable adapter should be connected to the external gas connection.
- ▶ Connect only external gas appliances which are designed for an operation pressure of 30 mbar.
- ▶ Once you have made the connection and opened the gas isolator tap, make sure that no gas is escaping at the connection point. If there is a leak in the external gas connection, gas will escape into the open air. Immediately close the gas isolator tap and the regulator tap on the gas bottle. Have the external gas connection checked by an authorised specialist workshop.



- ▶ When connecting an external gas appliance, make sure that there is nothing near the external gas connection that could cause a spark.
- ▶ Do not use the external gas connection to fill gas bottles. Observe the information stickers on the external gas connection.

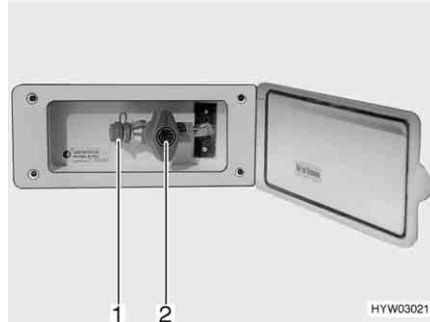

Fig. 124 External gas connection, gas isolator tap closed

The external gas connection (Fig. 124) is located at the rear or to the left or right of the vehicle depending on the model.

- Connect the external gas device to the connection point (Fig. 124,1).
- Open the gas isolator tap (Fig. 124,2).

7.6 Crash protection unit switching facility (special equipment)



- ▶ Do not use the switching facility in closed spaces.



- ▷ When the vehicle is equipped with the crash protection unit the living area heater may be operated during the journey.
- ▷ If the vehicle is equipped with a panel of the DT series and the switching facility is operated via this panel, the operating unit is redundant.
- ▷ Also read the manufacturer's instruction manual.

The crash protection unit is an automatic switching facility with a control unit for a two-bottle gas system. The switching facility automatically switches gas supply from the primary bottle to the reserve bottle as soon as the primary bottle is either empty or no longer ready for operation. The gas appliances may still continue operation. The switching facility is suitable for all commercial gas bottles from 3 kg to 33 kg. In the event of an accident or a too high angle of the vehicle the gas supply will automatically be interrupted.

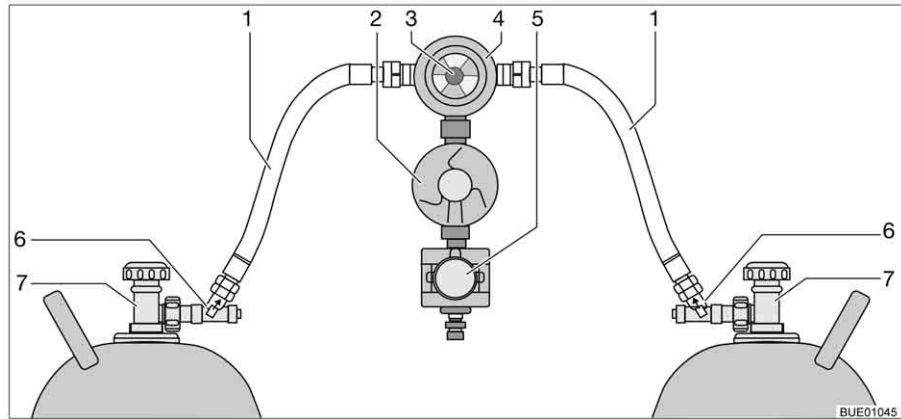

Fig. 125 Crash protection unit switching facility

Construction of the unit

The crash protection unit consists of two flow restrictors with manual release button (Fig. 125,6) a reversing valve (Fig. 125,4) with pressure regulator (Fig. 125,2), an electrovalve (Fig. 125,5) and the operating unit with tricoloured LED (Fig. 125,1).

Use the knob (Fig. 125,3) on the reversing valve to select which of the gas bottles is to be used as a primary bottle and which is to be used as a reserve bottle.



Fig. 126 Operating unit

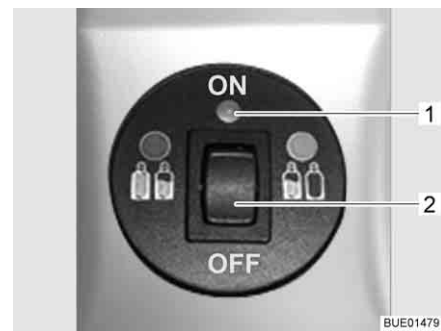

Fig. 127 Operating unit with remote display

Only the electrical functions can be switched at the operating unit (Fig. 126). The regulator taps on the gas bottles (Fig. 125,7) and the release buttons (Fig. 125,6) must be opened manually.

The reversing valve provides a constant gas pressure, regardless of which gas bottle is being drawn upon. The display in the reversing valve shows the filling level of the primary bottle. The gas supply comes from the primary bottle when the display is green. When the display is red the primary bottle is empty. In this case, the reserve bottle is used for the gas supply.

Without remote display

The indicator lamp on the operating unit shows the condition of the gas system. The system is okay when the indicator lamp (Fig. 126,1) lights up green. When the indicator lamp lights up or flashes red a fault has occurred. The gas supply is interrupted.

With remote display

The indicator lamp on the operating unit (Fig. 127,1) shows the condition of the gas system:

Indicator lamp	Signification
Off	System switched off, gas supply switched off
Green	System switched on, gas supply switched on
Red	Gas supply switched off, triggered by sloping position or excessive acceleration, e.g. in the event of an accident
Yellow	System switched on, gas supply switched on, primary bottle empty
Flashes yellow	Self-check, for approx. 2 seconds, after switching on
Flashes red once	Valve not connected to control unit or internal error
Flashes red twice	Overvoltage determined, gas supply interrupted
Flashes red three times	Undervoltage determined, gas supply interrupted

Putting into operation:

- Open the regulator taps of the gas bottles (Fig. 125,7).
- Press the release buttons (Fig. 125,6) successively for 10 seconds.
- Use the knob (Fig. 125,3) on the reversing valve (Fig. 125,4) to select the gas bottle which is to be the primary source of gas (primary bottle). Always turn the knob as far as it will go.
- Switch on the switching facility on the operating unit. For this, set the rocker switch (Fig. 126,2 or Fig. 127,2) to "ON". The reversing valve is now deaerated. The indicator lamp (Fig. 126,1 or Fig. 127,1) flashes yellow (system test) and lights up green.

Switching off:

- Set the rocker switch (Fig. 126,2 or Fig. 127,2) to "OFF". The indicator lamp (Fig. 126,1 or Fig. 127,1) goes out.
- Close the regulator taps of the gas bottles (Fig. 125,7).



- ▶ When changing gas bottles, do not smoke or create any open fire.

Changing gas bottles:

- Turn the knob on the reversing valve. The display is green again. Should the display stay red the reserve bottle is also empty and has to be changed as well.
- Close regulator tap on the empty gas bottle.
- Unscrew the gas tube of the gas bottle.
- Release the fixing belts and remove the gas bottle.
- Place a new gas bottle in the gas bottle compartment.
- Fix gas bottle in place with the fixing belts.
- Connect the full gas bottle to the gas tube.
- Open regulator tap on the gas bottle.
- Press the release button for 10 seconds.
- Turn the knob on the reversing valve to the changed bottle. Open the release button when the display is green.
- Set the knob on the reversing valve with a half-turn, so that the newly replaced gas bottle will serve as a reserve bottle.

Chapter overview

This chapter contains instructions regarding the electrical system of the vehicle.

The instructions address the following topics:

- safety
- explanations of terms relating to the battery
- USB socket
- 12 V power supply
- the radio selector switch
- starter battery
- living area battery
- transformer/rectifier
- panel
- fuel cell
- solar installation
- 230 V power supply
- connection to the 230 V power supply
- fuse rating
- external socket
- electrical wiring

The operation of the electrical appliances of the housing body is described in chapter 9.

8.1 General safety instructions



- ▶ Only allow qualified personnel to work on the electrical system.
- ▶ All electronic devices (e.g. mobile telephones, radios, televisions or DVD players) which have been retrofitted to the vehicle and are operated during the journey must have certain features: These are the CE certification, the EMC inspection (electromagnetic compatibility) and the "e"-inspection.

Only in this way can the functional reliability of the vehicle be ensured. Otherwise the airbag may be triggered or interference to the on-board electronics may result.



- ▷ After the vehicle is started, delays to the output or forwarding of electrical impulses are possible.

The control unit of the basic vehicle does not release the D+ signal until the engine has reached full performance. In the event of a cold start in winter, this can take up to 15 seconds.

For this reason, output of warning signals (such as "entrance step extended") may sometimes be delayed.

The automatic retraction of a SAT antenna can also be delayed.

- ▷ During a storm, to protect the electrical devices disconnect the 230 V connection and retract the antennae.

8.2 Terms

Off-load voltage

The off-load voltage is the voltage of the battery in idle condition, i.e. no current is consumed and the battery is not being charged.



- ▷ The battery must remain idle for a while before measuring. After charging the last time, or after the last current has been drained by consumers, wait approximately 2 hours before measuring the idle voltage.

Closed circuit current

Some electrical appliances, such as the clock and the indicator lamps, require continuous electric current, for this reason they are referred to as inactive appliances. This closed circuit current flows even if the device has been switched off.

Total discharge

Total discharge of the battery is imminent, if a battery is completely discharged by an active appliance and by closed circuit current and the off-load voltage falls below 12 V.



- ▷ Total discharge damages the battery.

Capacity

Capacity refers to the amount of electricity which can be stored in a battery.

The capacity of a battery is given in ampere hours (Ah). The so-called K20 value is normally used.

The K20 value indicates how much current a battery is able to dispense over a time period of 20 hours without causing damage, or how much current is required to charge a flat battery within 20 hours.

For example, if a battery can dispense 4 amps for 20 hours, then it has a capacity of $4 \text{ A} \times 20 \text{ h} = 80 \text{ Ah}$.

If more current flows, the capacity of the battery reduces proportionately.

External influences, such as temperature and age may alter the storage capacity of the battery. Capacity details refer to new batteries operating at room temperature.



- ▷ Depending on battery technology, capacity details have a conversion factor of 1.3 to 1.7, which lowers the real capacity by this value.

8.3 USB socket



- ▷ The charging current is maximum 1 amp.

The vehicle is equipped with a charging station with USB socket in the front part of the living area.

All USB devices can be connected and charged at this socket.



Fig. 128 USB socket

8.4 12 V power supply



- ▷ Only connect devices with a maximum of 10 A to the sockets (Fig. 129,1) of the 12 V power supply.

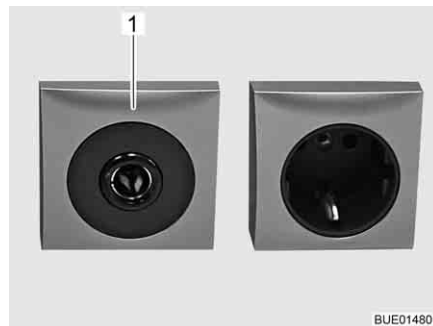

Fig. 129 12 V/10 A socket

8.4.1 Selector switch for radio (special equipment)



- ▷ Depending on the equipment level, a radio with integrated navigation device or a multimedia station will be present, referred to below simply as a "radio".
- ▷ The radio selector switch is installed in vehicles with Pioneer LCD display.



Fig. 130 Selector switch for operating behaviour

Switching the radio on and off with the ignition:

- Set the selector switch to the "0" position. The radio will be switched on and off with the ignition.

Operating the radio from the living area battery:

- Set the selector switch to the "1" position. The radio will be powered at all times from the living area battery.

8.4.2 Starter battery

The starter battery serves for starting the engine and supplies the electrical appliances of the base vehicle with voltage. See the instruction manual of the base vehicle for the position of the starter battery.



- ▷ The radio device in the driver's cabin is connected to the living area battery.

Discharging

This section contains information regarding the discharge of the starter battery.



- ▷ Total discharge damages the battery.
- ▷ Once a battery with acid is discharged, it can freeze in temperatures of below zero. This damages the battery.
- ▷ Recharge battery in good time.

The starter battery will be totally discharged via a closed circuit current (inactive appliances). Inactive appliances are optional devices such as a radio, alarm system, navigation system or a central locking system. Inactive appliances discharge the starter battery when the vehicle engine is switched off.

Low temperatures outside reduce the capacity available.

Charging This section contains information regarding the charging of the starter battery.



- ▶ The acid in the battery is poisonous and corrosive. Any contact with the skin or the eyes is to be avoided.
- ▶ In the case of charging with an external charger there is danger of explosion. Sparks can be caused by attaching the battery terminals. Only charge the battery in a well ventilated area and away from naked flames or possible sources of sparks. Batteries can develop and release gases.



- ▷ Before a temporary lay-up, charge the battery fully.
- ▷ Do not connect the battery cables to the wrong poles.
- ▷ If the starter battery or living area battery are disconnected, do not apply the ignition. There is a danger of short circuit from exposed cable ends.
- ▷ Before disconnecting or connecting the terminals of the battery, switch off the vehicle engine as well as the 230 V and 12 V power supplies and all appliances. Danger of short circuit!
- ▷ Observe the instruction manuals for the base vehicle and the charger.

The starter battery can only be fully charged with an external charger. When the vehicle is connected to the 230 V power supply, the transformer/rectifier charges the starter battery with a float charge only. Even in mobile operation, the vehicle engine alternator has a limited capability of completely charging the starter battery.

When charging the starter battery with an external charger, proceed as follows:

- Turn off the vehicle engine.
- Switch off the 12 V power supply on the panel. The indicator lamps or the displays on the panel go out.
- Switch off all gas appliances, all gas isolator taps and close the regulator tap on the gas bottle.
- Disconnect the starter battery from the vehicle (e.g. remove the battery terminals). There is a danger of short circuit when disconnecting the battery poles. For this reason, first disconnect the negative terminal on the starter battery and then the positive.
- Check that the external charger is turned off.
- Connect the external charger to the starter battery. Pay attention to the polarity: First connect the positive terminal "+" to the positive terminal of the starter battery, then connect the negative terminal "-" to the negative pole of the starter battery.
- Switch on the external charger.
- See the instructions for use of the connected charger for information concerning charge period required for the battery.
- See the specifications on the battery for information concerning its strength.
- Disconnect the charger in reverse order (the negative terminal first).
- Connect the battery terminals again (first the positive terminal).

8.4.3 Living area battery



- ▷ Use only the built-in transformer/rectifier to load the living area battery.
- ▷ After the trip, charge the living area battery fully.
- ▷ Before a temporary lay-up, charge the battery fully.
- ▷ When the living area battery is changed, only use batteries of the same type and the same capacity.
- ▷ If there are several living area batteries, always change all the batteries together. The batteries must **always** be the same age and have the same capacity.
- ▷ When changing the living area battery, use only batteries which meet the minimum capacity of the charger. Observe the separate instruction manual for the charger. Lower-capacity batteries will generate a great deal of heat when they are charged. Danger of explosion!
- ▷ If the living area battery is replaced and the charging unit does not provide at least 10 % of the rating of a new battery, install an auxiliary charging unit. Example: With a battery capacity of 80 Ah, the charging unit must supply at least 8 A charging current.
- ▷ Before disconnecting or connecting the terminals of the battery, switch off the vehicle engine as well as the 230 V and 12 V power supplies and all appliances. Danger of short circuit!
- ▷ If the starter battery or living area battery are disconnected, do not apply the ignition. There is a danger of short circuit from exposed cable ends.



- ▷ If possible, begin the trip with a fully charged living area battery. Therefore, charge the living area battery before starting the trip.
- ▷ During the trip, use every available opportunity to charge the living area battery.
- ▷ The radio device in the driver's cabin is connected to the living area battery.

When the vehicle is not connected to the 230 V power supply or the 230 V power supply is switched off, the living area battery supplies the living area with 12 V DC. The living area battery has a limited power supply only. For this reason, electrical appliances such as the radio and the lights should not be operated for a long time without using the 230 V power supply.

Position See chapter 16.

Discharging

The living area battery is discharged by the closed circuit current which some electrical appliances continuously require.



- ▷ Total discharge damages the battery.
- ▷ Recharge battery in good time.

Even a fully charged living area battery can, after an extended period, be fully discharged via a closed-circuit current (inactive appliances).

Low temperatures outside reduce the capacity available.

The self-discharge rate of the battery is also dependant on temperature. At 20 to 25 °C the self-discharge rate is approx. 3 % of the capacity per month. The self-discharge rate will increase with rising temperatures: At 35 °C the self-discharge rate is approx. 20 % of the capacity per month.

An older battery no longer has the complete capacity available.

The higher the number of active electrical appliances, the faster the energy of the living area battery is consumed.

Charging

The living area battery is charged via the transformer/rectifier.

If the vehicle engine is not running and the vehicle is connected to an external 230 V power supply, the living area battery will be charged via the external 230 V power supply.

When the vehicle engine is running, a relay in the transformer/rectifier connects the living area battery and the starter battery and charges them via the vehicle generator.



- ▷ Charge the battery for at least 48 hours after a total discharge.

8.5 Transformer/rectifier

8.5.1 Transformer/rectifier (EBL 99)



- ▷ Do not cover the ventilation slots. Danger of overheating!



- ▷ Depending on the model, not all slots for the fuses are occupied.
- ▷ If there are several living area batteries, use an auxiliary charging unit.
- ▷ Further information can be obtained in the manufacturer's instruction manual.

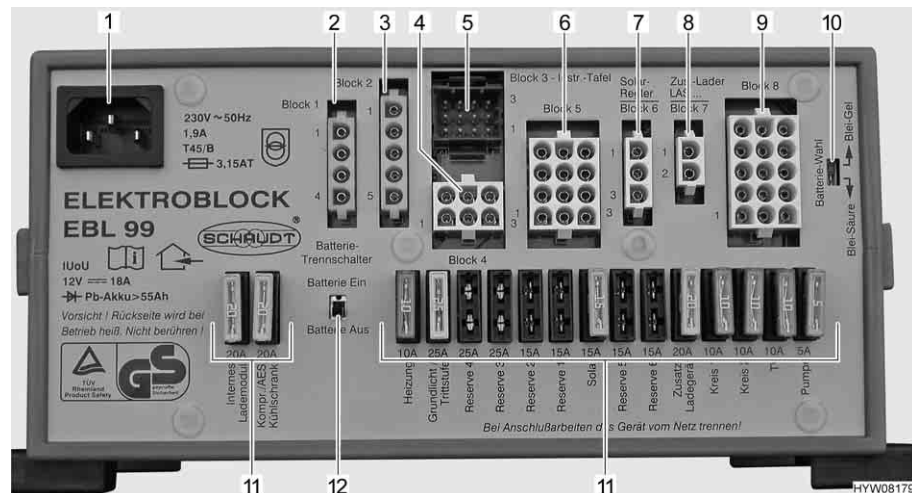

Fig. 131 Transformer/rectifier (EBL 99)

- 1 Main supply socket 230 V~
- 2 Block 1: Refrigerator output (D+, heating cartridge)
- 3 Block 2: Refrigerator output from starter battery, alternator D+
- 4 Block 4: Heating output, basic light (lighting in the entrance area), entrance step
- 5 Block 3: Panel outlet
- 6 Block 5: Reserve output 2, reserve 3, reserve 4, appliance with constant positive (e.g. satellite device, defroster)
- 7 Block 6: Solar charge regulator input (if fitted)
- 8 Block 7: Auxiliary charging unit input, fuel cell
- 9 Block 8: Appliance circuit output 1, appliance circuit 2, TV, water pump, reserve 1, reserve 5, reserve 6
- 10 Battery selector switch ("Blei-Säure/Blei-Gel" (lead acid/dryfill))
- 11 Fuses
- 12 Battery cut-off switch ("Batterie Ein/Aus" (battery On/Off))

Functions The transformer/rectifier has the following functions:

- The transformer/rectifier charges the living area battery. The transformer/rectifier charges the starter battery with a float charge only.
- The transformer/rectifier monitors the voltage in the living area battery.
- The transformer/rectifier distributes the current to the 12 V circuits and secures them. Devices with a maximum of 10 A can be connected to the sockets.
- The transformer/rectifier provides connections for a solar charge regulator, an auxiliary charging unit, as well as other control and monitoring functions.
- When the engine is turned off, the transformer/rectifier separates the starter battery electrically from the living area battery. This prevents the 12 V living area appliances from discharging the starter battery.
- The battery cut-off switch in the transformer/rectifier separates all the appliances from the living area battery.

The transformer/rectifier only works in conjunction with a panel.

The power in the transformer/rectifier (> 18 A) is divided into charging current and current to the appliances. The charging current is always just the portion that is not being used by any appliances. If the current to the appliances exceeds the current available, then the living area battery is discharged.

Position See chapter 16.

Battery cut-off switch

The battery cut-off switch switches off **all** the appliances in the living area, even inactive ones. Even appliances such as the entrance step, basic lighting or the refrigerator will stop working. This prevents the living area battery from slowly discharging if the vehicle is not used for a longer period of time (e.g. temporary lay-up).

If the vehicle is connected to the 230 V power supply, the batteries can then be charged from the transformer/rectifier, even if the battery cut-off switch is switched off.

This also applies for charging via a solar installation or fuel cell.

Battery selector switch

- ▶ If the battery selector switch is set incorrectly, there is the danger of the formation of detonating (oxy-hydrogen gas). Danger of explosion!



- ▷ Incorrect setting of the battery selector switch damages the living area battery.
- ▷ The factory settings of the battery selector switch must not be changed.

Battery monitor

- ▷ You must fully recharge a discharged living area battery as soon as possible.

The battery monitor in the transformer/rectifier monitors the voltage in the living area battery.

If the battery voltage falls below 10.5 V, the battery monitor in the transformer/rectifier switches off all the 12 V appliances.

Measures:

- Switch off all electrical appliances that are not absolutely essential at the corresponding switch.
- If necessary, use the 12 V main switch to switch the 12 V power supply back on for a short while. This is only possible, however, when the battery voltage is above 11 V. If the voltage is below this level, the 12 V power supply cannot be switched on again until the living area battery has been recharged.

Charging the battery

When the vehicle engine is running, a relay in the transformer/rectifier alternator switches on the living area battery and the starter battery together and recharges them with the vehicle generator. When the vehicle engine is switched off, the batteries are automatically disconnected from one another again by the transformer/rectifier. This prevents the starter battery from being run down by electrical appliances in the living area. The starting capability of the vehicle is thus preserved. The terminal voltage of the living area battery or the starter battery can be read on the panel.

If the vehicle is connected to the 230 V power supply, the living area battery and the starter battery are automatically charged by the charger module on the transformer/rectifier. The starter battery is only charged with a float charge. The charging current is adapted to suit the charging condition of the battery. This ensures that it is not possible to overload the battery.

To make use of the maximum output from the charger module on the transformer/rectifier, switch off all electrical appliances during charging.

- The transformer/rectifier provides connections for a solar charge regulator, an auxiliary charging unit, as well as other control and monitoring functions.
- When the engine is turned off, the transformer/rectifier separates the starter battery electrically from the living area battery. This prevents the 12 V living area appliances from discharging the starter battery.

The transformer/rectifier only works in conjunction with a panel.

The power in the transformer/rectifier (> 18 A) is divided into charging current and current to the appliances. The charging current is always just the portion that is not being used by any appliances. If the current to the appliances exceeds the current available, then the living area battery is discharged.

Position See chapter 16.

Battery separation



- ▷ Also switch off a refrigerator with automatic power selection system. The refrigerator will otherwise switch to gas operation.
- ▷ After deactivation of the battery separation, it may be necessary to reset the date and time. The remaining settings will be saved at the activation of the battery separation and will be maintained.

The battery separation switches off **all** 12 V appliances in the living area, even inactive ones. Even appliances such as the entrance step, basic lighting or the refrigerator will stop working. This prevents the living area battery from slowly discharging if the vehicle is not used for a longer period of time (e.g. temporary lay-up).

If the vehicle is connected to the 230 V power supply, the batteries can then be charged from the transformer/rectifier, even if the battery separation is activated.

This also applies for charging via a solar installation or fuel cell.

Activating/deactivating See section 8.7.2

Battery selector switch



- ▶ If the battery selector switch is set incorrectly, there is the danger of the formation of detonating (oxy-hydrogen gas). Danger of explosion!



- ▷ Incorrect setting of the battery selector switch damages the living area battery.
- ▷ The factory settings of the battery selector switch must not be changed.

Battery monitor



- ▷ You must fully recharge a discharged living area battery as soon as possible.

The battery monitor in the transformer/rectifier monitors the voltage in the living area battery.

If the battery voltage falls below 10.5 V, the battery monitor in the transformer/rectifier switches off all the 12 V appliances.

- Measures:*
- Switch off all electrical appliances that are not absolutely essential at the corresponding switch.
 - If necessary, use the 12 V main switch to switch the 12 V power supply back on for a short while. This is only possible, however, when the battery voltage is above 11 V. If the voltage is below this level, the 12 V power supply cannot be switched on again until the living area battery has been recharged.

Charging the battery

When the vehicle engine is running, a relay in the transformer/rectifier alternator switches on the living area battery and the starter battery together and recharges them with the vehicle generator. When the vehicle engine is switched off, the batteries are automatically disconnected from one another again by the transformer/rectifier. This prevents the starter battery from being run down by electrical appliances in the living area. The starting capability of the vehicle is thus preserved. The terminal voltage of the living area battery or the starter battery can be read on the panel.

If the vehicle is connected to the 230 V power supply, the living area battery and the starter battery are automatically charged by the charger module on the transformer/rectifier. The starter battery is only charged with a float charge. The charging current is adapted to suit the charging condition of the battery. This ensures that it is not possible to overload the battery.

To make use of the maximum output from the charger module on the transformer/rectifier, switch off all electrical appliances during charging.

8.6 Panel IT 96-2 (Argos Time)

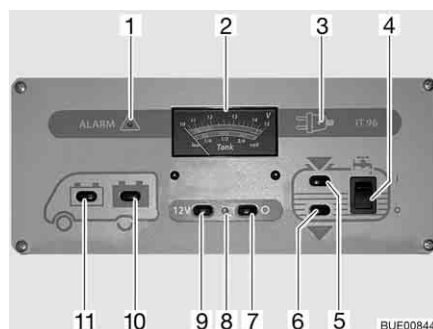

Fig. 133 Panel IT 96-2

- 1 "ALARM" warning light for the living area battery
- 2 V/tank gauge
- 3 230 V indicator lamp
- 4 Rocker switch for water pump On/Off
- 5 Switch for reading the filling level in the water tank
- 6 Switch for reading the filling level in the waste water tank
- 7 12 V main switch OFF
- 8 12 V indicator lamp
- 9 12 V main switch ON
- 10 Switch for reading the battery voltage of the living area battery
- 11 Switch for reading the battery voltage of the starter battery

8.6.1 12 V main switch

The 12 V main switch (Fig. 133,7 and 9) switches the panel and the 12 V power supply to the living area on and off.

Exception: Depending on the model, heater, basic light (lighting in the entrance area), entrance step, spare 4 and a refrigerator with automatic power selection system (AES) remain ready to operate.

- Switching on:*
- Press switch (Fig. 133,9) "12 V": The 12 V living area power supply is switched on. The indicator lamp (Fig. 133,8) lights up green.

- Switching off:*
- Press switch (Fig. 133,7) "O": The 12 V living area power supply is switched off. The indicator lamp (Fig. 133,8) goes out.



- ▷ When leaving the vehicle, switch off the main 12 V power supply at the panel. This prevents any unnecessary discharge of the living area battery.
- ▷ Appliances, such as control units (e.g. solar charge regulator, defroster or panel) or fitted appliances (e.g. heating, refrigerator or step) continue to take power from the battery capacity, even if the 12 V power supply on the panel is switched off. Therefore disconnect the living area battery from the 12 V power supply via the switch on the transformer/rectifier if the vehicle will not be used for a long period of time.

8.6.2 V/tank gauge for battery voltage and water or waste water levels

Battery voltage

The V/tank gauge is for the indication of the battery voltage of the starter battery or the living area battery.

With the V/tank gauge (Fig. 133,2), note the top scale. The gauge automatically lights up as soon as a switch is pressed.

Displays:

- Press switch (Fig. 133,11) "☰": The battery voltage of the starter battery is displayed.
- Press switch (Fig. 133,10) "☷": The battery voltage of the living area battery is displayed.

The following tables will help you correctly interpret the battery voltage of the living area battery displayed on the panel IT 96.

Danger of total discharge (battery alarm)

Battery voltage (values during operation)	Mobile operation (vehicle moving, no 230 V connection)	Battery operation (vehicle stationary, no 230 V connection)	Power operation (vehicle stationary, 230 V connection)
11 V or less ¹⁾	12 V power supply overload	If appliances are switched off: Battery flat	12 V power supply overload
	The battery is not charged by the alternator, the alternator's regulator is defective	If appliances are switched on: Battery overload	The battery is not charged by the transformer/rectifier, the transformer/rectifier is defective
11.5 V to 13.2 V	12 V power supply overload ²⁾	Normal range	12 V power supply overload ²⁾
	The battery is not charged by the alternator, the alternator's regulator is defective		The battery is not charged by the transformer/rectifier, the transformer/rectifier is defective

Battery voltage (values during operation)	Mobile operation (vehicle moving, no 230 V connection)	Battery operation (vehicle stationary, no 230 V connection)	Power operation (vehicle stationary, 230 V connection)
13.3 V to 13.7 V	Battery is being charged (main charge)	Occurs only briefly after charging	Battery is being charged (main charge)
13.8 V to 14.4 V	Battery being charged (float charge)	–	Battery being charged (float charge)
Over 14.5 V	Battery is over-charged, defective alternator control	–	Battery is over-charged, defective transformer/rectifier

- 1) The battery guard switches all the appliances off (at 10.5 V).
- 2) If the voltage does not exceed this range for several hours.

Values for off-load voltage	Charging condition of the battery
Less than 11 V	Totally discharged
12.0 V	0 %
12.2 V	25 %
12.3 V	50 %
12.5 V	75 %
More than 12.8 V	100 %



- ▷ Total discharge causes irreparable damage to the battery.





- ▷ Measure the off-load voltage preferably several hours after the previous charging (e.g. in the morning) and not directly after a current drain.

Volume of water/waste water

The V/tank gauge is for the indication of the quantity of water or waste water. With the V/tank gauge (Fig. 133,2), use the bottom scale. The gauge automatically lights up as soon as a switch is pressed.

Displays:

- Press switch (Fig. 133,5) : The volume of water is displayed.
- Press switch (Fig. 133,6) : The volume of waste water is displayed.
- ▷ Only read the tank levels briefly. Keeping the reading option on for a long time can damage the transducers.



8.6.3 Switch for water pump

Switching on: ■ Press the upper part of the rocker switch (Fig. 133,4) "I": The water supply is ON.

Switching off: ■ Press the lower part of the rocker switch (Fig. 133,4) "O": The water supply is OFF.



- ▷ If the vehicle is not connected to the 230 V power supply and the water pump is not used for a longer period of time: Switch off the power supply for the water pump. The pump relay uses around 4 Ah current each day.

8.6.4 Battery alarm for the living area battery

The red "ALARM" warning light (Fig. 133,1) flashes as soon as the voltage of the living area battery falls below 11 V (measured under operation) and there is a risk of a total discharge.



- ▷ Total discharge damages the battery.



- ▷ If the battery voltage falls below 10.5 V, the battery monitor in the transformer/rectifier switches off all the 12 V appliances. The battery cut-off switch is activated.

Measures: ■ When the battery alarm comes on, switch off the appliances and charge the living area battery, either by mobile operation or by connection to a 230 V power supply.

8.6.5 12 V indicator lamp

The 12 V indicator lamp (Fig. 133,8) illuminates whenever the 12 V main switch (Fig. 133,9) is switched on.

8.6.6 230 V indicator lamp

The yellow 230 V indicator lamp (Fig. 133,3) illuminates whenever line voltage is available at the transformer/rectifier input.



- ▷ Further information can be obtained in the manufacturer's instruction manual.

8.7 Panel LT 510 (Argos 747-2)



- ▷ The luminance of the LEDs and the symbols adapts automatically to the ambient light.
- ▷ The displays can only be called up if the 12 V power supply is switched on.
- ▷ As soon as a button is pressed, the gauge is automatically illuminated. The display goes out 20 seconds after the last key has been pressed.
- ▷ Further information can be obtained in the manufacturer's instruction manual.

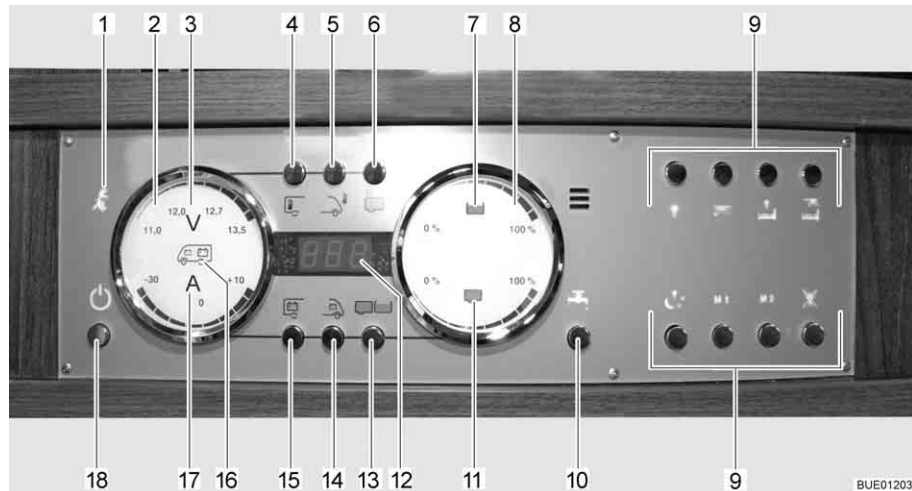

Fig. 134 Panel LT 510

- 1 230 V indicator lamp
- 2 Batteries gauge
- 3 Volt symbol
- 4 Interior temperature button
- 5 External temperature button
- 6 Tank heater button
- 7 Water tank symbol
- 8 Tanks gauge
- 9 Light control button
- 10 Water pump button
- 11 Waste water tank symbol
- 12 Digital display, temperature
- 13 Tanks button
- 14 Starter battery button
- 15 Living area battery button
- 16 Symbol for starter battery and living area battery
- 17 Ampere symbol
- 18 Button for 12 V power supply (12 V main switch)

8.7.1 230 V indicator lamp

The 230 V indicator lamp (Fig. 134,1) illuminates whenever line voltage is available at the transformer/rectifier input.



- ▷ The 230 V indicator lamp also lights up whenever the 12 V main switch is switched off.

8.7.2 12 V main switch

The 12 V main switch (Fig. 134,18) switches the panel and the 12 V power supply of the living area on and off.

Exception: Heater, basic light (lighting in the entrance area) and entrance step remain operational.

- Switching on:*
- Briefly press the 12 V power supply button (Fig. 134,18). The 12 V living area power supply is switched on. The "12 V" indicator lights up.



- ▷ If, after switching on, the "11.0" LED of the volt indicator and the "V" volt symbol (Fig. 134,3) in the batteries gauge (Fig. 134,2) flash, the voltage of the living area battery is too low. Charge battery.
- ▷ If, after switching on, the "12 V" indicator and the "V" volt symbol (Fig. 134,3) flash three times, battery separation is activated. Deactivate battery separation.

Switching off:

- Briefly press the 12 V power supply button (Fig. 134,18). The 12 V living area power supply is switched off. The "12 V power supply" indicator goes out.

Activating battery separation (transformer/rectifier without battery cut-off switch):

- Switch off 12 V power supply.
- Press button for living area battery (Fig. 134,15) and hold it down for approx. 10 seconds. The "V" volt symbol (Fig. 134,3) and the "12 V" indicator flash three times. The living area battery is disconnected from the 12 V power supply.

Deactivating battery separation (transformer/rectifier without battery cut-off switch):

- Press the 12 V power supply button (Fig. 134,18) and hold it down for approx. 5 seconds. The "V" volt symbol (Fig. 134,3) and the "12 V" indicator flash three times. The living area battery is connected to the 12 V power supply. The indicator lights up after approx. 5 seconds.



- ▷ When leaving the vehicle, switch off the main 12 V power supply at the panel. This prevents any unnecessary discharge of the living area battery.
- ▷ Appliances, such as control units (e.g. solar charge regulator, defroster or panel) or fitted appliances (e.g. heating, refrigerator or step) continue to take power from the battery capacity, even if the 12 V power supply on the panel is switched off. Therefore disconnect the living area battery from the 12 V power supply via the switch on the transformer/rectifier if the vehicle will not be used for a long period of time.

8.7.3 Batteries gauge

The voltage and charging/discharging of the living area battery or the starter battery voltage can be indicated using the batteries gauge.

Displays:

- Press button for living area battery (Fig. 134,15). The "V" volt symbol (Fig. 134,3) lights up. The "A" ampere symbol (Fig. 134,17) lights up as either white or red depending on whether it is charging or discharging. The battery voltage and electricity of the living area battery are displayed via the LEDs in the gauge.
- Press button for starter battery (Fig. 134,14). The "V" volt symbol (Fig. 134,3) lights up. The battery voltage of the starter battery is displayed using the LEDs in the gauge.

The tables below will help you interpret the statuses displayed on the panel.

Volt indicator (blue)

1 LED	2 LEDs	3 LEDs	4 LEDs	5 LEDs	6 LEDs	7 LEDs	8 LEDs
< 11.0 V	11.5 V	12.0 V	12.2 V	12.5 V	12.7 V	13.0 V	> 13.5 V

Danger of total discharge (battery alarm)

Battery voltage (values during operation)	Mobile operation (vehicle moving, no 230 V connection)	Battery operation (vehicle stationary, no 230 V connection)	Power operation (vehicle stationary, 230 V connection)
11 V or less ¹⁾	12 V power supply overload The battery is not charged by the alternator, the alternator's regulator is defective	If appliances are switched off: Battery flat If appliances are switched on: Battery overload	12 V power supply overload The battery is not charged by the transformer/rectifier, the transformer/rectifier is defective
11.5 V to 13 V	12 V power supply overload ²⁾ The battery is not charged by the alternator, the alternator's regulator is defective	Normal range	12 V power supply overload ²⁾ The battery is not charged by the transformer/rectifier, the transformer/rectifier is defective
Over 13.5 V	Battery is being charged (main charge)	Occurs only briefly after charging	Battery is being charged (main charge)

¹⁾ The battery guard switches all the appliances off (at 10.5 V).

²⁾ If the voltage does not exceed this range for several hours.

Values for off-load voltage	Charging condition of the battery
Less than 11 V	Totally discharged
12.0 V	0 % (discharged)
12.2 V	25 %
12.3 V	50 %
12.5 V	75 %
More than 12.8 V	Full



▷ Total discharge causes irreparable damage to the battery.



▷ Measure the off-load voltage preferably several hours after the previous charging (e.g. in the morning) and not directly after a current drain.

Ampere indicator (blue)

1 LED	2 LEDs	3 LEDs	4 LEDs	5 LEDs	2 LEDs	3 LEDs	4 LEDs
Discharging with:					Charging with:		
Ap- prox. 0 A	> 1 A	> 3 A	> 10 A	> 30 A	> 1 A	> 3 A	> 10 A

Current displayed	System status	"A" ampere symbol
-30 A to -10 A	Battery is being heavily discharged	Lights up red
-10 A to -1 A	Battery is being discharged	Lights up white
0 A	Battery current is low or 0 A	Lights up white
+1 A to +10 A	Battery is being charged	Lights up white

8.7.4 Tank gauge

The water and waste water quantities can be indicated using the tank gauge.

Displays:

- Press tanks button (Fig. 134,13). The water tank (Fig. 134,7) and waste water tank (Fig. 134,11) symbols light up. The fill levels of the water tank (upper scale) and of the waste water tank (lower scale) are indicated using the LEDs in the gauge.

The table below will help you interpret the levels displayed on the panel.

Level indicator (blue)

1 LED	2 LEDs	3 LEDs	4 LEDs	5 LEDs	6 LEDs	7 LEDs	8 LEDs
25 %		50 %		75 %		100 %	

8.7.5 Alarms

- ▷ Perform display checks regularly.
- ▷ It is best to perform checks in the morning, before the 12 V appliances are switched on.

The table below will help you interpret the alarms displayed on the panel.



- ▷ Total discharge damages the battery.



- ▷ If the battery voltage falls below 10.5 V, the battery monitor in the transformer/rectifier switches off all the 12 V appliances. The battery cut-off switch is tripped.

Display	Signification	Remedy
The "V" volt symbol (Fig. 134,3) and the LED "11.0" flash when the values for the living area battery are called up	The battery voltage has fallen below 11 V. Danger of total discharge	Switch off all 12 V appliances and charge the battery either by mobile operation or by connection to a 230 V supply
The "V" volt symbol (Fig. 134,3) flashes when the 12 V power supply is switched off	The 12 V power supply can no longer be switched on	Switch off all 12 V appliances and charge the battery either by mobile operation or by connection to a 230 V supply
	Battery overvoltage	Contact customer service
The "V" volt symbol (Fig. 134,3) and the LEDs "11.0" and "12.0" flash when the values for the starter battery are called up	The battery voltage has fallen below 11 V. Danger of total discharge	Switch off all 12 V appliances and charge the battery either by mobile operation or by connection to a 230 V supply

Tank alarm The water tank symbol (Fig. 134,7) or waste water tank symbol (Fig. 134,11) flashes when the water tank is empty or the waste water tank is full.



▷ If, when the fill levels are called up, the LEDs in the scale flash in addition to the tank symbol, a sensor error has occurred. Clean tank sensors.

Measures: ■ Fill water tank or empty waste water tank.

8.7.6 Temperature display

The internal and external temperatures can be indicated using the digital display (Fig. 134,12).

Displays: ■ Press the button for the internal temperature (Fig. 134,4). The internal temperature is displayed.
 ■ Press external temperature button (Fig. 134,5). The external temperature is displayed.

8.7.7 Switch for tank heater

The tank heater can be turned on and off using the tank heater button (Fig. 134,6).

Switching on: ■ Press the tank heater button (Fig. 134,6). The tank heater symbol lights up.

Switching off: ■ Press the tank heater button (Fig. 134,6). The tank heater symbol goes out.



▷ The tank heater is not switched off when the 12 V power supply is switched off. The tank heater must always be switched off separately. Although the tank heater can be switched off when the 12 V power supply is switched off, it cannot be switched on.

8.7.8 Switch for water pump

The water pump can be turned on and off using the water pump button (Fig. 134,10).

Switching on: ■ Press the water pump button (Fig. 134,10). The symbol lights up.

Switching off: ■ Press the water pump button (Fig. 134,10). The symbol goes out.



- ▷ The switch status of the water pump is saved when the 12 V power supply is switched off. This means: If the water pump was switched on when the 12 V power supply was switched off, it is also switched on after the 12 V power supply is switched back on.

8.8 Fuel cell (EFOY) (special equipment)



- ▶ Methanol is toxic. Avoid inhaling, swallowing or any contact with the skin or the eyes.
- ▶ If methanol leaks, there is a danger of fire. Keep away from sources of ignition and ventilate well. Methanol evaporates without residue.
- ▶ Always adhere to the safety data sheet from the manufacturer.
- ▶ The fuel cell must not be opened.
- ▶ The tank cartridge must not be opened with force or refilled.
- ▶ Keep fuel cell and tank cartridges – including empty or half-empty tank cartridges – out of the reach of children.
- ▶ When used in vehicles, the fuel cell and the tank cartridges must be secured to avoid accidents.



- ▷ Do not store the fuel cell at temperatures above 45 °C or below 1 °C.
- ▷ Do not operate the fuel cell at temperatures above 40 °C or below -20 °C.
- ▷ When the appliance is connected to an intact battery, the frost protection switches on automatically if the ambient temperature drops below 3 °C, even if the fuel cell is switched off. Therefore always connect a full tank cartridge and a sufficiently charged battery, if it is stored below 3 °C.
- ▷ If the fuel cell freezes despite taking all precautions, leave the appliance to defrost at room temperature for approx. 24 hours in a switched off state. Then it can be used again.
- ▷ Do not cover the ventilation holes on the fuel cell. Danger of overheating!
- ▷ The fuel cell is not waterproof. Clean casing only with a slightly damp cloth and ensure that water does not enter the device.



- ▷ The minimum running time of the fuel cell is 30 minutes. If the On/Off button is pressed during this period, the fuel cell only shuts down when this minimum operating time expires. The LEDs light up on during this time.
- ▷ Further information can be obtained in the instruction manual for the fuel cell.

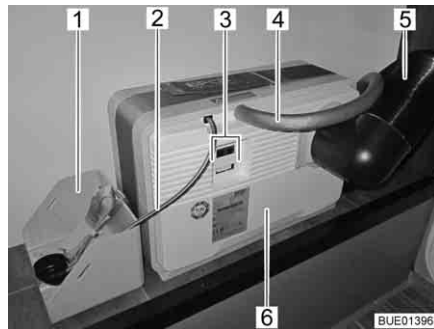

Fig. 135 Fuel cell with tank cartridge

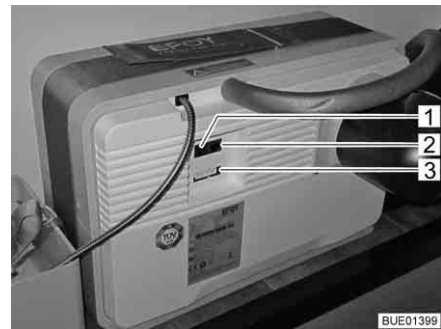

Fig. 136 Connector panel of the fuel cell

The fuel cell consists of several components that are installed in the rear storage space (Fig. 135) and of an operating unit (Fig. 137) in the living area.

The following components are on the fuel cell (Fig. 135,6):

- The connector for the air discharge hose (Fig. 135,4) or the filling hole for the service fluid
- the off-heat tube (Fig. 135,5)
- electrical connections (Fig. 135,3) with data interface (Fig. 136,2), device connection (Fig. 136,3) and connection for the operating panel (Fig. 136,1)

A tank cartridge belongs to the fuel cell (Fig. 135,6). It is connected to the fuel cell via a tank connection (Fig. 135,2).

The tank cartridge is firmly fixed in the tank cartridge holder (Fig. 135,1).

The fuel cell automatically charges the living area batteries if their voltage falls below 12,3 V and if the fuel cell is switched on using the On/Off key (Fig. 137,8).

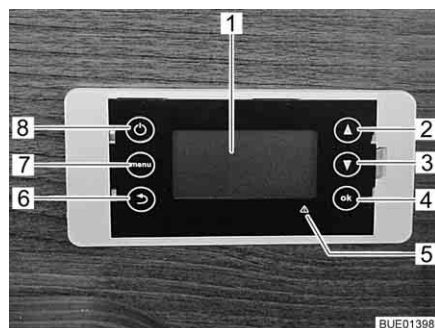

Fig. 137 Operating unit fuel cell

- 1 Display
- 2 Scroll upwards through menu
- 3 Scroll downwards through menu
- 4 Confirmation/OK
- 5 Fault display (red LED)
- 6 Back
- 7 Menu
- 8 On/Off

Operating unit

The display (Fig. 137,1) of the operating unit has four lines.

The first line displays the selected operating mode:

- Automatic
- On
- Off

The second line displays the current operating status:

- Standby
- Charging mode
- Shutdown procedure
- Battery protection
- Antifreeze

The other two rows show information such as battery voltage, charging current and filling level of the tank cartridge.

The main menu can be accessed with the menu key (Fig. 137,7):

- Operating mode
- Fuel cartridge
- System information
- Language
- System reset

In the event of faults, the red fault indicator (Fig. 137,5) lights up and a message appears on the display. The message consists of an error code and information on how to rectify the fault.

After rectifying the fault, carry out a system reset.

If the tank cartridge needs to be changed or service fluid replenished, this will also be indicated.

- Switching on:*
- Press the On/Off key.
 - Select the desired operating mode and confirm with "OK".

- Switching off:*
- Press the On/Off key.
 - Select the "Manual Off" operating mode and confirm with "OK". The fuel cell switches itself off in a controlled way. This procedure can take a while. "Shutdown procedure" appears on the display.

Automatic mode Automatic mode starts as soon as the device is attached to the power supply. The device monitors the battery voltage independently.

The fuel cell switches itself on automatically when the battery voltage falls below 12.3 Volts. The battery is then charged to reach the switch-off threshold (14.2 Volts).

When started, the device runs through a start phase lasting up to 20 minutes. Only after this period is its full nominal power reached.

Battery protection This function prevents the battery from discharging completely when the operating mode is set to "Off".

Battery protection is activated automatically when the battery voltage falls below 11.2 Volts for more than 15 minutes. The "Battery protection" charge mode ends when the voltage of 12.8 Volts is reached.

Frost protection This mode is triggered automatically as soon as the temperature falls below 3 °C. It prevents the device from freezing.



- ▶ Observe the safety instructions for methanol.

Replacing the tank cartridge:

- Unscrew the tank cartridge connection from the empty tank cartridge.
- Loosen the securing belt on the tank cartridge.
- Remove empty tank cartridge from the tank cartridge holder.
- After use, firmly close the cap of the tank cartridge.
- Insert a new, sealed original tank cartridge into the tank cartridge holder.
- Secure the tank cartridge with the securing belt.
- Open cap and keep safe.

- Screw tank cartridge connection onto the new tank cartridge.
- In the "Main Menu > Fuel Cartridge" menu, specify the tank cartridge size used and confirm with "OK".

8.9 Solar installation (special equipment)



- ▷ Protect the solar collectors (solar module) against mechanical overload.



- ▷ The solar installation supplies the most current under optimal sunlight conditions.
- ▷ Provide the solar collectors (solar module) open access to sunlight.
- ▷ Sunlight is greater in the open air than under trees and bridges.
- ▷ Tarpaulins block out sunlight.
- ▷ Always keep collector surfaces free of contamination.
- ▷ Also read the manufacturer's instruction manual.

The solar installation provides an environmentally compatible power supply independent of the mains. It converts energy from sunlight into electric current. The solar installation supplies additional current for the battery and appliances.

The solar charge regulator has an integrated overload protection and back flow valve. The charging current is automatically reduced or the solar collectors (solar modules) are switched off if the solar power is not sufficient (e.g. at night).

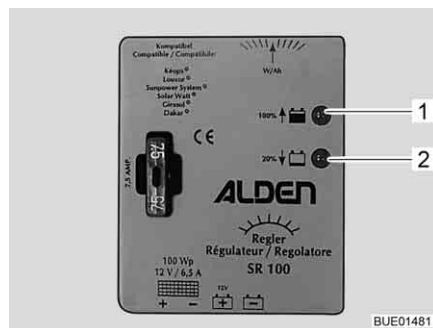

Fig. 138 100 W solar charge regulator

100 W solar installation

Two LEDs (Fig. 138,1 and 2) indicate the current operating status by means of different brightness. The higher the charge status of the battery, the brighter the LED lights "100 % ↑" (Fig. 138,1) and, the lower the charge status of the battery, the lower the LED lights "20 % ↓" (Fig. 138,2).

LED	Status	Signification
100 % ↑	Off	Solar power insufficient
20 % ↓	Off	
100 % ↑	Lights	Battery being charged
20 % ↓	Lights	
100 % ↑	Lights brightly	Charging current limited to trickle charging current
20 % ↓	Glows weakly	

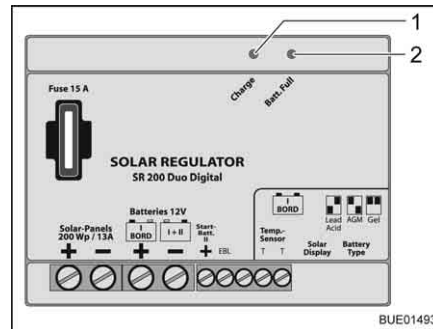

Fig. 139 140/200 W solar charge regulator

140/200 W solar installation

Two LEDs (Fig. 139,1 and 2) indicate the current operating status by means of different brightness. The higher the charge status of the battery, the brighter the "Batt. Full" LED (Fig. 139,2) lights up and the weaker the "Charge" LED lights up (Fig. 139,1).

LED	Status	Signification
Batt. Full	Off	Solar power insufficient
Charge	Off	
Batt. Full	Lights	Battery being charged
Charge	Lights	
Batt. Full	Lights brightly	Charging current limited to trickle charging current
Charge	Glows weakly	

8.10 230 V power supply



- ▶ Only allow qualified personnel to work on the electrical system.
- ▶ Have the vehicle's electrical system checked by a qualified electrician at least once every 3 years. If the vehicle is used frequently, an annual check is recommended.

The 230 V power supply provides electricity for:

- sockets with earth contact for appliances with maximum 16 A
- refrigerator
- transformer/rectifier
- an auxiliary charging unit
- air conditioning unit

The electrical appliances connected to the 12 V power supply of the living area are supplied with voltage by the living area battery.

Connect the vehicle to an external 230 V power supply system as often as possible. The charger module in the transformer/rectifier automatically charges the living area battery. In addition to this, the starter battery is charged with a float charge of approx. 2 A.

Depending on the equipment, the air conditioning unit and other optional devices are fuse-protected by their own safety cut-out (16 A).

8.10.1 230 V connection



- ▷ Overvoltage can damage connected devices. Overvoltage can be caused by lightning, irregular voltage sources (e.g. petrol-operated generators) or power connections on ferries for example.

Requirements concerning the 230 V connection

- The connection cable, the plug connectors at the point of supply and the plug connector to the vehicle must comply with IEC 60309. The standard designation for the plug connectors is "CEE blue".
- Use H07RN-F rubber sheathed cable with a minimum cable cross-section of 2.5 mm² and a maximum length of 25 m.
- Earth contact connectors (safety) are not permitted. The interconnection of CEE/safety adapters is also prohibited.

8.10.2 Connecting 230 V power supply



- ▶ The external 230 V power supply must be protected by fuse with a fault current protection switch (FI-switch, 30 mA).
- ▶ To prevent overheating, the cable must be fully uncoiled from the cable reel.
- ▶ In case of doubt or if the 230 V supply is not available or is faulty, contact the operator of the power supply device.



- ▷ The 230 V connection in the vehicle is equipped with a fault current protection switch (FI-switch).
- ▷ For the connection points on camp sites (camping distributors) fault current protection switches (FI-switches, 30 mA) are obligatory.

The vehicle can be connected to an external 230 V power supply.



Fig. 140 230 V fuse box with safety cut-out and FI-switch



Fig. 141 230 V connection on vehicle

Connecting the vehicle:

- Check whether the power supply device is suitable regarding connection, voltage, frequency and current.
- Check whether the cables and connections are suitable.
- Check the plug connectors and cables for visible damage.
- Switch off the safety cut-out (Fig. 140,1 and 2) in the fuse box (Fig. 140,3).
- Open the cover of the 230 V connection on the vehicle (Fig. 141) and insert the plug connector. Ensure that the detent of the spring-mounted pivoting cover is engaged in position.

- Plug the connector of the connecting cable into the socket of the power supply device. Ensure that the detent of the spring-mounted pivoting cover is engaged in position.
- Switch on the safety cut-out in the fuse box.

Checking the fault current protection switch:

- When the vehicle is connected to the 230 V supply, press the check button (Fig. 140,5) of the fault current protection switch (FI-switch) (Fig. 140,4) in the fuse box (Fig. 140,3). The fault current protection switch must trip.
- Switch the fault current protection switch back on again.

Unplugging the connection:

- Switch off the safety cut-outs (Fig. 140,1 and 2) in the fuse box (Fig. 140,3).
- Loosen the detent on the power supply device and unplug the connection cable from the socket.
- Loosen the detent on the vehicle, unplug the plug connector and close the cover of the 230 V connection.

8.11 Fuses



- ▶ Only replace defective fuses when the cause of the defect is known and has been remedied.
- ▶ Replace defective fuses only after the power supply has been turned off.
- ▶ Never bridge or repair fuses.
- ▶ Only replace faulty fuses with a new fuse with the same rating.

8.11.1 12 V fuses

The appliances connected to the 12 V power supply in the living area are fused individually. The fuses can be accessed in the driver's cabin, on the batteries, on or next to the transformer and on the appliances.

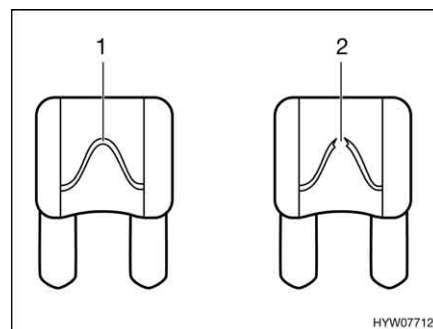

- 1 Unbroken fuse element
- 2 Broken fuse element

Fig. 142 12 V fuse

An intact 12 V fuse can be detected by the unbroken fuse element (Fig. 142,1). If the fuse element is broken (Fig. 142,2), change the fuse.

Before changing fuses, take the function, value and colour of the relevant fuses from the following specifications. When changing fuses, only use flat fuses with the values shown below.

Fuses on the starter battery

The fuses are installed in the vicinity of the starter battery. The starter battery is on the floor between the seats in the driver's cabin and can be accessed under a cover.

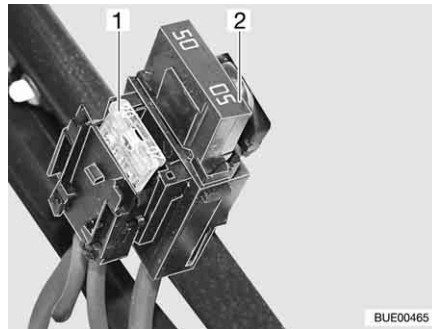

- 1 Flat fuse 20 A/yellow (for the refrigerator)
- 2 Jumbo flat fuse 50 A/red

Fig. 143 Fuses on the starter battery

Fuses on the living area battery

The fuses are fitted next to the living area battery.

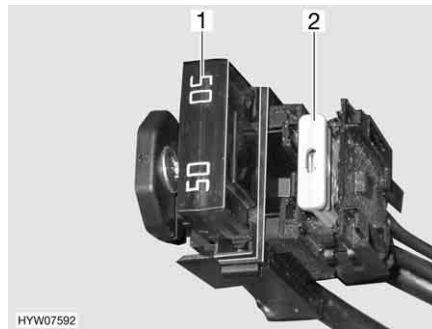

- 1 Jumbo flat fuse 50 A/red (for the transformer/rectifier)
- 2 Flat fuse 2 A/grey (for battery sensor, living area battery)

Fig. 144 Fuses on the living area battery

Fuses on the relay box AD01

A relay box (AD01) is installed in one of the two seat consoles. The relay box helps generate the signals for the chassis lighting not provided by the base vehicle. The relay box can be used anywhere.

The circuit used by us can vary from the circuit provided by the manufacturer. Consequently, the circuit can also vary from the display on the relay box type plate, which the manufacturer affixed.

FuNo	Function	Value/colour
B2	Cl. 15 (ignition on)	15 A blue
B3	Cl. 30 (constant positive)	15 A blue
B5	Signal D+	Internal Polyswitch (2 A)
B6	Spare	15 A blue
B7	Front side marker lights (white/red)	5 A light brown

**Fuses on the
transformer/rectifier
(EBL 99)**

Function	Value/colour
Internal charger module	20 A yellow
Compressor/AES refrigerator	20 A yellow
Heater	10 A red
Basic light/electrically operated entrance step/radio	25 A white
Spare 4	25 A white
Spare 3	25 A white
Spare 2	15 A blue
Spare 1	15 A blue
Solar	15 A blue
Spare 5	15 A blue
Spare 6	15 A blue
Auxiliary charging unit	20 A yellow
Circuit 1	10 A red
Circuit 2	10 A red
TV	10 A red
Water pump	5 A light brown

**Fuses on the
transformer/rectifier
(EBL 220)**

Function	Value/colour
Auxiliary charging unit 2	25 A white
Auxiliary charging unit 1	25 A white
Internal charger module	20 A yellow
Spare 2	15 A blue
Pump (for water)	7.5 A brown
Circuit 3	10 A red
Circuit 2	15 A blue
Circuit 1	15 A blue
Spare 1	15 A blue
Circuit 5	15 A blue
Refrigerator	15 A blue
Heater	10 A red
Circuit 4	15 A blue
Refrigerator control	2 A grey
Awning light	5 A light brown
Antenna	10 A red
TV	10 A red
Solar	15 A blue
Step	15 A blue

Function	Value/colour
Awning	10 A red
Gas alarm	2 A grey
Pull-down bed	25 A white

Fuses for pneumatic spring

The fuses are installed in the base vehicle's fuse box.

Function	Value/colour
Control	7.5 A brown
Compressor	40 A green

Fuse for the Thetford toilet (swivel toilet)

The fuse is located in the locker wall of the Thetford cassette.

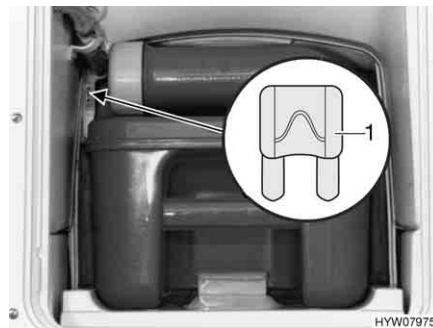

1 Flat fuse 3 A/purple

Fig. 145 Fuse for the Thetford toilet

Changing:

- Open the flap for the Thetford cassette on the outside of the vehicle.
- Pull out the Thetford cassette completely.
- Replace fuse (Fig. 145,1).

Fuse for the Thetford toilet (fixed seat)

The fuse is located in the locker wall of the Thetford cassette.



1 Flat fuse 3 A/purple

Fig. 146 Fuse for the Thetford toilet

Changing:

- Open the flap for the Thetford cassette on the outside of the vehicle.
- Remove the Thetford cassette and swing out the flap in the housing panel.
- Replace fuse (Fig. 146,1).

Fuses for heater for waste water pipes

The fuses are located on the regulator (Fig. 147,1).



Fig. 147 Heater regulation for waste water pipes

Changing:

- Switch the heater off.
- Replace fuse (Fig. 147,2).

Fuel cell fuse (special equipment)

Two fuses are located next to the living area battery.

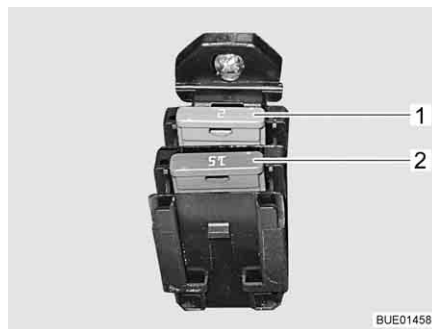

Fig. 148 Fuses for fuel cell

- 1 Flat fuse 2 A/grey
- 2 Flat fuse 15 A/blue

Fuse on the solar charge regulator (special equipment)

The fuse is located on the solar charge regulator.

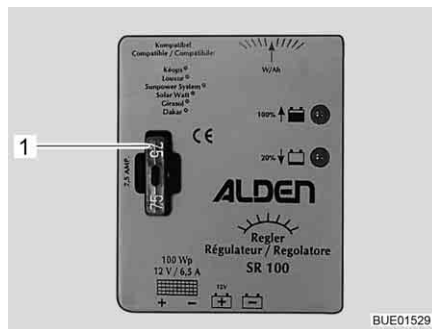

Fig. 149 Fuse of the 100 W solar charge regulator

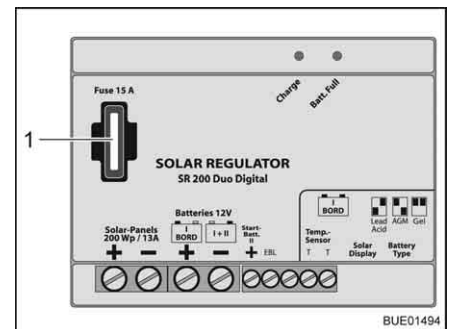

Fig. 150 Fuse of the 140/200 W solar charge regulator

Replacing the fuse on the 100 W solar charge regulator:

- Disconnect all 12 V appliances.
- Replace flat fuse 5 A/light brown (Fig. 149,1).

Replacing the fuse on the 140/200 W solar charge regulator:

- Disconnect all 12 V appliances.
- Replace flat fuse 15 A/blue (Fig. 150,1).

8.11.2 230 V fuse



- ▷ Check the fault current protection switch for each connection to the 230 V power supply, at least once every 6 months.



Fig. 151 230 V fuse box with safety cut-out and FI-switch

A fault current protection switch (FI-switch) (Fig. 151,4) in the fuse box (Fig. 151,3) protects the complete vehicle from fault current (0.03 A).

The downstream safety cut-out (10 A) (Fig. 151,2) secures the 230 V sockets, the power supply unit, the auxiliary charging unit and the refrigerator.

For vehicles with special equipment, e.g. air conditioning unit, an additional safety cut-out (16 A) (Fig. 151,1) secures the device.

Position See chapter 16.

Checking the fault current protection switch:

- When the vehicle is connected to the 230 V power supply, press the test button (Fig. 151,5). The fault current protection switch (FI-switch) must be activated.

8.12 External socket (special equipment)

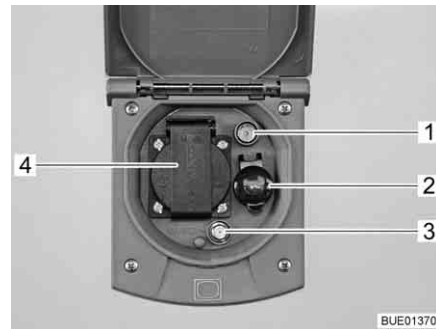

- 1 TV socket
- 2 12 V socket
- 3 SAT socket
- 4 230 V socket

Fig. 152 External socket

The 230 V socket and the 12 V socket can be used to power electrical devices in the awning.

Connection possibilities

TV socket and SAT socket offer various possibilities for TV operation:

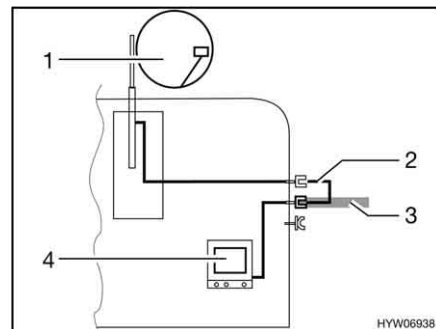

Fig. 153 TV inside the vehicle

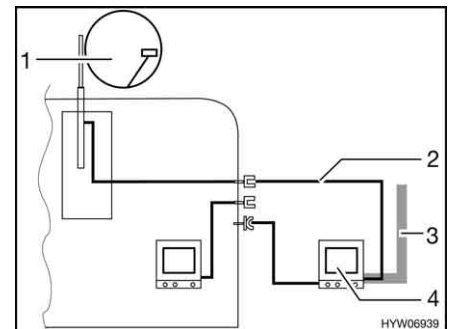
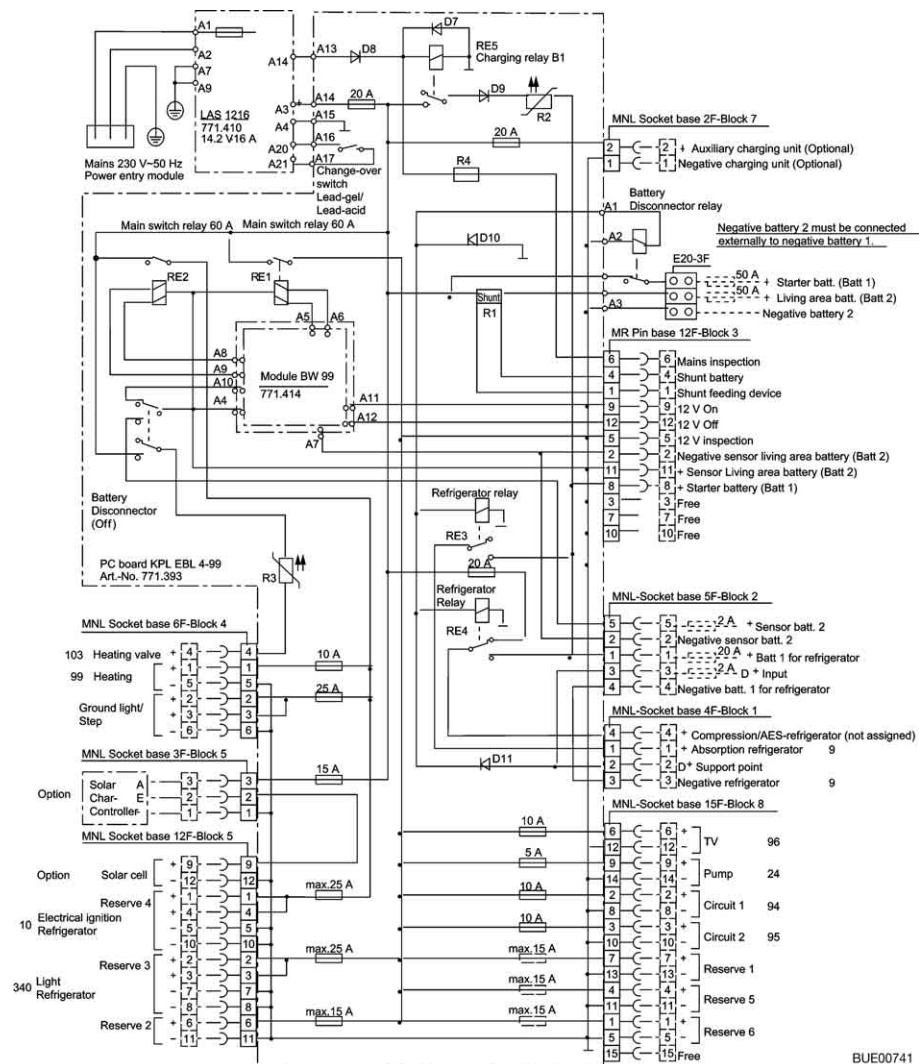

Fig. 154 TV in the awning

- TV inside the vehicle (Fig. 153,4): Connection to roof antenna (Fig. 153,1) with connection cable (Fig. 153,2)
- TV inside the vehicle (Fig. 153,4): Connection to external antenna (Fig. 153,3)
- TV inside the awning (Fig. 154,4): Connection to roof antenna (Fig. 154,1) with connection cable (Fig. 154,2)
- TV inside the awning (Fig. 154,4): Connection to external antenna (Fig. 154,3)

8.13 Circuit diagrams

8.13.1 Circuit diagrams, interior



BUE00741

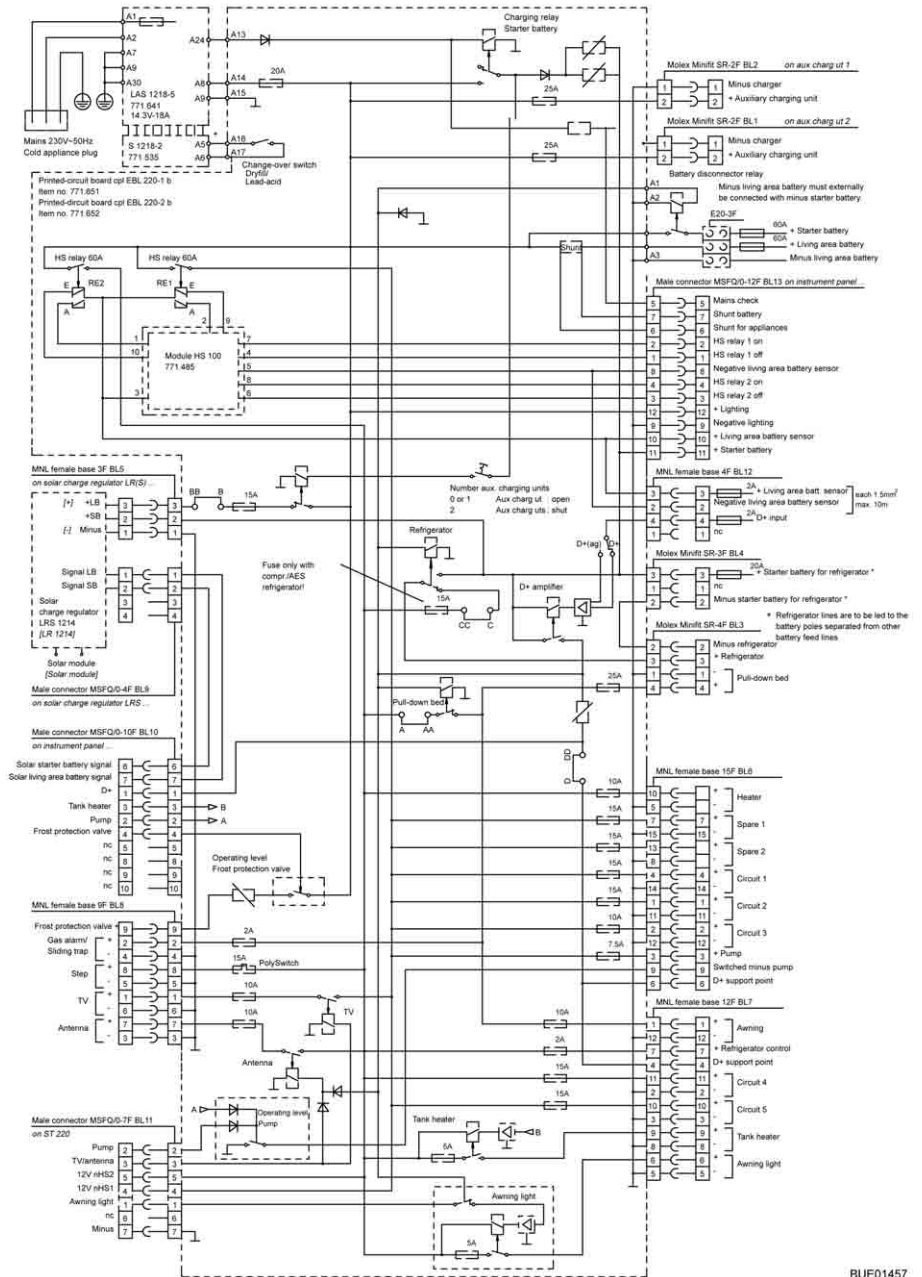

Fig. 156 Circuit diagram, interior (EBL 220)

BUE01457

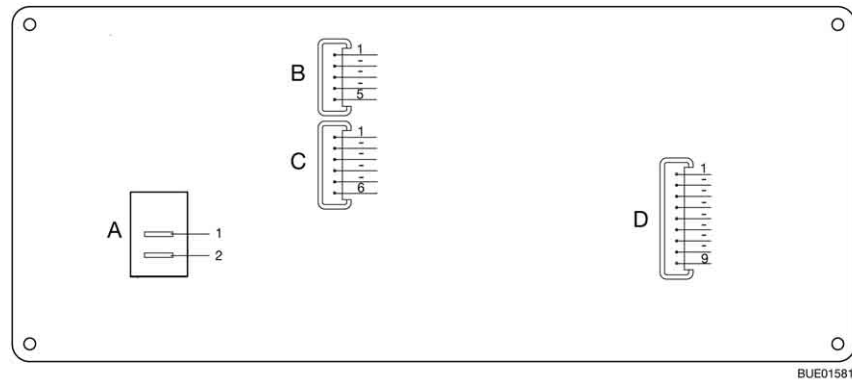

Fig. 157 Connection diagram, panel (IT 96-2)

A	2 x AMP flat pins 4.8 x 0.8
1	+ 12 V
2	Pump
B	Lumberg MSFQ 5-pin
1	Full
2	3/4
3	1/2
4	1/4
5	Base waste water tank
C	Lumberg MSFQ 6-pin
1	Full
2	3/4
3	1/2
4	1/4
5	Base water tank
6	n. c.
D	Lumberg MSFQ 9-pin
1	12 V indicator
2	12 V main switch off
3	12 V main switch on
4	+ Starter battery 12 V
5	+ Living area battery sensor
6	Negative living area battery sensor
7	230 V indicator
8	n. c.
9	n. c.

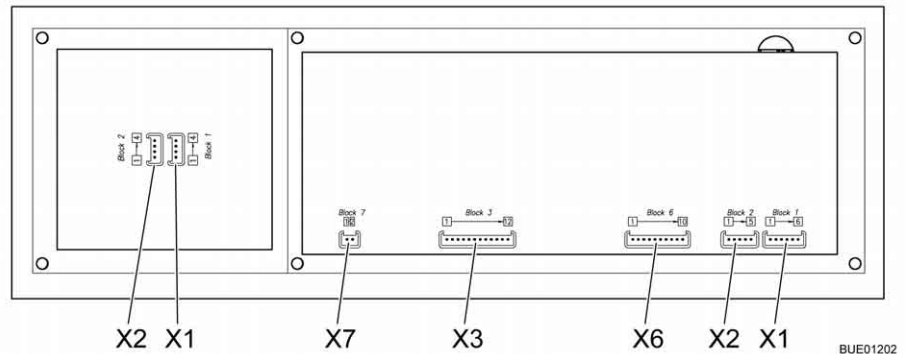

Fig. 158 Block diagram, panel (LT 510)

X1	Lumberg MSFQ 6-pin
1	Full
2	3/4
3	1/2
4	1/4
5	Base water tank
6	n. c.
X2	Lumberg MSFQ 5-pin
1	Full
2	3/4
3	1/2
4	1/4
5	Base waste water tank
X3	Lumberg MSFQ 12-pin
1	Main switch relay 1 off
2	Main switch relay 1 on
3	Main switch relay 2 off
4	Main switch relay 2 on
5	Mains signal
6	Shunt for appliances
7	Shunt battery
8	Negative living area battery sensor
9	n. c.
10	+ Living area battery sensor
11	+ Starter battery 12 V
12	+ Lighting

X6	Lumberg MSFQ 10-pin
1	D+
2	Pump
3	Tank heater
4	Anti-freeze
5	n. c.
6	Solar starter battery
7	Solar living area battery
8	n. c.
9	n. c.
10	n. c.
X7	Lumberg MSFQ 2-pin
1	KTY Pin 1
2	KTY Pin 2
X1	Lumberg MSFQ 4-pin
1	ADI1
2	ADI2
3	+12 V
4	GND
X2	Lumberg MSFQ 4-pin
1	ADI1
2	ADI2
3	+12 V
4	GND

8.13.2 Circuit diagram, exterior

Fiat

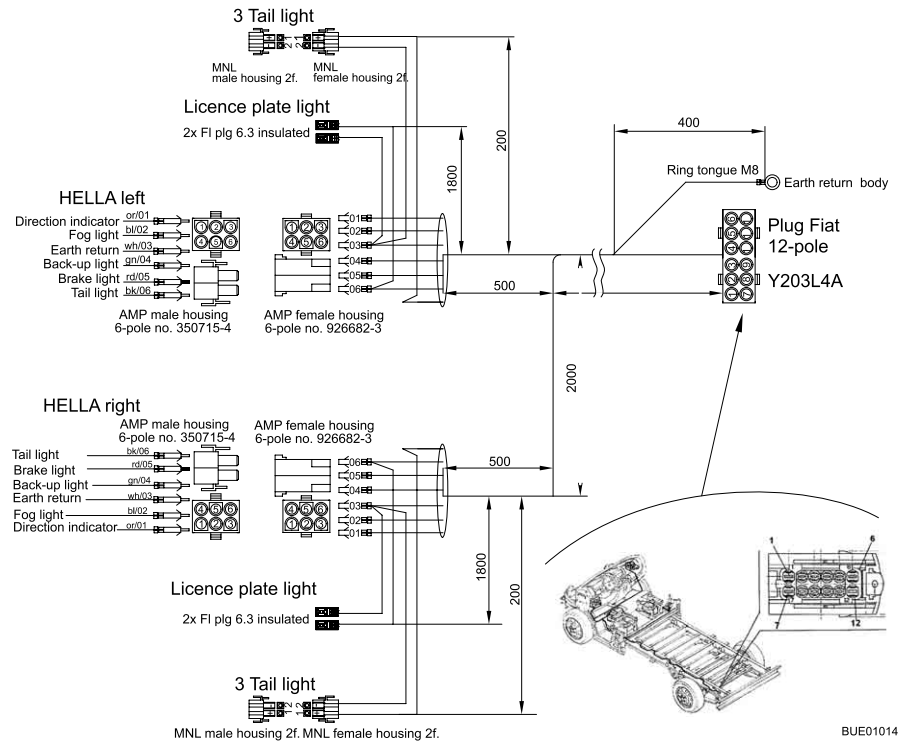

Fig. 159 Circuit diagram, exterior

Left side

Bürstner colours	Connection
Grey	Left direction indicator
Blue	Fog tail light
White	Earth return
Green	Back-up light
Red	Brake light
Black	Left rear light

Right side

Grey	Right direction indicator
Blue	Fog tail light
White	Earth return
Green	Back-up light
Red	Brake light
Black	Right rear light

Chapter overview

This chapter contains instructions regarding the appliances of the vehicle.

The instructions refer exclusively to the operation of the appliances.

Further information about the appliances can be found in the instruction manuals for the appliances, included separately with the vehicle.

The instructions address the following topics:

- heater
- air conditioning unit
- boiler
- gas cooker
- gas oven
- microwave oven
- extractor hood
- refrigerator

9.1 General



- ▷ The heat exchanger of the Truma hot-air heater has to be replaced after 30 years. The heat exchanger of the Alde hot-water heater has to be replaced after 10 years. Only the manufacturer of the heater or an authorised specialist workshop is allowed to replace the heat exchanger. The operator of the heater must see to it that the parts are replaced.
- ▷ For safety reasons, spare parts for pieces of heating appliances must correspond with manufacturer's instructions and be permitted by the manufacturer as a spare part. These spare parts may only be fitted by the manufacturer or an authorised specialist workshop.



- ▷ Further information can be obtained in the instruction manual for the respective appliance.

The heater, air conditioning unit, boiler, cooker and refrigerator are fitted depending on the model of the vehicle.

In this instruction manual a description is given only for the operation of the appliances and their particular features.

To operate gas appliances, first open the regulator tap on the gas bottle and the gas isolator tap corresponding to the appliance.

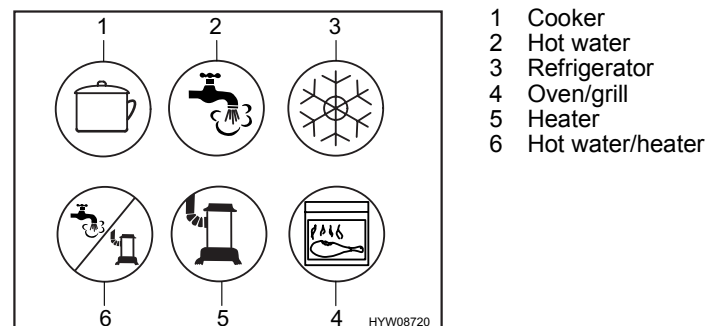

Fig. 160 Symbols for the gas isolator taps

9.2 Heater



- ▶ Never let gas escape unburned due to danger of explosion.
- ▶ Never run the heater in gas operation when refuelling, on ferries or in the garage. Danger of explosion!
- ▶ Never operate the heater in gas operation in closed spaces (e.g. garages). Danger of poisoning and suffocation!
- ▶ The waste gas vent may neither be closed nor blocked.
- ▶ Do not use the space behind the heater as a storage compartment.

Initial start-up

When lighting the heater for the first time a small amount of smoke and odour will occur. Immediately set the operating switch of the heater to its highest position. Open doors and windows and ventilate well. Smoke and odour will disappear by themselves after a while.

9.2.1 Models with waste gas vent on the right-hand side of the vehicle



- ▶ If the awning is put up and the heater is running in gas operation, exhaust gases from the heater can escape into the awning area. Danger of suffocation! Make sure the area is sufficiently ventilated.

9.2.2 To heat properly



Fig. 161 Air outlet nozzle of the hot air distribution

Hot air distribution

Several air outlet nozzles (Fig. 161) are built into the vehicle. Pipes conduct the warm air to the air outlet nozzles. Turn the air outlet nozzles in a suitable position so the air can escape as required. To avoid draft close the air outlet nozzles on the dashboard and set the air distribution of the base vehicle to air circulation.

Adjusting the air outlet nozzles

- Fully open: Full hot air stream
- Half or partially open: Reduced hot air stream

When five air outlet nozzles are completely opened, less warm air escapes through each nozzle. However, if only three air outlet nozzles are opened, more warm air flows out of each nozzle.

9.2.3 Truma Combi hot-air heater



- ▷ If there is a risk of frost and the heater is not in operation, empty the boiler.
- ▷ The circulation fan of the hot-air heater automatically goes on when the hot-air heater is activated and is automatically switched off and on during operation by means of a thermostat control. This puts an immense strain on the living area battery, if the vehicle is connected to an external 230 V power supply. Take into consideration that the living area battery only has limited reserves of energy.

Depending on the equipment, different heaters are installed in the vehicles. The heaters differ with regard to the energy type with which they can be operated.

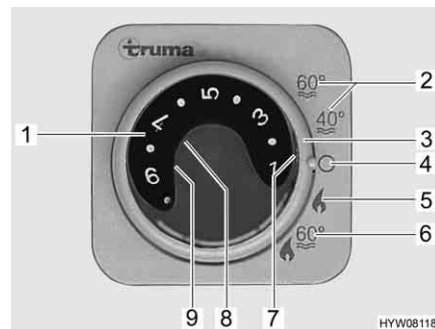

- 1 Temperature control knob
- 2 Summer operation water temperature 40 °C or 60 °C
- 3 Rotary switch
- 4 Off
- 5 Winter operation "Heater without boiler"
- 6 Winter operation "Heater and boiler"
- 7 Green indicator lamp "Heating operation"
- 8 Red indicator lamp "Fault"
- 9 Yellow indicator lamp "Boiler heating-up phase"

Fig. 162 Operating unit for heater/boiler

Operating modes

All heaters have two operating modes:

- Winter operation
- Summer operation

It is only possible to heat the vehicle in the "Winter" operating mode. With the "Summer" operating mode only water in the boiler is heated. It is not possible to heat the vehicle in this operating mode.

Selecting operating mode:

- Set the operating mode using the rotary switch (Fig. 162,3).

The power supply of the heater cannot be interrupted by means of the 12 V main switch.

Variant: Heater with gas operation

The heater is operated exclusively with gas.

Winter operation

The heater selects the necessary burner setting according to the required room temperature. When the required room temperature is reached, the burner is switched off. In "Heater and boiler" operating mode (Fig. 162,6) water in the boiler is also heated. In the operating mode "Heater without boiler" (Fig. 162,5) the heater can be operated with an empty boiler.

Switching on:

- Open the regulator tap on the gas bottle and the gas isolator tap "Heater/boiler".
- Turn the temperature control knob (Fig. 162,1) on the operating unit to the desired heating level.
- Set rotary switch (Fig. 162,3) to winter operation "Heater without boiler" (Fig. 162,5) or to winter operation "Heater and boiler" (Fig. 162,6).

Green indicator lamp (Fig. 162,7) is on.

The circulation fan automatically switches on when the heater is activated.

- Switching off:*
- Set the rotary switch (Fig. 162,3) to "O" (Fig. 162,4).
 - Close the gas isolator tap "Heater/boiler" and the regulator tap on the gas bottle.

After switching off the heater, the circulation fan may still run for a moment to use up the residual heat.

Summer operation

It is not possible to heat the vehicle in "Summer" operating mode. In "Summer" operating mode, only the water in the boiler is heated.

Variant: Heater with gas and 230 V electrical operation



- ▷ 230 V electrical operation is only possible when the vehicle is connected to the 230 V power supply.
- ▷ Select the output level for 230 V electrical operation so that it corresponds to the fuse protection of the 230 V connection (900 W for 3.9 A fuse, 1800 W for 7.8 A fuse).
- ▷ When the heater on the operating unit is set to summer operation and the energy selector switch is set to mixed operation, the heater will only heat the water in the boiler. For this, the heater only runs in 230 V operation. The gas burner is not switched on. The vehicle is not heated.

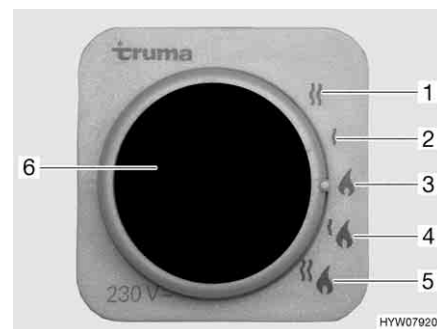

- 1 230 V electrical operation (1800 W)
- 2 230 V electrical operation (900 W)
- 3 Gas operation
- 4 Gas and 230 V electrical operation (900 W)
- 5 Gas and 230 V electrical operation (1800 W)
- 6 Yellow indicator lamp "230 V electrical operation"

Fig. 163 Energy selector switch for heater/boiler

The heater can be operated with different types of energy:

- Gas operation (Fig. 163,3)
- 230 V electrical operation with the output levels 900 W (Fig. 163,2) or 1800 W (Fig. 163,1)
- Gas and 230 V electrical operation (mixed operation) with the output levels 900 W (Fig. 163,4) or 1800 W (Fig. 163,5)

The combination gas operation and 230 V electrical operation reduces the heating-up time of the vehicle (only possible when the heater on the operating unit (Fig. 162) is set to winter operation).

When 230 V electrical operation is selected, the yellow indicator lamp (Fig. 163,6) illuminates.



- ▷ Further information can be obtained in the manufacturer's instruction manual.
- ▷ For further information about the use of the boiler see section "Boiler".

9.2.4 Hot-air heater with CP plus digital operating unit



- ▷ If there is a risk of frost and the heater is not in operation, empty the boiler.
- ▷ The circulation fan is automatically switched on when the hot-air heater is activated, and it stays on. This puts an immense strain on the living area battery, if the vehicle is not connected to an external 230 V power supply. Take into consideration that the living area battery only has limited reserves of energy.



- ▷ The hot-air heater can even run on an empty boiler.
- ▷ If the power supply to the heater was interrupted, the time must be reset.

Operating unit

The operating unit is divided into two sections:

- Display
- Control buttons



- 1 Display
- 2 Rotary push button
- 3 Back button

Fig. 164 Operating unit

After being switched on, the most recently set values/operating parameters are activated.

If no button is pressed, the operating unit switches to stand-by mode after a few minutes.

If the time is set, the display in stand-by mode alternates between the time and the room temperature set.

After being switched off, the display in the control unit may remain active for several minutes since the heater is still running.

Control buttons

The control buttons have the following functions:

Button	Button operation	Function
Rotary push button (Fig. 164,2)	Turn to the right	Menu is run through from left to right
		Values are increased
	Turn to the left	Menu is run through from right to left
		Values are decreased
Press briefly	Press (3 seconds)	Selected value is saved
		Menu item is selected for changing values (selected menu item flashes)
Back button (Fig. 164,3)	Press	Return from a menu item without saving values

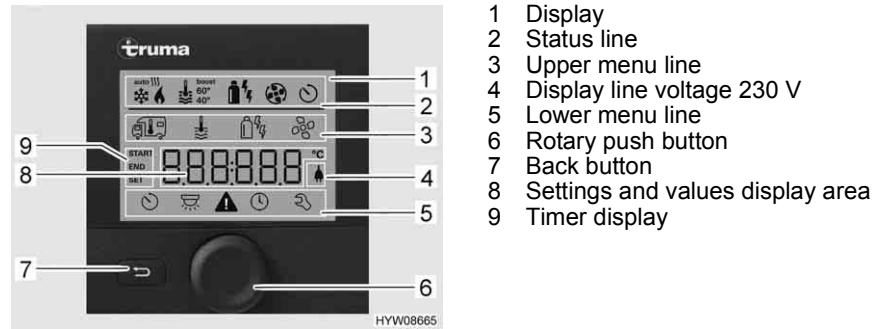

Fig. 165 Operating unit with displays

Display

The display is divided into four sections:

- Status line (Fig. 165,2)
- Upper menu line (Fig. 165,3)
- Display area (Fig. 165,8)
- Lower menu line (Fig. 165,5)

Switching operating unit on/off:



- Press and hold the rotary push button (Fig. 165,6) for approx. 3 seconds. Both menu lines (Fig. 165,3 and Fig. 165,5) are displayed. The first symbol flashes.
- ▷ Switching the operating mode on/off means switching between stand-by and setting mode. In stand-by mode, the display alternates between the room temperature and the time that have been set.

Carrying out settings:

- Turn rotary push button (Fig. 165,6) until the required menu symbol flashes.
- Press rotary push button.
- Turn rotary push button until the required value is displayed.
- Press rotary push button to save the value set. If you do not wish to change the value originally set: Press back button (Fig. 165,7).

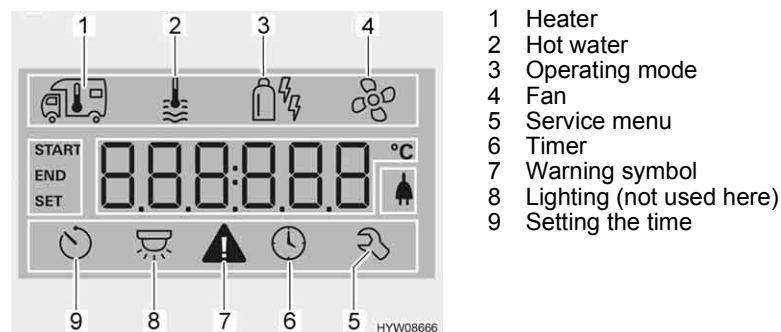

Fig. 166 Display

Switching on the heater:

- Open the regulator tap on the gas bottle and the gas isolator tap "Heater/boiler".
- Turn rotary push button (Fig. 165,6) until the heater menu symbol (Fig. 166,1) flashes.
- Press rotary push button.
- Turn rotary push button until required value is displayed.
- Press rotary push button to save the value set. The symbol in the status line (Fig. 165,2) flashes until the room temperature set is reached. If you do not wish to change the value originally set: Press back button (Fig. 165,7).

Switching the heater off:







- Turn temperature value back until OFF is displayed. Press rotary push button to save.
- ▷ The required room temperature can also be changed in stand-by mode by turning the rotary push button.

Obtaining hot water

The operation of the hot water supply is described in the "Boiler" section.

Selecting operating mode:



- Turn rotary push button (Fig. 165,6) until the menu symbol operating mode (Fig. 166,3) flashes.
- Press rotary push button.
- Turn rotary push button until the desired operating mode is displayed:
 -  Gas operation
 -  Electrical operation (900 W)
 -  Electrical operation (1800 W)
 -  Gas and electrical operation (900 W)
 -  Gas and electrical operation (1800 W)
- Press the rotary push button to save the set operating mode. To revert to the original setting: Press back button (Fig. 165,7).
- ▷ 230 V electrical operation is only possible when the vehicle is connected to the 230 V power supply.
- ▷ Select the output level for 230 V electrical operation so that it corresponds to the fuse protection of the 230 V connection (900 W for 3.9 A fuse, 1800 W for 7.8 A fuse).

The combination of gas operation and 230 V electrical operation shortens the time required to heat up the vehicle.

Setting the fan:

- Turn rotary push button (Fig. 165,6) until the fan menu symbol (Fig. 166,4) flashes.
- Press rotary push button.
- Turn rotary push button until the required value is displayed:
 - OFF: Fan is switched off.
 - VENT: Air circulation
 - ECO: Low fan setting
 - HIGH: High fan setting
 - BOOST: Fast room heating. Boost is available if the current room temperature is at least 10 °C below the selected room temperature.
- Press rotary push button to save the value set. If you do not wish to change the value originally set: Press back button (Fig. 165,7).

Setting the timer:

- Turn rotary push button (Fig. 165,6) until the timer menu symbol (Fig. 166,6) flashes.
- Press rotary push button. The start time is displayed and the hour display flashes.
- Turn rotary push button until the hour of the selected start time is displayed.
- Press rotary push button. The minute display flashes.
- Turn rotary push button until the minute of the selected start time is displayed.

- Press rotary push button.
- Proceed in the same way to set the switch-off time, the required room temperature, the hot water setting and the fan setting.
- Press rotary push button. The timer is activated. The timer symbol (Fig. 166,6) flashes when the timer is programmed and active.



- ▷ The service menu contains items that generally only need to be set once (language, background brightness, calibration), as well as information for service centres (version numbers).

Fault display

The warning symbol (Fig. 166,7) flashes in the event of a warning. The heater continues to operate. In the event of only a temporary fault, the warning symbol goes out automatically.

In the event of a warning, the control unit displays the error code for the fault. The heater is switched off. Press rotary push button to restart the heater.



- ▷ Further information can be obtained in the manufacturer's instruction manual.
- ▷ For further information about the use of the boiler see section "Boiler".

9.2.5 Aide hot-water heater (only Argos 747-2)



- ▷ Never run hot-water heater without heating fluid. Observe notes in chapter 12.
- ▷ Never drill holes in the floor. This might damage the hot-water pipes.



- ▷ The circulating pump must always be turned on when the hot-water heater is in operation.
- ▷ We recommend to bleed the heating system after the initial heater operation and to check the glycol content. Observe notes in chapter 12.
- ▷ When the heater is turned on, it starts with the last settings used.
- ▷ For further information, see the separate manufacturer's instruction manual and observe the maintenance instructions found in chapter 12.
- ▷ For further information about the use of the boiler see section "Boiler".

The hot-water heater is installed at the bottom of the wardrobe or under the beds.

Operating unit

The operating unit is divided into two sections:

- Display (touch screen)
- Control buttons



- 1 Display (touch screen)
- 2 "Menu" button
- 3 "On/Off" button

Fig. 167 Operating unit for hot-water heater



- ▷ When no button is pressed, the operating unit automatically switches to home position after two minutes.
- ▷ Changes to the settings are saved automatically after 10 seconds.

Control buttons

The control buttons have the following functions:

Pos. in Fig. 167	Button	Function
2	MENU	Open adjustment menu
3		Activate heating

Display

The display (Fig. 167, 1) is designed as a touch screen. Touching the symbols calls up the relevant function.



Fig. 168 Start screen

Start screen

The Start screen appears on the display after the heater is switched on. The Start screen contains the following information:







Symbol	Signification
	This symbol appears when the circulating pump is activated
	This symbol appears when a switching facility for gas cylinders is activated
	This symbol appears when a voltage of 230 V is present at the heater
	The internal temperature is displayed next to this symbol
	The external temperature is displayed next to this symbol if an external sensor is fitted

Adjustment menu The "MENU" button calls up the adjustment menu. The meanings of the individual symbols are described in the following table.



Fig. 169 Adjustment menu

The values can be increased or reduced via the "+" or "-" symbols.

Symbol	Signification
	Set the desired temperature of +5 °C to +30 °C
	Set the water temperature in the boiler
	Set the heat output in electrical operation
	Button for heating in gas operation on/off
	Tool menu button
	AC button for switching on the automatic air conditioning (only visible when the Truma Aventa air conditioning system is installed)
	Button for activated functions



Tool menus The various heater functions can be called up and adjusted via the tool menus. The arrow symbols are used to change between the menus. The meanings of the individual symbols are described in the manufacturer's instruction manual.

Selecting the operating mode The hot-water heater can be operated with the following energy sources:

- Gas operation
- 230 V electrical operation
- Gas and 230 V electrical operation

The operating mode is selected from the operating unit.

Selecting gas operation:

- Press "" pushbutton. The pushbutton lights up green. The gas operation is activated.
- Press "" pushbutton again. The pushbutton lights up blue. The gas operation is switched off.

Selecting 230 V electrical operation:

- Press the "+" button next to the "" symbol until the desired heat output is reached.



- ▷ Select the output level during 230 V electrical operation in such a way that it corresponds to the 230 V connection protection:
 - Level 1 (1 kW) at 6 A
 - Level 2 (2 kW) at 10 A
 - Level 3 (3 kW) at 16 A

Selecting gas and 230 V electrical operation:



- ▷ If gas and 230 V electrical operation is selected and if the vehicle is connected to the 230 V power supply, then the hot-water heater at first only operates in 230 V electric operation. Only if the heat output is insufficient does the gas operation also automatically switch on.
- ▷ The gas operation is only possible when the regulator tap on the gas bottle and the gas isolator tap are opened.
- ▷ 230 V electrical operation is only possible when the vehicle is connected to the 230 V power supply.

When the heater is turned on, it starts with the last set operating mode.

Switching on the heater:

- Press "⏻" button. The Start screen appears in the display. The heater starts automatically.

Switching the heater off:

- Press "⏻" button. The heater is turned off.

Setting the rotational speed of the circulating pump



- ▷ The hot-water heater is equipped with a very powerful pump. Only operate the pump for approx. 5 minutes on full output when the system is emptied or the pipes are bled. Otherwise, this will increase wear; loud operating noises are the result.



Fig. 170 Speed reduction

The rotational speed of the circulating pump can be set with the control knob (Fig. 170,2). At a lower rotary speed, the operating sounds of the pump are quieter.

The control knob is located on the circulating pump (Fig. 170,1).

Setting the output:

- Turn the control knob (Fig. 170,2) in an anticlockwise direction. The output is reduced.
- Rotate the control knob in a clockwise direction. The output is increased.

3-way valve

For models with a rear bed, a 3-way valve is connected to the hot water heater circulation. The 3-way valve is installed in the rear garage. The 3-way valve can be accessed via an external flap.

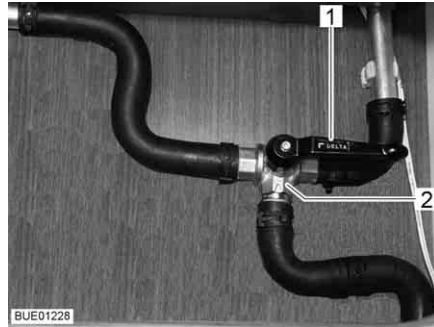

Fig. 171 3-way valve

Opening the heat circulation in the rear area:

- Set the lever (Fig. 171,1) of the 3-way valve (Fig. 171,2) parallel to the straight flow direction (Fig. 171).

Locking the heat circulation in the rear area:

- Set the lever (Fig. 171,1) of the 3-way valve (Fig. 171,2) transverse to the straight flow direction.

Alde heat exchanger (special equipment)



- ▷ The heat exchanger only works when the vehicle engine is running.
- ▷ If the heat exchanger is not being used (as in the summer), the heat exchanger on the stopcock should be shut off.

The heat exchanger can be used to heat the living area of the vehicle during travel without operating the hot-water heater in the living area.

The heat exchanger is connected to the vehicle engine's cooling circuit and thus has the same function as the vehicle heater.

Heat output is set with the living area's heating regulator.

The heat exchanger stopcock is located directly on the exchanger.

Turning on the vehicle heating by heat exchanger:

- Make sure the heat exchanger stopcock is open.
- Press the "⏻" button (Fig. 167,3) on the operating unit (Fig. 167). The Start screen appears in the display. That turns on the heating control system and makes the circulating pump run.
- Press "MENU" button (Fig. 167,2).
- Turn off gas operation or 230 V electrical operation (if turned on).
- Set the desired room temperature. To do that, press the "+" or "-" button next to the "🏠" symbol.

Turning off the vehicle heating by heat exchanger:

- Press the "⏻" button (Fig. 167,3) on the operating unit (Fig. 167).



Fig. 172 Alde heat exchanger

- Turning on:* ■ Set stopcock handle (Fig. 172,1) parallel to the pipe.
- Shutting off:* ■ Set drain cock handle (Fig. 172,1) at a right angle to the pipe.

Position The heat exchanger is installed in the rear bench seat of the central seating group.

Alde auxiliary circulating pump (special equipment)



- ▷ The auxiliary circulating pump works only if the heat exchanger has been installed and started, and the hot-water heater is running.

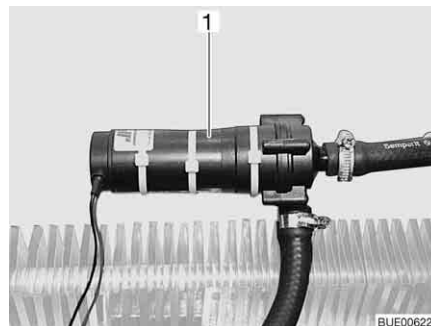

Fig. 173 Auxiliary circulating pump

The auxiliary circulating pump (Fig. 173,1) can be used to heat the vehicle engine when parked.

The auxiliary circulating pump is connected to the vehicle engine's cooling circuit and thus functions as an engine heater.



Fig. 174 Operating switch for auxiliary circulating pump

The auxiliary circulating pump switch (Fig. 174) is located next to the hot-water heater operating unit. The yellow indicator lamp illuminates when the pump is operated.

9.2.6 Auxiliary heat exchanger (special equipment)



- ▷ The fan on the auxiliary heat exchanger can be used for ventilation.
- ▷ The heat output is continuously adjusted.

The auxiliary heat exchanger is built into the bench seat.

The auxiliary heat exchanger may be used to provide the vehicle's living area with additional heat during the journey.

The auxiliary heat exchanger is integrated into the heat circulation of the base vehicle and is therefore only in operation when the vehicle engine is running.



Fig. 175 Operating controls for auxiliary heat exchanger

- Switching on:**
- Push the sliding regulator (Fig. 175,1) of the flow control downward to the desired position. The water circulation is open.
 - Turn the fan switch (Fig. 175,2) for the circulation fan in a clockwise direction.
- Switching off:**
- Turn the fan switch (Fig. 175,2) to "0".
 - Push the sliding regulator (Fig. 175,1) of the flow control upward as far as it goes.

9.2.7 Electrical floor warming unit (special equipment)



- ▶ On models with electrical floor warming unit, never drill holes in the floor or screw in any screws. Careful with sharp objects. There is danger of a power cut or a short circuit due to damage to a heater wire.



- ▷ Do not cover the transformer. Danger of overheating!



- ▷ The electrical floor warming unit only operates if the vehicle is connected to the 230 V power supply.
- ▷ The output of the electrical floor warming unit alone is not sufficient to heat the living area.



Fig. 176 Transformer for electrical floor warming unit



Fig. 177 Switch for electrical floor warming unit

The transformer (Fig. 176,1) for the electrical floor warming unit is installed either in the bench seat or in the bedding box, depending on the model.

Switching on:

- Connect the vehicle to the 230 V power supply (see chapter 8).
- Press the rocker switch (Fig. 177,2). The indicator lamp (Fig. 177,1) on the switch is illuminated.

Switching off:

- Press the rocker switch (Fig. 177,2). The indicator lamp (Fig. 177,1) on the switch goes off.

After switching off, the floor remains warm for a while, due to residual heat. If the transformer is overloaded, the overload protection is actuated. The pin (Fig. 176,2) jumps out.

Switching on overload protection:

- Press the pin (Fig. 176,2) on the overload protection when the transformer is cooled.

9.2.8 Independent vehicle heater (special equipment)



- ▶ Do not operate the heater in closed spaces. Danger of suffocation!
- ▶ Do not operate the heater at petrol stations. Danger of explosion!

The inside and the engine can be heated with the independent vehicle heater. The heating of the engine can be switched off.

The independent vehicle heater can be turned on and off manually or with a timer. The time for the heating to start can be exactly preselected from 1 minute to 24 hours. It is possible to program three switching on times, of which only one can be activated. The maximum permitted operation time is 60 minutes.

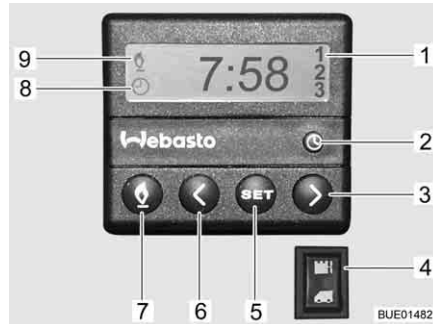

Fig. 178 Operating unit for independent vehicle heater

Switching on the heater for the base vehicle:

- Set the heater control to "Warm".
- Switch on the fan.
- For continuous operation: Set the fan to the lowest fan setting (due to battery capacity).
- To quickly heat up the vehicle: Set the fan to a higher fan setting.
- Open and close the base vehicle's air outlet nozzles as desired.

Switching on the independent vehicle heater manually:

- Press the button (Fig. 178,7). The heating mode is displayed by the symbol (Fig. 178,9). The fan will only be switched on when there is a coolant temperature of 30 °C.

Switching off the independent vehicle heater manually:

- Press the button (Fig. 178,7). The symbol (Fig. 178,9) goes off.

Switching on the engine heating:

- Press the lower part of the switch (Fig. 178,4). Engine is preheated. The fan is switched on immediately.

Switching off the engine heating:

- Press the upper part of the switch (Fig. 178,4). Engine stays cold.

Setting the time:

- Press the button (Fig. 178,2). The time setting is displayed by the symbol (Fig. 178,8).
- Set the time with the buttons (Fig. 178,3 and 6).

Programming heating start:

- Press the button (Fig. 178,5).
- Set the switching on time within ten seconds, with the buttons (Fig. 178,3 and 6).

Selecting programmed switching on time:

- Keep pressing the button (Fig. 178,5) until the selected programme number (Fig. 178,1) appears in the display.

9.3 Air conditioning unit (special equipment)

9.3.1 Dometic



▷ If the unit is operating, always open at least one ventilation flap.



▷ In the winter, vehicle heating can be supported but not replaced by the air conditioning unit.

▷ Also read the manufacturer's instruction manual.

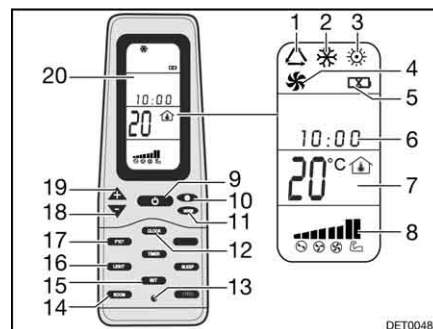

Fig. 179 Remote control

- 1 Symbol for automatic mode
- 2 Symbol for cold mode
- 3 Symbol for warm mode
- 4 Symbol for ventilation mode
- 5 Symbol for discharged batteries
- 6 Time
- 7 Temperature display
- 8 Fan speed display
- 9 ON/OFF button
- 10 Fan speed button
- 11 "MODE" button
- 12 "CLOCK" button
- 13 Reset key
- 14 Interior temperature display button "ROOM"
- 15 Store button "SET"
- 16 Light button "LIGHT"(optional)
- 17 Temperature unit change button "F/C"
- 18 Temperature decrease button "-"
- 19 Temperature increase button "+"
- 20 Display

To execute the individual switching commands, always point the remote control in the direction of the ceiling unit.

Operating modes

The air conditioning unit has the following operating modes:

- Automatic
- Ventilation, manual
- Cooling, manual
- Heating, manual

Switching on:

- Press the ON/OFF button (Fig. 179,9).
- Press the "Mode" button (Fig. 179,11) as often as required until the required mode (Fig. 179,1, 2, 3 or 4) is indicated on the display (Fig. 179,20).
- Use the "+" (Fig. 179,19) and "-" (Fig. 179,18) buttons to set the desired temperature.
- Use the fan speed button (Fig. 179,10) to select the desired fan level.

Switching off:

- Press the ON/OFF button (Fig. 179,9).



Fig. 180 Air conditioning unit (Dometic)

LED The LED (Fig. 180,4) on the ceiling unit (Fig. 180,1) displays the operating status of the air conditioning unit:

Status LED	Signification
Off	Air conditioning unit off
Orange	Air conditioning unit ready to operate
Green	Air conditioning unit in operation
Red (continuous)	No 230 V power connection
Red (flashes once intermittently)	Fault in the interior temperature gauge
Red (flashes twice intermittently)	Fault in the exterior temperature gauge

Air current The air current can be directed in different directions. The distribution of the air current toward the front or back is continuously adjustable.

Adjusting air current:

- Align the two deflectors (Fig. 180,3 and 5) in the desired position.
- Rotate knob (Fig. 180,2) on sliding regulator in an anticlockwise direction. The sliding regulator for air distribution is released.
- Slide the sliding regulator forwards or backwards to the desired position. The side on which the sliding regulator is located is closed.
- Turn the knob tight in the clockwise direction.

9.3.2 Telair



- ▷ Always wait at least 2 minutes between switching off and switching on again. Otherwise the compressor will be damaged.
- ▷ If the unit is operating, always open at least one ventilation flap.



- ▷ The air conditioning unit only runs if the vehicle is connected to a 230 V power supply.
- ▷ In the winter, vehicle heating can be supported but not replaced by the air conditioning unit.
- ▷ Following switch-on the air conditioning unit needs approx. 3 minutes until the compressor starts to run and cold air or hot air is output.
- ▷ Also read the manufacturer's instruction manual.

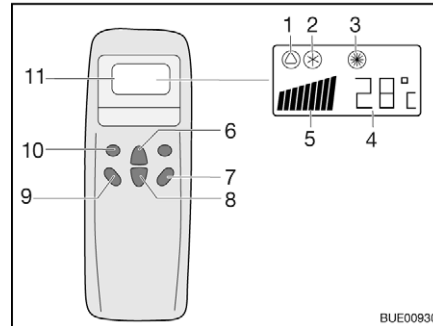

- 1 Symbol for automatic
- 2 Symbol for cooling
- 3 Symbol for heater
- 4 Temperature (set) display
- 5 Fan speed display
- 6 Temperature increase button
- 7 "ON/OFF" button
- 8 Temperature reduction button
- 9 Ventilation speed button
- 10 "Mode" button
- 11 Display

Fig. 181 Remote control

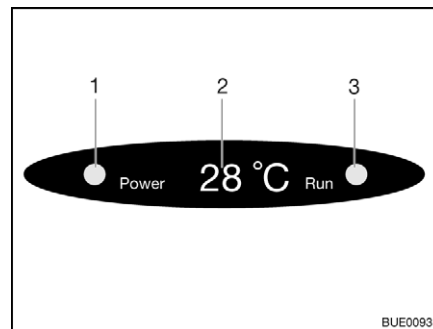

- 1 Mains connection indicator lamp
- 2 Temperature (current) display
- 3 Mode indicator lamp
Green: Cooling
Red: Heater

Fig. 182 Display on the diffuser

To execute the individual switching commands, always point the remote control in the direction of the receiver.

Operating modes

- Automatic
- Cooling
- Heater

Switching on:

- Press the "ON/OFF" button (Fig. 181,7).
- Press the "Mode" button (Fig. 181,10) as often as required until the required mode (Fig. 181,1, 2 or 3) is indicated on the display. The corresponding indicator lamp on the diffuser display (Fig. 182,3) lights up.
- Use the temperature increase button (Fig. 181,6) or temperature reduction button (Fig. 181,8) to set the required temperature.
- Use the ventilation speed button (Fig. 181,9) to select the required ventilation level.

Switching off:

- Press the "ON/OFF" button (Fig. 181,7).



- ▷ If the air conditioning unit has run in heating mode, the blower will run on for some minutes in order to dissipate the heat completely.

9.4 Boiler



- ▶ Never let gas escape unburned due to danger of explosion.
- ▶ Never run the boiler in gas operation when refuelling, on ferries or in the garage. Danger of explosion!
- ▶ Never operate the boiler in gas operation in closed spaces (e.g. garages). Danger of poisoning and suffocation!
- ▶ The water in the boiler can be heated up to 65 °C. Risk of scalding!



- ▷ Never use boiler when empty.
- ▷ If the boiler is not being used, empty it if there is any risk of frost.
- ▷ Only operate the boiler with the maximum temperature setting if you require a large quantity of warm water. This protects the boiler against the build-up of limescale.



- ▷ Do not use the water from the boiler as drinking water.

9.4.1 Models with waste gas vent on the right-hand side of the vehicle



- ▶ If the awning is put up and the boiler is running in gas operation, exhaust gases from the boiler can escape into the awning area. Danger of suffocation! Make sure the area is sufficiently ventilated.

9.4.2 Truma Combi boiler

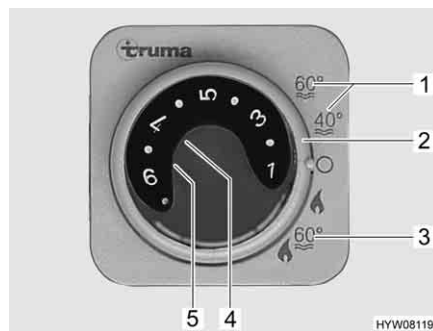

- 1 Summer operation water temperature 40 °C or 60 °C
- 2 Rotary switch
- 3 Winter operation "Heater and boiler"
- 4 Red indicator lamp "Fault"
- 5 Yellow indicator lamp "Boiler heating-up phase"

Fig. 183 Operating unit for heater/boiler

The boiler is integrated into the heater and is operated with gas (gas operation) or with gas and/or electricity (gas and 230 V electrical operation). The boiler is switched on by turning the rotary switch (Fig. 183,2) on the operating unit (Fig. 183). The type of energy is pre-selected (gas and 230 V electrical operation) with the energy selector switch (Fig. 185).

In winter operation "Heater and boiler" (Fig. 183,3) the water in the boiler is automatically heated up when the heater is switched on. If the heater switches off after the required room temperature has been reached, the boiler will continue to heat up until the set water temperature has been reached.

In summer operation (Fig. 183,1) only the water in the boiler is heated up to either 40 °C or 60 °C. The water is heated to 60 °C in approx. 25 minutes. The yellow indicator lamp (Fig. 183,5) illuminates during the boiler heating-up period.

The power supply for the appliance cannot be interrupted by means of the 12 V main switch. When there is a fault, the red indicator lamp (Fig. 183,4) on the operating unit illuminates (see chapter 14).

Safety/drainage valve

The boiler is equipped with a safety/drainage valve (Fig. 184). The safety/drainage valve prevents water in the boiler from freezing, when there is frost and the heater is not switched on.



- ▷ When the vehicle is not used for a long period of time, open the safety/drainage valve and empty the boiler.
- ▷ At temperatures below 2 °C the safety/drainage valve opens automatically. Only if the temperature of the safety/drainage valve lies above 6 °C can it be shut again.
- ▷ The water pump and the water fittings are not protected against freezing by the safety/drainage valve.



- ▷ The drainage neck of the safety/drainage valve has to be free of dirt (e.g. leaves, ice) at all times.

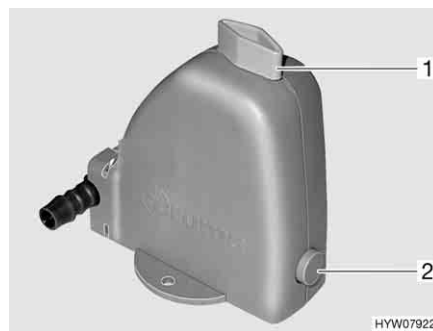

Fig. 184 Safety/drainage valve of the boiler

Position See chapter 16.

Variant: Boiler with gas operation

The boiler is operated exclusively with gas.

Winter operation

In the "heater and boiler" switch setting in winter operation, the boiler is already switched on.

Summer operation

In summer operation the water can be heated up to 40 °C or 60 °C.

Switching on:

- Open the regulator tap on the gas bottle and the gas isolator tap "Heater/boiler".
- Set the rotary switch (Fig. 183,2) on the operating unit (Fig. 183) to "Summer operation" (Fig. 183,1).

The yellow indicator lamp (Fig. 183,5) is illuminated during the heating up period. When the set water temperature is reached, the period of heating up is finished and the yellow indicator lamp fades.

Switching off:

- Set the rotary switch (Fig. 183,2) on the operating unit (Fig. 183) to "O".
- Close the gas isolator tap "Heater/boiler" and the regulator tap on the gas bottle.

**Variant: Boiler with gas
and 230 V electrical
operation**

- ▷ 230 V electrical operation is only possible when the vehicle is connected to the 230 V power supply.
- ▷ Select the output level for 230 V electrical operation so that it corresponds to the fuse protection of the 230 V connection (900 W for 3.9 A fuse, 1800 W for 7.8 A fuse).
- ▷ When the boiler on the operating unit is set to summer operation and the energy selector switch is set to mixed operation, the heater will only heat the water in the boiler. For this, the heater only runs in 230 V operation. The gas burner is not switched on.

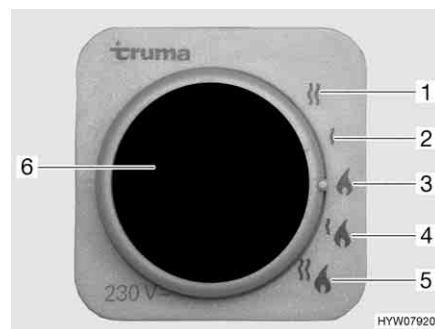

- 1 230 V electrical operation (1800 W)
- 2 230 V electrical operation (900 W)
- 3 Gas operation
- 4 Gas and 230 V electrical operation (900 W)
- 5 Gas and 230 V electrical operation (1800 W)
- 6 Yellow indicator lamp "230 V electrical operation"

Fig. 185 Energy selector switch for heater/boiler

The boiler can be operated with different types of energy:

- Gas operation (Fig. 185,3)
- 230 V electrical operation with the output levels 900 W (Fig. 185,2) or 1800 W (Fig. 185,1)
- Gas and 230 V electrical operation (mixed operation) with the output levels 900 W (Fig. 185,4) or 1800 W (Fig. 185,5)

The combination gas operation and 230 V electrical operation reduces the heating-up time for the boiler (only possible when the boiler the operating unit (Fig. 183) is set to winter operation).

When 230 V electrical operation is selected, the yellow indicator lamp (Fig. 185,6) illuminates.

Filling/emptying the boiler

The boiler can be supplied with water from the water tank.

Filling the boiler with water:

- Switch on 12 V power supply on the panel.
- Close the safety/drainage valve. Turn the knob (Fig. 184,1) perpendicular to the safety/drainage valve and push the push button (Fig. 184,2) in.
- Set all the water taps to "Hot" and open them. The water pump is turned on. The warm water pipes are filled with water.
- Keep the taps open until the water flowing out of the taps has no bubbles in it. This is the only way to ensure that the boiler is full of water.
- Close all water taps.

Emptying the boiler:

- Set the rotary switch (Fig. 183,2) on the operating unit (Fig. 183) to "O".
- Open the safety/drainage valve. To do this turn the knob (Fig. 184,1) parallel to the safety/drainage valve. The push button (Fig. 184,2) jumps out. The boiler is drained to the outside by the safety/drainage valve.
- Check whether the water has been drained completely from the boiler (approx. 12 litres).



- ▷ Further information can be obtained in the manufacturer's instruction manual.

9.4.3 Truma boiler with operating unit CP plus

The boiler for producing hot water is integrated into the heater and is gas operated, or operated with gas and/or electricity (gas and 230 V electrical operation). The boiler is operated with the operating unit (Fig. 165). 230 V electrical operation is only possible if the vehicle is connected to the 230 V power supply.

The operating unit is described in the "Hot-air heater with operating unit CP plus" section.

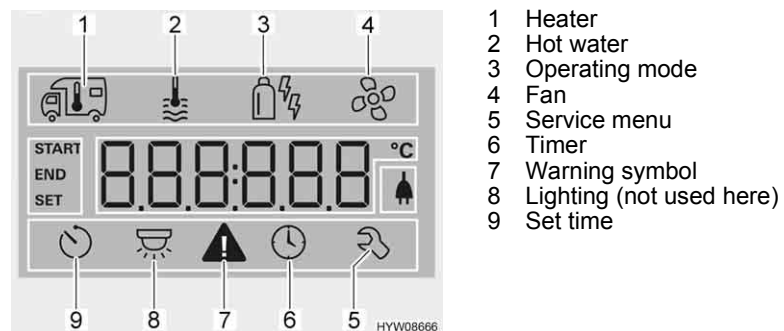

Fig. 186 Display

Switching on hot water production:

- Open the regulator tap on the gas bottle and the gas isolator tap "Heater/boiler".
- Turn rotary push button (Fig. 165,6) until the hot water menu symbol (Fig. 186,2) flashes.
- Press rotary push button.
- Turn rotary push button until the required value is displayed:
 - OFF: Hot water production is switched off.
 - 40°: Hot water is heated to 40 °C.
 - 60°: Hot water is heated to 60 °C.
 - BOOST: Fast heating of hot water (boiler priority) for max. 40 minutes. The water temperature is then held at a higher level for two reheating cycles (approximately 62 °C).
- Press rotary push button to save the value set. The symbol in the status line (Fig. 165,2) flashes until the hot water temperature set is reached. If you do not wish to change the value originally set: Press back button (Fig. 165,7).

Switching off hot water production:

- Turn rotary push button until OFF is displayed. Press rotary push button to save.

Safety/drainage valve

The boiler is equipped with a safety/drainage valve (Fig. 187). The safety/drainage valve prevents water in the boiler from freezing, when there is frost and the heater is not switched on.



- ▷ When the vehicle is not used for a long period of time, open the safety/drainage valve and empty the boiler.
- ▷ At temperatures below 2 °C the safety/drainage valve opens automatically. Only if the temperature of the safety/drainage valve lies above 6 °C can it be shut again.
- ▷ The water pump and the water fittings are not protected against freezing by the safety/drainage valve.



- ▷ The drainage neck of the safety/drainage valve has to be free of dirt (e.g. leaves, ice) at all times.

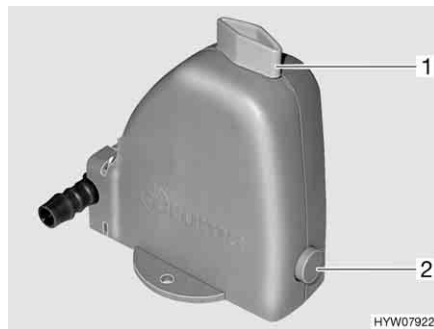

Fig. 187 Safety/drainage valve of the boiler

Position See chapter 16.

Filling/emptying the boiler

The boiler can be supplied with water from the water tank.

Filling the boiler with water:

- Switch on 12 V power supply on the panel.
- Close the safety/drainage valve. Turn the knob (Fig. 187,1) perpendicular to the safety/drainage valve and push the push button (Fig. 187,2) in.
- Set all the water taps to "Hot" and open them. The water pump is turned on. The warm water pipes are filled with water.
- Keep the taps open until the water flowing out of the taps has no bubbles in it. This is the only way to ensure that the boiler is full of water.
- Close all water taps.

Emptying the boiler:

- Switch off hot water production.
- Open the safety/drainage valve. To do this turn the knob (Fig. 187,1) parallel to the safety/drainage valve. The push button (Fig. 187,2) jumps out. The boiler is drained to the outside by the safety/drainage valve.
- Check whether the water has been drained completely from the boiler (approx. 10 litres).



- ▷ Further information can be obtained in the manufacturer's instruction manual.
- ▷ For more information about operation, see the "Hot-air heater with operating unit CP plus" section.

9.4.4 Alde boiler

Switching the boiler on/off

The boiler is integrated in the hot-water heater. A separate operation is not possible. For operating the hot-water heater, see section 9.2.5.

Filling/emptying the boiler

The boiler can be supplied with water from the water tank.



- ▷ Depending on the model, the vehicle is fitted with one or two drain cocks.

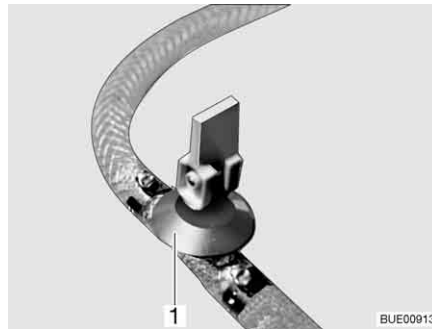

Fig. 188 Drain cock

Filling the boiler with water:

- Close the drain cock(s). Position the rocking lever (Fig. 188,1) horizontally.
- Switch on 12 V power supply on the panel.
- Set all the water taps to "Hot" and open them. The water pump is turned on. The warm water pipes are filled with water.
- Keep the taps open until the water flowing out of the taps has no bubbles in it. This is the only way to ensure that the boiler is full of water.
- Close all water taps.

Emptying the boiler:

- Switch off boiler.
- Open all water taps and set to the central position.
- Open drain cock(s) (Fig. 188). To do so, set the rocking lever (Fig. 188,1) in a vertical position. The boiler is drained to the outside.
- Check whether the water has been drained completely from the boiler (approx. 10 litres).



- ▷ For further information, see the separate manufacturer's instruction manual and observe the maintenance instructions found in chapter 12.

Position of the drain cock(s)

See chapter 16.

9.5 Cooker



- ▶ Never let gas escape unburned due to danger of explosion.
- ▶ Before using the cooker make sure that there is sufficient ventilation. Open windows or the skylight.
- ▶ Do not use gas cooker or gas oven for heating.
- ▶ Do not fit any curtains in the immediate proximity of the cooker. Fire hazard!
- ▶ Always protect your hands with cooking gloves or potholders when handling hot pots, pans and similar items. There is a risk of injury.

9.5.1 Gas cooker



- ▶ During activation and operation of the gas cooker, no flammable objects or highly inflammable objects such as dishcloths, napkins etc. must be near the gas cooker. Fire hazard!
- ▶ The process of ignition must be visible from above and must not be covered by cooking pans placed on the cooker.
- ▶ The gas cooker lid is held closed by a spring. When closing there is danger of getting injured!



- ▷ Do not place hot objects such as cooking pans on the sink cover. The plastic can become deformed.
- ▷ Do not use the glass gas cooker lid as a hob.
- ▷ Do not close the gas cooker lid while the gas cooker is in operation.
- ▷ Do not apply pressure on the gas cooker lid when it is closed.
- ▷ Do not place hot cooking pans on the gas cooker lid.
- ▷ Keep the gas cooker lid open after cooking until the burners are cool. Otherwise the glass plate could shatter.



- ▷ Only use pots and pans whose diameter is appropriate for the gas cooker burners.
- ▷ When the flame goes out, the thermocouple automatically cuts the gas supply.
- ▷ Further information can be obtained in the device manufacturer's instruction manual.

The vehicle kitchen unit is fitted with a three-burner gas cooker.

The operating controls for the gas cooker are located directly at the gas cooker.

A heat guard (Fig. 189,1) protects the furniture near the gas cooker.



Fig. 189 Gas cooker

- Switching on:**
- Open the regulator tap on the gas bottle and the gas isolator tap "Cooker".
 - Open the gas cooker lid (Fig. 189,1).
 - Turn the control knob (Fig. 189,2) on the burner you wish to use to the ignition position (large flame).
 - Press the control knob down and hold it.
 - Light the burner with a gas lighter, a match or other suitable means of lighting.
 - Once the flame is burning, the control knob must be held down for 10 to 15 seconds, until the thermocouple automatically keeps the gas supply open.
 - Release the control knob and turn to the desired setting.
 - If ignition is unsuccessful, repeat the entire procedure.

- Switching off:**
- Turn the control knob to the 0-position. The flame fades.
 - Close the gas isolator tap "Cooker" and the regulator tap on the gas bottle.

9.5.2 Gas cooker with gas oven and gas grill (only Argos 747-2)

Gas cooker



- ▶ During activation and operation of the gas cooker, no flammable objects or highly inflammable objects such as dishcloths, napkins etc. must be near the gas cooker. Fire hazard!
- ▶ The process of ignition must be visible from above and must not be covered by cooking pans placed on the cooker.
- ▶ If there is a flame protection, always put it up when using the gas cooker.
- ▶ The gas cooker lid is held closed by a spring. When closing there is danger of getting injured!



- ▷ Do not use the glass gas cooker lid as a hob.
- ▷ Do not close the gas cooker lid while the gas cooker is in operation.
- ▷ Do not apply pressure on the gas cooker lid when it is closed.
- ▷ Do not place hot cooking pans on the gas cooker lid.
- ▷ Keep the gas cooker lid open after cooking until the burners are cool. Otherwise the glass plate could shatter.



- ▷ Only use pots and pans whose diameter is appropriate for the gas cooker burners.
- ▷ When the flame goes out, the thermocouple automatically cuts the gas supply.
- ▷ Further information can be obtained from the separate instruction manual "Gas cooker".

The vehicle kitchen unit is fitted with a four-burner gas cooker.

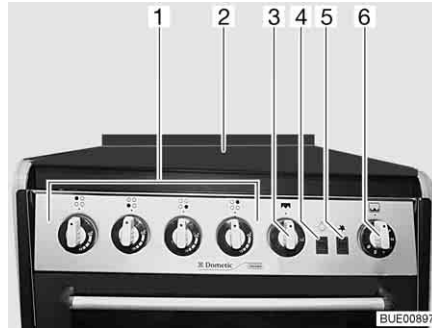

Fig. 190 Gas cooker with oven and grill

Switching on:

- Open the regulator tap on the gas bottle and the gas isolator tap "Cooker".
- Open the gas cooker lid (Fig. 190,2).
- Turn the control knob (Fig. 190,1) on the burner you wish to use to the ignition position (large flame).
- Press the lighting knob (Fig. 190,5) until there is a flame.
- Once the flame is burning, the control knob must be held down for 10 to 15 seconds, until the thermocouple automatically keeps the gas supply open.
- Release the control knob and turn to the desired setting.
- If ignition is unsuccessful, repeat the entire procedure.

Switching off:

- Turn the control knob to the 0-position. The flame fades.
- Close the gas isolator tap "Cooker" and the regulator tap on the gas bottle.

Gas oven and gas grill



- ▶ Keep the ventilation openings on the gas oven open at all times.
- ▶ There must be no flammable or highly inflammable objects such as dishcloths, clothes, etc. near the gas oven when it is being lit or during operation. Fire hazard!
- ▶ The oven flap must remain open when it is being lit.
- ▶ If ignition has not taken place, repeat the entire procedure. If necessary, check if there is gas and/or current in the gas oven.
- ▶ If the gas oven still does not work, close the gas isolator tap and notify your service centre.
- ▶ If the burner flame is accidentally extinguished, turn the control knob to the "0" position and leave the burner off for at least 1 minute. Then ignite it again.



- ▷ Before using the gas oven for the first time run it for 30 minutes at maximum temperature without any contents.
- ▷ The switch (Fig. 190,4) is used to turn the oven light on and off.

- Switching on the gas grill:*
- Open the regulator tap on the gas bottle and the gas isolator tap "Cooker".
 - Completely open oven flap.
 - Lightly press the control knob (Fig. 190,3) and turn to lighting position (large flame).
 - Press the lighting knob (Fig. 190,5) until there is a flame.
 - Once the flame is burning, the control knob must be held down for 10 to 15 seconds, until the thermocouple automatically keeps the gas supply open.
 - Release the control knob and turn to the desired setting.

- Switching on the gas oven:*
- Open the regulator tap on the gas bottle and the gas isolator tap "Cooker".
 - Completely open oven flap.
 - Press the control knob (Fig. 190,6) slightly and turn it to an ignition position between 1 and 6.
 - Press the lighting knob (Fig. 190,5) until there is a flame.
 - Once the flame is burning, the control knob must be held down for 10 to 15 seconds, until the thermocouple automatically keeps the gas supply open.
 - Release the control knob and turn to the desired setting.

- Switching off the gas oven and gas grill:*
- Turn the control knob to the 0-position. The flame fades.
 - Close the gas isolator tap "Cooker" and the regulator tap on the gas bottle.

9.5.3 Gas oven (Dometic) (special equipment)



- ▶ Keep the ventilation openings on the gas oven open at all times.
- ▶ There must be no flammable or highly inflammable objects such as dishcloths, clothes, etc. near the gas oven when it is being lit or during operation. Fire hazard!
- ▶ If ignition has not taken place, repeat the entire procedure. If necessary, check if there is gas and/or current in the gas oven.
- ▶ If the gas oven still does not work, close the gas isolator tap and notify your service centre.
- ▶ If the burner flame is accidentally extinguished, turn the control knob to "0" and leave the burner off for at least 1 minute. Then ignite it again.
- ▶ Parts of the gas oven become very hot during operation. Never touch hot parts with bare hands.
- ▶ Place the meals, wire rack and drip pan into the gas oven so that they do not come into contact with the flame.
- ▶ Only ignite the oven and grill when the oven door is open.
- ▶ Always leave the oven door half open when grilling.
- ▶ Do not use the grill for longer than 25 minutes.



- ▷ There are two different versions of the gas oven, depending on the model. Although their appearance is not identical, operation is the same for both.
- ▷ Depending on the model the gas oven may come equipped with a grill.
- ▷ Before using the gas oven for the first time run it for 30 minutes at maximum temperature without any contents.



- ▷ When the flame goes out, the thermocouple automatically cuts the gas supply.
- ▷ A safety switch prevents ignition when the oven door is closed.
- ▷ If the ignition procedure fails repeatedly, turn the control knob to "O". Wait at least 1 minute and then ignite the gas oven manually. If necessary, check if there is gas and/or current in the gas oven. If the gas oven still does not work, close the gas isolator tap and notify your service centre.
- ▷ Further information can be obtained in the manufacturer's instruction manual.

The gas oven is equipped with electronic ignition.





Fig. 191 Gas oven (Dometic TecTower)



Fig. 192 Gas oven (Dometic)

The meaning of the symbols on the control knobs (Fig. 191,1 and Fig. 192,1) of the two gas ovens is identical:

-  and  mean oven
-  and  mean grill.

Switching the oven on:

- Open the regulator tap on the gas bottle and the gas isolator tap "Oven".
- Open oven door completely. The safety switch then releases the ignition.
- Press and hold control knob and turn it anti-clockwise to the required setting. Keep control knob pressed for a further 5-10 seconds. Ignition will take place automatically.
- Release control knob.
- Close oven door.

Switching the grill on:

- Open the regulator tap on the gas bottle and the gas isolator tap "Oven".
- Open the oven door to at least the first locking position (approx. 45°).
- Press and hold control knob and turn it clockwise to the grill symbol. Keep control knob pressed for a further 5-10 seconds. Ignition will take place automatically.
- Release control knob.



- ▷ Do not close the oven door when grilling.

Switching off:

- Turn the control knob to "O". The flame fades.
- Close the gas isolator tap "Oven" and the regulator tap on the gas bottle.

9.5.4 Microwave oven (special equipment)



- ▶ Only qualified personnel may repair the microwave oven. Improper repairs can cause major risks to the user.
- ▶ The protection device against the escape of microwave energy should never be removed.
- ▶ Use the microwave oven only if it has been properly installed.
- ▶ Only use the microwave oven when the door seal is free of damage.
- ▶ Never leave the microwave oven unattended when it is in operation.
- ▶ If there is smoke, keep the microwave oven closed, switch it off and interrupt the power supply.



- ▷ Operate the microwave oven only with the rotary plate and the rotary cross in place.
- ▷ Use only crockery suitable for microwave use.
- ▷ Only operate the microwave with appropriate contents and never run it empty.



- ▷ For cooking times under 2 minutes: First twist the cooking time control knob past "2" and then twist it back to the desired cooking time.
- ▷ Further information can be obtained in the manufacturer's instruction manual.



Fig. 193 Operating controls for microwave oven

Switching on:

- Press the key (Fig. 193,3) to open the door and place food into the cooking area.
- Close the door. A clicking noise can be heard when it engages.
- Select the output on the control knob (Fig. 193,1).
- Select the cooking time with the control knob (Fig. 193,2). Cooking begins.

The end of the cooking process is signaled by a signal tone. The microwave oven will switch off automatically.

Switching off:

- Press the key (Fig. 193,3) to open the door and take out the food.

9.5.5 Extractor hood (partially special equipment)

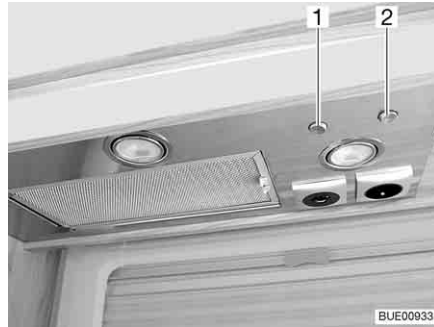

Fig. 194 Extractor hood

The cooking area is equipped with an extractor hood. The powerful fan blows the cooking steam directly outside. To switch on the extractor hood, press the right flip switch (Fig. 194,2).

Use the left flip switch (Fig. 194,1) to switch on the two lights in the extractor hood.

9.6 Refrigerator

During the journey, only operate the refrigerator via the 12 V power supply. At high ambient temperatures the refrigerator is unable to reach its full cooling power. At high external temperatures, the full cooling power of the cooling unit is only guaranteed if the refrigerator is ventilated sufficiently. In order to achieve a better ventilation the refrigerator ventilation grill can be removed.

If the refrigerator is to be operated at low external temperatures, the manufacturer recommends the use of a winter cover for the refrigerator ventilation grills. In this, the following applies:

Temperature	Cover
Below 10 °C	Winter cover (only lower ventilation grill for refrigerators with capacity below 130 litres)
Below -5 °C	Isolated winter cover (only lower ventilation grill)



- ▷ If the temperatures are higher than the indicated values, it is absolutely necessary to remove the winter cover. Otherwise the vehicle could be damaged.



- ▷ When leaving the vehicle, always mount the refrigerator ventilation grill. Otherwise water can enter during rain.
- ▷ The cooling power of the refrigerator depends on the vehicle setup. The cooling power can decrease if the vehicle is inclined by 5° or more. Therefore, always park the vehicle on level ground.
- ▷ Absorption refrigerators operate at normal room temperature (approx. 21 °C) within the specified temperature range. At significantly higher ambient temperatures (> 30 °C), the cooling power is reduced. This is because the "evaporating temperature" of the refrigerant is lower in absorption refrigerators than it is in compressor refrigerators.

9.6.1 Refrigerator ventilation grill

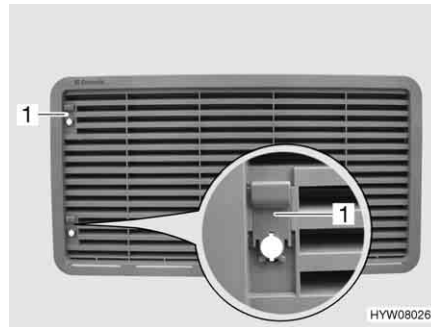

Fig. 195 Refrigerator ventilation grill (with sliding trap)

- Removal:*
- Push sliding trap (Fig. 195,1) upward.
 - Remove refrigerator ventilation grill.



Fig. 196 Refrigerator ventilation grill (with screw)

- Removal:*
- Turn screw (Fig. 196,1) one quarter turn using a coin.
 - Remove refrigerator ventilation grill.

9.6.2 Operation (Dometic 8 series with manual power selection MES)

Operating modes The refrigerator has 3 operating modes:

- Gas operation
- 230 V AC
- 12 V DC

The operating mode is set with the operating controls on the refrigerator panel.



- ▷ Select only one energy source.
- ▷ The refrigerator always requires a 12 V control voltage, regardless of which type of energy it is using. The control voltage is present as soon as the transformer/rectifier is switched on. Therefore the closed circuit current always flows even if the refrigerator is switched off. Always switch off the transformer/rectifier for a temporary lay-up.

Gas operation



- ▶ Never let gas escape unburned due to danger of explosion.

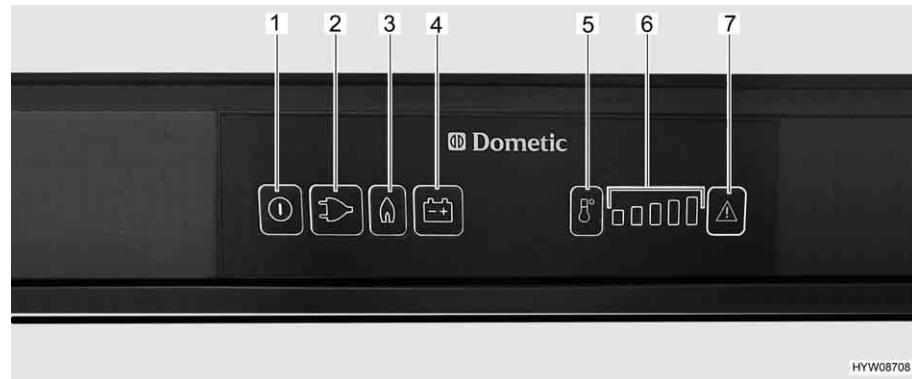

Fig. 197 Operating controls for the refrigerator (Dometic 8 series with MES)

- 1 On/Off button
- 2 Illuminated button for "230 V" mode
- 3 Illuminated button for "Gas" mode
- 4 Illuminated button for "12 V" mode
- 5 Temperature range selection button
- 6 Temperature ranges display
- 7 Illuminated "Fault" button

- Switching on:**
- Open the regulator tap on the gas bottle and the gas isolator tap "Refrigerator".
 - Press and hold the On/Off button (Fig. 197,1) for about 2 seconds. The refrigerator switches itself on. The button of the operating mode chosen most recently lights up.
 - If necessary, press the button for the operating mode "Gas" (Fig. 197,3). The button lights up. Gas supply is open. Ignition will take place automatically. A ticking sound can be heard until ignition has been completed successfully.
 - Use the temperature range selection button (Fig. 197,5) to set the refrigerating temperature.

- Switching off:**
- Press and hold the On/Off button for about 2 seconds. Refrigerator is switched off.
 - Close the gas isolator tap "Refrigerator" and the regulator tap on the gas bottle.

Electrical operation



- ▷ Close the gas isolator tap "Refrigerator" when the refrigerator is operated electrically.

The refrigerator can be operated with the following voltages:

- 230 V AC
- 12 V DC

Switching the 230 V operation on:

- Press and hold the On/Off button (Fig. 197,1) for about 2 seconds. The refrigerator switches itself on. The button of the operating mode chosen most recently lights up.
- If necessary, press the button for the operating mode "230 V" (Fig. 197,2). The button lights up.
- Use the temperature range selection button (Fig. 197,5) to set the refrigerating temperature.

Switching the 230 V operation off:

- Press and hold the On/Off button for about 2 seconds. Refrigerator is switched off.

Switching the 12 V operation on:

- Press and hold the On/Off button (Fig. 197,1) for about 2 seconds. The refrigerator switches itself on. The button of the operating mode chosen most recently lights up.
- If necessary, press the button for the operating mode "12 V" (Fig. 197,4). The button lights up.
- Use the temperature range selection button (Fig. 197,5) to set the refrigerating temperature.

Switching the 12 V operation off:

- Press and hold the On/Off button for about 2 seconds. Refrigerator is switched off.

When operated with 12 V, the refrigerator draws power only from the starter battery of the vehicle. The starter battery only supplies the refrigerator with 12 V when the vehicle engine is running. When the vehicle engine is not running, the refrigerator is cut off from the power supply in the living area. For this reason, change over to gas operation during prolonged driving breaks.



- ▷ Further information can be obtained from the separate instruction manual "Refrigerator".

9.6.3 Operation (Dometic RMD 8 series with automatic power selection and frame heater)

Operating modes

The refrigerator is equipped with automatic power selection (AES). If the selector switch is set to "AES", the AES automatically selects the optimum energy source and regulates the refrigerator operation. Manual intervention to select the type of power is possible but not required.

The AES selects from the following types of power:

- 12 V solar (special equipment)
- 230 V AC
- Gas
- 12 V DC

Choosing the available energy source highest on the list.



- ▷ The refrigerator always requires a 12 V control voltage, regardless of which type of energy it is using. The control voltage is drawn from the living room area battery. Therefore the closed circuit current always flows even if the refrigerator is switched off. Always disconnect the refrigerator from the battery for a temporary lay-up.

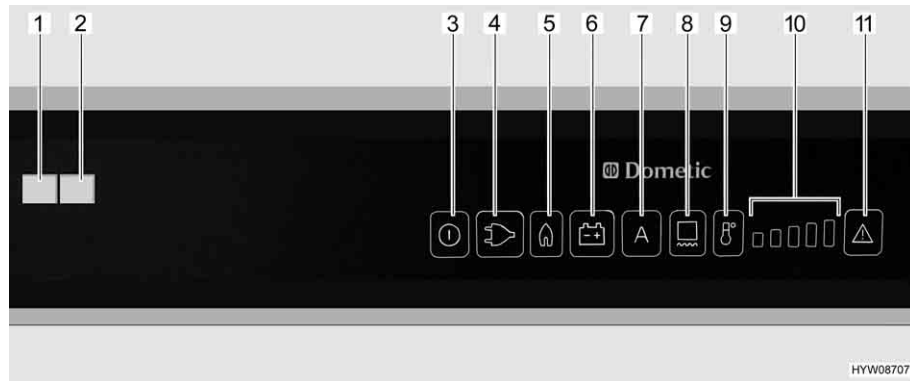

Fig. 198 Operating controls for the refrigerator (Dometic RMD)

- 1 "Fault" indicator lamp (visible when the refrigerator door is closed)
- 2 "Operating" indicator lamp (visible when the refrigerator door is closed)
- 3 On/Off button
- 4 Illuminated button for "230 V" mode
- 5 Illuminated button for "Gas" mode
- 6 Illuminated button for "12 V" mode
- 7 Illuminated button for "AES" mode (automatic power selection)
- 8 Illuminated button for frame heater
- 9 Temperature range selection button
- 10 Temperature range display
- 11 Illuminated button for "Fault"/"Reset" in gas mode

230 V operation

If the "AES" operating mode is set and the 230 V supply is connected, the AES selects this energy source first.

12 V operation

If the "AES" operating mode is set, the AES only selects 12 V operation if the vehicle engine is running (alternator signal D+).

Gas operation



- ▶ Never let gas escape unburned due to danger of explosion.



- ▷ If LPG is used, the gas burner must be cleaned more frequently.
- ▷ Open the regulator tap on the gas bottle and the gas isolator tap "Refrigerator".

If the "AES" operating mode is set, the 230 V supply is **not** connected and the vehicle engine is **switched off**, the AES selects the gas supply. When selecting gas operation the ignition fuse is opened automatically so gas can get into the burner. At the same time the electronic ignition is activated. If the gas flame is extinguished, e.g. by blast of wind, the ignition is activated immediately and re-ignites the gas. If there is a fault in gas operation, the illuminated buttons "Gas" (Fig. 198,5) and "Fault" (Fig. 198,11) flash. The "Fault" indicator lamp (Fig. 198,1) lights up and an alarm sounds for 20 seconds.

Change-over between energy sources

- ▶ Open flames are prohibited at petrol stations. If the stop takes longer than 15 minutes, the refrigerator has to be turned off at the energy selector switch.

When changing over from 230 V or 12 V to gas, delay times are built into the AES. For example, when changing over from 12 V operation to gas operation, a 15 minute delay is built in the AES. This prevents a change-over to gas operation when the vehicle is stopped briefly and the engine is switched off (e.g. stop to fill tank).

Refrigerating temperature control

When turned on the first time the refrigerator automatically selects the middle thermostat position. This position can be adjusted manually using the temperature range selection button (Fig. 198,9). The indicator lamps (Fig. 198,10) show the selected thermostat position. The refrigerating temperature for all three types of power is set with the temperature range selection button. It takes a few hours till the refrigerator reaches its normal operating temperature. When changing over the operating mode the thermostat setting will be maintained. The refrigerating temperature is retained regardless of the type of power being used.

Frame heater (FH)

- ▷ When the frame heater is turned on, it uses about 4 Watts, including in gas operation. To avoid running down the living area battery, in gas mode refrain from running the frame heater in continuous operation or turn the frame heater off entirely.

The following options are available for operating times of the frame heater:

- 2 hours
- 5 hours
- Continuous operation (switched on for 30 minutes, then for 5 minutes on and 5 minutes off in alternating intervals)

Setting operating time:

- Switch on the frame heater for a 2 hour period: Push button (Fig. 198,8) once. One bar is lit up on the temperature range display (Fig. 198,10).
- Switch on the frame heater for a 5 hour period: Push button (Fig. 198,8) twice. Two bars are lit up on the temperature range display (Fig. 198,10).
- Setting frame heater for continuous operation: Push button (Fig. 198,8) three times. Three bars are lit up on the temperature range display (Fig. 198,10).

The temperature range display (Fig. 198,10) shows the operating time of the frame heater for several seconds.

High external temperatures and high humidity can cause drops of water to form on the metal frame of the freezer compartment. This is why the refrigerator is equipped with a frame heater for the freezer compartment. If the temperature and humidity are high, switch on the frame heater by pressing the button (Fig. 198,8). This prevents corrosion. If the frame heater is switched on, the illuminated button (Fig. 198,8) is lit.

Manual operation

- Switching on:*
- Open the regulator tap on the gas bottle and the gas isolator tap "Refrigerator".
 - Press and hold the On/Off button (Fig. 198,3) for about 2 seconds. The refrigerator switches on and the previously set power type or "AES" is displayed.
 - Press the button for the desired energy type or the automatic "AES" mode.
 - Use the temperature range selection button (Fig. 198,9) to set the refrigerating temperature. The indicator lamps (Fig. 198,10) show the selected thermostat position.

When operated with 12 V, the refrigerator draws power only from the living area battery.



- ▷ If the refrigerator is manually set to "12 V", it will constantly consume current. Therefore, switch over to gas operation when the vehicle engine is **not** running, and the vehicle is **not** connected to the 230 V power supply.

- Switching off:*
- Press and hold the On/Off button (Fig. 198,3) for about 2 seconds. The refrigerator switches off and no displays are lit.
 - Close the gas isolator tap "Refrigerator" and the regulator tap on the gas bottle.

Additional functions

In automatic mode, "AES" and the type of power currently in use are displayed. The brightness of the display is reduced after a few seconds if no other buttons are pressed. When the door is opened, the interior light goes out after 2 minutes. If the door is open for longer than 2 minutes, the operating indicator lamp flashes and a warning signal sounds.



- ▷ Further information can be obtained from the separate instruction manual "Refrigerator".

9.6.4 Refrigerator door locking mechanism

With some models, the refrigerator has a separate freezer compartment. The specifications in this section correspondingly also apply to the door of the freezer compartment.



- ▷ During the journey the refrigerator door must always be closed and locked in the closed position.



- ▷ Lock the refrigerator door in ventilation position when the refrigerator is switched off. This prevents mould forming.

There are two positions for locking the refrigerator door in place:

- Closed refrigerator door during travel and when the refrigerator is in operation
- Slightly opened refrigerator door as a ventilation position when the refrigerator is switched off

Dometic 8 series

Fig. 199 Release button of the refrigerator door (Dometic 8 series)

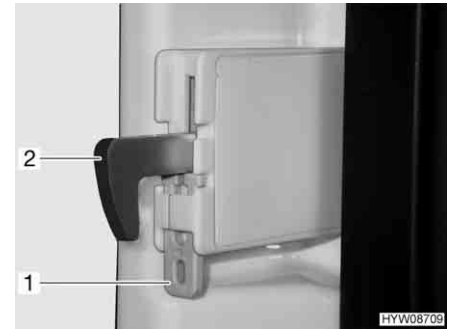

Fig. 200 Lock hook fixture

Opening: ■ Press the release button (Fig. 199,1) and open the refrigerator door.

Closing: ■ Close the refrigerator door. The lock hook engages audibly.

When the vehicle has been positioned, the lock hook can be fixed. The refrigerator door can now be opened without having to press the release button.

Fixing the lock hook: ■ Press the fixture (Fig. 200,1) upwards. The lock hook (Fig. 200,2) is pressed upwards and has no function.

Unlocking the lock hook: ■ Push the lock hook (Fig. 200,2) down. The lock hook functions again.

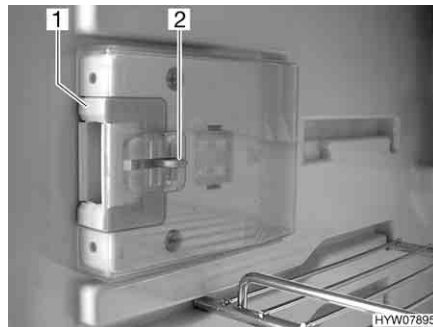

Fig. 201 Locking device in normal position

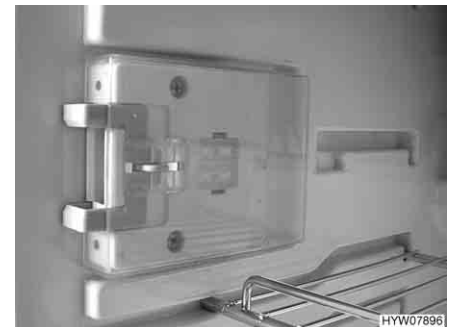

Fig. 202 Locking device in ventilation position

Locking in the ventilation position:

- Open the refrigerator door.
- Press down the unlocking device (Fig. 201,2).
- Push locking device (Fig. 201,1) forwards (Fig. 202).

If the refrigerator door is closed now, a gap will remain between the refrigerator door and the refrigerator.

Chapter overview

This chapter contains instructions regarding the sanitary fittings of the vehicle. The instructions address the following topics:

- complete water system
- water tank
- drinking water filler neck
- waste water installation
- waste water tank heater
- heater for the waste water pipes
- toilet compartment
- toilet

10.1 Water supply, general



- ▶ Fill water tank from supply systems that have been verified to provide drinking water quality.
- ▶ Only use such hoses or containers when filling that have been approved for use with drinking water.
- ▶ Thoroughly rinse filling hose or container with drinking water before use (2 to 3 times capacity).
- ▶ Empty filling hose or container completely after use and close openings of the filling hose or container.
- ▶ Water left standing in the water tank or in the water pipes becomes undrinkable after a short period. Therefore, before each use of the vehicle, thoroughly clean the water pipes and the water tank. After each use of the vehicle completely empty the water tank and the water pipes.
- ▶ In the case of lay-ups lasting more than a week disinfect the water system before using the vehicle (see chapter 11).



- ▷ If the vehicle is not used for several days or if it is not heated when there is a risk of frost, empty the entire water system. Make certain that the water pump is switched off on the panel. Otherwise, the water pump will overheat and may get damaged. Leave the water taps on in central position. Leave the safety/drainage valve (if there is one) and all drain cocks open. Frost damage to appliances, frost damage to the vehicle and deposits in water-carrying components can be avoided in this way.
- ▷ The water pump will overheat without water and can get damaged. Never operate water pump when the water tank is empty.

The vehicle is equipped with a fitted water tank. An electric water pump pumps the water to the individual water taps. Opening a water tap automatically switches on the water pump and pumps water to the tap.

The waste water tank collects the waste water. The water level in the water and waste water tanks can be checked on the panel.



- ▷ Before the water fittings can be used, the 12 V power supply and water pump on the panel must be turned on. Otherwise the water pump will not work.
- ▷ When the water tank is re-filled, an air bubble may form at the bottom of the pump. This air bubble will prevent water from being drawn in. Shake the water pump up and down energetically in the water.

10.2 Water system

10.2.1 Water tank

The volumes of the water tank differ from model to model. The water tank holds 120 l for models without a tandem axle and 130 l for models with a tandem axle.



- ▷ On water tanks with a capacity of 120 l, the filling volume is limited to 60 l for safety reasons (installed overflow). The panel has not been adjusted to this volume. The level indicator on the panel shows the actual amount of water in the tank.

If necessary or if there is a sufficiently large residual vehicle payload, the water tank can be filled up to its actual capacity. To do this, close overflow. The handle is located on or at the side of the water tank.

10.2.2 Auxiliary water tank (special equipment) (only Argos 747-2)

The auxiliary water tank holds 70 l. The auxiliary water tank is installed in the double floor and can be accessed via a side service flap.



Fig. 203 Auxiliary water tank

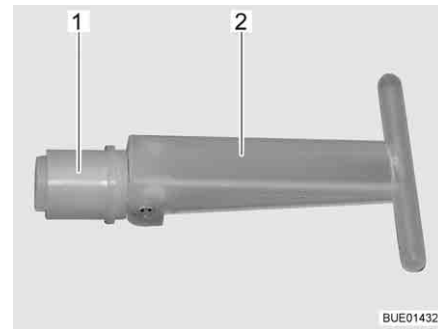

Fig. 204 Stopper

The auxiliary water tank and the water tank are both filled via the drinking water filler neck. Both tanks are connected to each other via a hose.

When the emptying valve (Fig. 203,2) is open, the fill quantity of the auxiliary water tank is limited to approximately 30 litres; excess water will drain off. When the emptying valve is shut, the entire tank volume is available.

When the stopper (Fig. 204,1) is pulled in the inside of the auxiliary water tank, the water drains away via the drain (Fig. 203,3). The stopper can be accessed via the service opening (Fig. 203,1).

Filling with water:

- Ensure that the stopper (Fig. 204,1) in the auxiliary water tank is shut (handle (Fig. 204,2) is folded out).
- Ensure that the emptying valve (Fig. 203,2) is shut.
- Add water via the drinking water filler neck until both tanks are full.

Draining water:

- Open the service opening (Fig. 203,1) in the auxiliary water tank.
- Open the emptying valve until no more water runs out.
- Access the handle (Fig. 204,2) of the stopper (Fig. 204,1) via the service opening, turn the handle to the vertical position and remove the stopper.

Draining water down to trip reserve (approx. 30 litres):

- Open the emptying valve (Fig. 203,2) on the auxiliary water tank.

10.2.3 Drinking water filler neck with cap

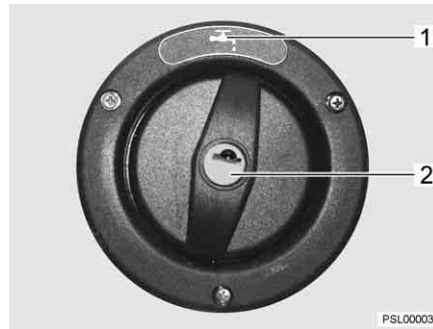

Fig. 205 Cap for the drinking water filler neck

The drinking water filler neck is on the left side of the vehicle.

The drinking water filler neck is indicated by the symbol "☞" (Fig. 205,1). The cap is open and closed using the key for the external flap locks.

- Opening:*
- Insert key into locking cylinder (Fig. 205,2) and turn a quarter turn in an anticlockwise direction.
 - Remove cap.
- Closing:*
- Place cap on the drinking water filler neck.
 - Turn key one quarter turn in a clockwise direction.
 - Remove the key.
 - Check that the cap sits firmly on the drinking water filler neck.

10.2.4 Filling the water system



- ▶ When filling the water tank, observe the maximum permissible gross weight of the vehicle. Luggage must be reduced accordingly when the water tank is full.



- ▷ The water pump will overheat without water and can get damaged. Never operate water pump when the water tank is empty.



- ▷ The Truma system (heater/boiler) has a safety/drainage valve and, depending on the model, one or two drain cocks for emptying.
- ▷ Depending on the model, the Alde system (heater/boiler) has one or two drain cocks for emptying.
- ▷ The water quantity can be monitored on the panel while the water tank is filled.

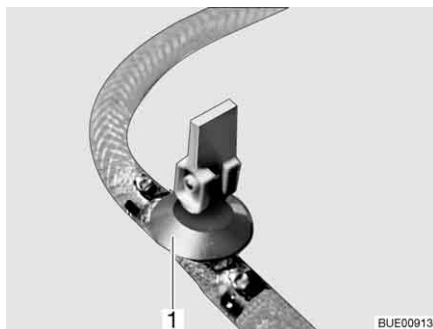

Fig. 206 Drain cock (with rocking lever)

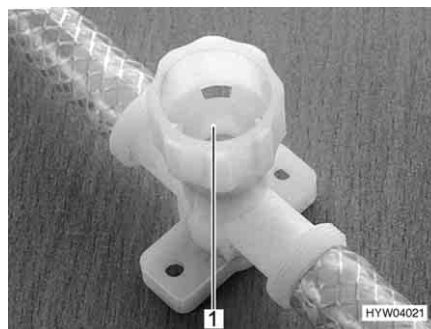

Fig. 207 Drain cock (with twist cap)

- Position the vehicle horizontally.
- Switch on 12 V power supply on the panel.
- If necessary, switch on the water pump on the panel.
- Clean or disinfect water system.
- Close the safety/drainage valve (Truma). Turn the knob perpendicular to the safety/drainage valve and press the push button in.
If the temperature is below 6 °C, the safety/drainage valve cannot be closed. Therefore switch on the living area heater and wait until the temperature of the safety/drainage valve exceeds 6 °C.
- Close all drain cocks. To do this, position the drain cock's rocking lever (Fig. 206,1) horizontally or turn the drain cock's cap (Fig. 207,1) in a clockwise direction.
- Close the drainage opening of the water tank.
- Close all water taps.
- Open the drinking water filler neck on the outside of the vehicle.
- Fill the water tank with drinking water. Use a water hose, a water canister with a funnel or similar for filling.
- Set all the water taps to "Hot" and open them. The water pump is turned on. The warm water pipes are filled with water.
- Keep the taps open until the water flowing out of the taps has no bubbles in it. This is the only way to ensure that the boiler is full of water.
- Set all water taps to "Cold" and leave them open. This will fill the cold water pipes with water.
- Keep the taps open until the water flowing out of the taps has no bubbles in it.
- Close all water taps.
- Close drinking water filler neck.
- Check that the cap on the water tank is not leaking.

**Position of the drain
cocks and safety/
drainage valve**

See chapter 16.

10.2.5 Topping up the water



- ▶ When filling the water tank, observe the maximum permissible gross weight of the vehicle. Luggage must be reduced accordingly when the water tank is full.

- Open drinking water filler neck.
- Fill the water tank with drinking water. Use a water hose, a water canister with a funnel or similar for filling.
- Close drinking water filler neck.

10.2.6 Closing/opening the overflow



- ▶ When filling the water tank, observe the maximum permissible gross weight of the vehicle. Luggage must be reduced accordingly when the water tank is full.

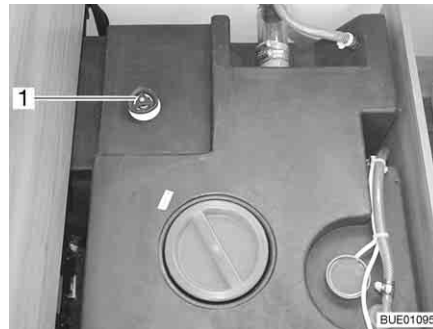

Fig. 208 Water tank with handle

- Closing:*
- Turn the handle (Fig. 208,1) on the water tank in a clockwise direction as far as it will go.
 - Fill the water tank with drinking water.
- Opening:*
- Turn the handle (Fig. 208,1) on the water tank in an anticlockwise direction as far as it will go. Excess water will drain away leaving 60 litres in the tank.

10.2.7 Draining water (handle with overflow)

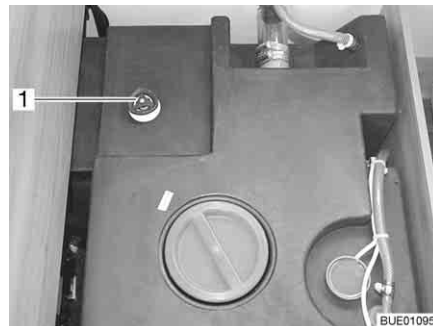

Fig. 209 Water tank with handle

- Turn the handle (Fig. 209,1) on the water tank in an anticlockwise direction as far as possible beyond the resistance to fully open the drainage opening.

10.2.8 Emptying the water system



- ▷ If the vehicle is not used for several days or if it is not heated when there is a risk of frost, empty the entire water system. Make certain that the water pump is switched off on the panel. Otherwise, the water pump will overheat and may get damaged. Leave the water taps on in central position. Leave the safety/drainage valve (if there is one) and all drain cocks open. Frost damage to appliances, frost damage to the vehicle and deposits in water-carrying components can be avoided in this way.
- ▷ If the water pump can be turned off from the panel, always turn off the water pump from the panel before you empty the water system. Otherwise the water pump runs until it overheats or the battery is empty.



- ▷ The Truma system (heater/boiler) has a safety/drainage valve and, depending on the model, one or two drain cocks for emptying.
- ▷ Depending on the model, the Alde system (heater/boiler) has one or two drain cocks for emptying.

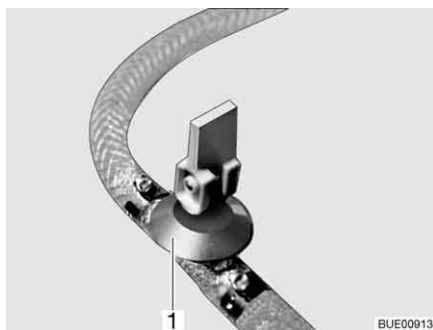

Fig. 210 Drain cock (with rocking lever)

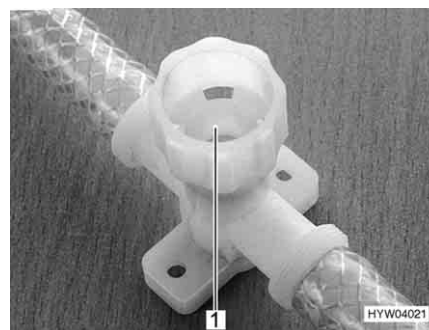

Fig. 211 Drain cock (with twist cap)

To empty and ventilate the water system, proceed as follows. This will avoid frost damage:

- Position the vehicle horizontally.
- Switch off water pump on panel.
- Switch off the 12 V power supply on the panel.
- Shut off the boiler (see section 9.4).
- Open all drain cocks. To do this, position the drain cock's rocking lever (Fig. 210,1) vertically or turn the drain cock's cap (Fig. 211,1) in an anti-clockwise direction.
- Open the safety/drainage valve (Truma). To do this turn the knob parallel to the safety/drainage valve. The push button jumps out.
- Open the water tank drain.
- Open all water taps and set to the central position.
- Hang the shower handset up in the shower position.
- Check whether the water tank is completely empty.
- Blow out the remaining water in the water pipes (max. 0.5 bar). To do this, remove the pipe from the water pump and blow into the pipe.
- Empty the waste water tank. Take note of the environmental tips in this chapter.
- Empty toilet cassette or sewage tank. Take note of the environmental tips in this chapter.
- Clean the water tank and then rinse it out thoroughly.

- Let the water system dry for as long as possible.
- After emptying, leave all water taps on in the central position.
- Leave all drain cocks open.

Position of the drain cocks and safety/ drainage valve

See chapter 16.

10.3 Waste water installation



- ▷ Never pour boiling water directly into the sink outlet. Boiling water could cause deformation and leaks in the waste water pipe system.



- ▷ Only empty the waste water tank at disposal stations, camping sites or caravan sites especially provided for this purpose.

10.3.1 Draining waste water

Waste water from the kitchen and washing unit flows through plastic pipes into the waste water tank.

The drain cock and the cleaning opening are located on the underside of the waste water tank.

The waste water tank holds 90 litres.

Drain cock in the vehicle (Argos 747-2)



- ▷ If the living area heater is out of order, the waste water tank no longer is sufficiently protected against frost. Therefore in case of frost, empty the waste water tank and leave the drain cock open or add enough anti-freeze (e.g. kitchen salt) to the waste water tank to prevent the waste water from freezing.

The waste water tank is in the double floor of the vehicle. The waste water tank can be accessed via an external flap or a cover.

The vehicle is equipped with an electrically operated drainage valve.



Fig. 212 Electrically operated drainage valve



Fig. 213 Operating switch for electrically operated drainage valve

A red line in the inspection window (Fig. 212,2) of the electrically operated drainage valve shows the valve setting:

- horizontal line = valve open
- vertical line = valve shut

- Emptying:*
- Attach the waste water hose to the drain pipe.
 - Press the operating switch (Fig. 213) at the top. The waste water is drained.
 - Completely empty waste water tank.
 - Once all the waste water has drained completely, press the operating switch (Fig. 213) at the bottom.
 - Remove the waste water hose.

- Emergency drainage:*
- Set the operating switch (Fig. 213) to the "0" position (power off).
 - Pull out the rotary knob (Fig. 212,1) on the electrically operated drainage valve and rotate (in any direction).

Drain cock underneath the vehicle (Argos Time)



- ▷ In case of frost add so much anti-freeze (such as kitchen salt) to the waste water tank so that the waste water cannot freeze.

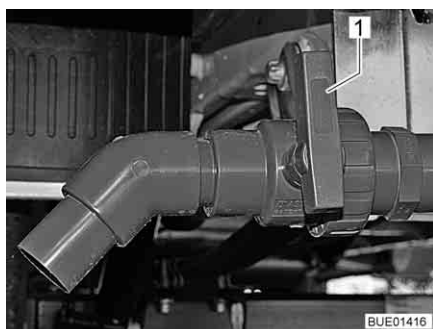

Fig. 214 Drain cock (outside)

The waste water tank is in the rear area of the vehicle. The waste water tank is located underneath the floor of the vehicle.

- Emptying:*
- Attach the waste water hose to the drain pipe. If the waste water hose is fixed in position: Remove the waste water hose from the bracket beneath the vehicle.
 - Turn the handle (Fig. 214,1) of the drain cock in flow direction. This drains the waste water through a spherical valve.
 - Completely empty waste water tank.
 - Close the drain cock handle at a right angle to the flow direction once all of the waste water has run out.
 - Remove the waste water hose. If the waste water hose is fixed in position: Fix the waste water hose to the bracket beneath the vehicle.

10.3.2 Heater for waste water tank and waste water pipes (special equipment)

In order to prevent waste water fittings freezing up, the waste water tank and the waste water pipes can be electrically heated separately.

When the heater is turned on, temperature sensors monitor the surface temperature of the waste water tank and ambient temperature of the waste water pipes. If the temperature falls below 5 °C, the heating elements are switched on and the waste water tank and waste water pipes are heated. If the temperature rises above a certain level, the heating elements are switched off again. The waste water pipes are at 7 °C, the waste water tank at 30 °C.

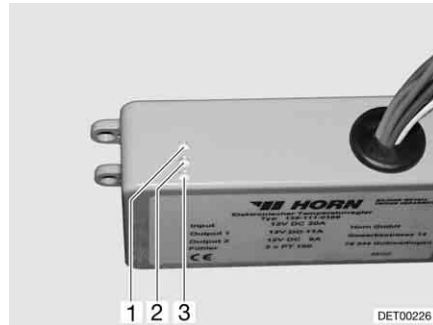

Fig. 215 Control unit



Fig. 216 Switch indicator lamps

The control unit (Fig. 215) is fitted in the wardrobe or in a bench seat. The control lamps on the control unit have the following meanings:

- Indicator lamp (Fig. 215,2) lights up in green: Regulator in operation.
- Indicator lamp (Fig. 215,1) lights up in red: Waste water tank is heated.
- Indicator lamp (Fig. 215,3) lights up in red: Waste water pipes are heated.

The on/off switch (Fig. 216) is installed at the front of the bench or bed. Press the switch up to switch on, press it down to switch off.

10.3.3 Warming unit for waste water pipes (special equipment)



- ▷ Always only press the test button briefly.



- ▷ The warming unit only functions when the vehicle is connected to a 230 V power supply.

In order to prevent waste water pipes from freezing, the waste water pipes can be electrically warmed.

When the warming unit is turned on, the temperature of the waste water pipes is monitored by temperature sensors. If the temperature falls below 5 °C, the heating elements are switched on and the waste water pipes are warmed. If the temperature rises above 7 °C, the heating elements are switched off again.

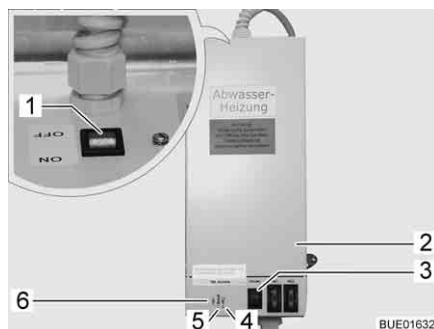

Fig. 217 Transformer with control unit

The 230 V AC/12 V DC transformer (Fig. 217,2) is installed in the wardrobe or in the storage area beneath the seating group, depending on the model.

The control unit is integrated in the transformer housing. The control lamps have the following meanings:

- Indicator lamp (Fig. 217,5) lights up in green: Regulator in operation.
- Indicator lamps (Fig. 217,4 and 6) light up in red: Waste water pipes are warmed.

A test button (Fig. 217,3) is integrated in the housing with which the control unit can be operated for a short time. By pressing the test button, the function of the warming unit can be tested, even if the ambient temperature is above 5 °C.

- Switching on:*
- Connect the vehicle to a 230 V power supply (see section 8.10.1).
 - Turn switch (Fig. 217,1) on the transformer (Fig. 217,2) to "ON".
- Switching off:*
- Turn switch (Fig. 217,1) on the transformer (Fig. 217,2) to "OFF".

10.4 Toilet compartment



- ▷ Do not transport any loads in the shower tray. The shower tray or other items of equipment in the toilet compartment can be damaged.



- ▷ For ventilation purposes during or after a shower, and for drying wet clothing, close the toilet compartment door and open the window or the toilet compartment skylight. This improves the air circulation.
- ▷ Close the shower curtain completely when showering, so that no water is able to enter the area between the wash room wall and the shower tray.
- ▷ After taking a shower, rinse soap residue from the shower tray, otherwise cracks can appear in the shower tray over time.
- ▷ After using the shower, wipe it dry to prevent moisture from collecting.
- ▷ Further information about cleaning the toilet compartment can be found in the section 11.2.

10.5 Toilet



- ▷ If there is any risk of frost and the vehicle is not heated, empty the sewage tank (cassette).
- ▷ Do not sit on the lid of the toilet. The lid is not designed to bear the weight of a person and could break.
- ▷ Use a suitable chemical for this toilet. The ventilation will merely remove the odour but not germs and gases. Germs and gases will have a detrimental effect on the sealing rubbers.
- ▷ Never put the sanitary liquid directly in the toilet bowl.
- ▷ Do not drive when the sewage tank (cassette) is more than three-quarters full, as otherwise liquid may leak from the sewage tank through the ventilation system.



- ▷ The sewage tank (cassette) can only be taken out if the sliding trap is closed.
- ▷ Further information can be obtained in the device manufacturer's instruction manual.



- ▷ Only empty the sewage tank (cassette) at disposal stations, at camping sites or caravan sites, that are especially provided for this purpose.

The flushing of the toilet is fed directly from the water system of the vehicle.

10.5.1 Preparing toilet



- ▷ The sewage tank (cassette) can only be taken out if the sliding trap is closed.

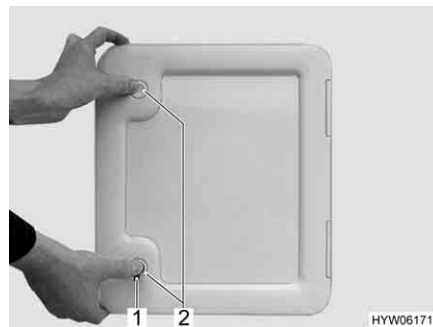

Fig. 218 Flap for sewage tank



Fig. 219 Sewage tank

- Open the flap for the sewage tank on the outside of the vehicle. Insert the key into the locking cylinder of the push-button lock (Fig. 218,1) and turn a quarter turn.
- Remove the key.
- Press both push-button locks (Fig. 218,2) simultaneously with your thumb and open the flap.
- Pull up the retaining clip (Fig. 219,3) and use the handle (Fig. 219,2) to lift the sewage tank (Fig. 219,1) straight up.
- Tilt the sewage tank slightly and remove fully.

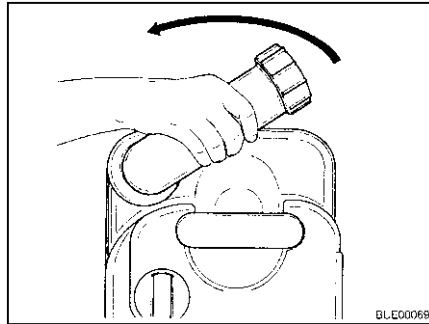

Fig. 220 Turning drainage neck

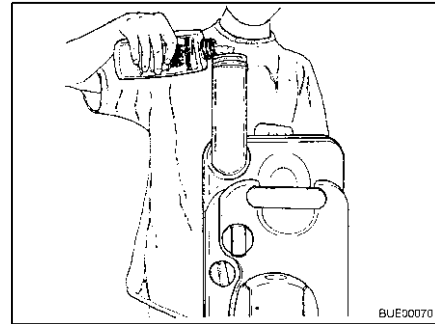

Fig. 221 Filling with sanitary liquid

- Put the sewage tank down vertically.
- Turn the drainage neck upwards.
- Remove the cap of the drainage neck.
- Fill the stated amount of sanitary liquid into the sewage tank.
- Then add enough water so that the bottom of the sewage tank is completely covered.
- Close drainage neck with the cap.
- Return the drainage neck to its original position.
- Push the sewage tank back to its original position without applying any force.
- Ensure that the sewage tank is secured by the retaining clip.
- Lock the flap for the sewage tank.

10.5.2 Swivel toilet

The flushing of the Thetford toilet is fed directly from the water system of the vehicle. The toilet bowl can be moved into the optimal position.



Fig. 222 Thetford toilet bowl, swivelling

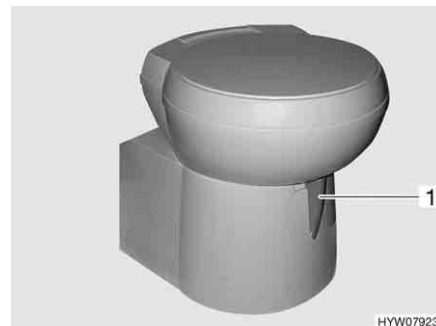

Fig. 223 Thetford toilet bowl, swivelling (alternative)

The operating unit is located close to the toilet bowl.

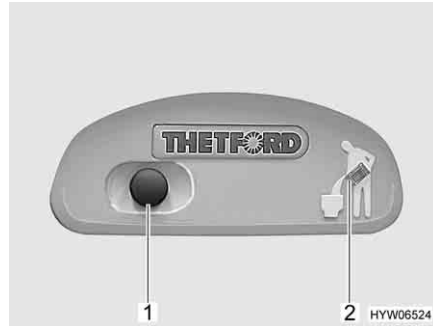

Fig. 224 Flush button/indicator lamp
Thetford toilet



Fig. 225 Flush button/indicator lamp
Thetford toilet (alternative)

Flushing:

- Before flushing open the sliding trap of the Thetford toilet. To do this, push the slide lever (Fig. 222,1 or Fig. 223,1) in an anticlockwise direction.
- For flushing, press the blue flush button (Fig. 224,1 or Fig. 225,1).
- After flushing close the sliding trap. To do this push the slide lever in a clockwise direction.

The indicator lamp (Fig. 224,2 or Fig. 225,2) lights up whenever the sewage tank has to be emptied.

10.5.3 Toilet with fixed seat

The flushing of the toilet is fed from the water system of the vehicle.

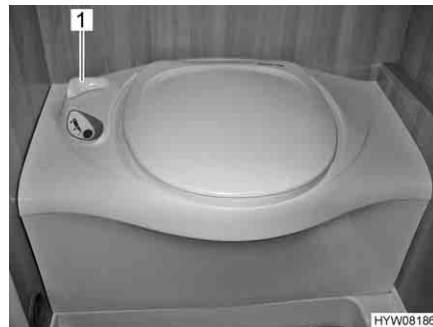

Fig. 226 Thetford toilet

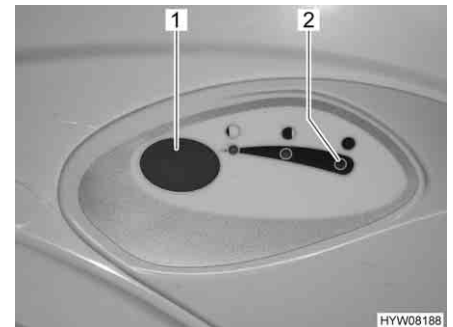

Fig. 227 Flush button/indicator lamp
Thetford toilet

Flushing:

- Before flushing open the sliding trap of the Thetford toilet. To do this, turn the slide lever (Fig. 226,1) in an anticlockwise direction.
- For flushing, press the blue flush button (Fig. 227,1).
- After flushing close the sliding trap. To do this turn the slide lever (Fig. 226,1) in a clockwise direction.

The indicator lamp (Fig. 227,2) lights up whenever the sewage tank has to be emptied.

10.5.4 Emptying the sewage tank



- ▷ The sewage tank can only be taken out if the sliding trap is closed.

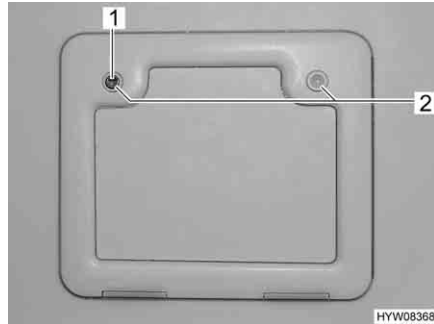

Fig. 228 Flap for the sewage tank



Fig. 229 Sewage tank

- Slide the slide lever on the toilet bowl in a clockwise direction. The sliding trap is closed.
- Open the flap for the sewage tank on the outside of the vehicle. Insert the key into the locking cylinder of the push-button lock (Fig. 228,1) and turn a quarter turn in a clockwise direction.
- Remove the key.
- Press both push-button locks (Fig. 228,2) simultaneously with your thumb and open the flap for the sewage tank.
- Pull the retaining clip (Fig. 229,1) upwards and pull out the sewage tank (Fig. 229,2).
- Completely empty the sewage tank at disposal stations that are especially provided for this purpose.



- ▷ Actuate the aeration knob on the sewage tank with your thumb to empty it completely.

Chapter overview

This chapter contains instructions regarding the care of the vehicle.

The instructions address the following topics:

- exterior of the vehicle
- interior
- water system
- extractor hood
- air conditioning unit
- winter operation

At the end of the chapter there is a checklist of measures you must carry out if you are not going to use the vehicle for an extended period of time.

The checklist address the following topics:

- temporary lay-up
- winter lay-up
- start-up after a lay-up

11.1 External care

11.1.1 General

Standard external care consists of regular washing. The use and the environmental conditions will determine how often the vehicle needs to be washed. Wash the vehicle more frequently in areas which are exposed to heavy air pollution or heavy traffic or roads treated with de-icing salts. If the vehicle is exposed to salty and humid air (coastal areas, humid climates), wash the vehicle more frequently.

Do not park under trees if at all possible. The resin-like discharge which many trees secrete, give the paintwork a matt look and can promote the onset of corrosion.

Wash off bird droppings straight away and thoroughly, as the acid it contains is extremely corrosive.

11.1.2 Washing with a high-pressure cleaner



- ▷ Do not clean the tyres with a high-pressure cleaner. The tyres might be damaged.
- ▷ Do not spray external applications (deco-films) directly with the high-pressure cleaner. The external applications could come off.

Before cleaning the vehicle with a high-pressure cleaner, observe the operating instructions of the high-pressure cleaner.

When cleaning with the nozzle for circular jet between the vehicle and the cleaning nozzle, maintain a minimum distance of approx. 700 mm.

Take into consideration that the jet of water comes out of the cleaning nozzle with pressure. The vehicle may be damaged by incorrect handling of the high-pressure cleaner. The temperature of the water should not be above 60 °C. Keep the jet of water in constant movement during the washing process. Do not direct the water jet at clearances, built-in electrical parts, plugs, seals, the ventilation grill or the skylights. The vehicle may be damaged or water may enter the interior.

11.1.3 Washing the vehicle



- ▷ Never clean the vehicle in the car wash. Water can enter the refrigerator grills, the waste gas vents, the ventilation of the extractor hoods or the forced ventilations. The vehicle could be damaged.
- Wash the vehicle only on a washing site intended for this purpose. Avoid full sunshine. Observe environmental measures.
- Only clean external applications and synthetic parts with plenty of warm water, dish washing liquid and soft cloth.
- Wash down the vehicle with plenty of water, a clean sponge or a soft brush. In the case of stubborn dirt add dish washing liquid to the water.
- Painted exterior walls may also be cleaned with a caravan cleaner.
- Add-on parts made of glass-fibre reinforced plastic (GRP) require a regular follow-up treatment with a polisher. This way these parts will not turn yellow and the sealing of the surface remains intact.
- Treat rubber seals of doors and storage flaps with talc.
- Treat locking cylinder of doors and storage flaps with graphite dust.

11.1.4 Windows of acrylic glass



Acrylic glass windows are delicate and require very careful handling.

- ▷ Never rub acrylic glass windows dry as dust particles might damage the surface!
- ▷ Only clean acrylic glass windows with plenty of warm water, some dish washing liquid and a soft cloth.
- ▷ Never use glass cleaning agents with chemical, abrasive or alcohol-containing additives. Premature brittleness of the panes and associated cracks may result from their use.
- ▷ Avoid contact of cleansing agents used for the body (e.g. tar- or silicone-removing agents) with acrylic glass.
- ▷ Do not clean vehicle in car wash.
- ▷ Do not attach stickers to the acrylic glass windows.
- ▷ Having cleaned the vehicle rinse acrylic glass with sufficient clear water.
- ▷ Apply talcum powder to rubber seals.



- ▷ An acrylic glass cleanser with antistatic effect is suitable for a follow-up treatment. Small scratches can be treated with an acrylic glass polish. These agents are available at the accessories shop.

11.1.5 Underbody

The underbody of the vehicle is partly coated with an age-resistant underbody protection. Should the underbody protection be damaged, repair immediately. Do not treat areas coated with underbody protection with spray oil.



- ▷ Only use products approved by the manufacturer. Our authorised dealers and service centres will be happy to advise you.

11.1.6 Entrance step

If the entrance step is lubricated, coarse particles of dirt can settle on the lubricant during the journey and cause damage to the operating mechanism of the entrance step. Therefore, do not lubricate the moving parts of the entrance step.

11.1.7 Pneumatic spring



- ▷ Never clean the individual parts of the pneumatic spring with steam or high-pressure cleaners, abrasive or organic solvents.

Clean the pneumatic spring bellows, air duct and shock absorber regularly. Use soapy water, methanol, ethanol or isopropyl alcohol for cleaning.

11.2 Interior care



- ▷ If possible, treat stains immediately.
- ▷ Acrylic glass windows are delicate and require very careful handling (see section 11.1.4).
- ▷ Synthetic parts in the toilet and living area are very delicate and should be treated with care. Do not use solvents, alcohol-containing cleansers or scourers. This procedure will help you to avoid brittleness and formation of cracks.
- ▷ Hair colourants, nail varnish, cigarette ash and similar substances may cause permanent stains or discolouration. For this reason, you should prevent these substances from getting onto plastic parts. If they do get onto plastic parts, you should remove these substances immediately.
- ▷ Do not pour any corrosive agents into the drain holes. Never pour boiling water directly into the drain holes. Corrosive agents and boiling water cause damage to drainage pipes and siphon traps.
- ▷ Do not use vinegar based products to clean the toilet and water system, or for decalcification of the water system. Vinegar-based products may cause damage to seals or parts of the installation. Use standard decalcifying products for decalcification.
- ▷ Save water. Mop up all remaining water.
- ▷ Vacuum off carpets and cushions with a suitable brush attachment.



- ▷ For information about the use of maintenance products, our representatives and service centres will be glad to advise.
- Surface and knobs of furniture, lamps and synthetic parts in the toilet and living area should be cleaned with water and a wool cloth. A mild cleanser may be added to the water. If required, use furniture polish for the painted surfaces.
- Clean upholstery with dry foam specially manufactured for the use on upholstery or with the foam of a mild detergent. Do not wash upholstery. Always have it cleaned. Protect upholstery from direct sunlight so that it does not lose its colour.
- Clean upholstery made of novalife® with clear water only.

- Leather covers should be cleaned with a cotton cloth and a mild soap (curd soap). Make sure that the leather is not soaked through and that no water seeps through the seams of the leather covers.
- Wash panel curtains and gathered blinds. When washing observe washing instructions on the product. The sticks may be removed for washing.
- Vacuum clean the carpet, if necessary clean with carpet shampoo.
- Clean PVC-floor covering with a mild, soapy cleanser for PVC floors. Do not place carpet on wet PVC-floor covering. The carpet and the PVC-floor covering may stick together.
- Never clean the sink or the gas cooker with a scourer. Avoid anything which may cause scratching or grooves.
- Clean the burners on the gas cooker using a damp cloth only. Prevent any water from penetrating the burner covers. Water may damage the burners on the gas cooker.
- Brush insect screens on doors, windows and skylights with a soft brush or vacuum with the brush attachment of the vacuum cleaner.
- Brush blinds with a soft brush or vacuum with the brush attachment of the vacuum cleaner. Grease or stubborn dirt may be removed with a mild soap at 30 °C (curd soap).
- Brush Roman shades with a soft brush or vacuum with the brush attachment of the vacuum cleaner. Grease or stubborn dirt may be removed with a mild soap at 30 °C (curd soap).
- Unrolled seat belts can be cleaned with warm soapsuds. The seat belt must be completely dry before being rolled up.
- Wipe the fuel cell with a soft, damp cloth.

11.3 Water system

11.3.1 Cleaning the waste water tank

Clean the waste water tank after every use.

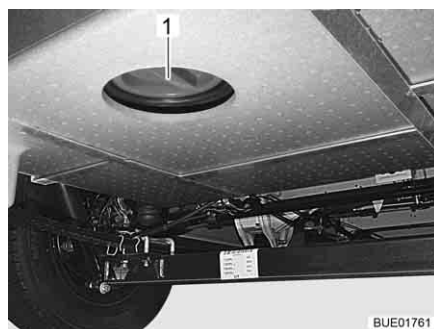

Fig. 230 Cleaning opening on the waste water tank

- Empty the waste water tank.
- Open the cleaning opening (Fig. 230,1) on the waste water tank and the drain cock.
- Thoroughly rinse out the waste water tank with fresh water.
- If possible, clean waste water sensors through the cleaning opening by hand.

11.3.2 Cleaning the water tank

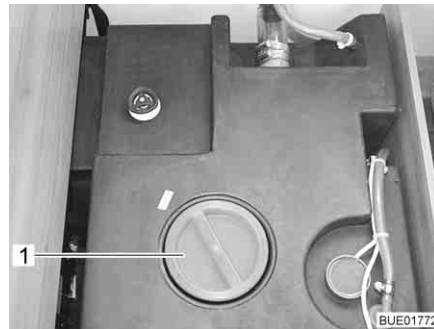

Fig. 231 Water tank with handle

- Empty the water tank and close the drainage opening.
- Remove the cap (Fig. 231,1) of the water tank.
- Fill water tank with water and some washing-up liquid (do not use any scourers).
- Using a trade standard brush for washing dishes, scrub the water tank until there is no longer any visible deposit.
- If possible, clean fresh water sensors through the cleaning openings by hand.
- Rinse water tank with copious amounts of drinking water.

11.3.3 Cleaning the water pipes



- ▷ Only use suitable cleaning agents as sold by the specialist trade.
- ▷ The cleaning agent must meet national regulations and be approved (if required).



- ▷ Collect any emerging mixture of water and cleaning agent for correct disposal.

- Empty the water system.
- Close all drain holes and drain cocks.
- Fill mixture of water and cleaning agent into the water tank. Observe the manufacturer's instructions regarding the mixing ratio.
- Open the drain cocks one by one.
- Leave the drain cocks open until the mixture of water and cleaning agent has reached the respective drain.
- Close the drain cocks.
- Set all the water taps to "Hot" and open them.
- Leave the water taps open until the mixture of water and cleaning agent has reached the drain.
- Set all water taps to "Cold" and open them.
- Leave the water taps open until the mixture of water and cleaning agent has reached the drain.
- Close all water taps.
- Flush the toilet several times.

- Allow the cleaning agent to act in accordance with the manufacturer's instructions.
- Empty the water system. Collect the mixture of water and cleaning agent for correct disposal.
- For rinsing fill the entire water system with drinking water and empty again several times over.

11.3.4 Disinfecting the water system



- ▷ Only use suitable disinfectants as sold by the specialist trade.
- ▷ The disinfectant must meet national regulations and be approved (if required).



- ▷ Collect any emerging mixture of water and disinfectant for correct disposal.

When disinfecting the water system, proceed the same way as when cleaning the water pipes (see section 11.3.3). Simply use disinfectant instead of cleaning agent.

11.4 Extractor hood

Clean the extractor hood filter occasionally. How often cleaning is necessary depends on how often the extractor hood is used. Do not wait to clean the filter until the performance of the extractor hood has noticeably decreased.

Cleaning the filter:

- Wash the filter with warm water and some washing-up liquid.

11.5 Air conditioning unit

11.5.1 Dometic



Fig. 232 Air conditioning unit (Dometic)

A lint filter and an activated carbon filter are each located in the lower part of the air conditioning system ceiling unit (Fig. 232,2) behind the ventilation grills (Fig. 232,1 and 3). The lint filters must be cleaned at regular intervals and replaced if necessary. The manufacturer recommends replacing the activated carbon filter yearly.

On the left side of the ceiling unit (outside of the vehicle) is located the drainage opening for the condensation. Keep the drain openings free from dirt, leaves or similar to allow the condensation to be drained.

11.5.2 Telair

Every now and then clean the filter and the ventilation grilles on the outside of the housing. How often cleaning is necessary depends on how often the air conditioning unit is used. Do not wait to clean the filter and the ventilation grill until the performance of the air conditioning unit has noticeably decreased.



- ▷ Only use mild cleaning solutions to clean the filter, never use benzene or solvents.

Cleaning the filter:

- Wash the filter with warm water and some washing-up liquid.
- Allow the filter to dry thoroughly before reassembly.

Cleaning the ventilation grill:

- Use a brush to remove coarse dirt or deposits from the external ventilation grilles. If a cleaning solution is used, ensure that no water ingresses into the inside of the housing.

11.6 Winter care

De-icing salt damages the underbody and the parts open to water spray. We recommend that you wash the vehicle more frequently during wintertime. Mechanical and surface treated parts and the underside are under particular strain, and should therefore be cleaned thoroughly.



- ▷ If there is any risk of frost, always run heater at a minimum of 15 °C. Switch the circulation fan (if there is one) to automatic. In the case of extreme external temperatures, the furniture flaps and doors should be left slightly open. The inflowing warm air can help prevent the freezing of water pipes, for example, and counteract the formation of condensation in the storage spaces.
- ▷ If there is any risk of frost, cover the outside surface of the windows with winter insulation mats.
- ▷ Keep waste gas vents and forced ventilations free of snow. Use a vent extension, if necessary.

11.6.1 Preparations

- Check the vehicle for paint and rust damage. Repair damage as necessary.
- Make certain that water cannot penetrate the automatic floor ventilation system and the heater.
- Use a wax-based rust inhibitor to protect the metal parts of the underbody.
- Use appropriate protection for external painted surfaces.

11.6.2 Winter operation

During winter operation, condensation develops when the vehicle is occupied under low-temperature conditions. To ensure good interior air quality and avoid vehicle damage from condensation, sufficient ventilation is essential.

- When heating the vehicle, the heater should be at the highest setting and roof storage cabinets, curtains and blinds should be opened. This ensures optimal ventilation.
- Only heat if the circulation system is switched on.
- In the morning, lift up all cushions, air out storage boxes and dry any damp areas.



- ▷ If condensation has still developed, just wipe it off.
- ▷ It is only possible to guarantee unrestricted operation during winter for models without double floor in connection with the "winter package" from the original equipment.

11.6.3 At the end of the winter season

- Thoroughly clean the underbody of the vehicle and the engine. When this is done, corrosion-inducing anti-freeze agents (salts, alkaline residues) are removed.
- Clean the exterior and use regular car wax to protect metal surfaces.

11.7 Lay-up

11.7.1 Temporary lay-up



- ▶ If the vehicle has been stationary for a long period (approx. 10 months) have the braking and gas systems checked by an authorised specialist workshop.
- ▶ Take into consideration that water is undrinkable after only a short time.
- ▶ Animal damage to cables can lead to short circuits. Fire hazard!

Before laying up the vehicle, go through the following checklist:

Base vehicle

Activities	Done
Completely fill fuel tank. This prevents corrosion damage within the fuel tank system	
Jack up vehicle so that the wheels do not bear any load, or move vehicle every 4 weeks. This prevents any pressure points from occurring on tyres and wheel bearings	
Protect the tyres from direct exposure to the sun. Danger of formation of cracks!	
Inflate tyres up to the recommended maximum pressure	
Always provide for sufficient ventilation in the underbody area	
▷ Humidity or lack of oxygen e.g. by covering with plastic film may cause optical irregularities to the underbody.	
In addition observe the notes in the operating manual of the base vehicle	

	Activities	Done
Body	All vents should be sealed with the appropriate caps and all other openings (apart from forced ventilations) should also be sealed. This prevents animals (e.g. mice) from gaining entry	
	Air the interior, all storage compartments accessible from the outside, and the parking space (e.g. garage) every 3 weeks in order to prevent the occurrence of condensation and resulting mould formation	
Interior	Place upholstery in an upright position for ventilation, and cover	
	Clean refrigerator	
	Allow refrigerator and freezer compartment doors to remain slightly open	
	Search for traces of animals that have gained entry	
	Disconnect the flat screen from the mains and, if necessary, remove it from the vehicle	
Gas system	Close regulator tap on the gas bottle	
	Close all gas isolator taps	
	Always remove gas bottles from the gas bottle compartment, even if they are empty	
Electrical system	Fully charge living area and starter battery	
	 ▷ Charge the battery for at least 20 hours before laying up.	
	Disconnect the living area battery from the 12 V power supply. In order to do this switch off the battery cut-off switch on the transformer/rectifier or activate the battery separation via the panel (see chapter 8)	
Water system	Empty the entire water system. Blow out the residual water from the water pipes (0.5 bar max.). Leave the water taps on in central position. Leave the safety/drainage valve (if there is one) and all drain cocks open. Observe the notes in chapter 10	

11.7.2 Winter lay-up

Additional measures are required if laying up the vehicle over winter:

	Activities	Done
Base vehicle	Clean body and underbody thoroughly and spray with hot wax or protect with varnish	
	Fill fuel tank with winter diesel	
	Check antifreeze in the cooling water	
	Rectify damage to the paintwork	
Body	Clean vehicle from outside thoroughly	
	Keep the forced ventilation open	
	Clean and grease installed supports	
	Clean and grease all door and flap hinges	
	Brush oil or glycerine on all locking mechanisms	
	Rub all rubber seals with talc	
	Use graphite dust to treat locking cylinders	
Interior	Position de-humidifiers	
	Remove upholstery from the vehicle and store in a dry place	
	Air the interior every 3 weeks	
	Empty all cabinets and storage compartments, open flaps, doors and drawers	
	Thoroughly clean the interior	
	If there is a risk of frost, do not leave the flat screen in the vehicle	
Electrical system	Remove the starter battery and the living area battery and store them in a place protected from frost (see chapter 8) or connect the vehicle to a 230 V supply	
Water system	Clean the water system using a cleaning agent from a specialised store	
Complete vehicle	Arrange the tarpaulins in such a way that the ventilation openings are not covered, or use porous tarpaulins	

11.7.3 Starting up the vehicle after a temporary lay-up or after lay-up over winter

Go through the following checklist before start-up:

	Activities	Done
Base vehicle	Check the tyre pressure on all tyres	
	Check the tyre pressure of the spare wheel	
Body	Clean the pivot bearing of the entrance step	
	Check the functioning of the fitted supports	
	Check that the doors, windows and skylights are working properly	
	Check that all the external locks are working, such as the external flaps, the filler neck and the conversion door	
	Remove the cover from the waste gas vent of the heater (if there is one)	
	Remove the winter cover from the refrigerator grills (if there is one)	
Gas system	Put the gas bottles in the gas bottle compartment, tie down and connect to the gas pressure regulator	
Electrical system	Connect to 230 V power supply using the external socket	
	Fully charge living area and starter battery	
	 ▷ Charge the battery for at least 20 hours after lay-up.	
	Connect the living area battery with the 12 V power supply. In order to do this switch on the battery cut-off switch on the transformer/rectifier or deactivate the battery separation via the panel (see chapter 8)	
	Check that the electrical system are working, e.g. interior light, socket and all installed electrical appliances	
Water system	Disinfect water pipes and water tank	
	Check the functionality of the operating lever for the waste water tank	
	Close safety/drainage valve (if there is one), drain cocks and water taps	
	Check water system for leaks	
Appliances	Check the function of the appliances	
	Change heating fluid of the hot-water heater every 2 years	

Chapter overview

This chapter contains instructions about inspection and maintenance work concerning the vehicle.

The maintenance instructions address the following topics:

- doors
- living area battery
- fuel cell
- Alde hot-water heater
- independent vehicle heater
- replacing light bulbs
- AL-KO rear axle

At the end of the chapter you will find important instructions on how to obtain spare parts.

12.1 Inspection work

Like any technical appliance, the vehicle must be inspected at regular intervals.

This inspection work must be carried out by qualified personnel.

Special technical knowledge, which cannot be taught within the framework of this instruction manual, is required for these tasks. Personnel possessing this technical knowledge are available for assistance at all our service centres. Their experience and regular technical instruction by the factory as well as equipment and tools guarantee expert and up-to-date inspection of the vehicle.

Have the "First Programmed Inspection" carried out at one of our service centres 12 months after initial registration.

Further inspections should be carried out once a year.

The service centre in charge will confirm the work performed.

Have chassis inspections confirmed in the chassis manufacturer's customer service booklet.



- ▷ Observe the inspections indicated by the manufacturer and have them carried out at the specified intervals. The value of the vehicle is thus preserved.
- ▷ The confirmation of the inspection work carried out serves as valid proof in the event of damage and guarantee claims.

12.2 Maintenance work

As with every machine, this vehicle requires maintenance. The extent and frequency of the maintenance work required depend on conditions of operation and use. More difficult operating conditions make it necessary to service the vehicle more often.

Have the base vehicle and the appliances serviced at the intervals specified in the corresponding instruction manuals.

12.3 Doors

To maintain gliding capability between springs and hinges, grease the conversion door hinges occasionally.



- ▷ We recommend either Molykote PG 65 or Vaseline as lubricants.

12.4 Living area battery



- ▷ When replacing the battery, only use the same type of battery (same capacity and voltage, cycle stability).
- ▷ Never use conventional car batteries (starter batteries). A lead acid battery must not be replaced by a dryfill battery.
- ▷ Do not use so-called improvers.

Observe the following to extend battery life:

- Keep the battery surface clean and dry.
- Check the acid level periodically and top up with desalinated or distilled water as necessary. Never top up with acids.
- If water loss is considerable, have the controller voltage checked by an authorised specialist workshop.
- Use an acid density measurement to check the battery's charging condition.

Acid density

- The battery must be recharged if the acid density falls below 1.21 kg/l. If battery acid with a density of 1.23 kg/l is used, the battery must be recharged when the acid density falls below 1.18 kg/l.
- With acid density of 1.21 kg/l, the battery is protected against freezing at temperatures up to -15 °C (at 1.28 kg/l up to -70 °C).

The battery has cycle stability and is thus particularly suited for vehicle power supply. Cycle stability means that several discharge/charging processes are possible.

12.5 Fuel cell

12.5.1 Replacing the tank cartridge



- ▶ When changing tank cartridges, do not smoke and avoid unshielded flames. Fire hazard!
- ▶ Methanol is toxic. Avoid inhaling, swallowing or any contact with the skin or the eyes.



- ▷ When connecting the tank, make sure that the tank hose has no kinks and that it is not squashed.
- ▷ Only use original SFC tank cartridges.



- ▷ The tank cartridge may only be replaced if the system is running.
- ▷ Any methanol emerging will evaporate without residue.
- ▷ Original tank cartridges are available from all authorised dealers and service centres.

- Unscrew the tank cartridge connection from the empty tank cartridge.
- Loosen the securing belt on the tank cartridge.
- Remove empty tank cartridge from the tank cartridge holder.
- After use, firmly close the cap of the tank cartridge.
- Insert a new, sealed original tank cartridge into the tank cartridge holder.
- Secure the tank cartridge with the securing belt.
- Open cap and keep safe.
- Screw tank cartridge connection onto the new tank cartridge.
- In the "Main Menu > Fuel Cartridge" menu, specify the tank cartridge size used and confirm with "OK".

12.5.2 Refilling service fluid



- ▷ Only use original SFC refill sets.
- ▷ Only replenish service fluid if a message to do so appears on the operating panel.
- ▷ Ensure that no dirt or foreign bodies enter the filling hole.



- ▷ Original refill sets are available from all authorised dealers and service centres.
- ▷ Wipe up any spilled service fluid with a cloth.
- Turn off fuel cell and remove the device's connector plug.
- Remove the air discharge hose.
- Cut off the tip of the nozzle on the refill bottle.
- Pour the entire content of the refill bottle into the connection for the air discharge hose.
- Re-insert the air discharge hose.
- Plug the device's connector plug back on again.
- Press the reset button.

12.6 Alde hot-water heater



- ▷ Check the level of the heating fluid regularly on the compensator reservoir.
- ▷ During or after the first operating hours of the hot-water heater, the filling level may fall below the minimum mark. If this is the case, top up the heating fluid.
- ▷ We recommend to bleed the heating system after the initial heater operation and to check the glycol content.
- ▷ Have heating fluid changed by an authorised dealer or a service centre at intervals of approximately two years as corrosion-protection wears off after some time.
- ▷ Top up heating system with a water-glycol mixture (60 : 40) only. This mixture offers frost protection up to approx. -25 °C. When topping up hot-water heaters that are connected to the engine's cooling circuit, please observe the instructions in the instruction manuals of the manufacturers.



- ▷ Further information can be obtained in the device manufacturer's instruction manual.

12.6.1 Checking the fluid level



Fig. 233 Compensator reservoir with panel



Fig. 234 Compensator reservoir without panel

- Switch off the hot-water heater and allow it to cool down.
- Check if the fluid level is between the marks "MIN" (Fig. 233,3 or Fig. 234,3) and "MAX" (Fig. 233,2 or Fig. 234,2) on the compensator reservoir (Fig. 233 or Fig. 234).

12.6.2 Topping up heating fluid

- Position the vehicle horizontally. This prevents the formation of bubbles.
- Switch off the hot-water heater and allow it to cool down.
- If necessary, unscrew or remove the panel (depending on the model).
- Open the rotary lid (Fig. 233,1 or Fig. 234,1) on the compensator reservoir.
- Remove cover.
- Check anti-freeze with an anti-freeze hydrometer. The frost protection content must be 40 % or correspond to a frost protection of -25 °C.
- Fill water frost protection mixture slowly into the compensator reservoir.



- ▷ The optimum fluid level is reached when the fluid in the compensator reservoir is 1 cm above the "MIN" mark when it is cooled down.

12.6.3 Bleeding the heating system



Fig. 235 Bleeding valve of hot-water heater

The bleeding valves are built in nearby the radiators.

For position of the bleeding valves, see also table "Position of the bleeding valves".

- Switch off the hot-water heater and allow it to cool down.
- Open bleeding valve (Fig. 235,1) and leave open until no more air escapes.
- Close bleeding valve.
- Repeat this procedure at all bleeding valves.
- Check to see if the hot-water heater warms up.

12.6.4 Position of the bleeding valves

A 747-2

Position of the bleeding valves
Drain for complete emptying under the garage flap under the vehicle at the right
On the overcab bed, right and left
In the seating group away from the direction of travel, access via the bench seat cover
In the divan in the front area, access via the service flap
In the cabinet at the left access
In the bathroom on the radiator
On the rear bed, left and right
In the kitchen behind the drawer
In the rear to the right, access via the garage flap

12.7 Independent vehicle heater

Use the independent vehicle heater for 10 minutes at least once a month with a cold engine and smallest fan settings.

Before the heating season starts, have the independent vehicle heater checked by an authorised specialist workshop.

12.8 Replacing bulbs, external



- ▶ Bulbs and light fittings can be extremely hot. Therefore, allow lights to cool down before changing bulbs.
- ▶ Store bulbs in a safe place inaccessible to children.
- ▶ Do not use any bulb that has been dropped or which shows scratches in its glass. The bulb might burst.



- ▷ A new bulb should not be touched with the fingers. Use a cloth when installing the new bulb.
- ▷ Use only bulbs of the same type and with the correct wattage (see section 12.8.4 "Types of bulbs for exterior lighting").
- ▷ If LEDs in lights are defect, contact an authorised dealer or service centre.

Types of bulbs

Different types of bulbs are used in the vehicle. Below, we have described how to change the different types of bulbs.

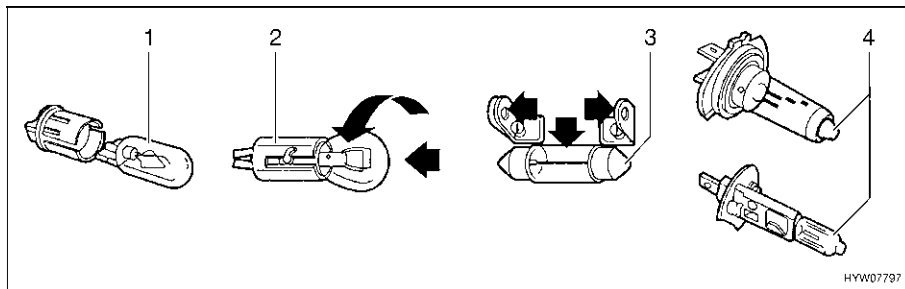

Fig. 236 Types of bulbs

Pos. in Fig. 236	Fixture type/bulb type	Changing
1	Plug-in fixture	To remove, pull out the bulb To mount, push the bulb into the socket with gentle pressure
2	Bayonet socket	To remove, press the bulb down and turn in an anticlockwise direction To insert, place the bulb in the socket and turn in a clockwise direction
3	Cylindrical bulbs	To remove and to insert, carefully bend the contacts of the lamp holder outwards
4	Halogen bulb	To remove, release retaining springs After inserting, hook the retaining springs again

12.8.1 Front lights

The lamps for low beam, main beam and parking light as well as for the direction indicator are part of the basic vehicle. Replacement of light bulbs is described in the instruction manual of the base vehicle.

12.8.2 Rear lights

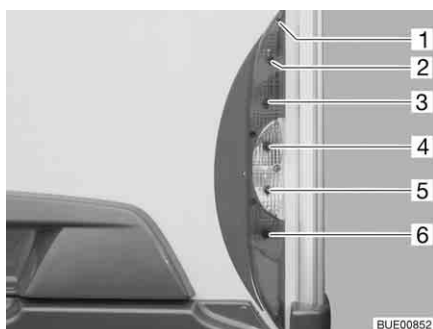

- 1 Housing screws
- 2 Rear light
- 3 Brake light
- 4 Direction indicator
- 5 Reverse light
- 6 Fog tail light

Fig. 237 Rear lights

- Undo the five housing screws (Fig. 237,1).
- Remove housing.
- Remove bulb.

- Put in a new bulb.
- Reassemble the lamp in the reverse order.

12.8.3 Side lights

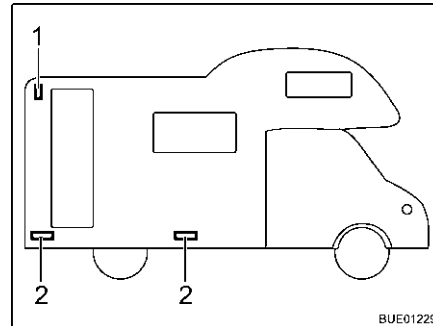

- 1 Side marker light
- 2 Marker light

Fig. 238 Side lights

Side marker light The side marker light is fixed in the rear area at the top.

Marker lights The marker lights are fitted in the lower part of the vehicle. Depending on the length of the vehicle, there may be 2 or 3 marker lights.



- ▷ The lights have LEDs. To change the LEDs, contact an authorised dealer or a service centre.

12.8.4 Types of bulbs for exterior lighting

	Exterior lighting	Type of bulb
Rear	Brake light	Ba15s 12 V 21 W
	Rear light	Ba15s 12 V 5 W
	Direction indicator	Ba15s 12 V 21 W orange
	Fog tail light	Ba15s 12 V 21 W
	Licence plate light	LED
	Reverse light	Ba15s 12 V 21 W
	Third brake light	LED
Side	Marker light	LED
	Side marker light	LED

12.9 Replacing bulbs, internal



- ▶ Bulbs and light fittings can be extremely hot. Therefore, allow lights to cool down before changing bulbs.
- ▶ Shut off the power supply on the safety cut-out in the 230 V fuse box before changing bulbs.
- ▶ Store bulbs in a safe place inaccessible to children.
- ▶ Do not use any bulb that has been dropped or which shows scratches in its glass. The bulb might burst.
- ▶ Halogen lamps can get very hot. When the light is switched on, there must always be a safety distance of 30 cm between light and flammable objects. Fire hazard!
- ▶ Do not replace the LEDs in lamps with standard light bulbs. Risk of fire due to intense heat build up.



- ▷ A new bulb should not be touched with the fingers. Use a cloth when installing the new bulb.
- ▷ Only use bulbs of the same type and with the correct wattage.
- ▷ If LEDs in lights are defect, contact an authorised dealer or service centre.

12.9.1 Halogen ceiling lamp

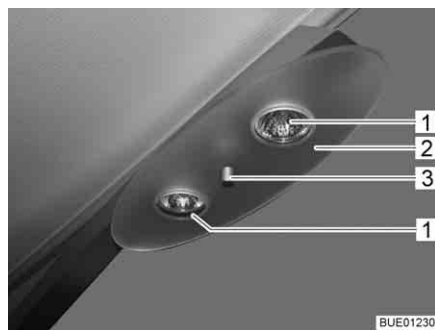

Fig. 239 Halogen ceiling lamp

Halogen bulb 12 V/10 W

Changing bulbs:

- Unscrew retaining nut (Fig. 239,3) and remove cover plate (Fig. 239,2).
- Remove halogen bulb (Fig. 239,1).
- Put in a new halogen bulb.
- Reassemble the lamp in the reverse order.

12.9.2 Surface-mounted LED light



Fig. 240 Surface-mounted LED light



▷ LED lamps have a very long life. It is not normally necessary to replace a lamp.

Changing bulbs: ■ Contact a dealer or service centre.

12.9.3 Recessed lights with LED

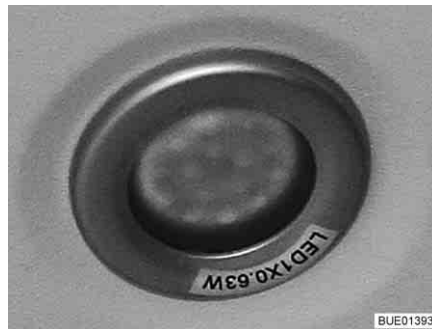

Fig. 241 Recessed LED light



Fig. 242 LED light with switch



▷ LED lamps have a very long life. It is not normally necessary to replace a lamp.

Changing bulbs: ■ Contact a dealer or service centre.

12.9.4 Recessed halogen light (flat)



Fig. 243 Recessed halogen light (flat)

Halogen bulb G4 12 V/10 W

The recessed halogen light (Fig. 243,2) is installed flush with the panel.

Changing bulbs:

- Use a suitable tool (e.g. a screwdriver) to lever out the internal cover ring with glass disk (Fig. 243,1) from the housing.
- Remove halogen bulb.
- Put in a new halogen bulb.
- Reassemble the lamp in the reverse order.

12.9.5 Halogen spotlight (movable)

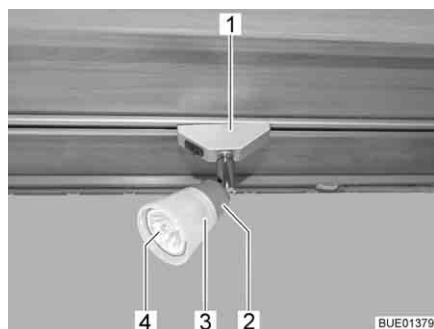

Fig. 244 Halogen spotlight (movable)



Fig. 245 Suction cup for replacing the lamp

Halogen bulb 12 V/10 W

Changing bulbs:

- Turn the halogen spotlight (Fig. 244,1) by 90° and remove from rail.
- Turn the lamp shade (Fig. 244,3) in an anticlockwise direction.
- Withdraw lamp shade complete with halogen bulb (Fig. 244,4) carefully from the holder (Fig. 244,2).
- Remove halogen bulb.
- Screw lamp shade onto holder.
- Insert new halogen spot light into the lamp shade and press into holder.
- Insert halogen lamp into the rail.



- ▷ A suction cup (Fig. 245,1) is included to help with changing the lamp.

12.9.6 Wardrobe light

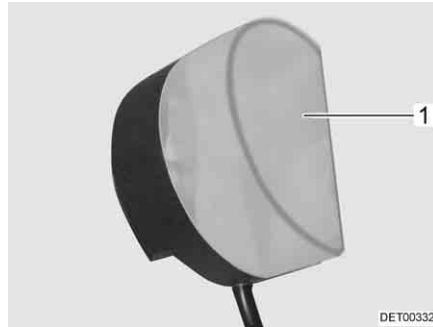

Fig. 246 Wardrobe light

Halogen bulb 12 V/8 W

- Changing bulbs:*
- Press the light covering (Fig. 246,1) lightly together and remove it.
 - Remove halogen bulb.
 - Put in a new halogen bulb.
 - Reassemble the lamp in the reverse order.

12.9.7 Surface mounted light

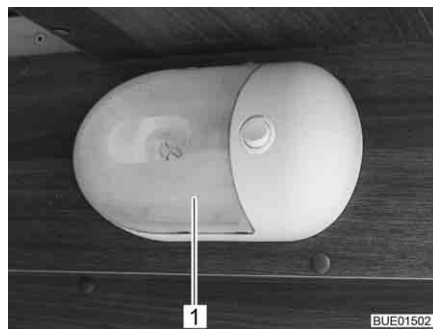

Fig. 247 Surface mounted light

12 V/16 W halogen bulb

- Changing bulbs:*
- Carefully push the transparent cover (Fig. 247,1) together from both sides, pull it lightly from the switch and pull it off forwards.
 - Remove halogen bulb.
 - Put in a new halogen bulb.
 - Reassemble the lamp in the reverse order.

12.9.8 AL-KO rear axle

Fiat vehicles with AL-KO rear axle without pneumatic spring



- ▷ In addition to the regulations and notes in the operator manual of the basic vehicle as well as in the maintenance manual, the rear axles must be relubricated after 20,000 km, or at least every 12 months.
- ▷ The rear axles must not bear any load while they are being lubricated.
- ▷ Use one of the following types of grease for lubrication:
 - Costrac GL 1501 by the firm Klüber
 - Cardex 3746 SP by the firm CONDA



- ▷ If the vehicle is equipped with a maintenance-free torsion bar spring axle or a rear axle with pneumatic cushioning, the two lubricator nipples are left out.



Fig. 248 AL-KO rear axle

The lubricator nipples (Fig. 248, arrow) are situated on the underside of the axle tube.

12.9.9 Spare parts



- ▶ Every alteration of the original condition of the vehicle can alter road behaviour and jeopardize road safety.
- ▶ The special equipment and original spare parts recommended by us have been specially developed and supplied for your vehicle. These products are available at the authorised dealer or service centre. The authorised dealer or service centre is informed about admissible technical details and carries out the required work correctly.
- ▶ The use of accessories, parts and fittings not supplied by us may cause damage to the vehicle and jeopardize road safety. Even if an expert's report, a general type approval or a design certification exists, there is no guarantee for the proper quality of the product.
- ▶ No liability can be assumed for damage caused by products which have not been released by us. This also applies to impermissible alterations to the vehicle.

For safety reasons, spare parts for pieces of equipment must correspond with manufacturer's instructions and be permitted by the manufacturer as a spare part. These spare parts may only be fitted by the manufacturer or an authorised specialist workshop. The authorised dealers and service centres are available for any spare parts requirement.

Here are some suggestions of important spare parts:

- Fuses
- V-belt
- Windscreen blades
- Bulbs
- Water pump (submerged pump)

When ordering spare parts please indicate the chassis number and the vehicle type to the dealer.

The vehicle described in this instruction manual is built and equipped to factory standards. Special equipment is offered depending on its purpose or use. When fitting special equipment check if such equipment has to be entered in the vehicle documents. Observe the max. permissible gross weight. The authorised dealer or service centre will be happy to advise you.

12.10 Vehicle identification plate

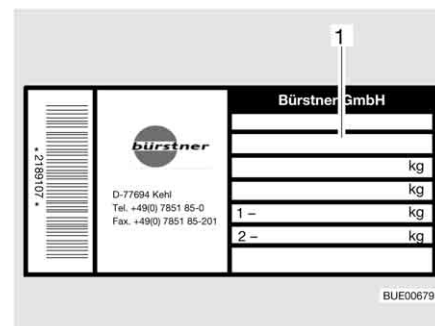

1 Chassis number

Fig. 249 Vehicle identification plate

The vehicle identification plate (Fig. 249) with the chassis number is located inside in the entrance area.

Do not remove the vehicle identification plate. The vehicle identification plate:

- Identifies the vehicle
- Helps with the procurement of spare parts
- Together with the vehicle documents identifies the vehicle owner



- ▷ Always include the **chassis number** with all inquiries for the customer service office.

12.11 Warning and information stickers

There are warning and information stickers on and inside the vehicle. Warning and information stickers are for the sake of safety and must not be removed.



- ▷ Replacement stickers can be obtained from an authorised dealer or a service centre.



Chapter overview

This chapter contains instructions regarding the tyres of the vehicle.

The instructions address the following topics:

- tyre selection
- handling of tyres
- changing wheels
- spare wheel support

At the end of the chapter there is a table you can use to find the correct tyre pressure for your vehicle.

13.1 General



- ▶ Check tyre pressure before a journey or every 2 weeks. Wrong tyre pressure causes excessive wear and can lead to damage or even to tyre burst. You can lose control of the vehicle.



- ▷ Only check the tyre pressure on cold tyres.
- ▷ Tubeless tyres have been installed on the vehicle. Never install tubes in these tyres.
- ▷ Read the instruction manual for the base vehicle.



- ▷ Depending on the base vehicle and model the vehicles are only equipped with tyre repair kit as standard.
- ▷ In the case of a puncture, pull over to the side of the road. Make vehicle safe with a hazard warning triangle. Switch on the warning lights.
- ▷ Tyres on vehicles with tandem axles may wear faster.
- ▷ Tyres must not be older than 6 years as the material will become brittle over time. The four-digit DOT number on the tyre flank indicates the date of manufacture. The first two digits designate the week, the last two digits the year of manufacture.

Example: $\textcircled{0114}$ Week 01, year of manufacture 2014.

- Observe:**
- Check the tyres regularly (every 2 weeks) for equal tread wear, tread depth and external damage.
 - Replace tyres at the latest, when the minimum depth of tread stipulated by law is reached.
 - Always use tyres of the same model, same brand and same style (summer and winter tyres).
 - Only use tyres approved for the wheel rim type fitted. The permitted rim and tyre sizes are quoted in the vehicle documents and the authorised dealer or service centre will always be glad to give you advice.
 - Run-in new tyres for approx. 100 km (60 miles) at low speed since only then do they reach full strength.

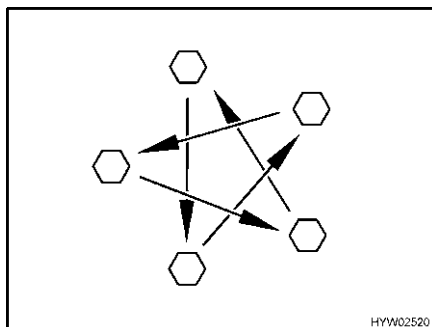

Fig. 250 Tighten the wheel nuts or wheel bolts cross-wise

- Check regularly that the wheel nuts or wheel bolts are firmly seated. Retighten the wheel nuts or wheel bolts of a changed wheel cross-wise (Fig. 250) after 50 km (30 miles). See section 13.5.2 for tightening torque.
- When using new or newly painted rims, re-tighten the wheel nuts or wheel bolts once again after approx. 1,000 to 5,000 km (600 miles to 3,000 miles).
- For lay-ups or long periods of inactivity, keep the tyres and tyre bearings free from pressure points:
Jack up the vehicle so that the wheels do not bear any load, or move the vehicle every 4 weeks in such a way that the position of the wheels is changed.

13.2 Tyre selection



- ▶ A wrong tyre can damage the tyres during the journey and even cause it to burst.



- ▷ If tyres that are not approved for the vehicle are used, then the type approval for the vehicle and subsequently the insurance coverage can lapse. The authorised dealer or service centre will be happy to advise you.

The tyre sizes approved for the vehicle are given in the vehicle documents or can be obtained from the authorised dealers or service centres. Each tyre must fit the vehicle on which it will be driven. This applies to the external dimensions (diameter, width), which are indicated with the standardised size designations. In addition, the tyres must meet the requirements of the vehicle with regard to weight and speed.

Weight refers to the maximum permissible axle load which can be distributed on two tyres. The maximum load-carrying capacity of a tyre is indicated by its load index (= LI, load index code).

The axle geometry of a vehicle, such as wheel camber and track, is also important for tyre selection. The maximum permissible speed for a tyre (with full load-carrying capacity) is indicated by the speed index (= SI). Together, load index and speed index form the operating code of a tyre. This is an official component of the complete, standardised dimensions description which appears on every tyre. The information on the tyres must correspond to the specifications which appear in the vehicle papers.

13.3 Tyre specifications

215/70 R 15C 109/107 Q
(example)

Description	Explanation
215	Tyre width in mm
70	Height-to-width proportion in percent
R	Tyre design (R = radial)
15	Rim diameter in inches
C	Commercial (transporter)
109	Load index code for single tyres
107	Load index code for twin tyres
Q	Speed index (Q = 160 km/h)

13.4 Handling of tyres

- Drive over kerbs at an obtuse angle. Otherwise the flanks of the tyres may get pinched. Driving over a kerb at a sharp angle can damage the tyre and result in it getting ruptured.
- Drive over high manhole covers at a slow speed. Otherwise the tyres may get pinched. Driving over a high manhole cover at high speed can damage the tyre and result in it getting ruptured.
- Check the shock absorbers regularly. Driving with poor shock absorbers significantly increases wear.
- If the tread wear is uneven, have the toe-in and the wheel camber checked. Driving with an incorrectly set toe-in or a one-sided wheel camber leads to a significant increase in wear.
- Avoid block brakings. Block braking gives the tyres "brake plates" of varying strength. This reduces driving comfort. It might even make the tyres unserviceable.
- Do not clean the tyres with a high-pressure cleaner. The tyres can suffer serious damage within just a few seconds and rupture as a result.
- Drive in such a way as to protect your tyres. Avoid braking sharply, revving up too strongly and long journeys on poor roads.

13.5 Changing wheels

13.5.1 General instructions



- ▶ The vehicle must be on level, firm ground, secure from slipping.
- ▶ Go into first gear. In the case of automatic transmission, change gear to "P" position.
- ▶ Before jacking up the vehicle firmly apply the handbrake.
- ▶ Prevent the vehicle from rolling away by blocking the opposite wheel with the wheel chocks.
- ▶ Under no circumstances jack the vehicle with the fitted supports.
- ▶ If a trailer is connected: Detach the trailer before lifting the vehicle.
- ▶ Position the vehicle jack underneath the axle, not under any circumstances on the bodywork.



- ▶ Never overload the vehicle jack. The maximum permissible load is specified on the vehicle jack's identification plate.
- ▶ Use the vehicle jack only for lifting the vehicle briefly while changing the tyre.
- ▶ No persons may be in the vehicle while it is raised.
- ▶ Do not start the motor while the vehicle is jacked up.
- ▶ Whilst the vehicle is in a jacked up position, persons must not lie down under it.



- ▷ Do not damage the thread of the thread bolt or wheel bolt when changing the wheel.
- ▷ Tighten the wheel nuts or wheel bolts cross-wise (Fig. 250).
- ▷ When changing wheels (e.g. alloy wheel rims or wheels with winter tyres), use the correct wheel bolts of the correct length and shape. Otherwise the wheels may not be securely fixed or the braking system may not work correctly.
- ▷ The use of wheel rims or tyres that are not approved for the vehicle can make it less than fully roadworthy; such wheel rims or tyres must be separately inspected and approved by an accredited test centre.
- ▷ Do not replace wheels cross-wise.



- ▷ Protect the vehicle according to the national regulations, e.g. with a hazard warning triangle.
- ▷ Before changing the wheel, check the wheel rim and tyre size, the max. tyre load and the speed index on the tyres. Only use the wheel rim and tyre sizes stated in the vehicle documents.
- ▷ Further information can be found in the instruction manual of the base vehicle.

13.5.2 Tightening torque

Depending on the wheel rim type and the wheel manufacturer, the wheels must be tightened with different tightening torques.

Steel wheel rims

Description	Tightening torque
15"	160 Nm
16"	180 Nm



Fig. 251 Steel wheel rim (standard)

Alloy wheel rims

Description	Tightening torque
15" Borbet HW65560	130 Nm
16" Borbet HW65660	130 Nm
15" Tomason TN3F-6515	180 Nm
16" Tomason TN3F-6516	180 Nm
15" Goldschmitt GSM1-1560	180 Nm
16" Goldschmitt GSM1-1665	180 Nm
15" Irmischer IC-Line	180 Nm
16" Irmischer IC-Line	180 Nm



Fig. 252 Borbet



Fig. 253 Tomason



Fig. 254 Goldschmitt



Fig. 255 Irmischer IC-Line

13.5.3 Changing a wheel



- ▶ The footplate of the vehicle jack must be levelly positioned on the ground.
- ▶ Do not tilt the vehicle jack.
- ▶ Never apply the handbrake when changing wheels on the rear axle of Model A 747-2. If the handbrake is applied, the vehicle jack could break.



- ▷ The wheel you have replaced should be repaired immediately.
- ▷ Take note of the general instructions in this chapter.

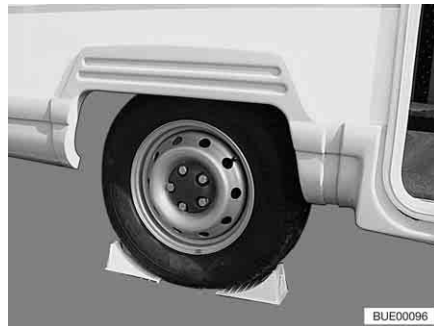

Fig. 256 Securing vehicle

- Park the vehicle on as even and stable a surface as possible.
- Switch off the engine and safeguard the area.
- Engage first gear or reverse gear.
- Apply the handbrake.
- Place wheel chocks or other appropriate objects beneath the opposite wheel of the vehicle to secure it (Fig. 256).
- Remove the spare wheel from the spare wheel support.
- If the ground is soft, place a stable support such as a wooden board beneath the vehicle jack.
- Apply the vehicle jack to the designated mounting points (refer to the instruction manual for the base vehicle).
- Turn the wheel bolts several times to loosen them, but do not remove them.
- Lift the vehicle until the wheel has been lifted 2 to 3 cm above the ground.
- Remove the wheel bolts and take off the wheel.
- Place the spare wheel on the wheel hub and adjust.
- Screw in the wheel bolts and slightly tighten them cross-wise.
- Crank down the vehicle jack and remove it.
- Using the wheelbrace, tighten the wheel bolts evenly (see section 13.5.2 for tightening torque).
- Have the tightening torque checked by an authorised specialist workshop.

13.6 Spare wheel support under the vehicle (special equipment)

Depending on the model, the spare wheel can be found under the vehicle or in the rear garage.

13.6.1 Spare wheel support under the vehicle (basket)



- ▶ Due to its weight and fitted position, the spare wheel can be raised or lowered by a very strong person only. Always get a second person to assist.

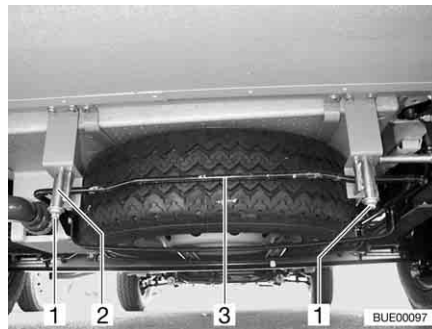

Fig. 257 Spare wheel support (basket)

Removing the spare wheel:

- Loosen the nuts (Fig. 257,1) on the right and left rear hooks (Fig. 257,2) of the spare wheel support.
- Unscrew the wheel nuts approx. 3 to 4 cm.
- Pull the bar (Fig. 257,3) slightly upwards. At the same time, pull down the hooks and unhook the bar.
- Take down the basket and remove the spare wheel.

13.6.2 Spare wheel support in the rear garage

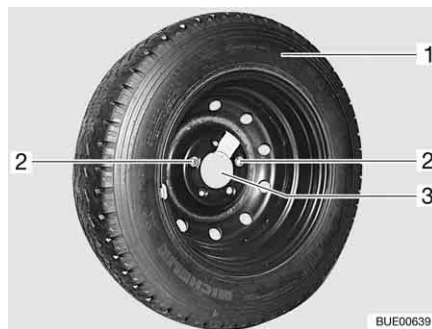

Fig. 258 Spare wheel support in the rear garage

Removing the spare wheel:

- Open external flap of the rear garage.
- Loosen and remove both fixing screws (Fig. 258,2) with the on-board tool set.
- Remove the spare wheel (Fig. 258,1) from the support (Fig. 258,3).

13.7 Tyre pressure



- ▶ Tyres overheat if the tyre pressure is too low. This can cause serious tyre damage.
- ▶ Check tyre pressure before a journey or every 2 weeks. Wrong tyre pressure causes excessive wear and can lead to damage or even to tyre burst. You can lose control of the vehicle.
- ▶ Use only valves that are approved for the specified tyre pressure.



- ▷ Only check the tyre pressure on cold tyres.

The payload and the durability of tyres is directly dependent on the tyre pressure. Air is a volatile medium. It is unavoidable that it will escape from tyres.

As a rule of thumb it can be assumed that a filled tyre loses pressure at a rate of 0.1 bar every two months. To prevent the tyres becoming damaged or burst, check the tyre pressure regularly.

The contact surface of the tyre changes, depending on the tyre pressure.

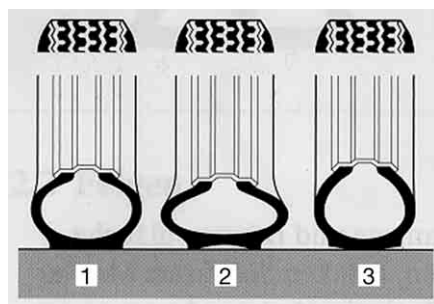

- 1 Correct tyre pressure
- 2 Tyre pressure too low
- 3 Tyre pressure too high

BUE00098

Fig. 259 Contact surface of the tyre



- ▷ The information on pressure levels is valid for cold tyres and loaded vehicles.
- ▷ Pressure in hot tyres must be 0.3 bar higher than in cold tyres. Recheck the pressure when the tyres are cold.
- ▷ Tyre pressures in bar.
- ▷ The tyre pressure tolerance is +/- 0.05 bar.

Types	Tyre size	Front air pressure in bar	Rear air pressure in bar
All types	215/70 R 15 C (109/107) Q	4.1	4.5
All types with motorhome tyres	215/70 R 15 CP (109/107) Q	5.0	5.5
All types with winter tyres (M+S)	215/70 R 15 C (109/107) Q	4.3	4.75
All types	225/75 R 16 C (116/114) Q	4.5	5.0
All types with motorhome tyres	225/75 R 16 CP (116/114) Q	5.5	5.5
All types with winter tyres (M+S)	225/75 R 16 C (116/114) Q	5.2	5.2
All types	225/75 R 16 C (116/114) Q (tandem axle)	4.5	3.8
All types with motorhome tyres	225/75 R 16 CP (116/114) Q (tandem axle)	5.5	3.8
All types with winter tyres (M+S)	225/75 R 16 C (116/114) Q (tandem axle)	5.2	3.8

The vehicles are constantly brought up to the newest technical standards. It is possible that new tyre sizes are not yet included in this table. If this is the case, any authorised dealer or service centre will be happy to provide the newest values.

Chapter overview

This chapter contains instructions about possible faults in your vehicle. The faults are listed with their possible causes and corresponding remedies. The instructions address the following topics:

- braking system
- pneumatic spring
- electrical system
- fuel cell
- gas system
- heater
- boiler
- air conditioning unit
- gas cooker
- gas oven
- microwave oven
- refrigerator
- water supply
- body

The specified faults can be remedied with relative ease and without a great deal of specialised knowledge. In the event that the remedies detailed in this instruction manual should not be successful, an authorised specialist workshop must find and eliminate the cause of the fault.

14.1 Braking system



- ▶ Have defects on the braking system immediately remedied by an authorised specialist workshop.

14.2 Pneumatic spring



- ▶ Have defects on the air suspension immediately remedied by an authorised specialist workshop.

Fault	Cause	Remedy
Vehicle is at an angle	Alternation of load after switching off the pneumatic spring	Switch pneumatic spring on, lower it and reset the driving level
Remote control does not react	Ignition switched off	Switch on ignition
	Fuse 7.5 A is defective	Change fuse 7.5 A
	Operating voltage too low	Charge vehicle battery
Compressor does not run	Ignition switched off	Switch on ignition
	Fuse 40 A is defective	Replace fuse
	Operating voltage too low	Charge the starter battery

Fault	Cause	Remedy
Compressor does not switch off	Compressor relay is defective	Remove fuse 40 A
	Deflation	Contact a specialist workshop
Pneumatic spring does not lower	Driving speed is too high	Observe speed limit
	Fuse is defective	Change fuse 7.5 A
Pneumatic spring does not lift	Vehicle too heavily loaded	Reduce load



- ▷ If the system identifies a fault, the control light blinks. A fault code can then be called up using the stop button.

See the manufacturer's operating manual for the meaning of individual fault codes.

14.3 Electrical system



- ▷ When the living area battery is changed, only use batteries of the same type and the same capacity.



- ▷ See chapter 8 for changing the fuses.

Fault	Cause	Remedy
Road light system does no longer work correctly	Bulb is defective	Replace bulb. Note volts and watts specifications
Interior lighting does no longer work correctly	Bulb is defective	Replace bulb. Note volts and watts specifications
	Plug connector or cable defective	Contact customer service
	Fuse on the transformer/rectifier is defective	Replace fuse on the transformer/rectifier
One or several light circuits cannot be switched on	One of the voltage inputs is not supplied	Check supply from transformer/from the 12 V supply: <ul style="list-style-type: none"> ● If a fuse is defective: Change the fuse ● If the supply device is switched off: Switch the supply device on ● If the supply device is defective: Contact customer service
		Defective cabling
	Defective light control	Contact customer service
No light circuit can be switched on	Battery is discharged	Charge the battery
	Defective light control	Contact customer service

Fault	Cause	Remedy
Light scenes cannot be saved	Defective light control	Contact customer service
The electrically operated entrance step cannot be moved in or out	Fuse on the transformer/rectifier is defective	Replace fuse on the transformer/rectifier
"-40" or "60" flashes when the temperature display is selected	External temperature sensor or connecting cable to the external temperature sensor is defective	Contact customer service
230 V indicator lamp does not light up, although 230 V mains power supply is connected	The mains connection is de-energised	Check mains connection (e.g. campsite)
No 230 V power supply despite connection	230 V automatic circuit breaker has triggered	Switch on the 230 V automatic circuit breaker
	The mains connection is de-energised	Check the mains connection
Starter or living area battery is not charged when operated in 230 V mode	Jumbo flat fuse (50 A) on the starter or living area battery is defective	Replace jumbo flat fuse (50 A) on the starter or living area battery
	Charger module in the transformer/rectifier is defective	Contact customer service
Living area battery is not charged during vehicle operation	Fuse on terminal D+ of the alternator is defective	Replace fuse
	Disconnecter relay in the transformer/rectifier is defective	Contact customer service
Living area battery overloaded ("hot")	Battery selection switch set wrongly	Move position of battery selection switch
	Defective load sensor or relay	Contact customer service
12 V power supply does not work	12 V power supply switched off	Switch 12 V power supply on
	Battery cut-off switch on the transformer/rectifier switched off or battery separation activated	Switch on battery cut-off switch or deactivate battery separation via the panel
	Living area battery is discharged	Charge the living area battery
	Jumbo flat fuse (50 A) on the living area battery is defective	Replace jumbo flat fuse (50 A) on the living area battery
	Disconnecter relay in the transformer/rectifier is defective	Contact customer service

Fault	Cause	Remedy
12 V power supply does not work in 230 V operation	12 V power supply switched off	Switch 12 V power supply on
	Battery cut-off switch on the transformer/rectifier switched off or battery separation activated	Switch on battery cut-off switch or deactivate battery separation via the panel
	Charger module in the transformer/rectifier is defective	Contact customer service
	230 V automatic circuit breaker has triggered	Contact customer service
	Jumbo flat fuse (50 A) on the living area battery is defective	Replace jumbo flat fuse (50 A) on the living area battery
Starter battery is discharged in 12 V operation	Disconnecter relay in the transformer/rectifier is defective	Contact customer service
	Battery cut-off switch on the transformer/rectifier switched off or battery separation activated	Switch on battery cut-off switch or deactivate battery separation via the panel
No voltage is supplied by the living area battery	Living area battery is discharged	Charge living area battery immediately  ▷ Total discharge damages the battery. Before the vehicle is laid up for a long period, fully charge the living area battery and then activate the battery separation/lay-up Discharging is caused by inactive appliances e.g. frost protection valve of the hot-water heater (see chapter 8)
The 12 V indicator lamp does not light up or there is no display on the panel	12 V power supply switched off	Switch 12 V power supply on
	Battery cut-off switch on the transformer/rectifier switched off or battery separation activated	Switch on battery cut-off switch or deactivate battery separation via the panel
	Starter or living area battery is not charged	Charge the starter or living area battery
	Disconnecter relay in the transformer/rectifier is defective	Contact customer service
	Flat fuse (2 A) in the living area battery is defective	Replace flat fuse (2 A) in the living area battery

Fault	Cause	Remedy
Extractor hood does not work	230 V automatic circuit breaker is switched off	Switch on the 230 V automatic circuit breaker
	Fuse (15 A) at the transformer/rectifier is defective	Replace fuse (15 A)
	Extractor hood defective	Contact customer service

14.4 Fuel cell



- ▷ Do not open the fuel cell. The fuel cell contains no parts that could be repaired by itself.
- ▷ All faults are not displayed. If the faults cannot be rectified using the following table or the instruction manual for the fuel cell, please contact the customer service.

Fault (display)	Cause	Remedy
Fuel cell cannot be switched on	No battery connected, battery connected incorrectly or totally discharged	Inspect the connection
	Fuse is defective	Replace fuse; if it happens again, contact the customer service
Failure: Environment too warm	Ambient temperature too high (40 °C)	Fuel cell restarts when the ambient temperature is between 0 °C and 40 °C

14.5 Gas system



- ▶ In case of a defect of the gas system (gas odour, high gas consumption) there is danger of explosion! Close regulator tap on the gas bottle immediately. Open doors and windows and ventilate well.
- ▶ If the gas system is defective: Do not smoke; do not ignite any open flames, and do not operate electric switches (light switches etc.).
- ▶ Have the defective gas system repaired by an authorised specialist workshop.

Fault	Cause	Remedy
No gas	Gas bottle is empty	Change gas bottle
	Gas isolator tap closed	Open the gas isolator tap
	Regulator tap on the gas bottle is closed	Open regulator tap on the gas bottle
	External temperature is too low (-42 °C for propane gas, 0 °C for butane gas)	Wait for higher external temperatures
	Built-in appliance is defective	Contact customer service

14.6 Heater/boiler

In the event of a defect contact the nearest customer service workshop of the relevant appliance manufacturer. The list of addresses is enclosed with the accompanying appliance documentation. Only authorised qualified personnel may repair the appliance.

14.6.1 Truma heater/boiler with analogue operating unit

Fault	Cause	Remedy
Heater does not ignite	Temperature sensor on operating unit or remote sensor defective	Pull out plug on operating unit. The heater then works without thermostat. Contact the customer service as soon as possible
Boiler empties, safety/drainage valve has opened	Internal temperature below 8 °C	Heat inside
Safety/drainage valve cannot be closed	Temperature at safety/drainage valve below 8 °C	Heat inside
Fan wheel runs noisily or not steadily	Fan wheel is soiled	Contact Truma service department
Fault is displayed	See flash sequence table	See flash sequence table

Blink sequence In the event of an error, the LEDs flash as follows:

- On/off 0.5 seconds
- Pause 5 seconds

Fault	Cause	Remedy
None of the LEDs comes on, device is switched on, operating voltage is connected	Automatic restart is blocked, e.g. following an interruption of the power supply	Reset the device (switch off, wait 5 seconds, switch on again)
After switching on (winter and summer operation) none of the LEDs comes on	No operating voltage	Check 12 V battery voltage, load battery if necessary
	Appliance fuse or vehicle fuse defective	Check all electrical plug connectors
After switching on, the green LED comes on but the heater does not work	The temperature set on the control unit is below room temperature	Check appliance fuse or vehicle fuse and replace if necessary
Green LED comes on, yellow LED flashes 1 x (heater still in operation)	Risk of undervoltage; battery voltage too low < 10.4 V	Set a higher temperature on the control unit
Green LED comes on, yellow LED flashes 2 x (no further operation)	Undervoltage; battery voltage too low < 10.0 V	Charge the battery
	Overvoltage > 16.4 V	Charge battery or replace
		Check battery voltage and voltage sources (e.g. charging unit)

Fault	Cause	Remedy
Green LED comes on, yellow LED flashes 4 x After extended operation, heater registers a fault	Summer operation with empty water container	Switch off the device and allow it to cool, fill boiler with water
	Warm air louvres blocked	Check outlet openings
	Air circulation suction system blocked	Remove blocking of air circulation suction system
Green LED comes on, yellow LED flashes 5 x	Room temperature sensor or cable defective	Contact customer service
Green LED comes on, yellow LED flashes 7 x	Control unit or cable defective	Contact customer service
Green LED comes on, yellow LED flashes 8 x	Short circuit in heating element for frost control	Remove plug of heating element on the electronic control unit, replace the heating element
Green LED comes on, yellow LED flashes 9 x approximately 30 seconds after the heater is switched on	Regulator tap or gas isolator tap is closed	Open regulator tap or gas isolator tap
	Gas bottle is empty	Change gas bottle
After extended operation, heater registers a fault	Gas pressure regulator iced up	Use regulator heater (defroster)
	Level of butane in the gas bottle too high	Use propane gas (especially for temperatures below 10 °C, butane is not suitable for heating)
Red LED flashes 1 to 8 times (device on)	Fault in the heater	Contact customer service
Green LED flashes 5 x after the heater has been switched off	Overrun is active to reduce temperature of appliance	No error; overrun switches off after approximately 5 minutes
After the appliance is switched on, the green and red LEDs come on	Electronics defective	Contact customer service

14.6.2 Truma heater/boiler with CP plus digital operating unit

Fault	Cause	Remedy
Heater does not ignite	Temperature sensor on operating unit or remote sensor defective	Pull out plug on operating unit. The heater then works without thermostat. Contact the customer service as soon as possible
No display on the operating unit	Fuse on the transformer/rectifier is defective	Replace fuse on the transformer/rectifier
	Fuse in the electronic control unit has been triggered	Contact customer service
	Living area battery defective	Charge or replace the living area battery (or have it charged or replaced)

Fault	Cause	Remedy
Fault with error code is displayed	See table "Fault search instruction"	See table "Fault search instruction"
Boiler empties, safety/drainage valve has opened	Internal temperature below 8 °C	Heat inside
Safety/drainage valve cannot be closed	Temperature at safety/drainage valve below 8 °C	Heat inside
Fan wheel runs noisily or not steadily	Fan wheel is soiled	Contact Truma service department

Fault search instruction

Error code	Cause	Rectification
# 17	Summer operation with empty water container	Switch off the device and allow it to cool down. Fill the boiler with water
	Warm air louvres blocked	Check outlet openings
	Air circulation suction system blocked	Remove blocking of air circulation suction system
# 18	Gas pressure regulator iced up	Use regulator heater (defroster if available)
	Proportion of butane gas in gas bottle too high	Use propane gas (butane gas is unsuitable for heating especially for temperatures under 10 °C)
# 21	Room temperature sensor or cable defective	Contact customer service
# 24	Risk of undervoltage Battery voltage too low < 10.4 V	Charge the battery
# 29	Short circuit in heating element for frost control	Remove plug of heating element on electronic control unit. Replace heating element
# 41	Electronics blocked	Contact customer service
# 42	Safety switch has triggered	(Not used here)
# 43	Overvoltage > 16.4 V	Check battery voltage and voltage sources (e.g. charging unit)
# 44	Undervoltage Battery voltage too low < 10.0 V	Charge battery. Replace outdated battery if required
# 45	No 230 V power supply	Check external mains connection
	230 V automatic circuit breaker has triggered	Switch on the 230 V automatic circuit breaker
	Overheating protection has triggered	Reset overheating protection. Allow heater to cool, remove connection cover and press reset button
#112, #202, #121, #211	Lack of gas	Open regulator tap and gas isolator tap
		Connect a full gas bottle

Error code	Cause	Rectification
#122, #212	Combustion air inlet or exhaust gas outlet closed	Check openings for dirt (slush, ice, leaves etc.) and clean if necessary
#255	No connection between heater and operating unit	Contact customer service
	Cable defective	Contact customer service

14.6.3 Alde heater/boiler



▷ If a fault occurs in the system, the cause is shown on the display.

Fault	Cause	Remedy
Heater does not ignite with gas operation	Lack of gas	Open regulator tap and gas isolator tap
		Connect a full gas bottle
Heater does not ignite	Battery voltage too low	Charge battery. If the battery voltage rises above 11 V, the heater is switched on automatically
Heater does not ignite at 230 V electrical operation	No 230 V power supply	Switch on the 230 V automatic circuit breaker
		Connect the 230 V power supply
Heater switches off	Overheating	Allow the heater to cool. To reset the display, interrupt the 12 V power supply to the heater and switch it back on again
Heater running, but no heat at the convectors	Circulating pump does not work	Switch on room thermostat
		Contact customer service
Heater and circulating pump running, but no heat at the convectors	Air in the heating system	Bleed hot-water heater

14.7 Air conditioning unit

14.7.1 Dometic

Fault	Cause	Remedy
Air conditioning unit does not start up	No 230 V power supply	Connect the vehicle to the local power supply
	230 V automatic circuit breaker has triggered	Switch on the 230 V automatic circuit breaker
	Remote control batteries empty	Change remote control batteries
Air conditioning unit does not cool	Temperature below 16 °C	–
	Temperature has been set incorrectly	Adjust the temperature
	Thermostat defective	Contact customer service
Air conditioning unit does not warm up	Temperature above 30 °C	–
	Temperature has been set incorrectly	Adjust the temperature
	Thermostat defective	Contact customer service
Water is entering the vehicle	Drainage holes for condensation are clogged	Clean air conditioning unit
	Seal is defective	Contact customer service
No more air circulation	Air filter clogged	Clean air filter
	Fan wheel defective	Contact customer service

14.7.2 Telair

Fault	Cause	Remedy
Air conditioning unit does not start up	No 230 V power supply	Connect 230 V power supply
	230 V automatic circuit breaker has triggered	Switch on the 230 V automatic circuit breaker
	Remote control batteries empty	Change batteries (2 x AAA)
Air conditioning unit does not cool	Room temperature is lower than the preset temperature	Reset temperature
Air conditioning unit does not heat	Room temperature is higher than the preset temperature	Reset temperature
Insufficient ventilation rating	Ventilation flaps closed	Open at least one ventilation flap
	Filter dirty	Clean the filter
Water is entering the vehicle	Drainage holes for condensation are clogged	Clean air conditioning unit

14.8 Cooker

14.8.1 Gas cooker/gas oven

Fault	Cause	Remedy
Ignition fuse does not operate (flame does not burn after the control knobs are released)	Heat-up time is too short	Keep control knob pressed for approx. 15 to 20 seconds after ignition
	Ignition fuse is defective	Contact customer service
Flame extinguishes when being reduced to its minimum setting	Thermocouple sensor is incorrectly set	Correctly reset thermocouple sensor (do not bend). The sensor tip should protrude by 5 mm beyond the burner. The sensor neck should not be more than 3 mm away from the burner ring; if necessary, contact customer service

14.8.2 Microwave oven



- ▶ Only qualified personnel may repair the microwave oven. Improper repairs can cause major risks to the user.

Fault	Cause	Remedy
Microwave oven does not cut in	Fuse is defective	Replace fuse
	Door of the microwave oven is not properly closed	Remove foreign bodies stuck in the door of the microwave oven and close door properly





14.9 Refrigerator

In the event of a defect contact the nearest customer service workshop of the relevant appliance manufacturer. The list of addresses is enclosed with the accompanying appliance documentation. Only authorised qualified personnel may repair the appliance.



- ▷ In the event of a fault, the "Fault" indicator lamp will always light up as well and an acoustic signal will sound for about 20 seconds.

Fault	Cause	Remedy
LED "⚡" flashes	No 230 V power supply	Connect the 230 V power supply
	230 V automatic circuit breaker has triggered	Switch on the 230 V automatic circuit breaker
	230 V operating voltage too low	Have the 230 V power supply checked by an authorised specialist workshop

Fault	Cause	Remedy
LED "  " flashes	Fuse on the transformer/rectifier is defective	Replace fuse on the transformer/rectifier
	Disconnecter relay in the transformer/rectifier is defective	Contact customer service
	12 V operating voltage too low	Have the 12 V power supply checked by an authorised specialist workshop
	No D+ signal	Contact customer service
LED "  " flashes ¹⁾	Lack of gas	Open regulator tap and gas isolator tap
		Connect a full gas bottle
LEDs for display of the temperature range flash	Cobwebs or burnt residue in the burning chamber	Remove the ventilation grill on the outside of the vehicle and clean the burning chamber
		Temperature sensor defective
LED "  " and LEDs for display of the temperature range flash	230 V heater element defective	Contact customer service
LED "  " and LEDs for display of the temperature range flash	12 V heater element defective	Contact customer service
LED "  " and LEDs for display of the temperature range flash	Faulty burner or power unit	Contact customer service
Refrigerator does not refrigerate sufficiently	Insufficient ventilation of unit	Check if ventilation grills are covered; remove covers if necessary
		Remove ventilation grills and clean the space behind them (of leaves etc.)
	Ambient temperatures are too high	Remove the ventilation grills periodically

¹⁾ After fixing the issue, press the illuminated button for "Fault"/"Reset".

14.10 Water supply

Fault	Cause	Remedy
Leakage water inside the vehicle	A leak has occurred	Identify leak, re-connect water pipes
No water	Water tank is empty	Replenish drinking water
	Drain cock not closed	Close drain cock
	12 V power supply switched off	Switch 12 V power supply on
	Fuse of the water pump is defective	Replace fuse on the transformer/rectifier
	Water pump defective	Exchange water pump (have it exchanged)
	Water pipe snapped off	Straighten water pipe or replace
	Transformer/rectifier defective	Contact customer service
	Water pump switched off on panel	Switch water pump on
Toilet has no flush water	Water tank is empty	Replenish drinking water
	Fuse for toilet is defective	Replace fuse
Display for water and waste water indicates a wrong value	Measuring probe in the waste water or water tank is soiled	Clean water/waste water tank
	Measuring probe is defective	Replace measuring probe
Waste water tank cannot be emptied	Drain cock is clogged	Open the cleaning cap on the waste water tank and drain the waste water. Rinse the waste water tank well
Drain on the single lever mixer tap is clogged	Perlator calcified	Unclip the perlator, de-calcify in vinegar water (only for products made from metal)
Water jets on the shower nozzle clogged	Water jets calcified	De-calcify shower nozzle in vinegar water (only for products made from metal) or rub off soft nozzle burling
Water drains from the shower tray slowly or does not drain at all	The vehicle is not in a horizontal position	Position the vehicle horizontally
Milkieness of the water	Tank filled with dirty water	Clean water tank mechanically and chemically; then disinfect and rinse copiously with drinking water
	Residues in the water tank or water system	Clean water system mechanically and chemically; then disinfect and rinse copiously with drinking water

Fault	Cause	Remedy
Any change in the taste or odour of the water	Tank filled with dirty water	Clean water system mechanically and chemically; then disinfect and rinse copiously with drinking water
	Fuel filled into the water tank by mistake	Clean water system mechanically and chemically; then disinfect and rinse copiously with drinking water. If not successful: Contact a specialist workshop
	Microbiological deposits in the water system	Clean water system mechanically and chemically; then disinfect and rinse copiously with drinking water
Deposits in the water tank and/or water-carrying components	Water excessively long in the water tank and in water-carrying components	Clean water system mechanically and chemically; then disinfect and rinse copiously with drinking water

14.11 Body

Fault	Cause	Remedy
Flap hinges/door hinges are difficult to operate	Flap/door hinges are not sufficiently lubricated	Lubricate flap hinges/door hinges with acid-free and resin-free grease
Hinges/joints in the bathroom unit/toilet compartment are difficult to operate/make a grating noise	Hinges/joints are not sufficiently lubricated	Lubricate hinges/joints with solvent-free and acid-free grease  ▷ Spray cans often contain solvents
Storage compartment hinges are difficult to operate/make a grating noise	Storage compartment hinges are not sufficiently lubricated	Lubricate storage compartment hinges with acid-free and resin-free grease
Wind-up skylight is difficult to operate	Threaded spindle not lubricated	Lubricate threaded spindle
	Threaded spindle defective	Have threaded spindle replaced



- ▷ The authorised dealers and service centres are available for any spare parts requirement.

15.1 Weight details for special equipment



- ▶ The use of accessories, parts and fittings not supplied by us may cause damage to the vehicle and jeopardize road safety. Even if an expert's report, a general type approval or a design certification exists, there is no guarantee for the proper quality of the product.
- ▶ Every alteration of the original condition of the vehicle can alter road behaviour and jeopardize road safety.
- ▶ No liability can be assumed for damage caused by products which have not been released by us. This also applies to impermissible alterations to the vehicle.

Weight details for factory-provided special equipment are listed in the table below. If these objects are either carried in or on the vehicle and are not part of the standard equipment, they must be taken into consideration when calculating the payload.

All weight details are approximate.

Observe the max. permissible gross weight.

Item designation	Surplus weight (kg)
Waste water pipes insulated and heated	2
Heatable waste water tank	1
Waste water tank and drainage isolated and heated	1
Airbag (front passenger)	3
Alcove window, left	3
Caravan coupling	40
Caravan coupling, detachable	30
Dashboard upgrade	2
Single-section conversion door with window and insect screen	30
External shower	1
External mirrors, electrically adjustable and heated	2
External socket	1
Automatic transmission	17
Car radio and CD	1
Fuel cell	7
Skylight Heki 3	15
Roof rail	5
Scatter cushions (4 pcs.)	2
Three-point seat belts in opposite direction to direction of travel (2 x)	30
Extractor hood	1
Electrical stability program (ESP)	3
Spare wheel with 15" support (rear garage)	20
Spare wheel with 16" support (rear garage)	21
Spare wheel 16" with support	31

Item designation	Surplus weight (kg)
External gas connection	1
Bike rack for 2 bicycles	10
Bike rack for 2 bicycles, lowerable	18
Bike rack for 3 bicycles	11
Bike rack for 3 bicycles, lowerable	20
Bike racks for e-bike	25
Roman shade, driver's cabin	4
Floor warming unit	4
Garage door, left	3
Gas oven	17
Gas bottle (11 kg) made of aluminium	12
Gas switching facility, automatic	2
Gas alarm system	5
Weight increase to 3850 kg for Fiat chassis	15
Holder for flat screen	3
Rear ladder	10
Truma Combi 6 EH heater	3
Insect screen, door (full height)	4
Air conditioning unit (Dometic)	30
Driver's cabin air conditioning unit	18
Air conditioning unit (Telair)	34
Fuel tank 120 l	50
Alloy wheel rims	-15
Alloy wheel rims (tandem axle)	-20
Alternator 180 Ah	2
Air Premium II pneumatic spring	79
Air Premium X4 pneumatic spring	113
Awning 350 cm	33
Awning 400 cm	38
Awning 600 cm	61
Microwave oven	14
Minisafe	12
Motorcycle rack	38
Motorcycle rack in the rear garage	12
Pioneer multimedia system	5
Zenec navigation system	4
Fog light	4
Pilot seats, covering as in living area	2
Radio preparation	4

Item designation	Surplus weight (kg)
Reversing camera	4
Satellite unit (Alden) + LCD television	14–25
Satellite unit (Oyster)	4
Solar installation 1 x 100 W	10
Solar installation 1 x 140 W	15
Solar installation 2 x 100 W	20
Fitted sheet for overcab bed	1
Independent vehicle heater	3
Storage system for garage wall	8
Steadies, electrically operated	20
Rear steadies	5
Bedspread	2
Telescopic ladder	10
Tempomat	3
Carpet in driver's cabin	2
Carpet in living area and driver's cabin	3
Air recirculation in alcoves	2
Water tank, additional 70 l	10
Winter insulation mat, outside	3
Auxiliary battery	27
Auxiliary heat exchanger (heater) for body	3
Two cross beams and slip protection for roof racks	3

Engine variants

The vehicle mass in a ready-to-drive state relates to the base vehicle. If a more powerful engine is fitted, the mass increases in a ready-to-drive state.

Engine variant	Surplus weight (kg)
2.3 Mjet	15
3.0 Mjet	50
2.3 Mjet Maxi	55
3.0 Mjet Maxi	90

Equipment packages

The equipment packages depend on the model. To calculate the additional weight, add the additional weights of the individual special equipment per package.

16.1 View of ground plans

Explanations

- (1) 230 V fuse
- (2) Transformer/rectifier with 12 V fuses
- (3) Living area battery with main fuse
- (4) Water pump mounted in the tank area
- (5) Drain cock, waste water tank
- (6) Safety/drainage valve
- (7) Boiler/heater
- (8) Water drain cock – yellow
- (9) Water tank
- (10) Additional heater (partially special equipment)
- (11) Alde hot-water heater
- (12) Compensator reservoir for Alde hot-water heater
- (13) Alde auxiliary heat exchanger
- (14) Water drain cock – white
- * Access via service flap
- ** Beneath the vehicle
- *** Access via kitchen floor cupboard

Specifications without guarantee

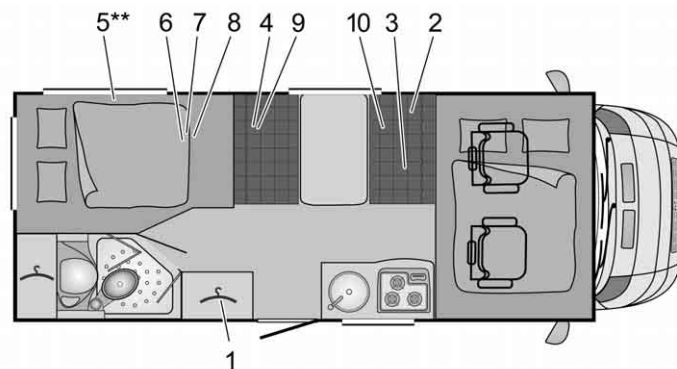

BUE01420

Fig. 260 Ground plan A 650

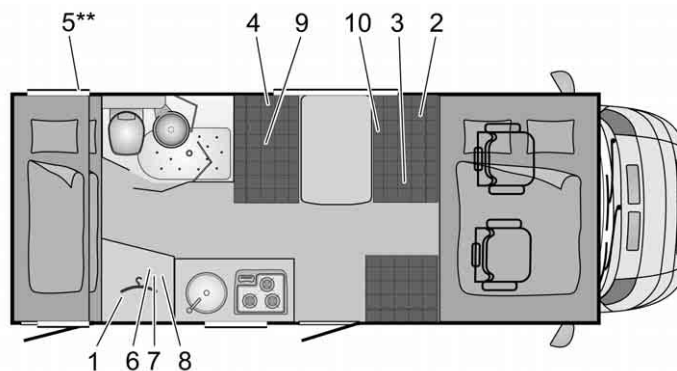

BUE01421

Fig. 261 Ground plan A 660

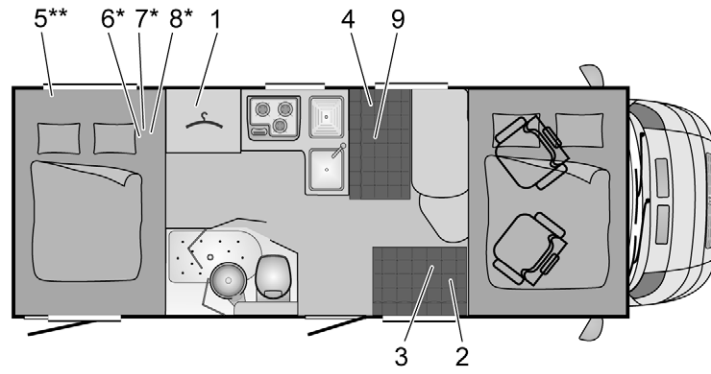

BUE01423

Fig. 262 Ground plan A 670 G

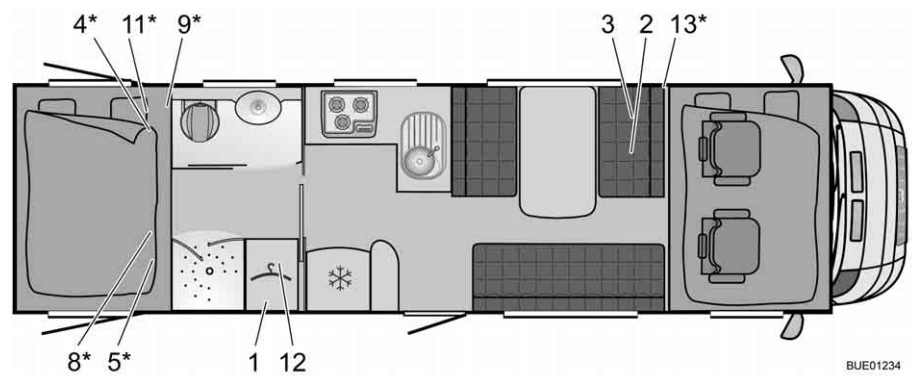

BUE01234

Fig. 263 Ground plan A 747-2 G

16.2 Table of linear measures

Type	Body width, exterior	Total length without ladder	Wheelbase	Overall height without antenna
A 650	2300	6480	3800	3150
A 660	2300	6600	3800	3150
A 670 G	2300	6780	4035	3150
A 747-2 G	2300	8860	4656/800	3250

16.3 Power supply

Mains connection	Protection class I	230 V ($\pm 10\%$), 47 - 63 Hz
Mains power rating		400 VA
Appropriate batteries	6-cell lead acid and lead acid gel batteries from 55 Ah	
Charging characteristics	IUoU	
Final charge voltage		14.3 V
Charging current	18 A throughout entire supply voltage range, electronically restricted	18 A
Trickle charge voltage	Automatic switching	13.8 V
Repeated charging cycle (switchover to "Main charging")	At < approx. 13.8 V battery voltage (with approx. 5 seconds delay)	
Reflux (without mains and with connected battery)	After approx. 3 minutes "Mains Off"	< 0.3 mA
Guard circuits	Short-circuit protection provided by built-in car fuse (FKS)	
	Safety fuse, 3.15 AT at power input	
	Overtemperature protection	
Charging current distribution at mains connection	Starter battery float charge with max. 2 A or 6 A	max. 2 A (EBL 99) or max. 6 A (EBL 220)
	Living area battery charge with max. 18 A	max. 18 A
Charging current distribution during the journey	Simultaneous charging of starter and living area batteries by means of the alternator	50 A
	Parallel battery switching via disconnecter relay	
	Maximum permitted alternator charging current to the living area battery: 50 A (see block diagram)	
Battery monitor	Disconnection	10.5 V \pm 0.1 V
Battery monitor	Minimum voltage for connection	11.0 V \pm 0.1 V

Chapter overview

This chapter contains helpful tips for the journey.

The instructions address the following topics:

- road assistance in European countries
- traffic rules in European countries
- gas supply in European countries
- toll regulations in European countries
- safe ways to spend the night during travel
- camping in winter

At the end of the chapter there is a checklist containing the most important equipment for the journey.

17.1 Traffic rules in foreign countries



- ▷ The vehicle driver is required to inform himself as to the traffic rules of the countries in which he plans to travel before beginning the trip. Contact your automobile club or embassy for further information.
- ▷ In some European countries, warning vests must be worn when exiting the vehicle outside of towns in the case of vehicle failures or accidents.
- ▷ Depending on the country, different rules and regulations apply (e.g. different warning signs for rear carriers, obligation to carry breathalyzer kits, spare bulbs, high-visibility vests, size of reserve canister). The driver of the vehicle must familiarise him or herself with these rules before every journey.
- ▷ Up-to-date information can generally be found on the web pages of the national automobile associations.

Information about traffic regulations is especially important as state law applies in case of damage. For your own safety, always observe the following rules when travelling abroad:

- Carry your insurance certificate with you.
- Always register accidents with the police.
- Never sign documents that you have not read and understood completely.

17.2 Help on Europe's roads

Country	+ Emergency services ★ Police	☎ Breakdown service
Belgium	+ 112 ★ 112	☎ TCB Brussels (02) 2 33 22 11 RACB Brussels (02) 2 87 09 11
Bosnia-Herzegovina	+ 124 ★ 122	☎ BI HAMK 33 21 27 72
Bulgaria	+ 112 ★ 112	☎ UAB (02) 9 35 79 35 UAB (02) 9 11 46/146 ¹⁾
Denmark	+ 112 free of charge ★ 112 free of charge	☎ FDM 45 27 07 07

Country	+ Emergen- cy services ★ Police	☎ Breakdown service
Germany	+ 112 ★ 110	☎ ADAC Munich (01 80) 2 22 22 22 ADAC 22 22 22 ¹⁾
Estonia	+ 112 ★ 112	☎ EAK 69 79 10 0 EESTI (0) 6 97 91 88/18 88 ¹⁾
Finland	+ 112 ★ 112	☎ ATCF Helsinki (09) 77 47 64 00
France	+ 15/112 ★ 17	☎ AIT-Assistance (08 00) 08 92 22
Greece	+ 112 ★ 112	☎ ELPA (021) 06 06 88 00
Great Britain	+ 112 ★ 112	☎ AA (0 87 05) 44 88 66
Ireland	+ 112 ★ 112	☎ AA Dublin (0) 16 17 99 99
Iceland	+ 112 ★ 112	☎ F.I.B 414 99 99
Italy	+ 112 ★ 112	☎ TC1 (0 02) 8 52 61 (0 06) 4 99 81
Croatia	+ 112 ★ 112	☎ HAK (01) 6 61 19 99
Latvia	+ 112 ★ 112	☎ LAMB (0 67) 56 62 22
Lithuania	+ 112 ★ 112	☎ LAS (0 52) 10 44 33
Luxembourg	+ 112 ★ 112	☎ ACL (04) 50 04 51
Macedonia	+ 194 ★ 192	☎ AMSM (02) 3 18 11 81
Montenegro	+ 112 ★ 112	☎ AMS CG (0 20) 23 49 99
Netherlands	+ 112 ★ 112	☎ ANWB (0 88) 2 69 71 47 KNAC (0 70) 3 83 16 12
Norway	+ 113 ★ 112	☎ NAF (092) 60 85 05 KNA (0 21) 60 49 00
Austria	+ 112 ★ 112	☎ ÖAMTC (01) 71 19 90
Poland	+ 112 ★ 112	☎ PZM (0 22) 8 49 93 61
Portugal	+ 112 ★ 112	☎ ACP (02 13) 18 01 00

Country	+ Emergency services ★ Police	☎ Breakdown service
Romania	+ 112 ★ 112	☎ ACR (0 21) 3 15 55 10
Russia	+ 03 ★ 02	☎ RAS (04 95) 6 29 07 07 ACAR (04 95) 9 25 50 00
Sweden	+ 112 ★ 112	☎ M Stockholm (08) 6 90 38 00
Switzerland	+ 144 ★ 112	☎ TCS (0 22) 4 17 27 27 ACS (0 31) 3 28 31 11
Serbia	+ 112 ★ 112	☎ AMSS (0 11) 3 33 11 00
Slovakia	+ 112 ★ 112	☎ SATC (02) 68 24 92 11
Slovenia	+ 112 ★ 112	☎ AMZS (01) 5 30 51 00
Spain	+ 112 ★ 112	☎ RACE 9 02 40 45 45
Czech Republic	+ 112 ★ 112	☎ UAMK (02 61) 10 41 11
Turkey	+ 112 ★ 155	☎ TTOK (02 12) 2 82 81 40
Ukraine	+ 112 ★ 112	☎ 112 UA (0 32) 2 97 01 12
Hungary	+ 112 ★ 112	☎ MAK (01) 3 45 18 00
Cyprus	+ 112 ★ 112	☎ CAA (0 22) 31 32 33

¹⁾ In the mobile communication network

Date 07/2014

Specifications without guarantee

17.3 Traffic rules for motorhomes

For your information, the speed limits (in km/h), alcohol limits and daylight running light requirements in the most-visited countries are the following:

Country	Speed limit in km/h					Alcohol limit	Day-time running lights compulsory
	In built-up areas	Out of town		Motorway			
	Up to/over 3.5 t ¹⁾	Up to 3.5 t	Over 3.5 t ¹⁾	Up to 3.5 t	Over 3.5 t ¹⁾		
Belgium	50	90	90	120	90	0.5	No
Bosnia-Herzegovina	50	80	80	130	80	0.3	Yes
Bulgaria	50	90	70	130/140	100	0.5	Yes
Denmark	50	80	70	130	80	0.5	Yes
Germany	50	100	80	130 ²⁾	100	0.5	No
Estonia	50	90	70	110	90	0.2	Yes
Finland	50	80/100 ³⁾	80/100 ³⁾	80/100 ³⁾	80/100 ³⁾	0.5	Yes
France	50	90 ⁴⁾	80	130 ⁴⁾	110	0.5	No
Greece	50	90-110 ⁵⁾	80	130	80	0.5	No
Great Britain	48	96	80	112	112	0.8	No
Ireland	50	60-80 ⁵⁾	60-80 ⁵⁾	120	80	0.5	No
Italy	50	90	80	130 ⁶⁾	100 ⁷⁾	0.5 ⁸⁾	Yes
Croatia	50	90 ⁹⁾	90 ⁹⁾	130 ¹⁰⁾	90	0.5 ¹¹⁾	Yes ¹²⁾
Latvia	50 ¹³⁾	90	90	90 ⁵⁾	90 ⁵⁾	0.5 ¹⁴⁾	Yes
Lithuania	50	90 ⁵⁾ 15)	80 ¹⁵⁾ 5)	110	90	0.4 ¹⁴⁾	Yes
Luxembourg	50	90	75	130 ¹⁶⁾	90	0.5 ¹⁴⁾	No
Macedonia	50 ⁵⁾	80	80	80	80	0.5 ¹⁷⁾	Yes
Montenegro	50	80	80	100 ¹⁸⁾	80 ¹⁸⁾	0.3	Yes
Netherlands	50	80-100 ¹⁸⁾	80	130	80	0.5 ¹⁹⁾	No
Norway	50	80-100 ¹⁸⁾	80	90-110 ⁵⁾	80	0.2	Yes
Austria	50	100	70	110-130 ⁵⁾	80	0.5 ²⁰⁾	No

Country	Speed limit in km/h					Alcohol limit	Day-time running lights compulsory
	In built-up areas	Out of town		Motorway			
	Up to / over 3.5 t ¹⁾	Up to 3.5 t	Over 3.5 t ¹⁾	Up to 3.5 t	Over 3.5 t ¹⁾		
Poland	50 ²¹⁾	90-100 ⁵⁾ 18)	70-80 ⁵⁾	140	80	0.2	Yes
Portugal	50	90-100 ⁵⁾	70-90 ⁵⁾	120	110	0.5 ²²⁾	No
Romania	50	80-90 ¹⁸⁾ 23)	80-90 ¹⁸⁾ 23)	120 ²³⁾	110 ²³⁾	0.0	Yes
Sweden	_ ⁵⁾	_ ⁵⁾	_ ⁵⁾	_ ⁵⁾	_ ⁵⁾	0.2	Yes
Switzerland	50	80-100 ¹⁸⁾	80-100 ¹⁸⁾	120	100	0.5	Yes
Serbia	50	80	80	80	80	0.3 ²⁴⁾	Yes
Slovakia	50	90	80	130	90 ²⁵⁾	0.0	Yes
Slovenia	50	90-100 ¹⁸⁾	80	100	80	0.5 ²⁶⁾	Yes
Spain	50	80-90 ¹⁸⁾	80-90 ¹⁸⁾	100 ²⁷⁾	90 ²⁷⁾	0.5 ²⁸⁾	No
Czech Republic	50	90-130 ¹⁸⁾	80	130	80	0.0	Yes
Turkey	50	80	80	90	90	0.0	No
Ukraine	60 ¹³⁾	80 ²⁹⁾	80 ²⁹⁾	80 ²⁹⁾	80 ²⁹⁾	0.0	Yes ³⁰⁾
Hungary	50	90-110 ¹⁸⁾	70	130	80	0.0	Out of town, on motorways
Cyprus	50	65-80 ¹⁸⁾	68-80 ¹⁸⁾	100	100	0.5	No

1) Motorhomes up to 7.5 t gross weight

2) Recommended speed

3) Vehicles registered after 01/01/1995 and unladen weight up to 1875 kg, motorhomes up to 3.5 t permissible gross weight with the following equipment: ABS brakes, driver's airbag, seat belts on every seat, approved by the manufacturer for speed of 100 km/h.

4) In wet conditions in non-urban areas 80, on motorways 110 km/h

5) As signposted

6) When raining or snowing on dual expressways 90 km/h, on motorways 110 km/h

7) On motorways with green signs

8) For drivers with less than 3 years driving experience the blood alcohol limit is 0.0.

9) For drivers younger than 25 years 80 km/h generally apply.

- 10) For drivers younger than 25 years 120 km/h generally apply.
- 11) For drivers younger than 25 years, drivers of vehicles over 3.5 t and professional drivers a blood alcohol limit of 0.0 applies.
- 12) From the last Sunday in October to the last Sunday in March
- 13) 20 km/h in residential areas
- 14) For drivers holding their driving license less than 2 years, a blood alcohol limit of 0.2 applies.
- 15) On non-asphalt roads 70 km/h
- 16) 110 km/h when wet
- 17) For drivers holding their driving license less than 2 years, a blood alcohol limit of 0.0 applies.
- 18) On expressways
- 19) For drivers holding their driving license less than 5 years, a blood alcohol limit of 0.2 applies.
- 20) For drivers holding their driving license less than 2 years, a blood alcohol limit of 0.1 applies.
- 21) Between 11 p.m. and 5 a.m. 60 km/h
- 22) For drivers holding their driving license less than 3 years, a blood alcohol limit of 0.2 applies.
- 23) For drivers holding their driving license less than one year, maximum speeds reduced by 20 km/h apply out of town, on expressways and motorways.
- 24) For drivers holding their driving license less than one year, a blood alcohol limit of 0.0 applies.
- 25) 80 km/h on urban motorways
- 26) For drivers holding their driving license less than 2 years or are younger than 21 years, a blood alcohol limit of 0.0 applies.
- 27) On roads resembling motorways. In some countries, special rules apply for newly qualified drivers.
- 28) For drivers holding their driving license less than 2 years, a blood alcohol limit of 0.3 applies.
- 29) For drivers holding their driving license less than 2 years, a maximum speed of 70 km/h applies.
- 30) From October 1st to April 30th

Date 08/2014

Source: ADAC

Specifications without guarantee

17.4 Sleeping in the vehicle away from camping areas

Country	Sleeping on roads and fields		Sleeping on privately owned lands		Comments
	Yes	No	Yes	No	
Belgium		X	X		On highway rest areas max. 24 hours permitted
Bulgaria		X		X	
Denmark		X	X		
Germany	X		X		Staying overnight for one night to restore driving ability is permitted. There may be regional and local limitations

Country	Sleeping on roads and fields		Sleeping on privately owned lands		Comments
	Yes	No	Yes	No	
Finland		X		X	Possible with the permission of the land owner
France	(X)		X		Permission from the local authorities or the owner of the land is required. Parking and staying overnight on free areas is prohibited
Greece		X		X	One-off overnight stays in designated areas are permitted
Great Britain		X	X		Regulated by local rules
Ireland		X	X		Regulated by local rules
Italy	X		X		Staying overnight for one night at car parks and service stations is allowed. Observe the local regulations. Parking and staying overnight on free areas is prohibited
Croatia		X		X	
Luxembourg		X		X	
Macedonia		X		X	
Netherlands		X		X	Overnight stays on streets and squares is allowed in some boroughs
Norway	X		X		Officially prohibited on rest areas and cultivated grounds. Driving on dirt tracks prohibited; observe local regulations
Austria		X		X	Staying overnight for one night to restore driving ability is permitted, but not in nature reserves. Observe regional and local restrictions. Generally forbidden in Tyrol
Poland		X	X		Requires property owner's permission
Portugal		X		X	Staying overnight for one night on motorway service stations and car parks under 10 hours are tolerated
Romania		X		X	
Russia		X		X	
Sweden	X		X		Not on agriculture areas or in the vicinity of houses. Driving on rough terrain prohibited; observe local regulations

Country	Sleeping on roads and fields		Sleeping on privately owned lands		Comments
	Yes	No	Yes	No	
Switzerland		X	X		One overnight stay at highway rest areas and in some cantons is tolerated
Serbia and Montenegro		X		X	
Slovakia		X	X		Overnight stays on private land are only allowed if a toilet is present
Slovenia		X		X	
Spain	X		X		Some regional prohibitions apply, especially on beaches
Czech Republic		X	X		Overnight stays on private land are only allowed if a toilet is present
Turkey	X		X		
Ukraine	X		X		
Hungary		X	X		Staying overnight on privately owned land is permitted only with police certification

Specifications without guarantee

17.5 Gas supply in European countries



- ▷ In Europe, there are several different connection systems for gas bottles. It is not always possible to fill or exchange your gas bottles in a foreign country. Get information about the connection system in the country you are travelling to before embarking on your journey, e.g. at a motoring club or in the trade press.

General tips

Always observe the following instructions:

- Only go on vacation with completely filled gas bottles.
- Use all of the gas bottles' capacity.
- Take along adapter sets (available in camping supply stores) for filling gas bottles in foreign countries and for connecting the gas pressure regulator to foreign gas bottles.
- During the cold time of the year observe filling with propane gas component (butane does not gas below 0 °C).
- Use blue bottles from the firm Campingaz (distributed world-wide). Only use gas bottles with safety valves.
- When bottles from other countries are used, check the gas bottle compartments to see if the gas bottles fit into them. Gas bottles from other countries do not always display the same size as your own gas bottles.

17.6 Toll regulations in European countries

Many European countries have introduced a mandatory toll system. The toll regulations and how they are collected vary greatly from country to country. Nevertheless, ignorance is no excuse. Penalties can be quite severe.

As is the case with traffic regulations, the vehicle driver is required to be familiar with the toll formalities before starting out on a trip. For example, in Austria the vignette does not meet the toll requirements for vehicles that weigh more than 3.5 t. There, a so-called "Go-Box" must be obtained and charged.

Contact your automobile club or the Internet for further information.



- ▷ Windscreens with solar filters can affect the functioning of automatic toll collection systems (e.g. Go-Box). This must be taken into account when acquiring the appropriate device (e.g. Split-Go-Box).

17.7 Tips on staying overnight safely during travel

Prudent behaviour is the most important protective measure for insuring a safe night in the motorhome.

The risk of theft is reduced to a minimum when the following basic rules are observed:

- Before commencing the journey, close and lock all windows, doors and skylights.
- During high season do not spend the night at highway rest stops or parking areas located along typical vacation routes.
- Several vehicles on one site at the same time do not necessarily decrease the chances of theft occurring. Consult your own feelings about the parking site.
- Even if it is just for one night, go to a camping site.
- When parking on open space keep emergency routes clear. The way to the driver's seat should be clear. The ignition key should always be within reach.
- Only take with you those valuables which are absolutely necessary for the journey. If possible, store valuables in a small safe and not in the immediate vicinity of windows or doors.
- Always lock up the vehicle.

17.8 Tips for winter campers

The following tips will help make your winter camping experience as agreeable as possible.

- Reserve your parking place in good time. Good winter camping sites are often booked up early.
- Do not start your trip without winter tyres.
- Bring snow chains.
- Choose your parking place with care. Observe the ground beneath you. Snow and ice may melt.
- When the vehicle has been positioned, release the handbrake to prevent freezing.
- No snow walls should be allowed to cover the built-in forced ventilation.
- Keep the built-in forced ventilation free from snow and ice.
- Make sure the air circulation is good. Good air circulation prevents moisture from collecting and makes it easier to heat the living area.
- Cover the single-paned driver's cabin window with insulation mats to avoid thermal bridges.
- Follow the instructions in the section "Gas supply in European countries".
- Use a two-bottle system with automatic controller for the gas system, so that the supply does not run out during the night.
- Only operate the gas system using propane gas.
- Do not use the space behind the heater as a storage compartment.
- Never operate catalytic ovens or infra-red gas radiators in the interior of the vehicle, since they consume oxygen for burning.
- Lay the 230 V power cable in such a way that the cable cannot be frozen or be damaged (e.g. during snow removal).
- When it is snowing heavily, clear the roof of the vehicle of snow regularly. A few centimetres of powdery snow serves as insulation, but wet snow quickly becomes a heavy burden.
- Before embarking on the return journey, remove all the snow from the roof to avoid impeding vehicles behind you with a "snow flag".

17.9 Travel checklists

The following checklists will help that nothing important is left at home although not everything on the checklists might be necessary.



- ▷ Do not leave checking of documents (e.g. vehicle papers and information) as well as checking the condition of the vehicle until just before commencing the trip. Planning and checking documents well in advance will save unnecessary trouble.

Kitchen area

✓	Object	✓	Object	✓	Object
	Wiping cloth		Cleansing agent (detergent)		Salad servers
	Mug		Dishcloths		Chopping board
	Turnspit		Set of knives and forks for grilling		Bowls
	Can opener		Coffeepot		Brush to wash the dishes
	Egg-cup		Corkscrew		Cloth to wash the dishes
	Ice cube tray		Kitchen paper		Matches

✓	Object	✓	Object	✓	Object
	Lighter		Spoons		Cups
	Bottle opener		Knives		Plates
	Air-tight storage boxes		Garbage bags		Thermos jug
	Breakfast plate		Frying pans		Pots
	Forks		Stirring spoons		Glasses

Bathroom/sanitary items

	Towels		Toilet brush		Toothbrush glass
	Sanitary items		Toilet paper		

Living area

	Dustbin		Insect lamp		Rain clothes
	Road atlas		Insect repellent		First aid kit
	Bath towels		Deck of cards		Travel guides/parking guide
	Bath shoes		Broom		Rucksack
	Batteries		Candles		Sleeping bags
	Bed sheets		Dust pan		Pencils and paper
	Bed linen		Coat-hangers		Shoes
	Laundry bag		Clothes brush		Shoe polish
	Books		Pillow		Vacuum cleaner
	Camping guide		Map		Flash light
	Spare bulbs		Medicine		Pocket knife
	Water bottle		Music cassettes		Table cloth
	Binoculars		Neck-supporting pillow		Clothes pins
	Fire extinguisher		Sewing kit		Clothesline
	Gas bottle		Radio		

Vehicle/tools

	Waste water container		Fabric tape		Screwdriver
	Adapter socket		Watering can for drinking water		Current-measuring instrument
	CEE adapter		Cable reel		Step
	Wire		V-belt		Wheel chocks
	Spare wheel		Glue		First-aid kit
	Spare lamps		Universal pliers		Vehicle jack
	Spare fuses		Compressor		Hazard warning triangle
	Replacement water pump		Luster terminals		Warning sign
	Hammer		Loops		Warning vest(s)
	Flat wrench		Tube adapter		Flashing hazard warning light

✓	Object	✓	Object	✓	Object
	Gas filling adapter		Hose clips		
	Gas tube		Snow chains (winter)		

Outside

	Stay rope		Camping table		Lock
	Bellows		Luggage racks		String
	Camping chairs		Grill		Tent pegs/tightening ropes

Documents

	List of addresses		Registration book		Identity card
	Registration confirmation(s)		Driving licence		Passport
	Allergy certificate		Green insurance card		Writ of protection
	Instruction manuals		Vaccination certificate		Vignette/toll card
	Instruction leaflets for medicines		Credit card		Visa

Pos.	Component	Activity	Interval
1	Auxiliary support	Lubrication	Annually
2	Joints, hinges	Lubrication	Annually
3	Refrigerator, heater, boiler, cooker, lighting, flap and door closures, toilet, seat belts	Function check	Annually
4	Windows, skylights	Function check, water ingress test	Annually
5	Cushions, curtains, blinds	Visual check	Annually
6	Sealing strips, edges, rubber	Check for damage	Annually
7	Water supply	Water ingress test	Annually
8	Hot-air system	Function check, clean fan wheel as necessary	Annually
9	Underbody protection, floor skirt attachment	Visual check	Annually
10	Electrical system	Function check	Annually
11	Gas system	Official gas inspection	Every two years
12	Connections between the chassis and body	Check	Every two years
13	Underbody	Visual check, repair underbody protection as necessary	Every two years



Delivery _____	Pos. 1-10
Stamp of the Bürstner dealer	
Date	Signature

1st year _____	Pos. 1-10
Stamp of the Bürstner dealer	
Date	Signature

2nd year _____	Pos. 1-13
Stamp of the Bürstner dealer	
Date	Signature

3rd year _____	Pos. 1-10
Stamp of the Bürstner dealer	
Date	Signature

4th year _____	Pos. 1-13
Stamp of the Bürstner dealer	
Date	Signature

5th year _____	Pos. 1-10
Stamp of the Bürstner dealer	
Date	Signature

6th year _____	Pos. 1-13
Stamp of the Bürstner dealer	
Date	Signature

7th year _____	Pos. 1-10
Stamp of the Bürstner dealer	
Date	Signature

8th year _____	Pos. 1-13
Stamp of the Bürstner dealer	
Date	Signature

12 V fuses	133
For Thetford toilet	136
Heater for waste water pipes	137
On the living area battery	134
On the relay box AD01	134
On the starter battery	134
On the transformer/rectifier	135
12 V indicator lamp	121
12 V main switch	118, 122
12 V power supply	109
Switching on	118, 122
Troubleshooting	240
230 V connection	58, 132
External flap	67
Troubleshooting	239
230 V fuse	138
Position	255
230 V fuse box	138
230 V indicator lamp	122
230 V power supply	131
230 V indicator lamp	121
3-way valve	158

A

Access ladder, overcab bed	94
Accessories, fitting	10
Additional equipment	20
Additional seat	93
Add-on parts see special equipment	10
Add-on parts, securing	34
Adjustable head section, fixed bed	95
Adjustment mechanism, divan	92
Air conditioning unit (Dometic)	
Air current, adjusting	164
Care	206
LED	164
Maintenance	206
Operating modes	163
Switching off	163
Switching on	163
Troubleshooting	246
Air conditioning unit (Telair)	
Care	207
Filter, cleaning	207
Operating modes	165
Switching off	165
Switching on	165
Troubleshooting	246
Ventilation grill, cleaning	207

Air outlet nozzles, adjustment	148
AL-KO rear axle	224
Antenna alignment	59
Automatic	58
Appliances	147
Manuals	10
Warranty cards	1
Automatic power selection (AES)	181
Auxiliary heat exchanger	
Switching off	160
Switching on	160
Auxiliary water tank	188
Awning	60

B

Basic equipment	19
Battery alarm	121, 125
Battery cut-off switch	115
Battery monitor	115, 117
Battery see starter battery	
or living area battery	110, 112
Battery selector switch	115, 117
Battery separation	117
Battery voltage, displaying	119, 123
Bed extension, securing	34
Beds	93
Before the journey	17
Bench with divan, sleeping conversion	97
Bike rack	
Bicycles, loading	26, 27
Load	25
Lowerable	26
Not lowerable	27
Travelling with a loaded bike rack	25
Bike/e-bike bike rack	
Driving with loaded bike rack	27
Loading	27
Blind, cleaning	204
Blind, window	
Closing	81
Opening	81
Block diagram, panel (LT 510)	143
Boiler (Alde)	
Emptying	171
Position	255
Safety instructions	171
Switching off	171

Switching on	171	Fuel cell	204
Troubleshooting	245	Furniture surfaces	203
Water, filling with	171	Gas cooker	204
Boiler (Truma)	166, 169	High-pressure cleaner, washing with	201
Emptying	168, 170	Hot-water heater	215
Operating modes	166, 169	In the winter	207
Position	255	Insect screen	204
Safety/drainage valve	167, 170	Interior care	203
Summer operation	167	Lamps	203
Switching off	167	Leather covers	204
Switching on	167	Net curtains	204
Troubleshooting	242, 243	Pneumatic spring	203
Water, filling with	168, 170	PVC-floor covering	204
Winter operation	167	Roman shade	204
Brakes	41	Seat belt	204
Check	41, 237	Sink	204
Braking system, troubleshooting	237	Synthetic parts, interior	203
Breakdown services in Europe	259	Temporary lay-up	208
Bulbs, changing	217, 220	Underbody	202
Exterior lighting	217	Upholstery	203
Halogen ceiling lamp	220	Washing	202
Halogen spotlight	222	Waste water tank	204
Interior lighting	220	Water system	205
Rear lights	218	Windows	202
Recessed halogen light	221, 222	Winter lay-up	210
Side lights	219	Carpet, cleaning	204
Surface mounted light	223	Ceiling lamp	220
Surface-mounted LED light	221	Central locking system	61
Types of external bulbs	219	Locking	61
Wardrobe light	223	Remote control	61
Bunk bed	96	Unlocking	61
Butane gas	13, 100	Central seating group, sleeping conversion	96, 97
C		Changing wheels	229
Cable reel	132	Tightening torque	230
Camping gas bottles, use	14, 101	Charging condition, displaying	
Camping in winter	268	Living area battery	119
Cap, drinking water filler neck	67	Starter battery	119
Capacity of the battery	108	Chassis number	225
Caravan coupling	31	Checklist	35, 208
Care	201	Before the journey	35
Air conditioning unit (Telair)	207	For the journey	268
Blind	204	Initial start-up after temporary lay-up	211
Carpet	204	Road safety	35
Curtains	204	Temporary lay-up	208
Entrance step	203	Winter lay-up	210
External care	201	Child restraint systems	47
Extractor hood	206	Children's beds	93, 96

Circuit diagram		
Exterior	145	
Interior	140	
Circulating pump, setting the rotational speed	157	
Circulation fan	149, 151	
Cleaning		
Waste water tank	204	
Water pipes	205	
Water tank	205	
Cleaning see care	201	
Closed circuit current	108	
Condensation	76	
On the double acrylic glass pane	77	
On the screwed connections in the floor	76	
Condensation water see condensation	77	
Connecting cable see 230 V power supply	132	
Connection diagram, panel (IT 96)	142	
Conventional load	19	
Conversion door	61, 64	
Roman shade, closing	64	
Roman shade, opening	64	
Conversion door, inside		
Locking	62, 63	
Opening	62, 63	
Conversion door, outside		
Locking	62, 63	
Opening	62, 63	
Conversion to bed foundation (suspension table)	92	
Cooker	172	
Troubleshooting	247	
Curtains, cleaning	204	
D		
Danger of suffocation	10, 76	
Dimensions see table of linear measures	256	
Dimensions, permissible	262	
Direction indicator	218	
Displays		
Battery voltage	119, 123	
Temperature	126	
Waste water tank level	120, 125	
Water tank level	120, 125	
Disposal		
Household waste	8	
Sewage	8	
Waste water	8	
Divan adjustment mechanism	92	
Door lock	62, 63	
Doors		
Conversion door	61	
Lock	62, 63	
Maintenance work	214	
Troubleshooting	250	
Double floor, load	25	
Drain cock, waste water tank	193	
Position	255	
Drain cocks, position	171, 255	
Drinking water filler neck	189	
Closing	189	
Opening	189	
Driver's cabin partition	69	
Closing	69	
Opening	70	
Driver's seat	48	
Driving speed	40	
Driving the motorhome	39	
During the journey	39	
E		
Electrical steady legs		
Remote control	56	
Warning tone	56	
Electrical system	107	
230 V connection, troubleshooting	239	
Entrance step, troubleshooting	239	
Explanation of terms	108	
Lighting, troubleshooting	238	
Safety instructions	14	
Troubleshooting	238	
Entrance step	53	
Care	203	
Electrically operated	32	
Extending	33	
Indicator lamp	32, 33	
Retracting	33	
Troubleshooting	239	
Environmental tips	8	
Exterior lighting		
Bulbs, changing	217	
Checking	35	
Troubleshooting	238	
External care	201	
External connection see 230 V connection	58	
External flaps	65	
Flap lock	65, 66	
External gas connection	102	

Index

- External shower 98
 Connection 98
 Emptying 98
External socket 139
Extractor hood 178
 Care 206
 Filter, cleaning 206
- F**
- Fault current protection switch 132
 Check 138
Filling level of the waste water tank,
displaying 120
Filling level of the water tank, displaying 120
Filling the tank 52
Fire
 Behaviour in the event of 9
 Extinguishing 9
Fire prevention 9
Fire risks, avoidance 9
FI-switch see fault current
protection switch 138
Fixed bed 95
 Closing 95
 Head section, lowering 95
 Head section, raising 95
 Opening 95
Flap lock
 Closing 65, 66, 67
 Opening 65, 66, 67
 Service flap 66
 Square 66
 With recessed handle 65
Flat screen with holder 74
 Positioning 74, 75
 Storing 74, 75
Floor compartment 69
 Closing 69
 Opening 69
Floor warming unit, electrical
 Overload protection 161
 Switching off 161
 Switching on 161
Folding mechanism, overcab bed 94
Forced ventilation 10, 76
Front passenger's seat 48
Fuel cell
 Cleaning 204
 Components 128
 Function 128
 Instructions 127
 Maintenance 214
 Operating status, indication 128
 Operating unit 128
 Position 128
 Process medium, refilling 215
 Tank cartridge, replacing 214
 Troubleshooting 241
Fuel filler neck 52
Furniture flaps 68
 Closing 68
 Opening 68
Furniture flaps, troubleshooting 250
Furniture surfaces, cleaning 203
Fuse box 138
Fuses
 12 V fuses 133
 230 V fuse 131, 138
 For the Thetford toilet 136
 Heater for waste water pipes 137
 On the living area battery 134
 On the relay box AD01 134
 On the solar charge regulator 137
 On the starter battery 134
 On the transformer/rectifier EBL 220 135
 On the transformer/rectifier EBL 99 135
Fuses see 12 V fuses and 230 V fuse 133
- G**
- Gas bottle compartment 13, 100
Gas bottles
 Changing 101
 Safety instructions 14, 100
Gas connection, external 102
Gas cooker
 Cleaning 204
 Switching off 173, 174
 Switching on 173, 174
 Troubleshooting 247
Gas grill 173
 Switching off 175
 Switching on 175
Gas isolator taps 102
 Symbols 102, 147

Index

Indicator lamp, 12 V power supply	121	Light switch	72
Indicator lamp, 230 V power supply	121, 122	Living area	71
Indicator lamp, entrance step	33	Toilet compartment	70
Indicator lamp, toilet	199	Lighting	
Information stickers	225	Front	218
Inner door, troubleshooting	250	Lamps, cleaning	203
Inner doors	68	Rear	218
Insect screen door		Side	219
Closing	64	Troubleshooting	238
Opening	64	Lights see bulbs, changing	220
Insect screen Omni-Vent skylight		Living area battery	112
Closing	87	Battery alarm	121, 125
Opening	87	Charging	113
Insect screen, cleaning	204	Fuses	134
Insect screen, Heki skylight		Instructions	112
Closing	86	Maintenance work	214
Opening	86	Position	255
Insect screen, Skyroof skylight		Troubleshooting	239, 240
Closing	90	Voltage, displaying	119, 123
Opening	90	Load	22
Insect screen, windows		Bike rack	25
Closing	81, 82	Bike/e-bike bike rack	27
Opening	81, 82	Double floor	25
Insect screen, wind-up skylight		Rear garage	24
Closing	87	Rear storage space	24
Opening	87	Roof rack	23
Inspection plan	271	Load rack	29, 30
Inspection work	213	Load rack for roof loads	23
Inspections	213	Load see also payload	22
Interior care	203	Lock	
Interior lighting		Conversion door	62, 63
Bulbs, changing	220	External flap	65, 66
Troubleshooting	238	Furniture flap	68
K		Low beam	218
Keys	17	M	
L		Main beam	218
Ladder, overcab bed	94	Maintenance	213
Ladder, rear	23	Maintenance work	213
Lamps	220	Air conditioning unit (Dometic)	206
Cleaning	203	Air conditioning unit (Telair)	207
Lay-up		AL-KO rear axle	224
Temporary	208	Doors	214
Winter lay-up	210	Fuel cell	214
Leakage water inside the vehicle	249	Hot-water heater	215
Leather covers, cleaning	204	Independent vehicle heater	217
Light control	72	Living area battery	214
		Marker light	219
		Mass in ready-to-drive condition	19, 21

Maximum permissible gross weight	18, 21
Mechanical steady legs	
Extending	54, 55
Length, adjustment	54, 55
Retracting	55
Microwave oven	
Switching off	177
Switching on	177
Troubleshooting	247
Monitor, reversing camera	40

N

Net curtains, cleaning	204
No gas	241
Nose weight	31

O

Off-load voltage	108
Omni-Vent skylight	
Aerating	88
Boost function	88
Fan, switching off	87, 88
Venting	88
Operating modes	
Air conditioning unit (Dometic)	163
Air conditioning unit (Telair)	165
Boiler (Truma)	166, 169
Hot-air heater	149
Hot-water heater	156
Refrigerator	179, 181
Operating unit, hot-air heater	151
Oven see gas cooker	
or gas oven	172, 173, 175
Overcab bed	93
Access ladder	94
Folding downwards	94
Folding mechanism	94
Folding upwards	94
Safety net	94
Overloading	22

P

Panel (IT 96)	118
12 V indicator lamp	121
12 V main switch	118
230 V indicator lamp	121
Battery voltage, displaying	119
Connection diagram	142

Filling level of the waste water tank, displaying	120
Filling level of the water tank, displaying	120
Switch for water pump	121
Panel (light control)	72
Panel (LT 510)	121
12 V main switch	122
230 V indicator lamp	122
Alarms	125
Battery displays	123
Block diagram	143
Tank display	125
Tank heater switch	126
Temperature display	126
Water pump switch	127
Panel see also displays	118
Parking light	218
Payload	18
Calculation	20
Composition	19
Example calculation	19, 21
Payload see also load	18
Permissible gross weight see maximum permissible gross weight	18
Permitted mass	18
Personal equipment	20
Pilot seat see driver's seat and front passenger's seat	48
Pleated Roman shades	51
Pneumatic spring	41, 42
Care	203
Front and rear axle	44
Functions	42, 45
Remote control	42, 44
Safety instructions	41
Troubleshooting	237
Power supply	257
Propane gas	13, 100
PVC-floor covering, cleaning	204

R

Radio	110
Ramps	53
Rear axle load	31
Rear garage	24
Rear ladder	23
Rear storage space	24
Recessed halogen light	222

Shade Omni-Vent skylight		Instructions	110
Closing	87	Troubleshooting	239
Opening	87	Voltage, displaying	119, 123
Shower	196	Start-up	
Shower connection point, external shower	98	After temporary lay-up	211
Shower partition, securing	34	After winter lay-up	211
Side marker light	219	Staying overnight	
Sink, cleaning	204	Away from camping areas	264
Skylight Omni-Vent	87	During travel	267
Closing	87	Steady legs	54, 55
Opening	87	Extending	54, 55
Skylights	84	Length, adjustment	54, 55
Troubleshooting	250	Retracting	55
Skyroof skylight	88	Supports see steady legs	54, 55
Closing	89	Surface mounted light	223
Continuous ventilation	89	Suspension table	
Insect screen	90	Conversion to bed foundation	92
Opening	88	Extending	91
Roman shade	90	Reducing size	91
Sleeping conversion, bench with divan	97	Table leg	90
Sleeping conversion,		Table top	90
central seating group	96, 97	Switching automatics, gas system	103
Snow chains	35	Symbols	
Sockets		For instructions	7
External socket	139	Gas isolator taps	102, 147
SAT socket	139	Synthetic parts in the toilet	
TV socket	139	and living areas, cleaning	203
USB socket	109		
Solar charge regulator	130	T	
Solar installation	130	Table of linear measures	256
Spare parts	224	Tank alarm	125
Spare wheel	233	Tank heater, switching on and off	126
Spare wheel support	233	Tank lid see fuel filler neck	52
Special equipment	251	Technical data	
Description	7	Dimensions	256
Marking	7	Power supply	257
Safety instructions	10	Television	33
Weight details	251	Temperature display	126
Speed limits	262	Theftford toilet	
Spotlight	72, 221	Flushing	199
Removing	72	Indicator lamp	199
Shifting	72	Tightening torque, wheels	230
Turning	72	Tips	259
Starter battery	110	Toilet	197
Battery alarm	125	Flushing	199
Charging	111	Fuse	136
Discharging	110	Indicator lamp	199
Fuses	134	Preparing	197
		Troubleshooting	249

Toilet compartment	196	Starter battery	239
Light switch	70	Toilet	249
Ventilation	196	Water supply	249
Toilet see also Thetford toilet	197	TV socket	139
Toll regulations in European countries	267	Tyre change see changing wheels	229
Total discharge	108	Tyre specifications	229
Towing	12	Tyres	227
General instructions	31	Excessive wear	11, 35, 227, 234
Safety instructions	12	General instructions	227
Traffic rules in foreign countries	259	Handling	229
Transformer/rectifier (EBL 220)	116	Identification	229
Circuit diagram	141	Load-carrying capacity	230
Functions	116	Tyre pressure	234
Position	117	Tyre selection	228
Transformer/rectifier (EBL 99)	113		
Circuit diagram	140	U	
Functions	114	Underbody, maintenance	202
Position	114	Unladen weight	19
Transformer/rectifier, position	255	Upholstery, cleaning	203
Travel checklists	268	USB socket	109
Travel cots suitable for children	93, 96		
Troubleshooting	237	V	
12 V power supply	240	Vehicle identification plate	225
230 V connection	239	Vehicle lighting see exterior lighting	217
Air conditioning unit (Dometic)	246	Vehicle, washing	202
Air conditioning unit (Telair)	246	Ventilation	76
Battery	239	Toilet compartment	196
Body	250	Volume of waste water, displaying	120, 125
Boiler (Alde)	245	Volume of water, displaying	120, 125
Boiler (Truma)	242, 243		
Braking system	237	W	
Cooker	247	Wardrobe light	71, 223
Electrical system	238	Warning stickers	225
Entrance step	239	Warning tone, electrical steady legs	56
Extractor hood	241	Warranty cards	1
Fuel cell	241	Washing with a high-pressure cleaner	201
Furniture flaps	250	Waste gas vent on the right hand side of the vehicle.	148, 166
Gas cooker	247	Waste water hose	194
Gas oven	247	Waste water tank	193
Gas system	241	Care	204
Heater	242	Cleaning	204
Hot-air heater	242, 243	Cleaning opening	193
Hot-water heater	245	Emptying	194
Inner door	250	Filling level, displaying	120, 125
Lighting	238	Heater	195
Living area battery	239	Troubleshooting	249
Microwave oven	247	Water pipes, cleaning	205
Pneumatic spring	237		
Refrigerator	247		

Water pump	187, 189
Position	255
Switch	121
Switching on and off	127
Water supply	
General	187
Troubleshooting	249
Water system	188
Care	204, 205
Cleaning	204, 205
Disinfect	206
Drinking water filler neck	189
Emptying	192
Filling	189
Safety instructions	14
Water tank	
Cleaning	205
Filling level, displaying	120, 125
Overflow	191
Position	255
Volumes	188
Water, draining	191
Water, refilling	191
Weight details for special equipment	251
Wheel chocks	53
Wheel rim size	230
Wheel rim type	227
Wheels	227
Window, conversion door	
Roman shade, closing	64
Roman shade, opening	64
Windows	76
Blind	81
Cleaning	202
Insect screen	81, 82
Roman shade	82, 83
Shade	83
Wind-up skylight	86
Closing	86
Insect screen	86
Opening	86
Roman shade	86
Winter care	207
Winter operation	208

