

Dear Reader ...

We would like to congratulate you on the purchase of your new motorhome. You have selected a top-quality vehicle which will afford you many years of enjoyment.

To enable you to always use and operate your motorhome properly and easily, your Bürstner dealer will first provide you detailed instructions for all important functions when you take delivery.

This manual, the instruction manuals from the base vehicle manufacturer as well as the instruction manuals from the appliance manufacturer will always be at hand to answer any questions you may have regarding your motorhome.

Before your first journey

Please familiarise yourself with this manual rather than relying on it strictly for reference.

Fill in the warranty cards for the appliances and special equipment in the individual instructions and send these cards to the respective manufacturers. This ensures your warranty claim for each appliance.

1	Introduction	7	4.8	Pilot seats for the driver's and front passenger's seats	40
1.1	General	7	4.9	Headrests	40
1.2	Environmental tips	8	4.10	Seating arrangement	41
2	Safety	9	4.11	Roman shades in the driver's cabin (partially special equipment)	41
2.1	Fire prevention	9	4.12	Filling up with diesel	42
2.1.1	Avoidance of fire risks	9	5	Pitching the motorhome	43
2.1.2	Fire-fighting	9	5.1	Handbrake	43
2.1.3	In case of fire	9	5.2	Entrance step	43
2.2	General	10	5.3	Ramps	43
2.3	Road safety	10	5.4	Wheel chocks	43
2.4	Towing	12	5.5	Supports	44
2.5	Gas system	12	5.5.1	General instructions	44
2.5.1	General instructions	12	5.5.2	Steady legs (SAWIKO) (special equipment)	44
2.5.2	Gas bottles	13	5.5.3	Steady legs (AL-KO) (special equipment)	45
2.6	Electrical system	14	5.5.4	Electrical steady legs (AL-KO) (special equipment)	46
2.7	Water system	14	5.6	230 V connection	48
3	Before the journey	15	5.7	Refrigerator	48
3.1	Keys	15	5.8	Satellite unit (special equipment)	48
3.2	Registration	15	5.8.1	Equipment with automatic antenna alignment (Alden)	48
3.3	Payload	16	5.8.2	Equipment with semi-automatic antenna alignment (Alden)	49
3.3.1	Terms	16	5.8.3	Equipment with automatic antenna alignment (Oyster)	50
3.3.2	Calculating the payload	18	5.9	Awning (special equipment)	50
3.3.3	Loading the vehicle correctly	19	6	Living	53
3.3.4	Roof rail and ladder (partially special equipment)	21	6.1	Conversion door	53
3.3.5	Rear garage/rear storage space	22	6.1.1	Conversion door, outside (Hartal M1)	53
3.3.6	Bike rack (special equipment)	23	6.1.2	Conversion door, inside (Hartal M1)	54
3.3.7	Removable load rack AL-KO (special equipment)	25	6.1.3	Conversion door, outside (Hartal Premium) (partially special equipment)	54
3.3.8	Load rack SAWIKO (special equipment)	26	6.1.4	Conversion door, inside (Hartal Premium) (partially special equipment)	55
3.4	Towing	27	6.1.5	Window of conversion door (Hartal Premium) (partially special equipment)	55
3.5	Caravan coupling (special equipment)	28	6.1.6	Folding insect screen on the conversion door (partially special equipment)	55
3.6	Entrance step	28	6.2	External flaps	56
3.6.1	Free-standing entrance step	28	6.2.1	Flap lock with recessed handle	56
3.6.2	Electrically operated entrance step (partially special equipment)	29	6.2.2	Flap lock with push button	57
3.7	Television (special equipment)	30	6.2.3	Flap for the 230 V connection, square	57
3.8	Sink and drain basin covers	31	6.2.4	Cap for the drinking water filler neck	58
3.9	Securing add-on parts	31			
3.10	Snow chains (special equipment)	32			
3.11	Road safety	32			
4	During the journey	35			
4.1	Driving the motorhome	35			
4.2	Parking distance control Park Boy V (special equipment)	36			
4.3	Reversing camera (special equipment)	37			
4.4	Driving speed	38			
4.5	Brakes	38			
4.6	Seat belts	39			
4.6.1	Fastening the seat belt correctly	39			
4.7	Child restraint systems	39			

Contents

6.3	Furniture flaps	58	6.12.6	Pull-down bed, electrically operated (special equipment, Ixeo)	88
6.3.1	Furniture flaps with push button	58	6.12.7	Step, foldable	91
6.3.2	Furniture flaps with handle and push button	59	6.12.8	Widening single beds (special equipment)	92
6.3.3	Furniture flaps with release handle	59	6.13	Converting seating groups for sleeping	92
6.4	Light switch	59	6.13.1	Small central seating group	95
6.4.1	Entrance area	59	6.13.2	Central seating group with bed widening	96
6.4.2	Interior	60	6.13.3	Seating group with vario seat	97
6.4.3	Wardrobe light	61	6.13.4	Central bench with divan	98
6.5	Spotlight	61	6.13.5	Central bench with divan (with bed widening)	99
6.6	Holder for flat screen	62	6.13.6	Central bench with divan (Van)	100
6.6.1	Holder on the column	63	6.13.7	L-shaped bench with divan	101
6.6.2	Holder with jointed arm	63	6.13.8	L-shaped bench with divan (with bed widening)	102
6.6.3	Holder in the TV cabinet	64	6.13.9	L-shaped bench with lengthwise seat (with additional cushion)	103
6.6.4	Holder in the TV compartment	64	6.13.10	L-shaped bench (long) with divan	104
6.7	Ventilation	65	6.13.11	L-shaped bench (long) with divan (wide)	105
6.8	Windows	65	6.13.12	L-shaped bench with divan	106
6.8.1	Hinged window with rotary hinges	66	7	Gas system	107
6.8.2	Hinged window with automatic hinges	67	7.1	General	107
6.8.3	Blind and insect screen	69	7.2	Gas bottles	108
6.8.4	Roman shade and insect screen	70	7.3	Changing gas bottles	109
6.8.5	Roman shade and insect screen	70	7.4	Gas isolator taps	110
6.8.6	Roman shades for windscreen, driver's window and front passenger's window (partially special equipment)	71	7.5	External gas connection (special equipment)	110
6.9	Skylights	73	7.6	Crash protection unit switching facility (special equipment)	111
6.9.1	Heki skylight (mini and midi) (partially special equipment)	73	7.7	DuoControl switching facility (special equipment)	113
6.9.2	Wind-up skylight (special equipment)	75	7.8	Gas alarm system (special equipment)	114
6.9.3	Skyroof skylight (partially special equipment)	76	8	Electrical system	117
6.10	Tables	78	8.1	General safety instructions	117
6.10.1	Suspension table with separable support leg	78	8.2	Terms	117
6.10.2	Suspension table with changeable table leg	78	8.3	12 V power supply	118
6.10.3	Suspension table with changeable table leg (without table-top extension)	80	8.3.1	Selector switch for radio (special equipment)	118
6.10.4	Lift-off table	80	8.3.2	Starter battery	119
6.10.5	Fixed table (extendable table-top)	81	8.3.3	Living area battery	120
6.10.6	Fixed table (movable table-top)	82	8.4	Transformer/rectifier (EBL 99)	121
6.10.7	Fixed table (table-top for folding, sliding and rotating)	82	8.4.1	Battery cut-off switch	123
6.11	Divan adjustment mechanism (special equipment)	83	8.4.2	Battery selector switch	123
6.12	Beds	84	8.4.3	Battery monitor	123
6.12.1	Fixed bed (gas-pressure springs)	84	8.4.4	Charging the battery	123
6.12.2	Fixed bed (adjustable head section)	84	8.5	Panel IT 96-2	124
6.12.3	Fixed bed, electrically adjustable	85	8.5.1	12 V main switch	124
6.12.4	Bunk bed	86	8.5.2	V/tank gauge for battery voltage and water or waste water levels	124
6.12.5	Pull-down bed, manually operated (Ixeo)	86	8.5.3	Switch for water pump	126

8.5.4	Battery alarm for the living area battery	126	9.4.3	Truma Combi boiler D	165
8.5.5	12 V indicator lamp	127	9.4.4	Alde boiler (special equipment)	167
8.5.6	230 V indicator lamp	127	9.5	Cooker	168
8.6	Panel IT 994	127	9.5.1	Gas cooker	168
8.6.1	V/tank gauge for battery voltage and water or waste water levels	127	9.5.2	Gas oven (Dometic) (special equipment)	170
8.6.2	Battery alarm for the living area battery	129	9.5.3	Microwave oven (special equipment)	171
8.6.3	Digital clock/temperature gauge	129	9.5.4	Extractor hood (special equipment)	173
8.6.4	Current gauge for charging/discharging the living area battery	130	9.6	Refrigerator	173
8.6.5	12 V main switch	130	9.6.1	Refrigerator ventilation grill	174
8.6.6	12 V indicator lamp	131	9.6.2	Operation (Dometic 8 series with manual power selection MES)	174
8.6.7	230 V indicator lamp	131	9.6.3	Operation (Dometic 8 series with automatic power selection AES)	176
8.6.8	Switch for water pump	131	9.6.4	Operation (Thetford with SES)	178
8.7	Fuel cell (EFOY) (special equipment)	131	9.6.5	Refrigerator door locking mechanism	180
8.8	Solar installation (special equipment)	134	10	Sanitary fittings	183
8.9	230 V power supply	135	10.1	Water supply, general	183
8.9.1	230 V connection	136	10.2	Water tank	184
8.9.2	Connecting 230 V power supply	136	10.2.1	Volumes	184
8.10	Fuses	137	10.2.2	Drinking water filler neck with cap	184
8.10.1	12 V fuses	137	10.2.3	Closing/opening the overflow	185
8.10.2	230 V fuse	141	10.2.4	Filling with water	185
8.11	External socket (special equipment)	142	10.2.5	Draining water (handle with overflow)	185
8.12	Circuit diagrams	143	10.3	Waste water tank	186
8.12.1	Circuit diagrams, interior	143	10.3.1	Draining waste water	186
8.12.2	Circuit diagram, exterior	146	10.3.2	Waste water tank heater (special equipment)	187
9	Appliances	147	10.4	Filling the water system	187
9.1	General	147	10.5	Emptying the water system	188
9.2	Heater	148	10.6	Toilet compartment	189
9.2.1	Models with waste gas vent on the right-hand side of the vehicle	148	10.7	Toilet	190
9.2.2	To heat properly	148	10.7.1	Swivel toilet (Thetford C-200)	190
9.2.3	Truma Combi hot-air heater	149	10.7.2	Toilet with fixed seat (Thetford C-402)	196
9.2.4	Truma Combi hot-air heater D	151	10.7.3	Toilet (Dometic)	200
9.2.5	Alde hot-water heater (special equipment)	152	11	Care	203
9.2.6	Auxiliary heat exchanger (partially special equipment)	156	11.1	External care	203
9.2.7	Electrical floor warming unit (special equipment)	157	11.1.1	General	203
9.2.8	Independent vehicle heater (special equipment)	158	11.1.2	Washing with a high-pressure cleaner	203
9.3	Air conditioning unit (special equipment)	159	11.1.3	Washing the vehicle	204
9.3.1	Dometic	159	11.1.4	Windows of acrylic glass	204
9.3.2	Telair	160	11.1.5	Underbody	204
9.4	Boiler	162	11.1.6	Waste water tank	205
9.4.1	Models with waste gas vent on the right-hand side of the vehicle	162	11.1.7	Entrance step	205
9.4.2	Truma Combi boiler	162	11.2	Interior care	205
			11.3	Water system	206
			11.3.1	Cleaning the water tank	206
			11.3.2	Cleaning the water pipes	206
			11.3.3	Disinfecting the water system	207

Contents

11.4	Extractor hood	208	13.6	Spare wheel support (special equipment)	233
11.5	Air conditioning unit	208	13.7	Tyre pressure	233
11.5.1	Dometic	208	14	Troubleshooting	235
11.5.2	Telair	208	14.1	Braking system	235
11.6	Winter care	209	14.2	Electrical system	235
11.6.1	Preparations	209	14.3	Fuel cell	237
11.6.2	Winter operation	209	14.4	Gas system	238
11.6.3	At the end of the winter season	210	14.5	Heater/boiler	238
11.7	Lay-up	210	14.5.1	Truma heater/boiler (gas heater)	238
11.7.1	Temporary lay-up	210	14.5.2	Truma heater/boiler (diesel heater)	239
11.7.2	Winter lay-up	211	14.5.3	Alde heater/boiler	240
11.7.3	Starting up the vehicle after a temporary lay-up or after lay-up over winter	212	14.6	Air conditioning unit	241
12	Maintenance	215	14.6.1	Dometic	241
12.1	Inspection work	215	14.6.2	Telair	241
12.2	Maintenance work	215	14.7	Cooker	242
12.3	Doors	215	14.7.1	Gas cooker/gas oven	242
12.4	Living area battery	216	14.7.2	Microwave oven	242
12.5	Fuel cell	216	14.8	Refrigerator	243
12.5.1	Replacing the tank cartridge	216	14.8.1	Dometic 8 series with MES	243
12.5.2	Refilling service fluid	217	14.8.2	Dometic 8 series with AES	244
12.6	Alde hot-water heater	217	14.9	Thetford refrigerator	244
12.6.1	Checking the fluid level	218	14.10	Water supply	246
12.6.2	Topping up heating fluid	218	14.11	Body	247
12.6.3	Bleeding the heating system	218	15	Special equipment	249
12.7	Independent vehicle heater	219	15.1	Weight details for special equipment	249
12.8	Replacing bulbs, external	219	16	Technical data	253
12.8.1	Front lights	220	16.1	View of ground plans	253
12.8.2	Rear lights	220	16.2	Table of linear measures	261
12.8.3	Side lights	220	16.3	Power supply	262
12.8.4	Types of bulbs for exterior lighting	221	17	Helpful notes	263
12.9	Replacing bulbs, internal	221	17.1	Traffic rules in foreign countries	263
12.9.1	Recessed halogen light	222	17.2	Help on Europe's roads	263
12.9.2	Recessed halogen light (flat)	222	17.3	Speed limits and permissible dimensions	265
12.9.3	Recessed light with LED	223	17.4	Driving with low beam in European countries	268
12.9.4	Halogen spotlight (movable)	223	17.5	Sleeping in the vehicle away from camping areas	268
12.9.5	Halogen spotlight (movable)	224	17.6	Gas supply in European countries	270
12.9.6	Wardrobe light	224	17.7	Toll regulations in European countries	270
12.9.7	Garage light	225	17.8	Tips on staying overnight safely during travel	271
12.10	Spare parts	225	17.9	Tips for winter campers	271
12.11	Vehicle identification plate	226	17.10	Travel checklists	272
12.12	Warning and information stickers	226	18	Inspection plan	275
13	Wheels and tyres	227			
13.1	General	227			
13.2	Tyre selection	228			
13.3	Tyre specifications	229			
13.4	Handling of tyres	229			
13.5	Changing wheels	229			
13.5.1	General instructions	229			
13.5.2	Tightening torque	230			
13.5.3	Changing a wheel	232			

Please read this instruction manual completely before using the vehicle for the first time!

Always keep this instruction manual in the vehicle. Also inform all other users of the safety regulations.



- ▶ The non-observance of this symbol can lead to personal injury.



- ▷ The non-observance of this symbol can lead to damage being caused to, or inside the vehicle.



- ▷ This symbol indicates recommendations or special aspects.



- ▷ This symbol indicates actions which lead to environmental awareness.

This instruction manual contains sections which describe model-specific equipment or special equipment. These sections are specially marked. It may be that your vehicle has not been fitted with this special equipment. In some cases, the actual equipment of your vehicle may therefore be different from that shown in some illustrations and descriptions.

However, your vehicle may be fitted with other special equipment not described in this instruction manual.

Special equipment is described when an explanation is required.

Adhere to the instruction manuals which are separately enclosed.



- ▷ The details "right", "left", "front" and "rear" always refer to the vehicle in direction of travel.
- ▷ All dimensions and weight details are "approximate".

Should the vehicle be subjected to damage due to a failure to follow the instructions in this instruction manual, then the guarantee claim is deemed invalid.

Our vehicles are subjected to continuous development. Please understand that we reserve the right to alter the form, equipment and technology. Therefore, no claims can be made against the manufacturer as a result of the contents of this instruction manual. The equipment which was known and included at the time of going to press is described.

The reprinting, translation and copying, including extracts is not permitted without prior written authorisation from the manufacturer.

1.1 General

The vehicle is constructed in accordance with the latest technology and the recognised safety regulations. Nevertheless, personal injury may result and the vehicle may be damaged if the safety instructions in this instruction manual are not followed.

Only use the vehicle in a technically impeccable condition. Follow the instructions in the instruction manual.

Malfunctions which impair the safety of persons or the vehicle should be immediately remedied by qualified personnel. To avoid further damages, observe the duty to avert, minimize or mitigate loss for the user during faults.

Have the vehicle's braking and gas systems inspected and repaired by an authorised specialist workshop only.

Alterations to the body are only to be carried out with the authorisation of the manufacturer.

The vehicle is designed for the exclusive transport of persons. Luggage and accessories may only be transported up to the maximum permissible gross weight.

Observe the test and inspection periods stipulated by the manufacturer.

1.2 Environmental tips



- ▷ Be considerate of the environment.
- ▷ Remember that: All kinds of waste water and household waste are not to be disposed of in drains or in the open countryside.
- ▷ On board, collect waste water only in the waste water tank or – if necessary – in other containers designed for that purpose.
- ▷ Only empty the waste water tank and toilet cassette or sewage tank at disposal stations at the camping or caravan sites, which are especially provided for this purpose. When stopping in towns and communities, observe the instructions at caravan sites or ask where there are disposal stations.
- ▷ Empty waste water tank as often as possible, even when it is not completely full (hygiene).
If possible, flush out waste water tank and, if necessary, drainage pipe with fresh water every time it is emptied.
- ▷ Never allow the toilet cassette or sewage tank to become too full. Empty the toilet cassette or sewage tank frequently, at the latest as soon as the level indicator lights up.
- ▷ Separate household waste according to glass, tin cans, plastic and wet waste also when on a journey. Enquire at the town or community authority about disposal points. Household waste is not to be disposed of in waste paper baskets which are situated at car parks.
- ▷ Empty waste bins as often as possible into the containers provided for this purpose. This helps to avoid unpleasant smells and an accumulation of rubbish on board.
- ▷ When parked, do not allow the engine to run more than necessary. When running idle, a cold engine releases more contaminants than usual. The running temperature of the engine is achieved more quickly whilst the vehicle is in motion.
- ▷ Use an environmentally-friendly WC chemical agent for the WC which can also be biologically degraded and only use small doses.
- ▷ When staying in towns and communities for long periods, search for parking areas which are specially reserved for motorhomes. Enquire at the town or community authority about parking spaces.
- ▷ Always leave the parking places in a clean condition.

Chapter overview

This chapter contains important safety instructions. The safety instructions are for the protection of persons and property.

The instructions address the following topics:

- fire prevention and what to do in case of fire
- general care of the vehicle
- road safety of the vehicle
- towing
- gas system of the vehicle
- electrical system of the vehicle
- water system of the vehicle

2.1 Fire prevention

2.1.1 Avoidance of fire risks



- ▶ Never leave children in the vehicle unattended.
- ▶ Keep flammable materials clear of heating and cooking appliances.
- ▶ Lights can get very hot. When the light is switched on, there must always be a safety distance of 30 cm between light and flammable objects. Fire hazard!
- ▶ Never use portable heating or cooking appliances.
- ▶ Only authorised qualified personnel may make changes to the electrical system, gas system or appliances.

2.1.2 Fire-fighting



- ▶ Always carry a dry powder fire extinguisher in the vehicle. The fire extinguisher must be approved, tested and close at hand.
- ▶ Have the fire extinguisher tested at regular intervals by authorised qualified personnel. Observe the date of testing.
- ▶ Depending on the equipment, the fire extinguisher is included in the scope of delivery.
- ▶ Always keep a fire blanket near the cooker.

2.1.3 In case of fire



- ▶ Evacuate all passengers.
- ▶ Cut off the electrical power supply and disconnect from the mains.
- ▶ Close regulator tap on the gas bottle.
- ▶ Sound the alarm and call the fire brigade.
- ▶ Fight the fire if this is possible without risk.



- ▷ Acquaint yourself with the position and operation of the emergency exits.
- ▷ Keep escape routes clear.
- ▷ Observe the fire extinguisher instructions for use.

All windows and doors which meet the following requirements are considered as emergency exits:

- Open to the outside or can be shifted in horizontal direction
- Opening angle at least 70°
- Minimum diameter of clearance = 450 mm
- Maximum distance from the vehicle floor = 950 mm

2.2 General



- ▶ The oxygen in the vehicle interior is used up by breathing and the use of gas operated appliances. That is why the oxygen needs to be replaced on a constant basis. For this purpose, forced ventilation options (e.g. skylights with forced ventilation, mushroom-shaped vents or floor vents) are fitted to the vehicle. Never cover or block forced ventilations from the inside or outside with objects such as e.g. a winter mat. Keep forced ventilations clear of snow and leaves. There is a danger of suffocation due to increased CO₂ levels.
- ▶ Observe the headroom of the doors.



- ▷ As far as the fitted appliances (heater, cooker, refrigerator, etc.) and the base vehicle (engine, brakes, etc.) are concerned, the instruction manuals are authoritative. It is imperative that they be observed.
- ▷ Fitting accessories or special equipment can alter the dimensions, weight and road behaviour of the vehicle. Some of the parts must be entered in the vehicle papers.
- ▷ Only use wheel rims and tyres which are approved for the vehicle. Information concerning the size of the approved wheel rims and tyres is included in the vehicle documents or can be obtained from authorised dealers and service centres.
- ▷ Firmly apply the handbrake when parking the vehicle.
- ▷ If the maximum permissible gross weight of the vehicle exceeds 4 tonnes, wheel chocks must be used when parking on gradients. The wheel chocks are provided as standard for vehicles with a maximum permissible gross weight exceeding 4 tonnes.



- ▷ When leaving the vehicle, it is imperative that all doors, external flaps and windows are closed.
- ▷ Carry a hazard warning triangle and a first-aid kit and/or flashing hazard warning light when this is required by law.
- ▷ The vehicle may only be driven by drivers who hold a driving licence which is valid for the respective vehicle class.
- ▷ When selling the vehicle, hand over all instruction manuals for the vehicle and the fitted appliances.

2.3 Road safety



- ▶ Before commencing the journey, carry out a functional check of indicating and lighting equipment, the steering and the brakes.
- ▶ If the vehicle has been stationary for a long period (approx. 10 months) have the braking and gas systems checked by an authorised specialist workshop.



- ▶ Before commencing the journey and after short interruptions of the journey, ensure that the entrance step is completely retracted.
- ▶ Before commencing the journey, secure the hinged pull-down bed.
- ▶ Before commencing the journey, open and secure the shades on the windscreen and on the driver's and front passenger's windows.
- ▶ Before commencing the journey, remove the television from the support and store it securely.
- ▶ Before commencing the journey, place and secure the flat screen and screen support in the initial position. If the screen holder is installed in a TV cabinet: Close TV cabinet.
- ▶ Before commencing the journey, take off the loose sink and drain basin covers and store them securely in the kitchen unit or the wardrobe.
- ▶ Before commencing the journey, fix adjustable tables.
- ▶ Before commencing the journey, rotate all swivel seats in the direction of travel and lock in position. During the journey, the swivel seats must remain locked in place in the direction of travel.
- ▶ During the journey, persons are only to sit on the permitted seats (see chapter 4). The authorised number of seats is stipulated in the vehicle documents.
- ▶ Seat belts must be worn by all passengers.
- ▶ Fasten your seat belts before the beginning of the journey and keep them fastened during the journey.
- ▶ Always secure children with the children safety equipment prescribed for the respective height and weight.
- ▶ Factory-set three-point safety belts must be used when attaching child restraint systems.
- ▶ The base vehicle is a commercial vehicle (small truck). Adjust your driving technique accordingly.
- ▶ In case of underpasses, tunnels or similar obstacles, note the total height of the vehicle (including the roof load).
- ▶ In winter, the roof must be free of snow and ice before commencing the journey.
- ▶ Check tyre pressure before a journey or every 2 weeks. Wrong tyre pressure causes excessive wear and can lead to damage or even to tyre burst. You can lose control of the vehicle.
- ▶ Do not operate the heater at petrol stations. Danger of explosion!
- ▶ Do not operate the heater in closed spaces. Danger of suffocation!



- ▷ Before commencing the journey, distribute the payload evenly within the vehicle (see chapter 3).
- ▷ When loading the vehicle and when taking a rest from driving, in order to load luggage or food, for example, observe the maximum permissible gross weight and axle loads (refer to vehicle documents).
- ▷ Before commencing the journey, ensure that all cupboard doors, the toilet compartment door and all drawers and flaps are secure. Engage the refrigerator door securing device.
- ▷ Before commencing the journey, close windows and skylights.
- ▷ Before commencing the journey, close all external flaps and lock them.



- ▷ Before commencing the journey, remove the external supports and retract the corner steadies or steady legs, which are fitted to the vehicle.
- ▷ Before commencing the journey, put the antenna in park position.
- ▷ During the initial journey and each time after changing a wheel, re-tighten the wheel bolts/wheel nuts after 50 km (30 miles). Subsequently inspect them at regular intervals in order to ensure that they are firmly seated. See chapter 13 for tightening torque.
- ▷ Tyres may not be older than 6 years as the material becomes brittle over time (see chapter 13).
- ▷ When using snow chains, the tyres, wheel suspension and steering are subjected to an additional load. When using snow chains, drive slowly (maximum speed 50 km/h) and only on streets which are completely covered with snow. Otherwise the vehicle could be damaged.

2.4 Towing



- ▶ Care is to be taken when connecting and detaching a trailer. Risk of accident and injury!
- ▶ No persons are to be between the towing vehicle and the trailer during positioning for connecting and detaching.

2.5 Gas system

2.5.1 General instructions



- ▶ Before commencing the journey, when leaving the vehicle or when gas equipment is not in use, close all gas isolator taps and the main isolator tap on the gas bottle.
- ▶ No appliance operated by a naked flame (e.g. heater or refrigerator) may be in operation when filling the tank, on ferries or in the garage. Danger of explosion!
- ▶ Do not use appliances operated with a naked flame in closed spaces (e.g. garages). Danger of poisoning and suffocation!
- ▶ Only have the gas system maintained, repaired or altered by an authorised specialist workshop.
- ▶ Have the gas system checked by an authorised specialist workshop according to the national regulations before commissioning. This also applies for not registered vehicles. For modifications to the gas system have the gas system immediately checked by an authorised specialist workshop.
- ▶ The gas pressure regulator and exhaust gas pipes must also be inspected. The gas pressure regulator has to be replaced after 10 years at the latest. The vehicle owner is responsible for seeing that this is carried out.
- ▶ In case of a defect of the gas system (gas odour, high gas consumption) there is danger of explosion! Close regulator tap on the gas bottle immediately. Open doors and windows and ventilate well.
- ▶ If the gas system is defective: Do not smoke; do not ignite any open flames, and do not operate electric switches (light switches etc.).
- ▶ Before using the cooker make sure that there is sufficient ventilation. Open windows or the skylight.



- ▶ Do not use the gas cooker or gas oven for heating purposes.
- ▶ If there are several gas devices, each gas device must have its own gas isolator tap. If individual gas devices are not in use, close the respective gas isolator tap.
- ▶ Ignition safety valves must close within 1 minute after the gas flame has extinguished. A clicking sound is audible. Check function from time to time.
- ▶ The built-in gas devices are exclusively meant for use with propane or butane gas or a mixture of both. The gas pressure regulator as well as all built-in gas devices are designed for a gas pressure of 30 mbar.
- ▶ Propane gas is capable of gasification up to -42 °C, whereas butane gas gasifies at 0 °C. Below these temperatures no gas pressure is available. Butane gas is unsuitable for use in winter.
- ▶ Regularly inspect the gas tube fitted to the gas bottle connection for tightness. The gas tube must not have any tears and must not be porous. Have the gas tube replaced by an authorised specialist workshop no later than ten years after the manufacturing date. The operator of the gas system must see to it that the parts are replaced.
- ▶ Due to its function and construction, the gas bottle compartment is a space which is open to the exterior. Never cover or block up the standard forced ventilations. Otherwise gas that is emitted can not be diverted to the outside.
- ▶ Do not use the gas bottle compartment as storage space as it is not moisture-proof.
- ▶ Secure the gas bottle compartment against unauthorised access. To do this, lock the compartment.
- ▶ The regulator tap on the gas bottle must be accessible.
- ▶ Only connect gas-operated devices (e.g. gas grill) which have been designed for a gas pressure of 30 mbar.
- ▶ The exhaust gas pipe must be fitted tightly to the heating system and to the vent and must be sealed. The exhaust gas pipe must not show any evidence of damage.
- ▶ Exhaust fumes must be able to escape into the atmosphere unhindered and fresh air must be able to enter unhindered. For this reason, keep the exhaust pipe and intake openings clean and unobstructed (e.g. free from snow and ice). For this reason, no snow walls or aprons may lie against the vehicle.

2.5.2 Gas bottles



- ▶ Gas bottles are only to be transported within the designated gas bottle compartment.
- ▶ Place the gas bottles in vertical position in the gas bottle compartment.
- ▶ Fasten the gas bottles so that they are unable to turn or tilt.
- ▶ If the gas bottles are not connected to the gas tube, always place the protective cap on top.
- ▶ Close the regulator tap on the gas bottle before the gas pressure regulator or gas tube are removed from the gas bottle.
- ▶ Use your hands only to connect the gas pressure regulator or the gas tube to the gas bottles. Do not use any tools.



- ▶ Only use special gas pressure regulators with a safety valve designed for vehicle use. Other gas pressure regulators are not permitted and cannot meet the demanding requirements.
- ▶ Use the gas pressure regulator defroster if the temperature falls below 5 °C.
- ▶ Use only 11 kg or 5 kg gas bottles. Camping gas bottles with built-in check valve (blue bottle with max. 2.5 or 3 kg content) are can be used in exceptional cases with a safety valve.
- ▶ Use the shortest possible tube lengths (150 cm max.) for external gas bottles.
- ▶ Never block the floor ventilation openings below the gas bottles.

2.6 Electrical system



- ▶ Only allow qualified personnel to work on the electrical system.
- ▶ Prior to carrying out work on the electrical system, switch off all devices and lights, disconnect the battery and disconnect the vehicle from the mains.
- ▶ Only use original fuses with the stipulated values.
- ▶ Only replace defective fuses when the cause of the defect is known and has been remedied.
- ▶ Never bridge or repair fuses.

2.7 Water system



- ▶ Water left standing in the water tank or in the water pipes becomes undrinkable after a short period. Therefore, before each use of the vehicle, thoroughly clean the water pipes and the water tank. After each use of the vehicle completely empty the water tank and the water pipes.
- ▶ In the case of lay-ups lasting more than a week disinfect the water system before using the vehicle.



- ▷ If the vehicle is not used for several days or if it is not heated when there is a risk of frost, empty the entire water system. Make certain that the water pump is switched off on the panel. Otherwise, the water pump will overheat and may get damaged. Leave the water taps on in central position. Leave the safety/drainage valve (if there is one) and all drain cocks open. Frost damage to appliances, frost damage to the vehicle and deposits in water-carrying components can be avoided in this way.

Chapter overview

This chapter contains important information which has to be noted before commencing your journey or carrying out any tasks before the journey.

The instructions address the following topics:

- keys
- registration
- calculating the payload
- correct loading of the vehicle and bike rack
- load rack
- towing
- retracting and extending the entrance step
- storing the television
- storing the sink cover
- securing add-on parts
- using snow chains

At the end of the chapter there is a checklist which once again summarises the most important points.

3.1 Keys

The following keys are included with your vehicle:

Two keys for

- ignition lock
- driver's and passenger's doors
- fuel tank

Two keys for

- conversion door of the body
- drinking water filler neck
- external flaps

Always deposit a replacement key outside the vehicle. Make a note of the key number. Our authorised dealers and workshops can offer assistance in case of loss.

3.2 Registration

Your motorhome is a vehicle which must be registered. Observe national regulations on registration.

Please remember that certain countries require a separate national code sticker in addition to the EU plate.

3.3 Payload



- ▶ Overloading the vehicle and wrong tyre pressure can cause tyres to burst. You can lose control of the vehicle.
- ▶ Only the maximum permissible gross weight and the mass in a ready-to-drive condition, not the actual weight of the vehicle, is stated in the vehicle documents. For your own safety, we recommend that you have your loaded vehicle (with all passengers, luggage and personal objects) weighed on a public weighbridge before you set out on your journey.
- ▶ Adapt the speed to the payload. The stopping distance is increased if the payload is high.



- ▷ Do not exceed the maximum permissible gross weight stated in the vehicle documents by the payload.
- ▷ Built-in accessories and special equipment reduce the payload.
- ▷ Adhere to the axle load stated in the vehicle documents.

On loading, make sure that the payload's centre of gravity is as low as possible (directly above the floor of the vehicle). Otherwise this may affect the driving characteristics of the vehicle.

Maximum permitted payloads

Description	Load (kg)
Pull-down bed	200
Bunk bed	100
Roof load	200
Rear garage and rear storage space	200
Bike rack Double	60
Bike rack Triple	60
Load rack (AL-KO)	150
Load rack (SAWIKO)	130

3.3.1 Terms



- ▷ Technically speaking, the term "mass" has now replaced the term "weight". However, "weight" is still the term more frequent in common use. For better understanding, "mass" is therefore only used in the following sections for fixed formulations.
- ▷ All specifications according to EU norm DIN EN 1646-2.

Maximum permissible gross weight in a laden condition

The maximum permissible gross weight in a laden condition is the weight that a vehicle may never exceed.

The maximum permissible overall weight in laden condition consists of the **mass in ready-to-drive condition** and of the **payload**.

In the vehicle documents, the manufacturer has specified the maximum permissible gross weight in a laden condition.

Permitted mass

The permitted mass is the weight specified by the manufacturer for issuing the type approval. The permitted mass must never exceed the maximum permissible gross weight of the loaded vehicle.

Mass in ready-to-drive condition

The mass in ready-to-drive condition is the weight of the ready-to-drive standard vehicle.

The mass in ready-to-drive condition is made up as follows:

- Unladen weight (mass of the empty vehicle) with factory-installed standard equipment
- Driver's weight
- Basic equipment weight

Unladen weight includes lubricants such as oils and coolants which have been filled, the on-board tool set, the spare wheel and a fuel tank which has been filled up to 90 %.

75 kg are calculated for the weight of the driver, regardless of how much the driver really weighs.

Basic equipment includes all equipment and fluids required for safe and proper vehicle use. The weight of the basic equipment includes:

- Water system filled up to 90 % (water tank and pipes)
- Gas bottles filled up to 90 %
- A full heating system
- The power cables for the 230 V power supply
- A full toilet flushing system
- The installation kit for an auxiliary battery if an auxiliary battery can be used

The waste water and sewage tanks are empty.

Example for calculating the basic equipment

Water tank with 120 l	120 kg
Gas bottles (2 x 11 kg _{gas} + 2 x 14 kg _{bottle})	+ 50 kg
Boiler with 12 l	+ 12 kg
230 V power cable	+ 4 kg
Installation kit for auxiliary battery	+ 20 kg
Total	= 206 kg

In the vehicle documents, the manufacturer specifies the mass in ready-to-drive conditions.

Payload

The payload is made up as follows:

- Conventional load
- Additional equipment
- Personal equipment



- ▷ The vehicle's payload can be increased by reducing the weight in a ready-to-drive condition. To do this, it is allowed for example to empty the fluid containers or to remove the gas bottles.

You will find explanations on the individual components of the payload in the following text.

Conventional load

The conventional load is the weight specified by the manufacturer for the passengers.

Conventional load means: 75 kg are calculated for every seat specified by the manufacturer, regardless of how much the passengers actually weigh. The driver's seat is already included as part of the mass in ready-to-drive condition and must **not** be calculated as part of the conventional load.

In the vehicle documents, the manufacturer specifies the number of seats.

Additional equipment Additional equipment includes accessories and special equipment. Examples of additional equipment include:

- Caravan coupling
- Roof rail
- Awning
- Bike or motorcycle rack
- Satellite unit
- Microwave oven

Chapter 15 lists the weights of the various items of special equipment; they may also be obtained from the manufacturer.

Personal equipment Personal equipment includes all items in the vehicle that are not included in the conventional load or in the additional equipment. For example, personal equipment can include the following:

- Foodstuffs
- Crockery
- Television
- Radio
- Clothes
- Bedding
- Toys
- Books
- Toiletries

No matter where kept, personal equipment also includes:

- Animals
- Bikes
- Boats
- Surfboards
- Sports equipment

For the personal equipment, according to the applicable regulations, the manufacturer must use a minimum weight that is determined according to the following formula:

Formula Minimum weight M (kg) = $10 \times N + 10 \times L$

Explanation N = maximum number of people including the driver, as stated by the manufacturer
 L = total length of the vehicle in metres

3.3.2 Calculating the payload



- ▶ The payload calculation at the factory is partly based on all-inclusive weights. For safety reasons, the maximum permissible gross weight in a laden condition must not be exceeded.
- ▶ Only the maximum permissible gross weight and the mass in a ready-to-drive condition, not the actual weight of the vehicle, is stated in the vehicle documents. For your own safety, we recommend that you have your loaded vehicle (with all passengers, luggage and personal objects) weighed on a public weighbridge before you set out on your journey.

The payload (see section 3.3.1) is the difference in weight between

- Maximum permissible gross weight in a laden condition and
- Vehicle mass complete in a ready-to-drive condition.

Example for calculating the payload

	Mass in kg to be calculated	Calculation
Maximum permissible gross weight according to vehicle documents	3500	
Vehicle mass in a ready-to-drive condition, including basic equipment according to vehicle documents	- 3070	
This results in a permissible payload of	430	
Conventional load e.g.: 3 persons each weighing 75 kg	- 225	
Additional equipment	- 40	
For the personal equipment this results in	= 165	

The calculation of the payload from the difference between the maximum permissible gross weight in laden condition and the mass specified by the manufacturer in ready-to-drive condition is however only a theoretical value.

Only if the vehicle is weighed with full tanks (fuel and water), full gas bottles and complete additional equipment on a public weighbridge, can the actual payload be determined.

To do this, proceed as follows:

- First only drive the vehicle on to the weighbridge with the front wheels and have it weighed.
- Then drive the vehicle on to the weighbridge with the back wheels and have it weighed.

The individual values give the current axle loads. These are important for the correct loading of the vehicle (see section 3.3.3). The sum of these values is the current weight of the vehicle.

The actual payload is the difference between the maximum permissible gross weight in laden condition and the weighed vehicle weight.

This can be used to determine the weight that remains for the personal equipment:

- Determine the weight of the passengers and subtract it from the value for the actual payload.

The result is the weight that is permitted for the actual load of the personal equipment.

3.3.3 Loading the vehicle correctly



- ▶ For safety reasons, never exceed the maximum permissible gross weight in a laden condition.
- ▶ Distribute the load evenly on the left and right sides of the vehicle.



- ▶ Distribute the load evenly on both axles. In doing so, observe the axle loads specified in the vehicle documents. Observe the permissible load-carrying capacity of the tyres (see chapter 13).
- ▶ Heavy loads behind the rear axle can reduce the load on the front axle due to the leverage effect (). This applies especially to long rear extensions, if a motorbike is transported on the rear carrier or if there is a heavy load in the rear storage space. The release of the front axle negatively affects the driving quality, especially for front-driven vehicles.
- ▶ Store all objects in such a way that they cannot slip.
- ▶ Store heavy objects (awning, tin cans, etc.) close to the axles. Low-lying storage compartments whose doors do not open in the direction of travel are particularly suited for storing heavy objects.
- ▶ Stack light objects (laundry) in the roof storage cabinets.
- ▶ Load the bike rack with bicycles only (max. three units).

Large storage spaces, such as the rear garage, also have room for heavy objects (e.g. motorcycle). This might mean that the axle load on the rear axle is exceeded.

However, the individual axles may not be overloaded under any circumstances. That is why it is important, at which distance to the axles the load is stored.

To distribute the load correctly, you will need a scale, a tape measure, a calculator and some time.

Two simple formulas are needed to calculate the effect of the weight of the load on the axles:

Formulas

$A \times G : R =$ weight on the rear axle

Weight on the rear axle – $G =$ weight on the front axle

Explanation

A = distance between storage compartment and front axle in cm

G = weight of the load in the storage compartment in kg

R = wheelbase of the vehicle (distance between axles) in cm



- ▷ Measure the external distances horizontally from the centre of the front wheel to the centre of the storage compartment or to the centre of the back wheel.

Calculating axle loads:

- Multiply the distance between storage compartment and front axle (A) with the weight of the load in the storage compartment (G) and divide the result by the wheelbase (R). The result is the weight of the load in the storage compartment on the rear axle. Make a note of this weight and of the storage compartment.
- In a second step, subtract the weight in the storage compartment (G) from the weight calculated beforehand. If the result is a **positive** value (example 1), this means that the load on the front axle is **reduced** by this value. If the result is a **negative** value (example 2), this means that the load on the front axle is **increased**. Make a note of this value, too.
- Calculate all storage compartments of the vehicle in the same way.
- In a last step, add all weights calculated for the rear axle to the rear axle load and add (or subtract) all weights calculated for the front axle to (from) the front axle load.

How to determine rear axle load and front axle load is described in section 3.3.2.

If the calculated value exceeds the permissible axle load, the load must be distributed in a different way.

If the load on the front axle is too low, the grip of the tyres on the road is reduced (traction). This applies in particular to vehicles with front wheel drive. In this case, the load must be redistributed, too.

Example calculation

		Example 1	Example 2
Distance to the front axle	A	(A1) 450 (cm)	(A2) 250 (cm)
Weight in the storage compartment	G	x 100 (kg)	x 50 (kg)
Wheelbase of the vehicle	R	÷ 325 (cm)	÷ 325 (cm)
Load on the rear axle (add to the axle load)		138.5 (kg)	38.5 (kg)
Weight in the storage compartment		- 100 (kg)	- 50 (kg)
Load relief to the front axle (subtract from the axle load)		38.5 (kg)	
Load on the front axle (add to the axle load)			-11.5 (kg)

3.3.4 Roof rail and ladder (partially special equipment)



- ▶ Access the roof only when a roof rail has been fitted. Only climb onto the roof via a ladder.
- ▶ Take care when stepping onto the ladder. There is danger of slipping when the ladder is moist or icy.
- ▶ Take care when stepping onto the roof. There is danger of slipping when the roof is moist or icy.
- ▶ Do not overload the roof. Road behaviour and brake reaction deteriorate as the roof load increases.



- ▷ If the vehicle is equipped with a roof rail, load racks can be mounted on the roof rail for roof loads (e.g. for surfboards, rubber boats or light canoes). Special girder systems are available as accessory. The authorised dealer or service centre will be happy to advise you.
- ▷ The maximum permissible roof load is 200 kg.
- ▷ The maximum localised load is 90 kg/100 cm².
- ▷ Before stepping on to the roof, extensively cover the area you will be treading on. Materials with a smooth or soft surface are suitable, for example, a thick polystyrene panel.
- ▷ Secure roof loads with tension belts. Do not use rubber expanders.
- ▷ Observe the overall height of the vehicle when the roof rack is loaded.



- ▷ The driver's cabin should have a clearly visible notice stating the overall height. This eliminates the need for calculations at bridges and thoroughfares.

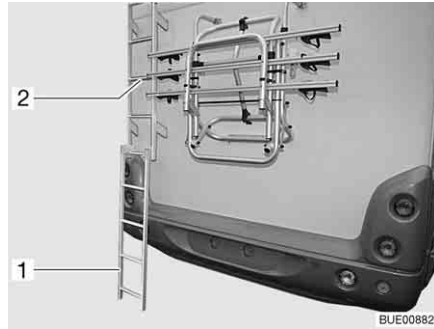

Fig. 1 Rear ladder

*Climbing on to the roof
(hook-in ladder):*

- Hook the lower part of the ladder (Fig. 1,1) in the part of the ladder (Fig. 1,2) which is fastened to the rear, and place it on the ground.
- Carefully climb the ladder.

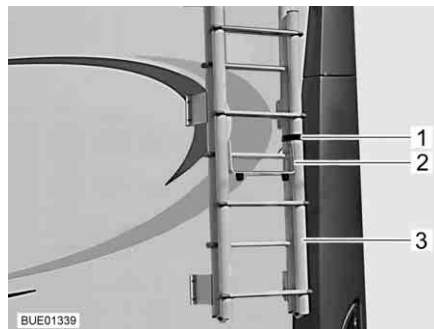

Fig. 2 Foldable ladder, ladder folded upwards

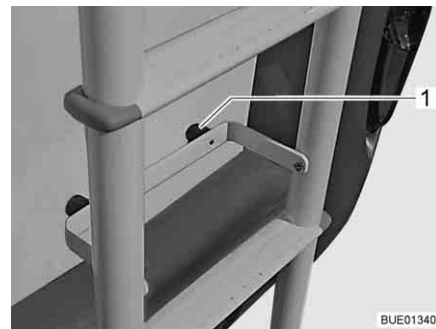

Fig. 3 Foldable ladder, ladder folded downwards

*Climbing on to the roof
(foldable ladder):*

- Open the strap (Fig. 2,1) on the ladder (Fig. 2,3) at the rear of the vehicle.
- Fold out the guard rail (Fig. 2,2).
- Extend the ladder downward.
- Place guard rail with the rubber knobs (Fig. 3,1) up against the back panel of the vehicle.
- Carefully climb the ladder.

*Climbing on to the roof
(telescopic ladder):*

- Carefully place the telescopic ladder (special equipment) against the side of the vehicle.
- Carefully climb the ladder.

3.3.5 Rear garage/rear storage space



- ▶ Observe the permissible axle loads and maximum permissible gross weight when loading the rear garage/the rear storage space.
- ▶ The maximum permitted load of the rear garage/the rear storage space is 200 kg. Do not exceed the permissible rear axle load.
- ▶ Observe: If the rear garage or (depending on the model) the rear storage space is **loaded** to its maximum capacity, this will **reduce the load** on the front axle due to the levering action. The driving quality is impaired.



- ▷ Depending on the vehicle equipment, clamping rails with clamping eyelets are mounted in the rear garage or in the rear storage space. Always secure loads onto the clamping eyelets. Always use tightening straps or lashing nets for securing the load, never rubber expanders.
- ▷ When clamping loads, always check that the clamping eyelets are placed tightly in the clamping rails. If the clamping eyelet is not anchored tightly in the clamping rail, the load may slide or loosen during forcible movements of the steering wheel or when braking.
- ▷ Distribute the load evenly. Excessive spot loads can lead to damages of the floor covering.
- ▷ Use the supporting system offered by your dealer if two-wheelers are transported in the rear garage.

3.3.6 Bike rack (special equipment)



- ▶ Observe the permissible axle loads and maximum permissible gross weight when loading the bike rack.
- ▶ Bicycles may protrude at the side by a maximum of 40 cm, measured from the outer edge of the tail lights. However, a total width of 2.5 m must not be exceeded. Adjust the attachments for the bikes accordingly. The lateral overhang must be marked with a red flag.
- ▶ Load the bike rack with bicycles only (max. three units).
- ▶ Fasten bicycles using the straps provided and check to see that they are secure after you have driven a few kilometres.
- ▶ Check the secure attachment of the bicycles on the bike rack after the first 10 km and then at each break in the journey.
- ▶ Do not use the bike rack as luggage rack or ladder.



- ▷ The bike rack is only to be used for transporting bicycles.
- ▷ The gross weight specified by the manufacturer must not be exceeded.
- ▷ The identification plate and rear lights must not be covered.
- ▷ The maximum permissible payload of the bike rack is 60 kg.
- ▷ When loading the bike rack, observe the centre of gravity. If the bike rack is only loaded with **one** bicycle, position the bicycle as closely as possible to the vehicle wall.
- ▷ Driving with a folded out bike rack without bicycles is not permitted.
- ▷ Before every journey, check:
 - Is the bike rack without bicycles folded in correctly?
 - Are the bicycles securely fastened to the bike rack using the bike rack belts?

Loading the bike rack with bicycles

When loading the bike rack, observe the centre of gravity. The centre of gravity of the bicycles must be as close as possible to the rear wall of the vehicle. The bike rack should always be loaded from the inside to the outside.

Loading the bike rack correctly:

- Depending on the model, fold the bike rack down or pull it out.
- Place the heaviest bicycle directly against the rear wall.
- Place the lightest bicycles in the centre or on the outside of the bike rack.

- Secure the front and rear wheels of each bicycle with the retaining straps on the bike rack.
- In addition, fasten the outermost bicycle depending on the model of the bike rack on the retaining clip or the retaining bracket and to the spacer respectively.

If the bike rack is only loaded with **one** bicycle, position the bicycle as closely as possible to the rear wall.

Bike rack, lowerable



- ▷ Also read the manufacturer's instruction manual.

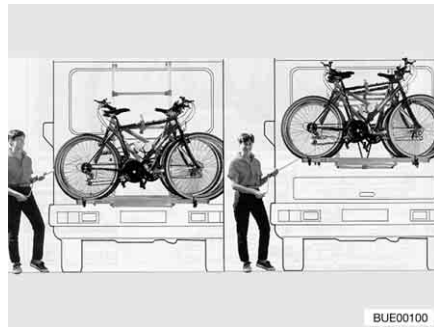

Fig. 4 Bike rack, lowerable

The bike rack (Fig. 4) permits to easily transport 2 bicycles. Expansion for 3 bicycles is possible. A winding system may be used to lift and lower the bike rack approx. 40 cm. The winding system brings the bicycles to gripping height within seconds.

Loading the bicycles:

- Attach the manual crank to the bicycle rack and lower the bike rack to gripping height.
- Place the bicycles on top and secure them with quick straps.
- Fasten the bike-block spacer to the frame of the outermost bicycle.
- Use the manual crank to lift the bicycles back up.

Bike rack, not lowerable



- ▷ Also read the manufacturer's instruction manual.

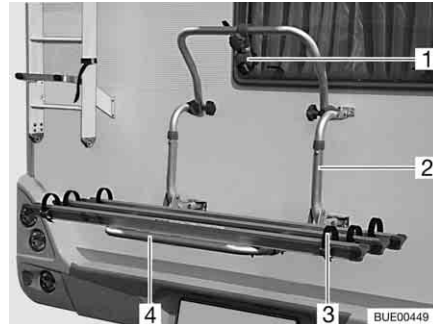

Fig. 5 Bike rack, not lowerable

The bike rack (Fig. 5,2) permits to easily transport 2 bicycles. Expansion for 3 bicycles is possible.

Loading the bicycles:

- Fold the telescopic swivel clip (Fig. 5,4) down.
- Place the bicycles on top and secure them with quick straps (Fig. 5,3).
- Fasten the spacer (Fig. 5,1) to the frame of the outermost bicycle.

3.3.7 Removable load rack AL-KO (special equipment)



- ▶ Do not exceed the rear axle load.
- ▶ Heavy loads behind the rear axle can reduce the load on the front axle due to the leverage effect ($\frac{L}{L_0} \cdot \frac{L_0}{L_0}$). This applies especially to long rear extensions, if a motorbike is transported on the rear carrier or if there is a heavy load in the rear storage space. The release of the front axle negatively affects the driving quality, especially for front-driven vehicles.
- ▶ Always make sure to store the load roadworthy and secure it against falling.
- ▶ The load may not jut out beyond the maximum width of the vehicle. The lighting and the official licence plate on the load rack may not be covered by the load.



- ▷ The load rack and caravan coupling may not be used simultaneously.



- ▷ The load rack has a EG type approval number.
- ▷ Have your dealer or service centre install the load rack.
- ▷ Observe the country-specific regulations.
- ▷ Also read the manufacturer's instruction manual.

The load rack permits transport of a load (e.g. a motorcycle or a motor scooter) weighing up to 150 kg. Always remove the load rack after use.

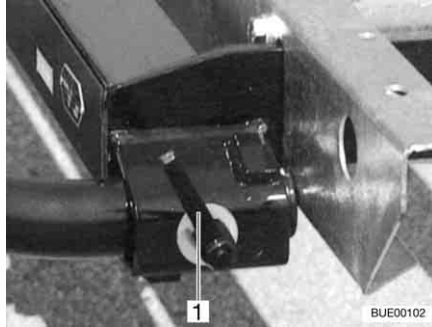

Fig. 6 Quick closure

- Installation:**
- Apply the handbrake.
 - Insert the supports on the left and on the right into the holders on the frame and secure them with a quick closure (Fig. 6,1).
 - Connect the electrics between the load rack and the vehicle.
- Removal:**
- Apply the handbrake.
 - Disconnect the electrics between the load rack and the vehicle.
 - Open the quick closure (Fig. 6,1) and pull the support from the holders on the frame.

3.3.8 Load rack SAWIKO (special equipment)



- ▶ Do not exceed the rear axle load.
- ▶ Heavy loads behind the rear axle can reduce the load on the front axle due to the leverage effect ($\frac{L}{L_0} \cdot \frac{L_0}{L}$). This applies especially to long rear extensions, if a motorbike is transported on the rear carrier or if there is a heavy load in the rear storage space. The release of the front axle negatively affects the driving quality, especially for front-driven vehicles.
- ▶ Always make sure to store the load roadworthy and secure it against falling.
- ▶ The load may not jut out beyond the maximum width of the vehicle. The lighting and the official licence plate on the load rack may not be covered by the load.



- ▷ The load rack and caravan coupling may not be used simultaneously.



- ▷ An entry must be made in the vehicle documents in order to attach a load rack. The required documents are enclosed with the load rack.
- ▷ Have your dealer or service centre install the load rack.
- ▷ Observe the country-specific regulations.
- ▷ Also read the manufacturer's instruction manual.

The load rack permits transport of a load weighing up to 130 kg. For the transport of the load different attachments are available. They are e.g. bike rack or a transport box. Our authorised dealers and service centres will be happy to advise you.

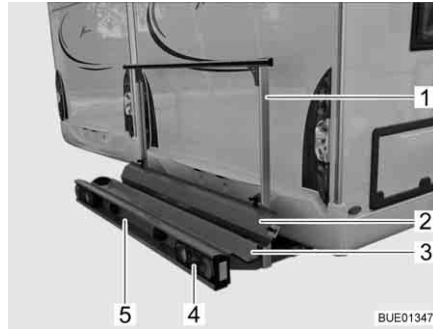

Fig. 7 Load rack

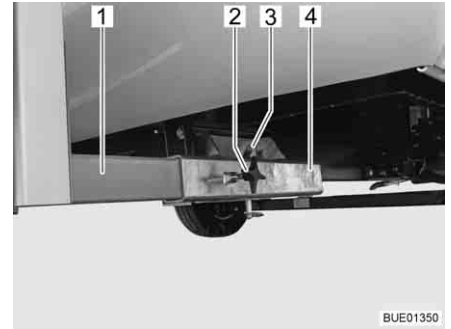

Fig. 8 Attachment to vehicle

The load rack (Fig. 7) permits transport of a motorcycle or a motor scooter weighing up to 130 kg.

Scope of delivery

The following parts belong to the scope of delivery:

- Rack trough (Fig. 7,3) and retaining clip (Fig. 7,1) with attachment to vehicle (Fig. 8)
- Rear lights (Fig. 7,4)
- Vehicle licence plate light (Fig. 7,5)
- 13-pole Jäger System plug
- Ramp (Fig. 7,2)

Attachment to vehicle

The two side members (Fig. 8,1) of the load rack are fixed to the floor of the vehicle by means of tommy screws (Fig. 8,2) on the square drives (Fig. 8,4). The load rack is secured by a bolt (Fig. 8,3) with locking ring.

Entry in the vehicle documents

Have your dealer or service centre install the add-on parts. They will also take care of all the formalities for you.

3.4 Towing



- ▶ Care is to be taken when connecting and detaching a trailer. Risk of accident and injury!
- ▶ No persons are to be between the towing vehicle and the trailer during positioning for connecting and detaching.
- ▶ Observe the permissible nose weight and rear axle load of the towing vehicle. Nose weight and rear axle load must not be exceeded. The values of the nose weight and rear axle load are included in the documents of the vehicle and the caravan coupling.



- ▷ Trailer with an overrun brake: Do not connect or detach trailer with the overrun brake on.
- ▷ Caravan coupling with detachable ball neck: If the ball neck is mounted incorrectly, there is the danger of the trailer breaking away. Observe the instruction manual for the caravan coupling.

3.5 Caravan coupling (special equipment)



- ▶ When mounting a caravan coupling, see the vehicle documents for information on maximum nose weight and caravan load.
- ▶ Retighten the caravan coupling fixing screws after 1000 operating hours.



- ▷ The load rack and caravan coupling may not be used simultaneously.



- ▷ An entry must be made in the vehicle documents in order to attach a caravan coupling. The required documents are enclosed with the caravan coupling.
- ▷ Also read the manufacturer's instruction manual.



Fig. 9 Caravan coupling

Entry in the vehicle documents

Have your dealer or service centre install the add-on parts. They will also take care of all the formalities for you.

3.6 Entrance step

3.6.1 Free-standing entrance step



- ▶ Make sure that the entrance step stands on secure and level ground. This will prevent the entrance step from toppling over.
- ▶ Do not step on the edges of the entrance step. Danger of slipping!
- ▶ Secure the entrance step to the ground, for example, with tent pegs. This way the entrance step cannot slip away.

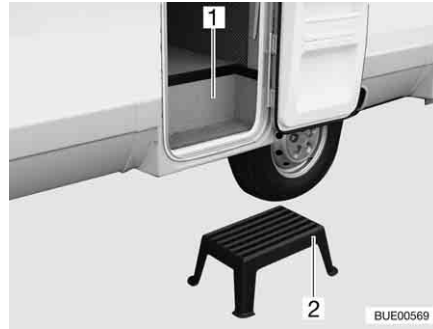

Fig. 10 Entrance step

A guide step (Fig. 10,1) is at the entrance to the vehicle.
Place the entrance step (Fig. 10,2) in front of the entrance to the vehicle.

3.6.2 Electrically operated entrance step (partially special equipment)



- ▶ Before commencing the journey and after short interruptions of the journey, ensure that the entrance step is completely retracted.
- ▶ Do not stand in the direct range of the entrance step while it is being retracted or extended.
- ▶ Do not step on the entrance step until it has extended completely. There is a risk of injury.
- ▶ Do not under any circumstances raise or lower persons or loads with the entrance step.



- ▷ Take note of the different step heights and make certain that the ground is firm and even when exiting.
- ▷ Do not grease or lubricate the pivot bearing and joints of the entrance step (see chapter 11).



- ▷ The button to operate the entrance step is located on the inside of the vehicle in the area of the conversion door.
- ▷ If the entrance step is not retracted and locked in place correctly, a red indicator lamp lights up on the dashboard when the ignition is switched on.
- ▷ Follow the warning notice on the entrance step.

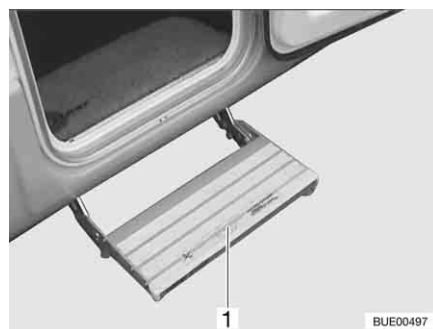

Fig. 11 Entrance step

The vehicles have a one-step, electrically extendable entrance step (Fig. 11,1).

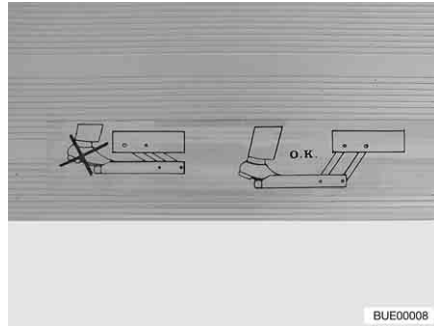

Fig. 12 Warning notice for entrance step

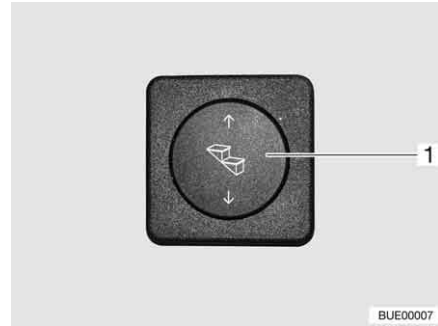

Fig. 13 Operating button for entrance step

Before stepping on the entrance step, fully extend it (Fig. 12).

- Extending:*
- Press the rocker button (Fig. 13,1) down and hold it pressed (at least 3 seconds) until the entrance step has extended completely.
- Retracting:*
- Press the rocker button (Fig. 13,1) up until the entrance step has retracted completely.

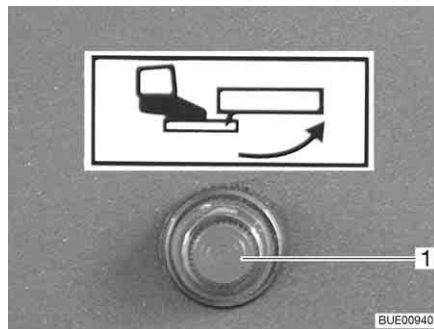

Fig. 14 Indicator lamp

When the ignition is switched on and the entrance step is extended, an indicator lamp (Fig. 14,1) is illuminated on the dashboard.

3.7 Television (special equipment)



- ▶ Before commencing the journey, remove the television from the support and store it securely.
- ▶ Before commencing the journey, place and secure the flat screen and screen support in the initial position. If the screen holder is installed in a TV cabinet: Close TV cabinet.
- ▶ Before commencing the journey, ensure that the antenna is in park position. Danger of accidents! Park position means: The antenna points towards the back, is fully lowered and is locked in this position.



- ▷ If there is a risk of frost, do not leave the flat screen television in the vehicle.



- ▷ Further information on positioning the flat screen can be obtained from chapter 6.

3.8 Sink and drain basin covers



- ▶ In the event of an accident or emergency braking, the loose sink (Fig. 15,1) and drain basin covers could injure the occupants of the vehicle. Before commencing the journey, take the loose covers off and store them securely in the kitchen unit or wardrobe.



Fig. 15 Sink cover

3.9 Securing add-on parts



- ▶ In the event of an accident or emergency braking, loose add-on parts could injure the occupants of the vehicle. Before setting off, secure loose add-on parts in the holders provided or stow them in a secure place inside the vehicle.



- ▷ Unsecured flaps and doors can spring open during the journey and damage parts of the interior. Secure all flaps and doors before setting off.

Add-on parts

Add-on parts include bed extensions, ladders or table extensions.



Fig. 16 Bed extension in the rear garage



Fig. 17 Access ladder in the wardrobe

Securing add-on parts:

- Place the add-on parts (Fig. 16,1 and Fig. 17,1) in the holders provided and secure them with the available means of attachment.
- If no holder is provided for the add-on part, stow the add-on part in a storage space the doors of which cannot be opened in the direction of travel (e.g. wardrobe or rear storage space).

Doors and flaps

Doors are, for example, inner doors or partition walls. See section 6.3 for furniture flaps.



Fig. 18 Shower partition

Securing doors: ■ Secure doors or partition walls (Fig. 18,1) with the locks or means of securing provided.

3.10 Snow chains (special equipment)



- ▷ Only mount snow chains if there is a clearance of at least 50 mm between the tyres and the vehicle body.
- ▷ When using snow chains, the tyres, wheel suspension and steering are subjected to an additional load. When using snow chains, drive slowly (maximum speed 50 km/h) and only on streets which are completely covered with snow. Otherwise the vehicle could be damaged.
- ▷ Observe the fitting instructions issued by the manufacturer of the snow chains.
- ▷ Do not fit snow chains on alloy wheel rims.



- ▷ If the drive axle of the vehicle has twin tyres (2 tyres next to each other), mount the the snow chains to the outer tyres.

The use of snow chains is subject to the legal regulations of the individual countries.

- Always mount snow chains to the drive wheels.
- After a few metres, check the tension of the snow chains.

3.11 Road safety



- ▶ Check tyre pressure before a journey or every 2 weeks. Wrong tyre pressure causes excessive wear and can lead to damage or even to tyre burst. You can lose control of the vehicle.

Before commencing the journey, work through the checklist:

Base vehicle

No.	Checks	Checked
1	All vehicle documents are on board	
2	Tyres in proper condition	
3	Vehicle lighting, brake lights and reversing lights function	
4	Oil levels for engine, gearbox and power steering controlled	
5	Coolant and fluid for windscreen washers filled up	
6	Brakes function	

No.	Checks	Checked
7	Brakes react evenly	
8	When braking, the vehicle remains in the lane	

Housing body, outside

9	Awning completely retracted	
10	Roof free of snow and ice (in winter)	
11	External connections and lines disconnected and stored away	
12	External supports removed	
13	Fitted supports retracted and fixed in place	
14	Wheel chocks removed and stored away	
15	Entrance step is stored securely or retracted	
16	External flaps closed and locked	
17	Conversion door locked	
18	Overall height of the vehicle including roof rack when loaded measured and noted. Keep the height information close at hand in the driver's cabin	

Housing body, inside

19	Windows and skylights closed and locked	
20	Television securely stored	
21	Flat screen secured	
22	Television antenna retracted (if one is built in)	
23	Loose parts and add-on parts stored away or fixed in position	
24	Open storage spaces empty	
25	No gas cartridges or other easily flammable materials stored in the roof cupboard of the awning light	
26	Store sink and drain basin covers securely	
27	Refrigerator door secured	
28	Refrigerator set to 12 V operation	
29	All drawers and flaps closed	
30	All doors secured	
31	Pull-down bed secured	
32	Children's seats mounted to seats with three-point safety belts	
33	Swivel seat locking device for driver's seat and front passenger's seat locked	
34	Shades in the driver's cabin opened and secured	

Gas system

No.	Checks	Checked
35	Gas bottles firmly fixed in the gas bottle compartment so that they are unable to turn	
36	If the gas bottles are not connected to the gas tube, always place the protective cap on top	
37	Regulator tap on the gas bottle and gas isolator taps are closed	

Electrical system

38	<p>Check the battery voltage of the starter and living area battery (see chapter 8). If the panel indicates that the battery voltage is too low, the respective battery will need to be recharged. Observe the notes and instructions in chapter 8</p> <p> ▷ Commence journey with fully charged starter and living area batteries.</p>	
----	--	--

Chapter overview

This chapter contains instructions on how to drive the motorhome.

The instructions address the following topics:

- the parking distance control
- reversing camera with LCD monitor
- driving speed
- brakes
- seat belts
- child restraint system
- seats and headrests
- seating arrangement
- Roman shades in the driver's cabin
- filling the tank

4.1 Driving the motorhome



- ▶ The base vehicle is a commercial vehicle (small truck). Adjust your driving technique accordingly.
- ▶ Before commencing the journey and after short interruptions of the journey, ensure that the entrance step is completely retracted.
- ▶ During the journey, seat belts should always be worn at the seats that have seat belts mounted.
- ▶ Never open your seat belts when travelling.
- ▶ Passengers must remain in the seats provided.
- ▶ The doors must remain locked.
- ▶ Avoid braking with a jerk.
- ▶ If a navigation system is used, only change the destination when the vehicle is stationary. Drive to a car park or stop in a safe area when changing the destination.
- ▶ Do not play DVDs using the monitor of the navigation system during the journey.



- ▷ Drive slowly on poor roads.
- ▷ Take extreme care when driving onto ferries, crossing uneven roads and driving in reverse. Because of the relatively large overhang, larger vehicles might swing out and "touch ground" in unfavourable conditions. This can cause damage to the underbody or to parts fitted there.



- ▷ If an accident occurs as a result of these instructions not being observed, the manufacturer will not be responsible for damages caused.
- ▷ The safety measures stipulated in chapter 2 have to be observed.
- ▷ If a reversing camera is installed in the vehicle, the camera is automatically switched on when driving in reverse gear.

4.2 Parking distance control Park Boy V (special equipment)



- ▶ Be particularly careful when driving backwards. Risk of accident and injury.
- ▶ The parking distance control is only an auxiliary appliance and may not necessarily recognise all obstacles. The driver of the vehicle is responsible for safety. If the device fails or there is a malfunction and damage occurs, then claims cannot be asserted against the vehicle manufacturer.
- ▶ Soil deposits, ice, snow and exhaust fumes can prevent the parking distance control from working properly.
- ▶ Only if you drive slowly (at inching speed) will a warning be emitted in time.
- ▶ Obstacles above or below the sensor measurement area will be ignored (e.g. projecting load ramps).
- ▶ Precipitous embankments or road edges (e.g. quay walls) are ignored.



- ▷ Reflections from the road (a change of surface, irregularities) can sometimes trigger false alarms. This is not due to an error in the parking distance control.

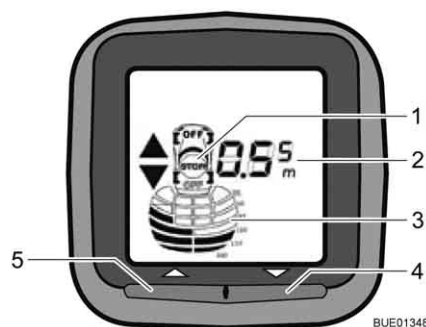

- 1 STOP symbol
- 2 Distance display in cm (in 5 cm intervals)
- 3 Distance to the obstacle (graphical display)
- 4 On/Off button for the sensors at the rear of the vehicle
- 5 Without function

Fig. 19 Park Boy V display unit

Short description

The parking distance control serves as an aid for parking. The distance to possible obstacles is measured using the ultrasound echo sounder method. Four sensors at the rear of vehicle send ultrasound signals and the distance to the obstacle is measured according to the time taken by the reflected ultrasound signals.

In the passenger compartment, a display unit (Fig. 19) shows the distance to the obstacle. At the same time, an acute signal sounds as a warning.

The sensors and display unit are linked by radio.



- ▷ When you switch on the ignition, the parking distance control runs a self-test. If a sensor is defective, this is indicated on the display by rapid flashing of the sensor position. The parking distance control continues to function, with the exception of the defective sensor.

If the radio connection is faulty, this will be indicated on the display by means of a transmission mast symbol. Distance measurement is then not possible.

When reverse gear is disengaged, the transmission mast symbol is also briefly displayed.

Activation by engaging reverse:

- Switch on the ignition and start the motor.
- Engage reverse. The display illuminates and the vehicle symbol appears in the display. The parking distance control is ready to measure.

Activation by pressing the On/Off button on the display unit:

- Press the On/Off button (Fig. 19,4). The display illuminates and the vehicle symbol appears in the display. The parking distance control is ready to measure.

Switching off:

- Press the On/Off button (Fig. 19,4). The parking distance control can be switched off at all times independent of the selected switch-on method using the On/Off key.

Distance display

The distance between the vehicle and the obstacle is issued in three ways: The display (Fig. 19) shows the distance in steps of 5 cm. The shortest distance measured by a sensor is shown.

Black measurement field blocks in the graphical distance display show an obstacle approaching.

In addition to the visual displays, an acoustic signal (melody) is emitted that changes according to the distance. As the distance between the vehicle and the obstacle grows shorter, so the length of time between the signals shortens until it becomes one continuous sound.



- ▷ Further information can be obtained in the device manufacturer's instruction manual.

4.3 Reversing camera (special equipment)



- ▷ Depending on the model, different monitor systems can be installed in the vehicle. The function of the reversing camera is the same way for all systems.



Fig. 20 Reversing camera (example)



Fig. 21 Reversing camera with infrared illumination

Depending on the equipment, a reversing camera (Fig. 20,1 or Fig. 21,1) with LCD monitor (Fig. 22,1) is installed in the vehicle.



Fig. 22 LCD monitor for reversing camera (example)

When it is dark, the infrared LEDs of the reversing camera (Fig. 21,1) illuminate the field of view.

If the engine is running or the ignition is switched on, the reversing camera and LCD monitor switch themselves on automatically when you engage reverse.

If the engine is running or the ignition is switched on, the reversing camera and LCD monitor can also be switched on manually via a pushbutton or a switch on the display.

The system can also be switched off via a pushbutton or the "OFF" button on the display.



- ▷ Further information can be obtained in the manufacturer's instruction manual.

4.4 Driving speed



- ▶ The vehicle is equipped with a powerful engine. This means there are sufficient reserves in difficult traffic situations. This high power enables a high maximum speed and requires above-average driving ability.
- ▶ The vehicle provides a large contact surface for wind. A sudden crosswind can be especially dangerous.
- ▶ Uneven or one-sided loading affects road performance.
- ▶ Driving on unknown streets, you may encounter hazardous road conditions and unexpected driving situations. Therefore, in the interest of safety, make sure your driving speed is appropriate to any given driving situation and environment.
- ▶ Adhere to the national legal speed limits.

4.5 Brakes



- ▶ Have defects on the braking system immediately remedied by an authorised specialist workshop.



- ▷ Avoid block brakings. Block braking gives the tyres "brake plates" of varying strength. This reduces driving comfort. It might even make the tyres unserviceable.

Before each journey Before each journey, check by means of a braking test:

- Do the brakes function?
- Do the brakes react evenly?
- Does the vehicle remain in the lane when braking?

4.6 Seat belts

The vehicle is equipped with seat belts in the living area on the seats for which seat belts are compulsory by law. National regulations apply seat-belt fastening.



- ▶ Fasten your seat belts before the beginning of the journey and keep them fastened during the journey.
- ▶ Do not damage or trap belts. Have damaged seat belts changed by an authorised specialist workshop.
- ▶ Do not alter the belt fixing devices, automatic seat belt winders and the belt clips.
- ▶ Inspect the screwed connections of the seat belts from time to time in order to ensure that they are correctly seated.
- ▶ Only use one seat belt for **one** adult person.
- ▶ Do not belt in objects together with persons.
- ▶ Seat belts are not sufficient for persons who are less than 150 cm tall. In these cases use additional restraining devices. Observe test certificate.
- ▶ Factory-set three-point safety belts must be used when attaching child restraint systems.
- ▶ After an accident, replace the seat belts.
- ▶ During the journey, do not tilt the backrest too far backwards. Otherwise the functionality of the seat belt is no longer guaranteed.

4.6.1 Fastening the seat belt correctly



- ▶ Do not twist the belt. The belt must be positioned smoothly against the body.
- ▶ When fastening the seat belt, adopt the correct sitting position.

The seat belt is fastened correctly when a fist can be passed between the body and the seat belt.

4.7 Child restraint systems



- ▶ When travelling, secure children under 13 years of age that are smaller than 150 cm, with a suitable and officially approved child restraint system.
- ▶ Factory-set three-point safety belts must be used when attaching child restraint systems.
- ▶ Fasten the childrens' seat belts before commencing the journey and make sure that their seat belts are kept fastened during the journey.
- ▶ If a front passenger airbag is fitted in the vehicle, do not use a child restraint system (Reboard systems) that faces the back of the front passenger's seat. Follow warning notices in the vehicle.

Child restraint systems are divided into five classes:

Class	Body weight	Approximate age
0	Up to 10 kg	Up to 9 months
0+	Up to 13 kg	Up to 18 months
I	9 kg to 18 kg	9 months to 4 years
II	15 kg to 25 kg	3 years to 7 ½ years
III	22 kg to 36 kg	6 years to 12 years

4.8 Pilot seats for the driver's and front passenger's seats



- ▶ Before commencing the journey, rotate all swivel seats in the direction of travel and lock in position.
- ▶ The seats must remain fixed in position during the journey and are not to be rotated.



- ▷ Before rotating the seats in the pitched vehicle, always apply the hand-brake.



- ▷ The driver's seat and the front passenger's seat are part of the base vehicle. The adjustment of the seats is described in the instruction manual of the base vehicle.
- ▷ The possibilities of seat adjustment differ according to the model and equipment variants.

4.9 Headrests



- ▷ The headrests are not adjustable for all models.

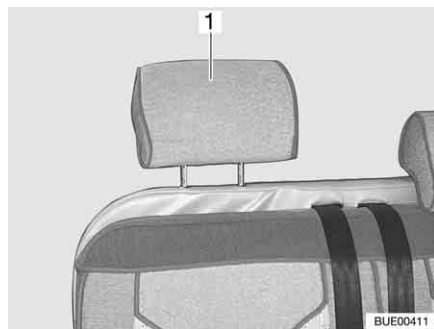

Fig. 23 Bench headrest

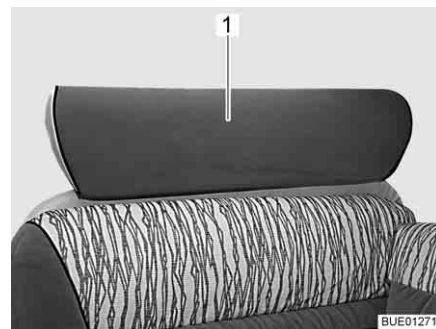

Fig. 24 Bench headrest (alternative)

Before commencing the journey, adjust the headrests (Fig. 23,1) or the headrest (Fig. 24,1) so that the back of the head is supported at approximately ear height. Push the headrests upwards or downwards by hand.

4.10 Seating arrangement



- ▶ During the journey, persons are only to sit on the permitted seats. The authorised number of seats is stipulated in the vehicle documents.
- ▶ During the journey sitting on the divans is not permitted.
- ▶ Seat belts must be worn by all passengers.



Fig. 25 "Seat" symbol

Seats which may be used during travel are equipped with a sticker (Fig. 25).

4.11 Roman shades in the driver's cabin (partially special equipment)



- ▶ While travelling, the Roman shades for the windscreen, driver's window and front passenger's window must be open, in a fixed position and secured.



Fig. 26 Roman shade for the windscreen

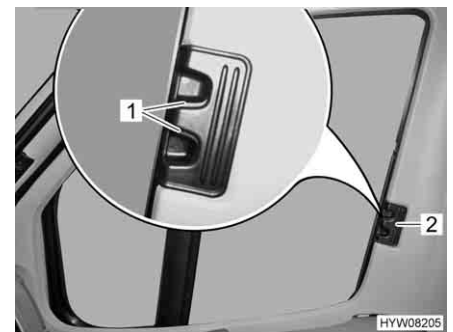

Fig. 27 Roman shade for driver's and passenger's window

Securing:

- Use the handle (Fig. 26,2) to pull the two halves of the Roman shade for the windscreen outwards as far as they will go.
- Allow the release handles (Fig. 26,1) to engage.
- Use handle (Fig. 27,2) to push in the Roman shades for the driver's and passenger's window as far as possible.
- Allow the release handles (Fig. 27,1) to engage.

4.12 Filling up with diesel



- ▶ No appliance operated by a naked flame (e.g. heater or refrigerator) may be in operation when filling the tank, on ferries or in the garage. Danger of explosion!



- ▷ The fuel filler neck is part of the base vehicle.
- ▷ The fuel filler neck is labelled with the word "Diesel".

Refer to the instruction manual for the base vehicle for the position of the fuel filler neck.

Chapter overview

This chapter contains instructions on how to pitch the vehicle.

The instructions address the following topics:

- handbrake
- entrance step
- ramps
- wheel chocks
- operation of the supports
- 230 V connection
- refrigerator
- aligning the antenna
- retracting and extending the awning



- ▷ Pitch the vehicle so that it is as horizontal as possible. Use ramps where necessary. Otherwise, the water from the shower tray will not be able to drain properly.
- ▷ Secure the vehicle to prevent it from rolling.
- ▷ Animals (especially mice) can cause great damage to the interior of the vehicle. To prevent this from happening, regularly check the vehicle for damages or animal traces after pitching.

5.1 Handbrake

Firmly apply the handbrake when parking the vehicle.

5.2 Entrance step



- ▷ Observe the instructions in section 3.6.

In order to exit the vehicle, first fully extend the electrically operated entrance step. Observe the indicator lamp on the dashboard.

5.3 Ramps



- ▷ Ramps are not included in the scope of delivery. Different models are available from accessory shops.

To enable the vehicle to be parked on the level, ramps can be used for height compensation when the vehicle is parked on a hill or on uneven ground.

5.4 Wheel chocks

When parking the vehicle on slopes or inclines use the wheel chocks.

If the maximum permissible gross weight of the vehicle exceeds 4 tonnes, wheel chocks must be used when parking on gradients. The wheel chocks are provided as standard for vehicles with a maximum permissible gross weight exceeding 4 tonnes.

5.5 Supports

5.5.1 General instructions



- ▶ The steady legs must not be used to jack up the vehicle in order to work beneath it, e.g. to change a wheel or carry out maintenance work.
- ▶ Whilst the vehicle is in a jacked up position, persons must not lie down under it.



- ▷ Always apply the handbrake before extending the steady legs.
- ▷ Do not use the fitted supports as a vehicle jack. They supports are only for stabilising the parked vehicle to prevent the rear axle from bottoming out.
- ▷ When pitching the vehicle, ensure that the supports are evenly loaded.
- ▷ Before driving away, wind up the supports as far as they can go, fully retract and secure them.



- ▷ When the ground is soft, place a pad or block under the supports in order to prevent the vehicle from sinking into the ground.
- ▷ Pitch the vehicle so that it is as horizontal as possible. Otherwise, the water from the shower tray will not be able to drain properly.

5.5.2 Steady legs (SAWIKO) (special equipment)



- ▷ Depending on the model, the hexagonal nut has a joint, which can be used to bring the attached socket spanner into a more convenient position for turning.

In order to ensure their correct function, clean and grease the interior tubes of the steady legs regularly.

The length of the steady legs can be adjusted according to the model.

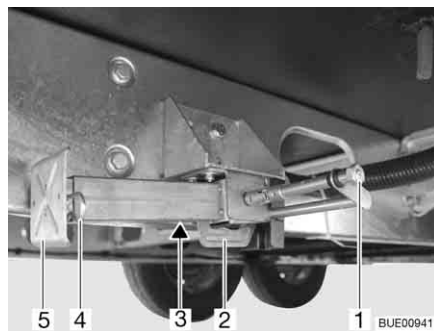

Fig. 28 Steady leg

Extending:

- Place the socket spanner on the hexagonal nut (Fig. 28,1) and rotate until the steady leg is in a perpendicular downward position.
- If the length of the steady leg can be adjusted, remove the splint (Fig. 28,4) out of the support foot extension (Fig. 28,5).
- Pull out the support foot extension until it has reached the required length.
- Insert the splint in the support foot extension.
- Rotate the hexagonal nut until the steady leg rests completely on the ground and the vehicle is in a horizontal position.

- Retracting:*
- Place the socket spanner on the hexagon nut (Fig. 28,1) and rotate until the steady leg is clear of the ground.
 - If the length of the steady leg can be adjusted, remove the splint (Fig. 28,4) out of the support foot extension (Fig. 28,5).
 - Push in the support foot extension (Fig. 28,5) and insert the splint (Fig. 28,4) in the drilled hole in the support foot extension.
 - Rotate the hexagonal nut (Fig. 28,1) until the steady leg has swung upwards and the guide (Fig. 28,2) has reached the very end of the slot (Fig. 28,3).



- ▷ Before commencing the journey, observe the following: Are all steady legs and support foot extensions retracted completely and secured with the splint?

5.5.3 Steady legs (AL-KO) (special equipment)



- ▷ Depending on the model, the hexagonal nut has a joint, which can be used to bring the attached socket spanner into a more convenient position for turning.

In order to ensure their correct function, clean and grease the interior tubes of the steady legs regularly.

The length of the steady legs can be adjusted according to the model.

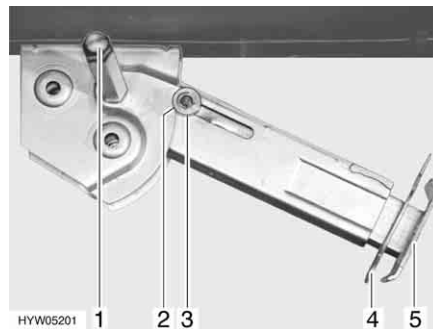

Fig. 29 Steady leg

- Extending:*
- Place the socket spanner on the hexagon nut (Fig. 29,1) and rotate until the steady leg is in a perpendicular downward position.
 - Remove the splint (Fig. 29,4) out of the support foot extension (Fig. 29,5).
 - Extend the support foot extension until it has reached the required length.
 - Insert the splint in the support foot extension.
 - Rotate the hexagonal nut until the steady leg rests completely on the ground and the vehicle is in a horizontal position.

- Retracting:*
- Place the socket spanner on the hexagon nut (Fig. 29,1) and rotate until the steady leg is clear of the ground.
 - Remove the splint (Fig. 29,4) out of the support foot extension (Fig. 29,5).
 - Push in the support foot extension (Fig. 29,5) and insert the splint (Fig. 29,4) in the drilled hole in the support foot extension.
 - Rotate the hexagonal nut (Fig. 29,1) with the socket spanner until the steady leg has swung upwards and the guide disc (Fig. 29,3) has completely retracted into the notch (Fig. 29,2).



- ▷ Before commencing the journey, observe the following: Are all steady legs and support foot extensions retracted completely and secured with the splint?

5.5.4 Electrical steady legs (AL-KO) (special equipment)



- ▶ Always observe the electrical steady legs when extending or retracting them.
- ▶ When extending or retracting the steady legs, ensure that no one is in the vehicle. Risk of injury due to unexpected rolling motion.



- ▷ Never extend the steady legs so far that the tyres of the vehicle are not in contact with the ground. This could damage the body and chassis and the brakes will not work.
- ▷ The steady legs are designed only to support the vehicle, not to level it.
- ▷ Steady legs need sufficient ground clearance to be able to fold out vertically.



- ▷ The electrical steady legs can only be operated with the ignition switched off.
- ▷ If the remote control is not operated for two minutes after the controller has been activated, the controller automatically switches off.
- ▷ When a key on the remote control is pressed, the indicator lamp flashes.
- ▷ If the steady legs are extended and the ignition is switched on, a pulsating warning tone is heard. The warning tone stops after the ignition has been switched off.



Fig. 30 Remote control for electrical steady legs

Button functions

- Preselection: steady leg left (Fig. 30,4)
- Preselection: steady leg right (Fig. 30,2)
- Retract steady leg (Fig. 30,1)
- Extend steady leg (Fig. 30,3)
- Control LED (Fig. 30,5)

Each time a button is pressed, the control LED (Fig. 30,5) flashes.

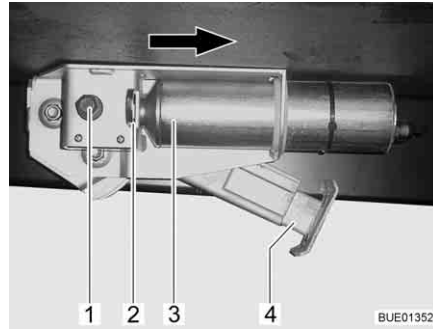

Fig. 31 Electrical steady leg on vehicle



- ▷ Do not extend the steady leg to the end position without it being in contact with the ground.

Extending:

- Press the push button for approx. 2 seconds until a brief sound is emitted. The steady legs control is now activated.
- Press and hold the preselection button for the steady leg side (Fig. 30,2 or 4) for approx. 1 second.
- Within 2 seconds, press the "Extend steady leg" button (Fig. 30,3) and hold it until the support leg (Fig. 31,4) is touching the ground.
- Press the preselection button for the other steady leg side and repeat the procedure.

Retracting:

- Press the push button for approx. 2 seconds until a brief sound is emitted. The steady legs control is now activated.
- Press and hold the preselection button for the steady leg side (Fig. 30,2 or 4) for approx. 1 second.
- Within 2 seconds, press the "Retract steady leg" button (Fig. 30,1) and hold it until the support leg (Fig. 31,4) is fully retracted. Once the support leg is fully retracted, a control signal sounds.
- Press the preselection button for the other steady leg side and repeat the procedure.

Changing the remote control battery:

- Remove the rear casing.
- Change the battery (CR2032). Observe the correct polarity ("+" to the outside).



- ▷ The battery must be changed if the control LED flashes more slowly or if it goes out.

Emergency operation

If the electric drive breaks down, the steady legs can be moved with the hand crank.

Extending/retracting:

- Press the securing bracket (Fig. 31,2) inwards.
- Push the motor (Fig. 31,3) in the direction indicated as far as it will go.
- Extend or retract the steady leg like a mechanical steady leg via the hexagonal nut (Fig. 31,1).

When the fault has been rectified: Push the motor in the opposite direction of the arrow to its initial position. Pull out the securing bracket (Fig. 31,2) until it engages.



- ▷ Further information can be obtained in the manufacturer's instruction manual.

5.6 230 V connection

The vehicle can be connected to a 230 V power supply (see chapter 8).

5.7 Refrigerator



- ▶ If the refrigerator is set to 12 V operation, it will constantly consume current. Therefore, switch over to gas operation when the vehicle engine is **not** running, and the vehicle is **not** connected to the 230 V power supply.

For units with an automatic power selection, the 12 V operation of the refrigerator only functions in the automatic mode when the vehicle engine is running. When the vehicle engine is switched off, switch the refrigerator to 230 V operation or gas operation.

5.8 Satellite unit (special equipment)



- ▶ Before commencing the journey, ensure that the antenna is in park position. Danger of accidents!



- ▷ The vehicle must be still during the satellite search. Do not walk through the vehicle.
- ▷ Satellite reception is only possible, when the antenna is positioned in direct line of sight of the chosen satellite and the view is not blocked in any way.
- ▷ Further information can be obtained in the device manufacturer's instruction manual.

5.8.1 Equipment with automatic antenna alignment (Alden)

The satellite unit is equipped with an automatic positioning unit. This automatic positioning unit ensures that the antennas are aligned accurately.

The flat screen incorporates a digital receiver.

The satellite unit is operated via remote control.

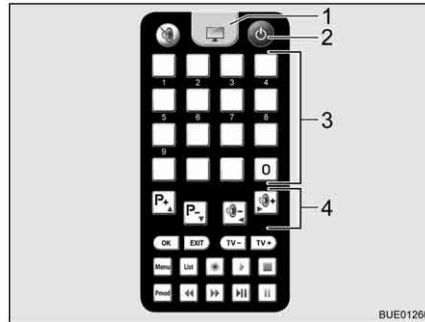

Fig. 32 Remote control

Setting up the unit:

- Switch on the television.
- Press the key "⏻" (Fig. 32,2) on the remote control. The satellite antenna repositions itself out of the park position and into search mode. When the unit finds the satellite, you will hear a signal tone.
- Use the memory buttons (Fig. 32,3) or the function buttons (Fig. 32,4) to set the required transmitter.

5.8.2 Equipment with semi-automatic antenna alignment (Alden)

The satellite unit is equipped with a semi-automatic positioning unit.

The flat screen incorporates a digital receiver.

The satellite unit is operated via remote control.

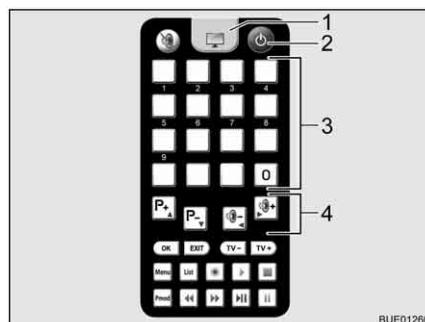

Fig. 33 Remote control for television

Switching on the satellite unit:

- Switch on the television.
- Press the key "⏻" (Fig. 33,2) on the remote control for the television. The unit switches to search mode. You will hear a continuous tone.
- Press the key "⬆️" on the remote control for the antenna. The satellite antenna lifts out of the park position and moves to the last position entered.
- To switch to television reception on the TV remote control, press the TV button (Fig. 33,1). The signal tone will stop. An image will appear on the screen.

Setting up the antenna:

- Use the memory buttons (Fig. 33,3) on the TV remote control or the function buttons (Fig. 33,4) to select the desired station.
- On the remote control for the antenna, use the keys "⬆️" or "⬇️" to correct the angle of the antenna in accordance with the enclosed cards.
- Loosen antenna mast clamp.

Lowering the antenna for driving:

- Turn antenna slowly. When the antenna finds the satellite, you will hear a signal tone.
- Optimise the reception by turning and tilting the antenna.
- Slightly retighten the antenna mast clamp.
- Loosen antenna mast clamp.
- Turn the antenna until the slot in the clamp and the slot in the antenna mast are congruent with each other.
- Press the key "↓" on the remote control for the antenna. The satellite antenna moves into park position.
- Check whether the antenna is fully lowered and points to the rear of the vehicle.
- Slightly retighten the antenna mast clamp.
- Switch off the television.

5.8.3 Equipment with automatic antenna alignment (Oyster)



- ▶ Before commencing the journey, ensure that the antenna is in park position. Danger of accidents!



- ▷ The vehicle must be still during the satellite search. Do not walk through the vehicle.
- ▷ Satellite reception is only possible, when the antenna is positioned in direct line of sight of the chosen satellite and the view is not blocked in any way.
- ▷ Also read the manufacturer's instruction manual.

The satellite unit is equipped with an automatic positioning unit. This automatic positioning unit ensures that the antennas are precisely aligned to the desired satellites.

Operation is menu-controlled (TV screen) using the remote control.

Setting up the unit:

- Switch on the television.
- Use the mains switch to switch on the receiver. When the green LED on the receiver's infra-red receptor lights up, the receiver is ready to operate.
- Switch on the receiver with the remote control. The satellite antenna repositions itself out of the park position and into search mode.

When the system finds the satellite, the selected TV programme appears automatically.

5.9 Awning (special equipment)



- ▷ Retract the awning in strong wind, rain or snow.
- ▷ In the case of light rain, shorten one of the support legs so that water can run off.
- ▷ Only retract the awning when the fabric is dry. When the awning must be retracted while the fabric is still wet: Extend the awning as soon as possible, in order to dry out the fabric.
- ▷ Before retracting, remove leaves and coarse dirt from the awning.



- ▷ Only use the awning for protection against the sun.
- ▷ Also read the manufacturer's instruction manual.

Advantages of the awning

The advantages of an awning are:

- The awning provides shade.
- The awning creates a covered vestibule and thus expands the space.
- The vehicle thus becomes more homelike.



Fig. 34 Awning

Putting up the awning:

- Use the manual crank to open up the awning (Fig. 34,1).
- Set up the brackets (Fig. 34,2) when the awning is open.

Chapter overview

This chapter contains instructions about living in the vehicle.

The instructions address the following topics:

- opening and closing the doors and flaps
- light switches
- adjusting the halogen spotlights
- positioning the television
- ventilation of the vehicle
- opening and closing the windows and blinds
- opening and closing the Roman shades in the driver's cabin
- opening and closing the skylights
- modifying the table surfaces
- converting tables
- the adjustment mechanism of the divan
- use of the beds

6.1 Conversion door



▶ Only drive with locked doors.



- ▷ Locking the doors can prevent them from opening of their own accord, e.g. during an accident.
- ▷ Locked doors also prevent forced entry, e.g. when waiting at traffic lights. However, in an emergency, locked doors make it more difficult for helpers to enter the vehicle.
- ▷ When leaving the vehicle, always lock the doors.

6.1.1 Conversion door, outside (Hartal M1)

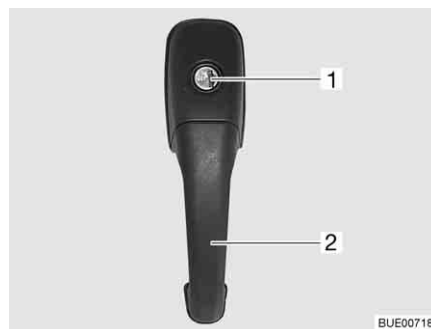

Fig. 35 Door lock of conversion door, outside

- Opening:**
- Insert the key into locking cylinder (Fig. 35,1) and turn until the door lock is unlatched.
 - Return the key to the central position and remove it.
 - Pull on the handle (Fig. 35,2). The door is open.
- Locking:**
- Insert the key into locking cylinder (Fig. 35,1) and turn until the door lock is engaged.
 - Return the key to the central position and remove it.

6.1.2 Conversion door, inside (Hartal M1)



Fig. 36 Door lock of conversion door, inside, locked

Opening: ■ Press lever (Fig. 36,2).

Locking: ■ Push the sliding trap (Fig. 36,1) down.

6.1.3 Conversion door, outside (Hartal Premium) (partially special equipment)

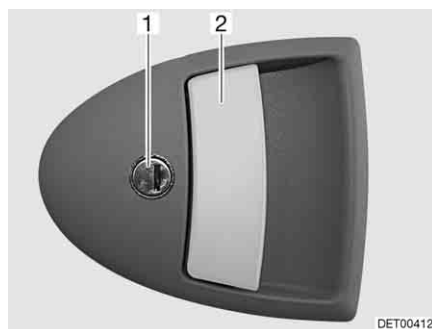

Fig. 37 Door lock of conversion door, outside

Opening: ■ Insert the key into locking cylinder (Fig. 37,1) and turn until the door lock is unlatched.
 ■ Return the key to the central position and remove it.
 ■ Pull on the handle (Fig. 37,2). The door is open.

Locking: ■ Insert the key into locking cylinder (Fig. 37,1) and turn until the door lock is engaged.
 ■ Return the key to the central position and remove it.

6.1.4 Conversion door, inside (Hartal Premium) (partially special equipment)

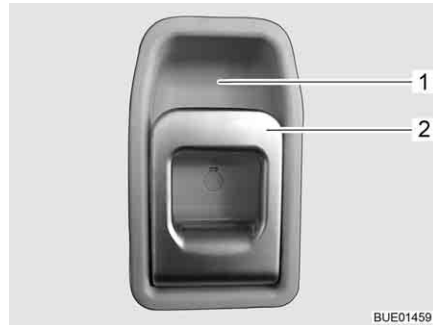

Fig. 38 Door lock of conversion door, inside

- Opening:*
- Pull on the handle (Fig. 38,2). The door lock is unlatched.
- Locking:*
- Press the upper part of the handle (Fig. 38,2) in the direction of the recessed handle (Fig. 38,1).

6.1.5 Window of conversion door (Hartal Premium) (partially special equipment)

The conversion door window is fitted with a Roman shade.

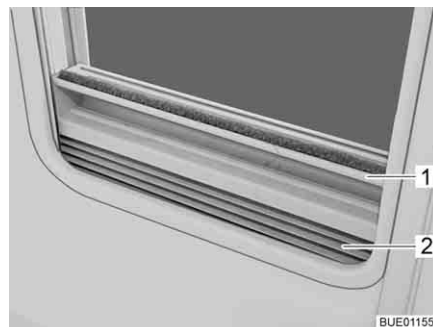

Fig. 39 Roman shade

- Closing:*
- Grip the Roman shade (Fig. 39,2) in the middle of the holding bar (Fig. 39,1), pull it upwards and then release it at the desired height. The Roman shade will stay at this height.
- Opening:*
- Grip the Roman shade in the middle of the holding bar and push it down.

6.1.6 Folding insect screen on the conversion door (partially special equipment)



- ▷ Open the insect screen completely before closing the conversion door.



Fig. 40 Insect screen

- Closing:* ■ Pull out the insect screen completely by the bar (Fig. 40,1).
- Opening:* ■ Push the insect screen into its initial position by the bar (Fig. 40,1).

6.2 External flaps



- ▷ Before commencing the journey, close all external flaps and lock them.
- ▷ To open and close the external flap, open or close all locks that are fitted to the external flap.



- ▷ When leaving the vehicle, close all external flaps.

The external flaps fitted to the vehicle are all fitted with identical locking cylinders. Therefore, all locks can be opened with a single key.

6.2.1 Flap lock with recessed handle



- ▷ To open the external flap, pull all the lock handles fitted to that particular external flap at the same time.

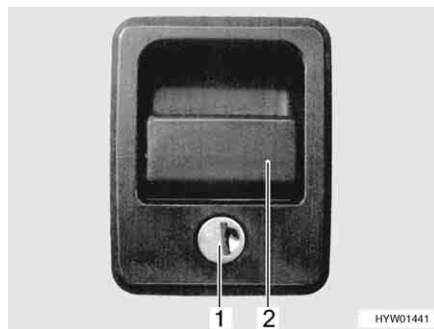

Fig. 41 Flap lock with recessed handle

- Opening:* ■ Insert key into locking cylinder (Fig. 41,1) and turn a quarter turn. The flap lock is unlatched.
- Remove the key.
 - Pull on the lock handle (Fig. 41,2). The external flap is open.

- Closing:*
- Firmly close the external flap.
 - Insert key into locking cylinder and turn a quarter turn. The flap lock is locked.
 - Remove the key.

6.2.2 Flap lock with push button

Depending on the flap size the service flap is equipped with one or two lockable push-button locks.

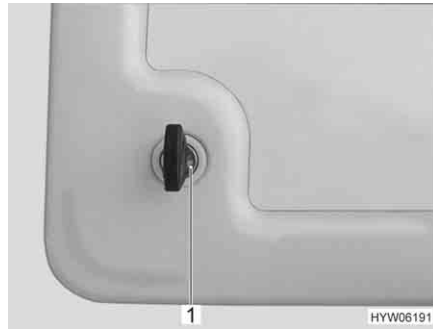

Fig. 42 Push-button lock service flap

- Opening:*
- Insert the key into locking cylinder of the lockable push-button lock (Fig. 42,1) and turn a quarter turn. The push-button lock is unlatched.
 - Remove the key.
 - If equipped, unlock the second lockable push-button lock as well.
 - Press the two push buttons of the push-button locks simultaneously with the thumb and open the service flap.
- Closing:*
- Close the service flap and press it shut. The push-button locks are now engaged but not locked.
 - Insert the key into locking cylinder of the lockable push-button lock (Fig. 42,1) and turn a quarter turn. The push-button lock is locked.
 - Remove the key.
 - If equipped, lock the second lockable push-button lock as well.

6.2.3 Flap for the 230 V connection, square



- 1 Recessed grip
- 2 External flap

Fig. 43 Flap for the 230 V connection

- Opening:*
- Reach into the recessed grip (Fig. 43,1) on the external flap (Fig. 43,2) and swing the external flap upward.
- Closing:*
- Swivel the external flap downwards and press it shut.

6.2.4 Cap for the drinking water filler neck

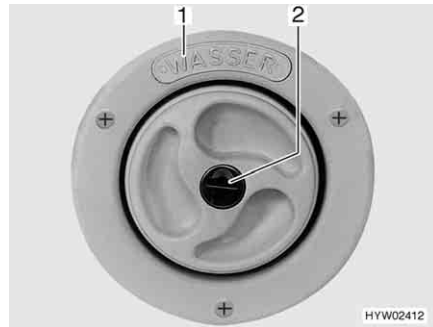

Fig. 44 Cap for the drinking water filler neck

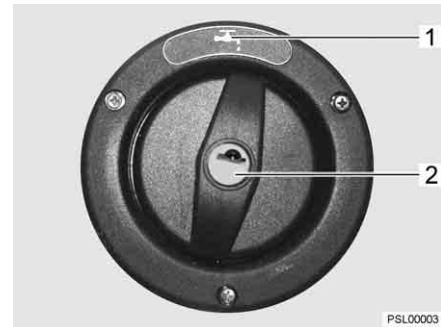

Fig. 45 Cap for the drinking water filler neck (alternative)



- ▷ The drinking water filler neck is labelled by the word "WASSER" (water) (Fig. 44,1) or marked by the symbol "☰" (Fig. 45,1).

Opening:

- Insert the key in the locking cylinder (Fig. 44,2 or Fig. 45,2) and turn it in an anticlockwise direction.
- Remove cap.

Closing:

- Insert the cap in the drinking water filler neck.
- Turn key in a clockwise direction.
- Remove the key.

6.3 Furniture flaps



- ▷ Before commencing the journey, close all furniture flaps and inner doors and lock them.
- ▷ The furniture flaps shown in this section are examples. Depending on the model, the locks and handles on the furniture flaps may differ to those displayed here.

6.3.1 Furniture flaps with push button



Fig. 46 Furniture flap with push button

Opening:

- Press inner part of the lock. The push button jumps out (Fig. 46).
- Hold push button and open furniture flap.

- Closing:*
- Press furniture flap shut.
 - Press push button in until it locks. The furniture flap is closed correctly when the fastener locks into place.

6.3.2 Furniture flaps with handle and push button

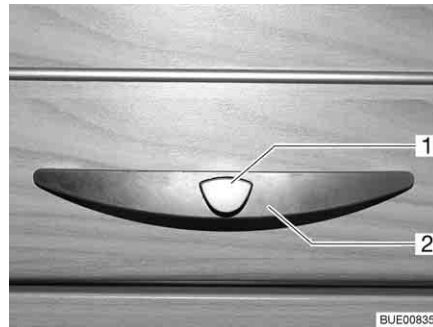

Fig. 47 Furniture flap with handle (example)

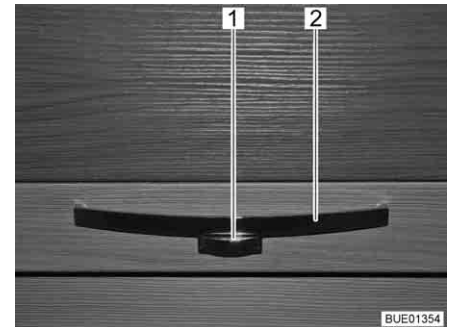

Fig. 48 Furniture flap with handle (example)

- Opening:*
- Press the release knob (Fig. 47,1 or Fig. 48,1) on the handle (Fig. 47,2 or Fig. 48,2) and hold it down.
 - Pull handle until furniture flap is open.

- Closing:*
- Press the furniture flap down until you can feel the flap hinge close and hear the lock snap into place.

6.3.3 Furniture flaps with release handle

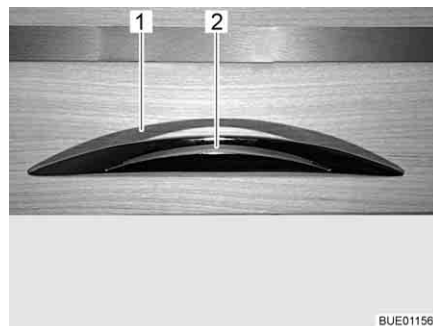

Fig. 49 Furniture flap with release handle

- Opening:*
- Press the release handle (Fig. 49,2) and hold it down.
 - Pull the release handle (Fig. 49,1) until the furniture flap is open.

- Closing:*
- Press the furniture flap down until you can feel the flap hinge close and hear the lock snap into place.

6.4 Light switch

6.4.1 Entrance area



- ▷ The light switches shown in this section are examples. Depending on the model, the type and allocation of the light switches may differ to those displayed here.

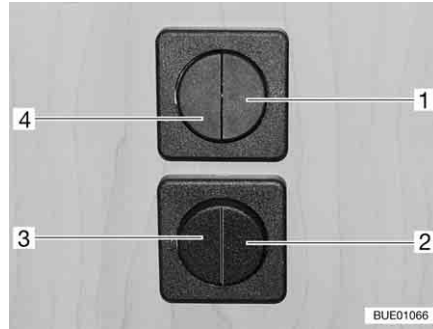

Fig. 50 Light switch



Fig. 51 Awning light

The entrance area has light switches for the following lamps:

- Seating group lights (Fig. 50,1)
- Entrance lights (Fig. 50,2)
- Awning lights (Fig. 50,3)
- Living area lights (Fig. 50,4)

6.4.2 Interior



- ▷ The lamps shown in this section are examples. Not all lamps used in the vehicle are shown. The examples are intended to clarify the possible positions for the light switches. The type and appearance of the light switches can deviate from those shown here.

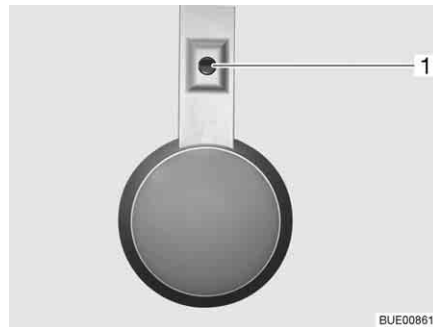

Fig. 52 Lamp, switch mounted directly on the lamp



Fig. 53 Halogen spotlight, light switch directly on the lamp



Fig. 54 Halogen lamp



Fig. 55 Recessed halogen light

The interior light switches are located either directly on each lamp (Fig. 52,1, Fig. 53,1 and Fig. 54,1) or near the lamp (Fig. 55,1).

6.4.3 Wardrobe light



- ▷ The wardrobe light can be removed from its holder (Fig. 56,1) and used as a torch.
- ▷ When the wardrobe door is closed, the wardrobe light switches off automatically.
- ▷ A brightness sensor ensures that the wardrobe light comes on only when it is dark. This prevents the wardrobe light from being accidentally switched on during daylight hours, which would waste the batteries.

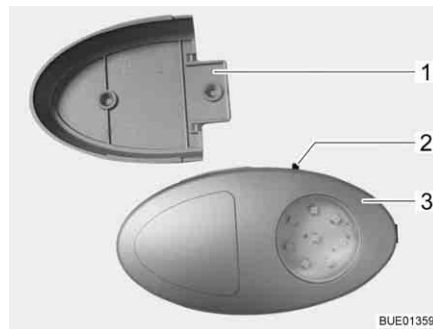

Fig. 56 Wardrobe light

The On/Off switch (Fig. 56,2) is located directly on the wardrobe light (Fig. 56,3).

6.5 Spotlight



- ▶ Bulbs and light fittings can be extremely hot.
- ▶ Allow the light bulbs and lamp holders to cool down before touching them.
- ▶ If the light is switched on or still hot, there must always be a safety distance of at least 30 cm between stores or curtains and flammable objects. Fire hazard!

Variant 1 The spotlight can be rotated and moved.

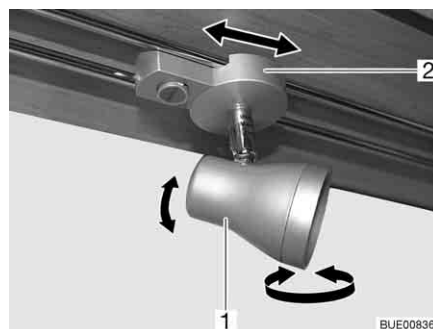

Fig. 57 Spotlight

Turning: ■ Grasp the housing (Fig. 57,1) and turn it.

The housing can be turned in different directions:

- To the left and to the right
- Up and down

- Shifting:*
- Grasp the holder (Fig. 57,2).
 - Push spotlight along the rail system to desired position.

Variante 2 The spotlight can be rotated, moved or detached.

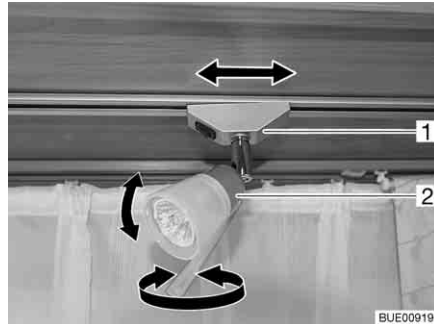

Fig. 58 Spotlight

- Turning:*
- Grasp the housing (Fig. 58,2) and turn it.
- The housing can be turned in different directions:
- To the left and to the right
 - Up and down
- Shifting:*
- Grip holder (Fig. 58,1) and turn by approx. 45°.
 - Push spotlight along the rail system to desired position.
- Removal:*
- Grip holder (Fig. 58,1) and turn by approx. 90°.
 - Remove spotlight from rail.

The spotlight can be installed in any position into the rails.

6.6 Holder for flat screen



- ▶ Before commencing the journey, place and secure the flat screen and screen support in the initial position. If the screen holder is installed in a TV cabinet: Close TV cabinet.



- ▷ If there is a risk of frost, do not leave the flat screen television in the vehicle.

6.6.1 Holder on the column

The holder for the flat screen is attached to a column.

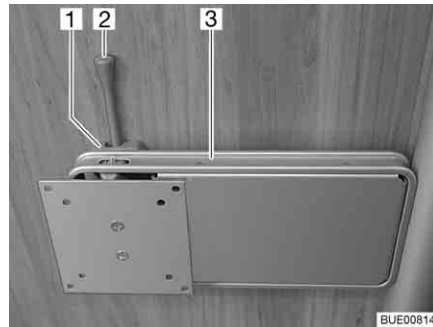

Fig. 59 Holder on the column

Positioning:

- Push the release lever (Fig. 59,2) to the side and turn the holder (Fig. 59,3) with the flat screen to the desired position.
- Press flat screen slightly upward and swivel it to the desired position. Three different inclination angles may be used.

Storing away:

- Turn flat screen back until the holder (Fig. 59,3) engages in the lock (Fig. 59,1).

6.6.2 Holder with jointed arm

The flat screen is fastened to a jointed arm.

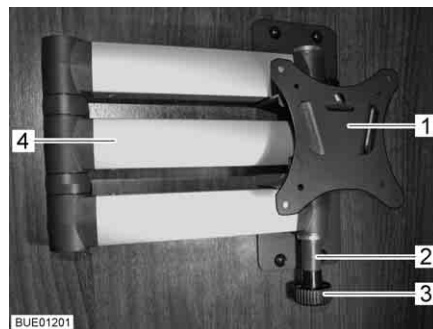

Fig. 60 Holder with jointed arm

Positioning:

- Pull the release knob (Fig. 60,3). The jointed arm (Fig. 60,4) is unlocked.
- Swivel flat screen into the desired position.
- Take hold of the flat screen at the top and bottom edge with both hands and set the desired angle of inclination.

Storing away:

- Turn the flat screen back into the original position until the holder (Fig. 60,1) engages in the lock (Fig. 60,2).

6.6.3 Holder in the TV cabinet

The flat screen is attached to a console in the TV cabinet.

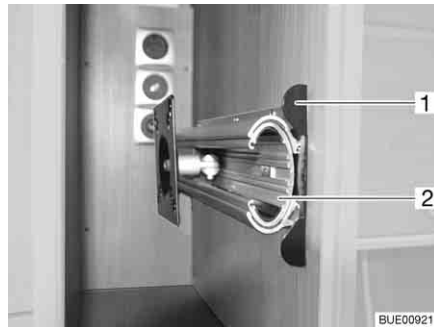

Fig. 61 Holder in the TV cabinet

Positioning:

- Push the unlocking bar (Fig. 61,1) in.
- Pull out the extension (Fig. 61,2) as far as possible.
- Swivel flat screen into the desired position.

Storing away:

- Swing back flat screen into its original position.
- Push in the extension (Fig. 61,2) until the unlocking bar (Fig. 61,1) engages.

6.6.4 Holder in the TV compartment

The flat screen is fixed to a lifting mechanism in the TV compartment.

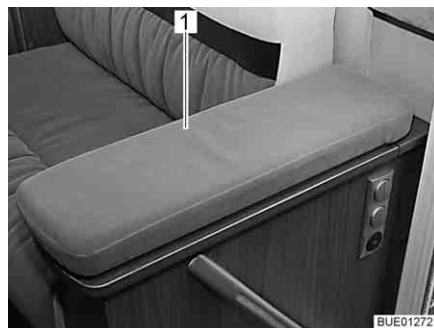

Fig. 62 TV compartment

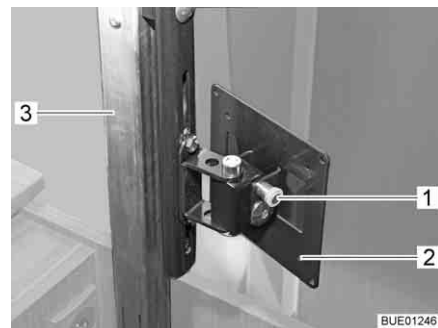

Fig. 63 Lifting mechanism

Positioning:

- Lightly depress the cover (Fig. 62,1) of the TV compartment in the centre. The extension column (Fig. 63,3) is released and starts to move upwards.
- Pull the release knob (Fig. 63,1) and swivel holder (Fig. 63,2) with flat screen to the desired position.

Storing away:

- Turn the flat screen back into the original position until holder (Fig. 63,2) engages in the lock.
- Press the middle of the cover (Fig. 62,1) downwards against the resistance of the extension column (Fig. 63,3) until the locking mechanism engages.

6.7 Ventilation



- ▶ The oxygen in the vehicle interior is used up by breathing and the use of gas operated appliances. That is why the oxygen needs to be replaced on a constant basis. For this purpose, forced ventilation options (e.g. skylights with forced ventilation, mushroom-shaped vents or floor vents) are fitted to the vehicle. Never cover or block forced ventilations from the inside or outside with objects such as e.g. a winter mat. Keep forced ventilations clear of snow and leaves. There is a danger of suffocation due to increased CO₂ levels.



- ▷ Although sufficient ventilation is provided, in certain weather conditions, condensation can form on metal objects (e.g. screwed connections in the floor).
- ▷ Additional cold spots can occur at thermal "bridges" (e.g. mushroom-shaped vents, skylight edges, sockets, filler necks, flaps, etc.).

Condensation

Ensure that there is a continuous exchange of air by providing frequent and efficient ventilation. This is the only method for ensuring that condensation and resulting mould is not formed during cool weather. During the colder season, a pleasant living climate is created if heating output, air distribution and ventilation are synchronised. To avoid draft close the air outlet nozzles on the dashboard and set the air distribution of the base vehicle to air circulation.

If the vehicle is laid up for a longer period, occasionally ventilate it well, especially in summer as heat accumulation can occur. Do not only air the interior, but also the storage compartments which are accessible from the outside. Air the parking place as well if the vehicle is parked in a closed space (e.g. garage). The occurrence of condensation could lead to the formation of mould.

6.8 Windows



- ▷ The windows are fitted with a blind or Roman shade and with an insect screen or folding insect screen. After the latch has been released, the blind and insect screen automatically spring back to the initial position by tensile force. In order not to damage the tension mechanics, hold onto the blind or insect screen and allow it to slowly return to the initial position. The Roman shade and folding insect screen are made of thin woven fabric. In order not to damage the Roman shade or the insect screen, grasp the respective handle and carefully return it to the initial position.
- ▷ Do not keep blinds closed over a longer period of time as that can cause increased material wear.
- ▷ If the blind or the Roman shade is completely closed, exposure to direct sunlight can cause heat to accumulate between the blind/the Roman shade and the window. The window could be damaged.
Therefore, if the shade is installed in the bottom blind box, close the shade only 2/3 when sunlight is intense. This allows the heat to escape between the window and the shade.
If the shade is installed in the top blind box, close the shade fully and open it regularly.
Also move the window into the "continuous ventilation" position.
- ▷ Before commencing the journey, close the windows.



- ▷ Depending on the weather, close the windows far enough to prevent moisture from entering.
- ▷ To open and close the window, open or close all catch levers which are fitted to the window.



- ▷ When leaving the vehicle, always close the windows.
- ▷ In extreme weather conditions or if the temperature fluctuates strongly, a light condensation film can form on the double-glazed acrylic glass. The glass is designed in such a way that condensation can evaporate when the external temperature increases. There is no danger of the double-glazed acrylic glass being damaged by condensation.

6.8.1 Hinged window with rotary hinges



- ▷ When opening the hinged windows, ensure that there are no torsional forces. Open and close the hinged windows evenly.

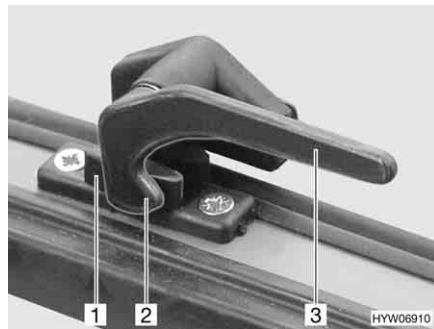

Fig. 64 Catch lever in "closed" position

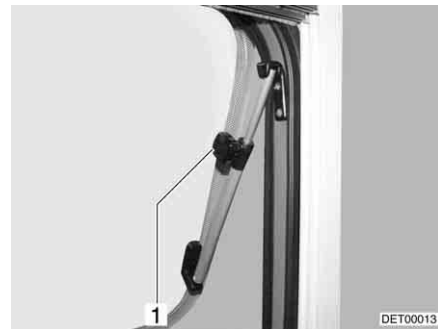

Fig. 65 Hinged window with rotary hinges, open

- Opening:**
- Turn the catch lever (Fig. 64,3) a quarter turn towards the centre of the window.
 - Open the hinged window until the required position has been reached and use knurled knob (Fig. 65,1) to secure in position.

The hinged window remains locked in the required position.

- Closing:**
- Turn knurled knob (Fig. 65,1) until the latch is released.
 - Close the hinged window.
 - Turn the catch lever (Fig. 64,3) a quarter turn towards the window frame. The locking catch (Fig. 64,2) is located on the inside of the window catch (Fig. 64,1).

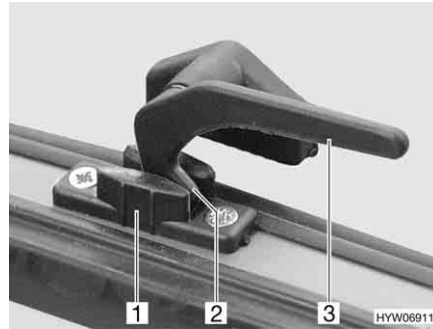

Fig. 66 Catch lever in the "continuous ventilation" position

Continuous ventilation

With the catch lever, the hinged window can be placed in 2 positions:

- "Continuous ventilation" (Fig. 66)
- Firmly closed (Fig. 64)

To place the hinged window into the "continuous ventilation" position:

- Turn the catch lever (Fig. 66,3) a quarter turn towards the centre of the window.
- Lightly open the hinged window outwards.
- Return the catch lever to its initial position. The locking catch (Fig. 66,2) has to be moved into the recess of window catch (Fig. 66,1).

During the journey, the hinged window may not be in "continuous ventilation" position.

If it rains, the "continuous ventilation" hinged window position could lead to splashing water penetrating the living area. Therefore, close the hinged windows completely.

6.8.2 Hinged window with automatic hinges



- ▷ Open the window completely, to release the lock. If the locking device is not released and the window is closed nevertheless, there is the danger of the window breaking due to the massive counter-pressure.
- ▷ When opening the hinged windows, ensure that there are no torsional forces. Open and close the hinged windows evenly.

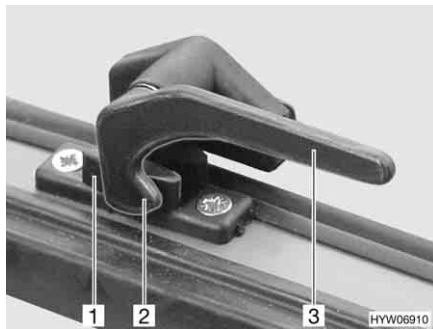

Fig. 67 Catch lever in "closed" position



Fig. 68 Hinged window with automatic hinges, open

- Opening:**
- Turn the catch lever (Fig. 67,3) a quarter turn towards the centre of the window.
 - Open the hinged window to the desired latched position. The automatic hinge (Fig. 68,1) locks in place automatically.

The hinged window remains locked in the required position.

- Closing:**
- Open the hinged window as wide as necessary until the latch releases.
 - Close the hinged window.
 - Turn the catch lever (Fig. 67,3) a quarter turn towards the window frame. The locking catch (Fig. 67,2) is located on the inside of the window catch (Fig. 67,1).

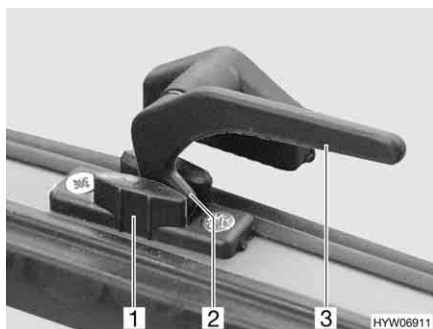

Fig. 69 Catch lever in the "continuous ventilation" position

Continuous ventilation

With the catch lever, the hinged window can be placed in two positions:

- "Continuous ventilation" (Fig. 69)
- Firmly closed (Fig. 67).

To place the hinged window into the "continuous ventilation" position:

- Turn the catch lever (Fig. 69,3) a quarter turn towards the centre of the window.
- Slightly open the hinged window outwards.
- Turn the catch lever a quarter turn towards the window frame. The locking catch (Fig. 69,2) has to be moved into the recess of window catch (Fig. 69,1).

During the journey, the hinged window may not be in "continuous ventilation" position.

If it rains, the "continuous ventilation" hinged window position could lead to splashing water penetrating the living area. Therefore, close the hinged windows completely.

6.8.3 Blind and insect screen



- ▷ Open blinds before commencing the journey. When the blinds are closed, vibrations can damage the spring shaft.

The windows are fitted with a blind and an insect screen. The blind and insect screen are adjusted separately.

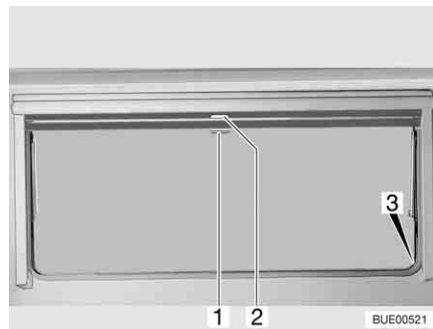

Fig. 70 Hinged window

Blind The blind is located in the upper blind box.

- Closing:*
- Pull blind at the handle (Fig. 70,2) downwards. If the blind is to be completely closed, it is suspended into the locking devices (Fig. 70,3) situated on both sides of the window frame.
- Opening:*
- If the blind is completely closed: Press handle (Fig. 70,2) downwards and, at the same time, tilt it slightly inward. The blind can be taken out of the locking devices situated on both sides of the window frame.
 - If the blind is in an intermediate position: Pull the handle (Fig. 70,2) slightly downwards until the locking device releases.
 - Use handle to return blind slowly to its initial position.

Insect screen The insect screen is located in the upper blind box.

- Closing:*
- Pull insect screen at the handle (Fig. 70,1) down and hang it into the locking devices (Fig. 70,3) situated on both sides of the window frame.
- Opening:*
- Press handle (Fig. 70,1) downwards and, at the same time, tilt it slightly inward. The insect screen can be taken out of the locking devices situated on both sides of the window frame.
 - Use handle to return the insect screen slowly to its initial position.

6.8.4 Roman shade and insect screen

The windows are fitted with a Roman shade and an insect screen. The insect screen can only be moved together with the Roman shade.

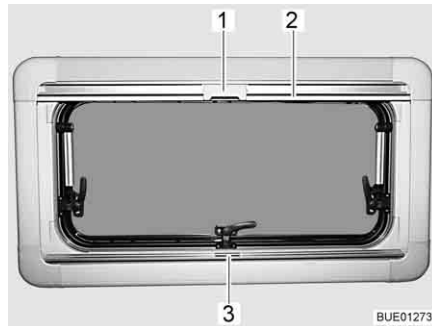

Fig. 71 Hinged window

Roman shade The Roman shade is located in the bottom blind box.

Closing: ■ Grip the Roman shade using the holding bar (Fig. 71,3), pull it from the bottom to the top and then release it at the desired height. The Roman shade will stay at this height.

Opening: ■ Grip the Roman shade in the middle of the bar and push it down.

Insect screen The insect screen is located in the upper blind box.

Closing: ■ Pull the insect screen down using the holding bar (Fig. 71,2), until it touches the holding bar of the Roman shade (Fig. 71,3).
 ■ Clip the catch (Fig. 71,1) on the insect screen into the handle of the Roman shade.

Opening: ■ Push the catch (Fig. 71,1) on the insect screen inwards.
 ■ Move the insect screen back slowly on the holding bar (Fig. 71,2).

6.8.5 Roman shade and insect screen

The windows are fitted with a Roman shade and an insect screen. Roman shade and insect screen are fixed to each other.

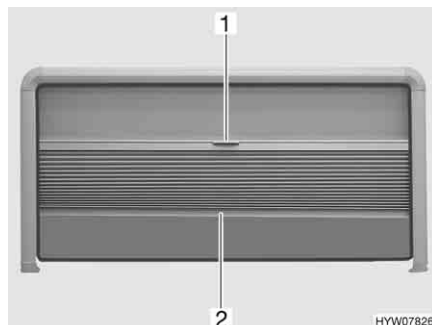

Fig. 72 Hinged window

Roman shade The Roman shade is located in the upper window frame.

Closing: ■ Hold the Roman shade in the centre of the bottom rod (Fig. 72,2) and carefully draw it downwards.

■ Release the Roman shade at the desired position. The Roman shade will stay in that position.

Opening: ■ Hold the bottom rod (Fig. 72,2) of the Roman shade in the centre and carefully slide the Roman shade upwards.

Insect screen The insect screen is located in the upper window frame.

Closing: ■ Carefully pull down the insect screen by the handle (Fig. 72,1).

■ Move the insect screen continuously.

If the insect screen is not drawn fully to the bottom, the Roman shade can be stretched up to the end of the side window frame.

Opening: ■ Slowly push the insect screen on the bottom rod of the Roman shade (Fig. 72,2) all the way up.

6.8.6 Roman shades for windscreen, driver's window and front passenger's window (partially special equipment)

Depending on the model, the driver's cabin is darkened with either curtains or Roman shades.



Fig. 73 Curtain on front passenger's window

The curtains (Fig. 73,2) are fixed with snap fasteners (Fig. 73,1).

The Roman shades are either fixed with magnetic strips or are permanently fitted to the vehicle inside the frame.

Proceed as described below to open or close permanently installed Roman shades.

Windscreen



Fig. 74 Roman shade for the windscreen

- Closing:**
- Press the release handles (Fig. 74,1) and hold them down.
 - Use the handle (Fig. 74,2) to pull the Roman shade for the windscreen towards the centre of the window.
 - Close the second Roman shade for the windscreen in the same way. A magnetic catch holds both parts of the Roman shade together in the centre.
- Opening:**
- Press the release handles (Fig. 74,1) and hold them down.
 - Use the handle (Fig. 74,2) to pull the two halves of the Roman shade for the windscreen outwards as far as they will go.
 - Let go of the release handles (Fig. 74,1) and let them engage.

Driver's window and front passenger's window

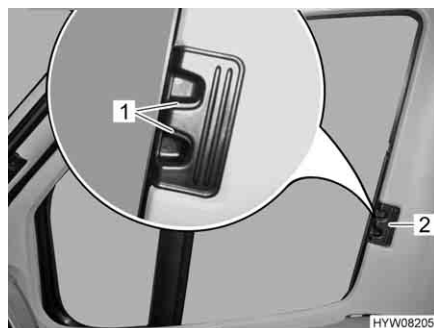

Fig. 75 Roman shade for driver's and passenger's window

- Closing:**
- Press the release handles (Fig. 75,1) and hold them down.
 - Using the handle (Fig. 75,2), draw the Roman shades for the driver's and passenger's window to the other side of the window and secure them to the magnetic strips.
- Opening:**
- Press the release handles (Fig. 75,1) and hold them down.
 - Use handle (Fig. 75,2) to push in the Roman shades for the driver's and passenger's window as far as possible.
 - Let go of the release handles (Fig. 75,1) and let them engage.

6.9 Skylights

Depending on the model, skylights with or without forced ventilation are fitted to the vehicle. If a skylight is fitted without forced ventilation, the forced ventilation is performed using mushroom-shaped vents.



- ▶ The apertures for forced ventilation must always be kept open. Never cover or block forced ventilations with objects such as e.g. a winter mat. Keep forced ventilations clear of snow and leaves.



- ▷ The skylights are fitted with a blind or Roman shade and with an insect screen or folding insect screen. After the latch has been released, the blind and insect screen automatically spring back to the initial position by tensile force. In order not to damage the tension mechanics, hold onto the blind or insect screen and allow it to slowly return to the initial position. The Roman shade and folding insect screen are made of thin woven fabric. In order not to damage the Roman shade or the insect screen, grasp the respective handle and carefully return it to the initial position.
- ▷ Do not keep blinds closed over a longer period of time as that can cause increased material wear.
- ▷ If the blind or the Roman shade is completely closed, exposure to direct sunlight can cause heat to accumulate between the blind/the Roman shade and the skylight. The skylight could be damaged. For that reason, close the blind/Roman shade only 2/3 of the way in direct sunlight. Open the skylight slightly or move it to ventilation position.
- ▷ Depending on the weather, close the skylights far enough to prevent moisture from entering.
- ▷ Do not climb on the skylights.
- ▷ Before commencing the journey, close the skylights.
- ▷ Before commencing the journey, check that the skylights are closed and locked.



- ▷ When leaving the vehicle, always close the skylights.

6.9.1 Heki skylight (mini and midi) (partially special equipment)

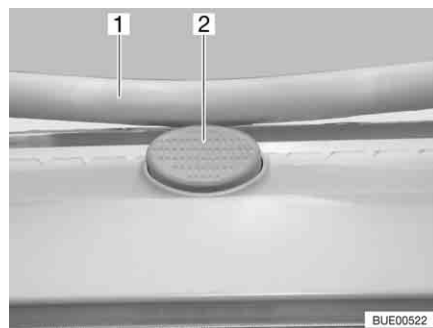

Fig. 76 Safety knob on the Heki skylight

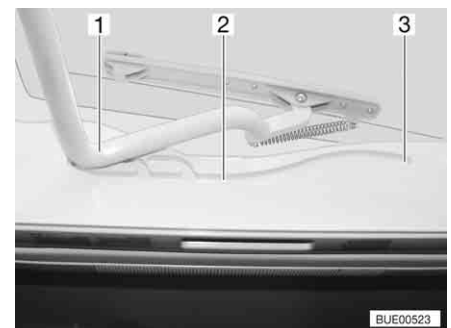

Fig. 77 Heki skylight, guide

The Heki skylight is opened on one side only.

- Opening:*
- Press the safety knob (Fig. 76,2) and pull the bar (Fig. 76,1) down with both hands.
 - Pull the bar (Fig. 77,1) in the guides (Fig. 77,2) to the rearmost position (Fig. 77,3).
- Closing:*
- Use both hands to push the bar (Fig. 77,1) slightly upwards.
 - Push the bar back in the guides.
 - Push the bar upwards with both hands until it is above the safety knob (Fig. 76,2).

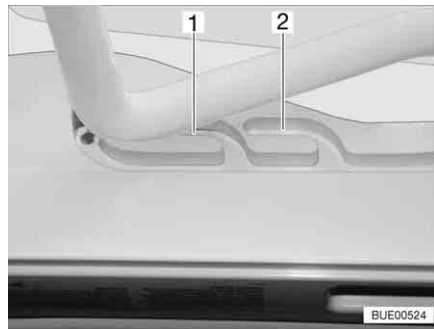

Fig. 78 Heki skylight in ventilation position

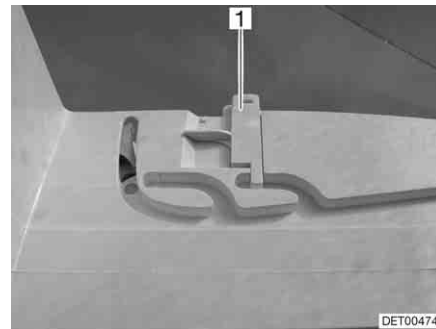

Fig. 79 Ventilation position locking mechanism

Ventilation position

The Heki skylight can be put in two ventilation positions: Bad weather position (Fig. 78,1) and central position (Fig. 78,2). Depending on the model, the skylight can be locked in the central position with the latch (Fig. 79,1).

- Press the safety knob (Fig. 76,2) and pull the bar (Fig. 76,1) down with both hands.
- Pull the bar in the guides (Fig. 77,2) to the desired position.
- Push the bar slightly upwards and into the selected guide (Fig. 78,1 or 2) and lock if necessary.

Roman shade To close and open the Roman shade:

Closing:

- Pull out Roman shade at the handle and release in the required position. The Roman shade will stay in that position.

Opening:

- Slowly push the Roman shade at the handle to its initial position.

Insect screen To close and open the insect screen:

Closing:

- Pull the insect screen by the handle to the opposite handle of the Roman shade.

Opening:

- Press the rear part of the handle of the insect screen. The latch is released.
- Use handle to return the insect screen slowly to its initial position.

6.9.2 Wind-up skylight (special equipment)

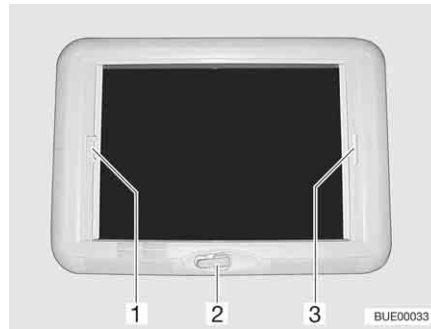

Fig. 80 Wind-up skylight

The wind-up skylight can be opened using the manual crank.

Opening: ■ Rotate the hand crank (Fig. 80,2) until a resistance can be felt.

Closing: ■ Rotate the hand crank until the wind-up skylight is closed. The wind-up skylight can be locked after rotating two or three more times.
 ■ Check the locking mechanism. To do so, press your hand against the acrylic glass.

Roman shade The Roman shade can be closed in any position, as desired. If the Roman shade is locked with the insect screen, the insect screen is also moved along on closing the Roman shade.

Closing: ■ Pull the handle of the Roman shade (Fig. 80,3) and release in the desired position. The Roman shade will stay in that position.

Opening: ■ Slowly push the Roman shade at the handle to its initial position.

Insect screen If the insect screen is locked with the Roman shade, the Roman shade is also moved along on closing the insect screen.

Closing: ■ Pull insect screen at the handle (Fig. 80,1) to the opposite handle of the Roman shade (Fig. 80,3) and allow to engage.

Opening: ■ Press the handle of the insect screen (Fig. 80,1) at the back upwards and detach the insect screen from the Roman shade (Fig. 80,3).
 ■ Slowly push insect screen at the handle to its initial position.

6.9.3 Skyroof skylight (partially special equipment)



- ▷ When opening the skylight, ensure that there are no torsional forces. Open and close the skylight evenly.

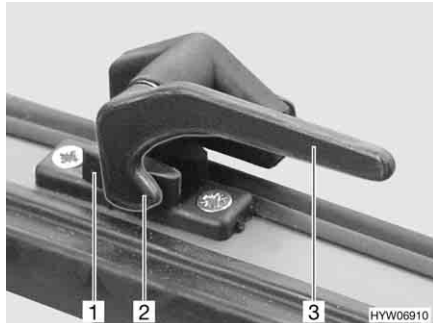

Fig. 81 Catch lever in "closed" position



Fig. 82 Skylight with rotary hinges, open

- Opening:*
- Turn all catch levers (Fig. 81,3) a quarter turn towards the centre of the skylight.
 - Open the skylight until the required position has been reached and use knurled knob (Fig. 82,1) to secure in position.

The skylight remains locked in the desired position.

- Closing:*
- Turn knurled knob (Fig. 82,1) until the latch is released.
 - Close the skylight.
 - Turn all catch levers (Fig. 81,3) a quarter turn towards the frame. The locking catch (Fig. 81,2) is located on the inside of the skylight lock (Fig. 81,1).

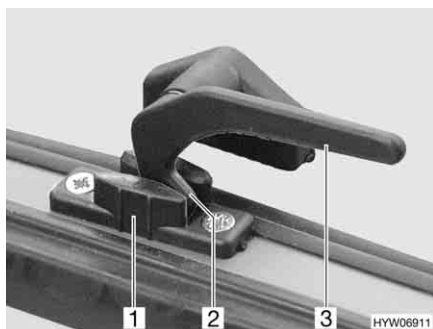

Fig. 83 Catch lever in the "continuous ventilation" position

Continuous ventilation

With the catch levers, the skylight can be placed in 2 different positions:

- "Continuous ventilation" (Fig. 83)
- "Firmly closed" (Fig. 81)

To place the skylight into the "continuous ventilation" position:

- Turn all catch levers (Fig. 83,3) a quarter turn towards the centre of the skylight.
- Slightly push the skylight outwards.
- Return all catch levers to their initial position. The locking catch (Fig. 83,2) has to be moved into the recess of the skylight lock (Fig. 83,1).

During the journey, the skylight may not be in the "continuous ventilation" position.

If it rains, the "continuous ventilation" skylight position could lead to splashing water penetrating the living area. Therefore, close the skylight completely.



Fig. 84 Skyroof skylight

Roman shade The Roman shade is fitted in the frame, at the bottom.

- Closing:*
- Hold the Roman shade in the centre of the bottom rod and carefully draw it upwards.
 - Release the Roman shade at the desired position. The Roman shade will stay in that position.

- Opening:*
- Carefully return the bottom rod of the Roman shade downwards to the limit stop on the frame.

Insect screen The insect screen is fitted in the frame, at the top.

- Closing:*
- Hold the insect screen in the centre of the bottom rod and carefully pull it down.
 - Continuous adjustment of the insect screen may be made by moving the bottom rod.

- Opening:*
- Carefully return the bottom rod of the insect screen upwards to the limit stop on the frame.

6.10 Tables

6.10.1 Suspension table with separable support leg



Fig. 85 Suspension table with separable support leg

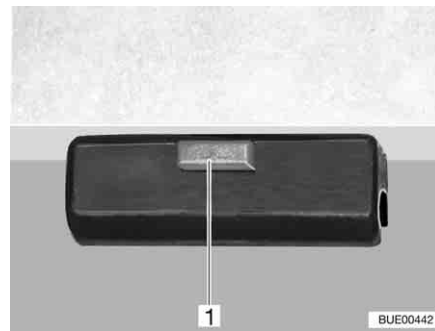

Fig. 86 Lock

The suspension table size can be enlarged by swinging out a table-top extension.

Extending: ■ Pull the knob (Fig. 85,2) of the lock down and swing out the table-top extension (Fig. 85,1).

Reducing size: ■ Swing the table-top extension (Fig. 85,1) under the table-top (Fig. 85,6) until the lock latches in place audibly.

The suspension table's separable support leg enables it to be used as a bed foundation.

Conversion to bed foundation:

- Lift the front of the table-top (Fig. 85,6) by approx. 45°.
- Pull out the lower part of the support leg (Fig. 85,4) down and lay aside.
- Release the lock (Fig. 86,1) on the table top.
- Remove the table-top from the upper retainer.
- Hook the table-top at a 45° angle to the supports into the lower retainer (Fig. 85,3) and place on the floor with the upper part of the support leg (Fig. 85,5).
- Lock the table top.

6.10.2 Suspension table with changeable table leg



Fig. 87 Suspension table

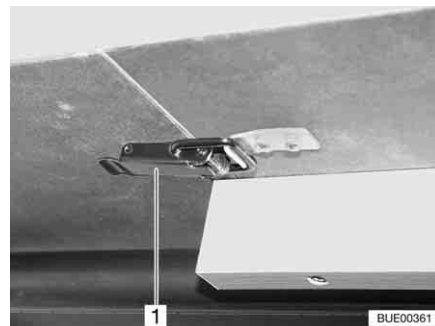

Fig. 88 Catch

The suspension table size can be enlarged by inserting a table-top extension.

- Extending:*
- Open catches (Fig. 88,1).
 - Raise the table-top (Fig. 87,2) slightly and pull it out as far as possible.
 - Set down the table.
 - Insert the table-top extension (Fig. 87,1) and secure it with the catch (Fig. 88,1).
 - Lift the table-top slightly and push back as far as possible.
 - Secure the table-top with the catches.

- Reducing size:*
- Open catches (Fig. 88,1).
 - Slightly lift the front of the table-top and pull out.
 - Remove table-top extension (Fig. 87,1) and lay it aside.
 - Lift the table-top slightly and push back as far as possible.
 - Set down the table.
 - Secure the table-top with the catches.



- ▷ The extension frame beneath the table-top is locked into the mounting rail. Release the lock before lifting the table-top.



Fig. 89 Conversion to bed

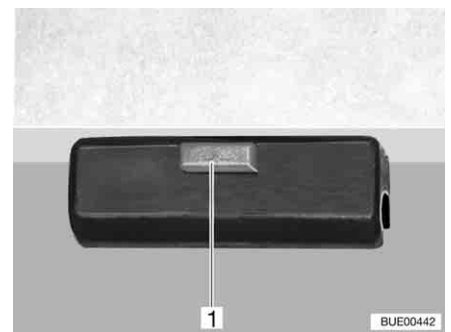

Fig. 90 Lock

- Conversion to bed foundation:*
- Slightly raise the front of the table-top (Fig. 89,2).
 - Remove table leg (Fig. 89,3) and lay it aside.
 - Press the release knob (Fig. 90,1) on the lock (Fig. 89,1).
 - Push the table-top approx. 45° upward and remove it.
 - Bolt on the short table leg.
 - Place the table-top in the holders (Fig. 89,4) on the bench seats.

6.10.3 Suspension table with changeable table leg (without table-top extension)



Fig. 91 Suspension table with changeable table leg

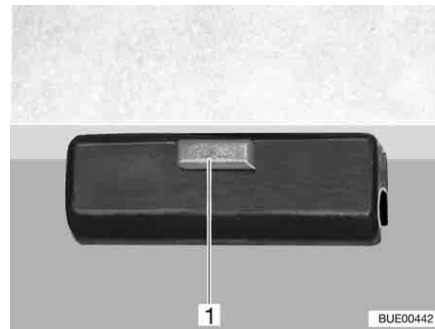

Fig. 92 Lock

The suspension table may also be used as a bed foundation.

Conversion to bed foundation:

- Slightly raise the front of the table-top (Fig. 91,2).
- Remove table leg (Fig. 91,3) and lay it aside.
- Press the release knob (Fig. 92,1) on the lock (Fig. 91,1).
- Push the table-top approx. 45° upward and remove it.
- Bolt on the short table leg.
- Place the table-top in the holders (Fig. 91,4) on the bench seats.

6.10.4 Lift-off table



- ▶ Before commencing the journey, lower the table-top for safety reasons.



Fig. 93 Lift-off table

The top of the lift-off table can be moved both lengthways and crossways.

Moving in a lengthways direction:

- Undo the knurled screw (Fig. 93,5).
- Move the table-top (Fig. 93,1) to the desired position.
- Retighten the knurled screw.

Moving in a crossways direction:

- Undo the knurled screw (Fig. 93,3).
- Move the table-top (Fig. 93,1) to the desired position.
- Retighten the knurled screw.



- ▷ The table-top can only be completely lowered if the cushions have first been removed from the benches or if the table-top has been moved completely to the right and forward.

The lift-off table's lifting mechanism permits it to be used as a bed foundation.

Conversion to bed foundation:

- Swivel the lever (Fig. 93,2) under the table top (Fig. 93,1) by 180° to the left. The lifting mechanism in the table leg (Fig. 93,4) is unlocked.
- Press the table-top in the middle down to the stop limit and hold it down.
- Swivel back the lever by 180° to the right. The table-top remains in the lowest position.

Move the table-top upwards:

- Swivel the lever (Fig. 93,2) under the table top (Fig. 93,1) by 180° to the left. The table-top moves upwards to the limit stop.
- Swivel back the lever by 180° to the right. The table-top remains in the uppermost position.

6.10.5 Fixed table (extendable table-top)

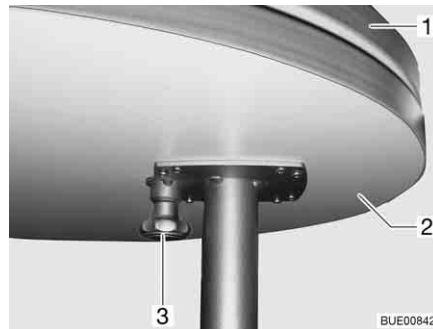

Fig. 94 Fixed table

Extending:

- Pull the knob (Fig. 94,3) of the lock down and swing out the table-top extension (Fig. 94,2).

Reducing size:

- Swing the table-top extension (Fig. 94,2) under the table-top (Fig. 94,1) until the lock latches in place audibly.

The fixed table cannot be used as a bed foundation.

6.10.6 Fixed table (movable table-top)

The top of the fixed table can be moved both lengthways and crossways.

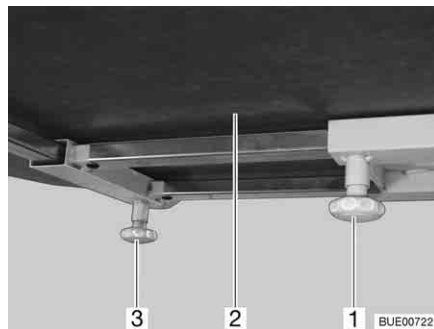

Fig. 95 Fixed table

Moving in a lengthways direction:

- Loosen knurled screw (Fig. 95,1).
- Move table-top (Fig. 95,2) to the desired position.
- Retighten the knurled screw.

Moving in a crossways direction:

- Loosen knurled screw (Fig. 95,3).
- Move table-top (Fig. 95,2) to the desired position.
- Retighten the knurled screw.

The fixed table cannot be used as a bed foundation.

6.10.7 Fixed table (table-top for folding, sliding and rotating)



- ▷ Pull out the support frame before folding down the table-top. The hinges could otherwise be damaged.

The foldable table-top can be rotated and moved crossways.

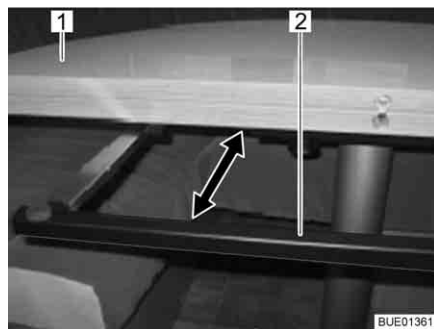

Fig. 96 Support frame

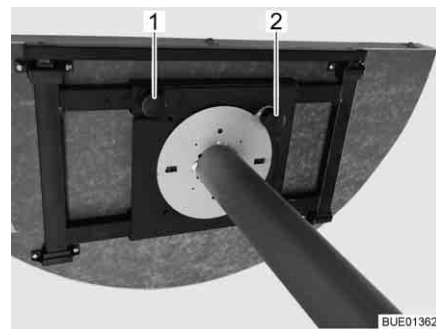

Fig. 97 Fixed table (from below)

Folding out the table top:

- Pull out the support frame (Fig. 96,2) below the table top (Fig. 96,1) to the end position.
- Fold out the table top and carefully rest it on the support frame.

Folding away the table top:

- Lift up the part of the table top that is folded out and place it carefully on the fixed part of the table top.
- Push in the support frame to the end position underneath the table top.

- Moving the table-top:*
- Loosen knurled screw (Fig. 97,1).
 - Move table-top to the desired position.
 - Retighten the knurled screw.

- Rotating table-top:*
- Raise the (Fig. 97,2) adjustment knob.
 - Rotate the table-top into the desired position (in 90° stages).
 - Allow the adjustment knob to click back into position.

6.11 Divan adjustment mechanism (special equipment)

The "Reliner[®]" mechanism allows you to adjust the seat, the neck cushion and the armrest of the divan.



Fig. 98 Adjusting the divan

- Adjusting the seat:*
- Pull up the loop (Fig. 98,2) and carefully pull the seat (Fig. 98,3) along the rails as far as it will go towards the middle.
 - Let go of the loop and move the seat back and forth slightly until you hear it lock into place.
- Adjusting the neck cushion:*
- Hold the neck cushion (Fig. 98,4) in both hands and carefully move it up or down to the right position.
- Adjusting the armrest:*
- Hold the armrest (Fig. 98,1) in both hands and carefully move it up or down to the right position.

6.12 Beds

6.12.1 Fixed bed (gas-pressure springs)



Fig. 99 Fixed bed

A storage compartment is underneath the bed. Lift up the slatted frame to place items in the storage compartment or to empty it from the inside of the vehicle.

- Opening:*
- Lift the mattress forwards and set it down on the panel.
 - Lift slatted frame. The gas-pressure springs (Fig. 99,1) hold the slatted frame open.

- Closing:*
- Press the slatted frame downwards against the resistance of the gas-pressure springs.
 - If necessary, push the mattress behind the panel.

6.12.2 Fixed bed (adjustable head section)



- ▶ Do not let the slatted frame fall down when closing the bed!



Fig. 100 Adjustable head section

Depending on the configuration, the head section of the slatted frame can be adjusted in several stages.

- Raising the head section:*
- Raise the head section (Fig. 100,2) of the slatted frame to the desired position. The support (Fig. 100,1) locks automatically into place.

The head section remains locked in the required position.

- Lowering the head section:*
- Raise the head section (Fig. 100,2) of the slatted frame until the lock is released.
 - Guide the head section downwards slowly.

6.12.3 Fixed bed, electrically adjustable



Fig. 101 Fixed bed, pulled out



Fig. 102 Fixed bed, retracted

The fixed bed (Fig. 101) can be adjusted in length via a manual control unit. This simplifies passage around the bed. When the foot section of the bed is shortened, the head sections are positioned at the same time (Fig. 102).

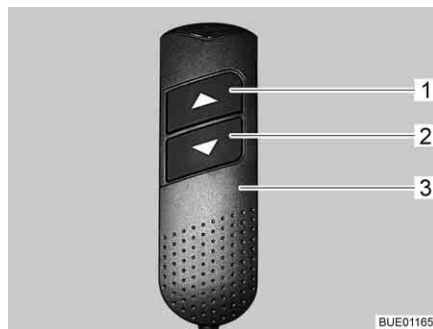

Fig. 103 Manual control unit

- Retracting:*
- On the manual control unit (Fig. 103,3) push the "▼" button (Fig. 103,2) and keep it pressed. The foot section is retracted. The head sections are raised.
- Extending:*
- On the manual control unit (Fig. 103,3) push the "▲" button (Fig. 103,1) and keep it pressed. The foot section is extended. The head sections are lowered.
- Adjusting the head sections:*
- On the manual control unit (Fig. 103,3), press the "▼" button (Fig. 103,2) or "▲" button (Fig. 103,1) until the desired position is reached.

The head sections remain in the desired position.

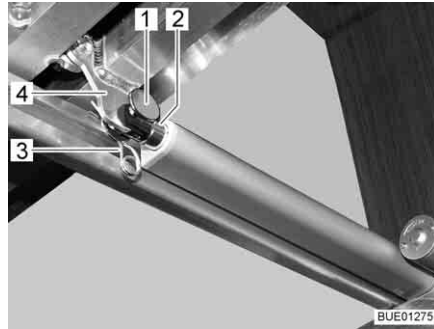

Fig. 104 Drive

Emergency operation

Proceed as follows if the bed can no longer be adjusted via the manual control unit:

- Remove the connection (e.g. pin and cotter pin (Fig. 104,1 and 3)) between the push rod (Fig. 104,2) and the slatted frame (Fig. 104,4).
- Slowly push the slatted frame all the way forward. When doing this, hold onto the head sections of the slatted frames.
- Contact customer service.

6.12.4 Bunk bed

- ▶ Only use the upper bunk bed if the safety guard is fitted.
- ▶ The maximum permitted bunk bed load is 100 kg.
- ▶ The upper bunk bed must not be used by children under 6 years of age.
- ▶ Never allow small children to remain in the bunk bed without supervision.
- ▶ But in particular with regard to small children less than 6 years of age, users should ensure that they cannot fall out of the bunk bed.
- ▶ Use separate children's beds or travel cots suitable for children.

Depending on the model, the vehicle is fitted with a bunk bed. The bunk bed can be used immediately, without additional conversion.

Always use the access ladder provided to climb up to the top bed.

6.12.5 Pull-down bed, manually operated (Ixeo)

- ▶ Switch off the reading lamps in the pull-down bed before the bed is pushed up. Fire hazard!
- ▶ Switch off the reading lamps on the underside of the pull-down bed when the bed is lowered. Fire hazard!
- ▶ The maximum permitted pull-down bed load is 200 kg.
- ▶ Before commencing the journey, secure the pull-down bed. To do this, lock the pull-down bed.
- ▶ Before use, pull the pull-down bed into the lower end position. Ensure that the pull-down bed is not resting on obstacles such as headrests or similar.
- ▶ Only use the pull-down bed, if the safety net is set up.
- ▶ Never allow small children to remain in the pull-down bed without supervision.



- ▶ But in particular with regard to small children less than 6 years of age, users should ensure that they cannot fall out of the pull-down bed.
- ▶ Use separate children's beds or travel cots suitable for children.



- ▷ You must be able to close the pull-down bed without any great effort, so that there is no tension in the locking position. Objects on the pull-down bed can distort the lifting mechanism on one side, resulting in damage.

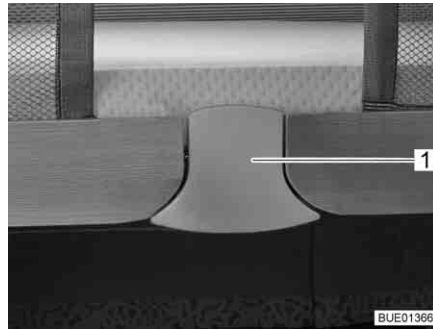

Fig. 105 Release

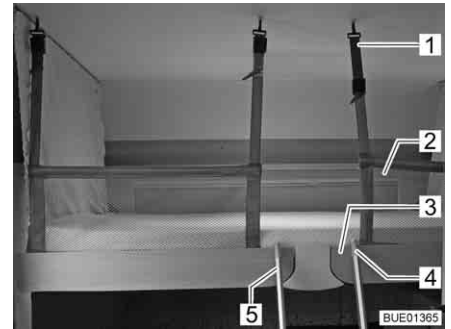

Fig. 106 Pull-down bed complete with applied safety net

The pull-down bed is located above the front seating group.

The pull-down bed has two locking positions in the uppermost position. The pull-down bed is securely locked in both locking positions.

Opening the pull-down bed:

- Remove obstacles from the space into which the pull-down bed extends (e. g. push the seats forward and rotate, remove or move cushions).
- Switch off the lamps underneath the pull-down bed.
- Pull out the release area (Fig. 105,1) at the bottom. The lock is released.
- With both hands, pull the pull-down bed down as far as it will go.
- If the pull-down bed was in the uppermost locking position: pull the release area out again to override the second locking position. With both hands, pull the pull-down bed down as far as it will go.
- Make sure that the pull-down bed is in the lower end position and is not resting on obstacles such as headrests or cushions.



- ▷ When closing the pull-down bed, pull the side fabric panels inwards. This prevents the fabric from getting trapped in the lock of the pull-down bed.

Closing the pull-down bed:

- Switch off the reading lamps in the pull-down bed.
- Using both hands, push the pull-down bed upwards as far as the first locking position. If necessary, push the pull-down bed further upwards as far as the uppermost locking position. When doing this, ensure that the snap latch engages audibly in the locking bracket.
- Check that the pull-down bed is locked correctly. To do this, pull down the pull-down bed firmly.

Safety net

The safety net (Fig. 106,2) and the retaining belts are located underneath the mattress in the pull-down bed. Only use the safety net if persons are already in the pull-down bed.

Setting up:

- Attach the retaining belts (Fig. 106,1) to the hooks on the ceiling.

Access ladder Always use the provided access ladder (Fig. 106,5) to climb up to the pull-down bed.

Attaching: ■ Hook access ladder (Fig. 106,5) to the pull-down bed by attaching the two hooks (Fig. 106,4) in the holding bar (Fig. 106,3).

Storing away: ■ Hang the access ladder (Fig. 106,5) from the holding bar (Fig. 106,3) on the pull-down bed.
■ Store the access ladder securely.

6.12.6 Pull-down bed, electrically operated (special equipment, Ixeo)



- ▶ Switch off the reading lamps in the pull-down bed before the bed is pushed up. Fire hazard!
- ▶ Switch off the reading lamps on the underside of the pull-down bed when the bed is lowered. Fire hazard!
- ▶ The maximum permitted pull-down bed load is 200 kg.
- ▶ Do not reach into the area between the bed and the side wall when lowering or raising. Danger of bruises!
- ▶ Do not lower or lift the bed when there are people using the pull-down bed.
- ▶ Only lower the bed if the lowering area is clear.
- ▶ Bring the pull-down bed into the lower end position before use. Ensure that the pull-down bed is not resting on obstacles such as headrests or similar.
- ▶ Do not allow children to play with the pull-down bed.
- ▶ Store the remote control in a safe place inaccessible to children.
- ▶ Only use the pull-down bed, if the safety net is set up.
- ▶ Use separate children's beds or travel cots suitable for children.
- ▶ Never allow small children to remain in the pull-down bed without supervision.
- ▶ But in particular with regard to small children less than 6 years of age, users should ensure that they cannot fall out of the pull-down bed.



- ▷ Only raise or lower the pull-down bed if it is loaded with a maximum of 15 kg. This maximum load includes the contents of the wall-mounted cupboard at the base of the pull-down bed. If the pull-down bed is overloaded, the overload protection switches off the lifting motor. However, the lifting mechanism can still be damaged.
- ▷ Before starting a journey, the pull-down bed must be brought into the uppermost end position. No objects must be stuck between the roof and the pull-down bed.



Fig. 107 Manual control unit

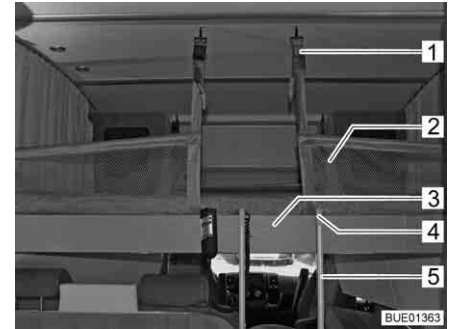

Fig. 108 Pull-down bed complete with applied safety net



► When making ready for operation, overload protection is not in use.

Making ready for operation

After every power interruption (e.g. lay-up over winter), the electrical drive must be made ready for operation again. To do so carry out a reference run.

Carrying out a reference run:

- Using the arrow key (Fig. 107,3) on the manual control unit, bring the pull-down bed down as far as it will go or into any intermediate position.
- Press the "R" (Fig. 107,2) key three times in a row.
- Within 10 seconds, bring the pull-down bed upwards using the arrow key (Fig. 107,4).
- When the end position is reached, a beeping noise is emitted. Release the arrow key.

Opening the pull-down bed:

- Remove obstacles from the space into which the pull-down bed extends (e.g. push the seats forward and rotate, remove or move cushions).
- Switch off the lamps underneath the pull-down bed.
- On the manual control unit (Fig. 107,1), press the arrow key (Fig. 107,3) and keep it pressed until the pull-down bed has moved downwards to its end position.
- Make sure that the pull-down bed is in the lower end position and is not resting on obstacles such as headrests or cushions.

Closing the pull-down bed:

- Switch off the reading lamps in the pull-down bed.
- On the manual control unit (Fig. 107,1), press the arrow key (Fig. 107,4) and keep it pressed until the pull-down bed has moved up into its end position.
- Ensure that there are no objects stuck between the roof and the pull-down bed

Overload protection

If the pull-down bed meets an obstacle during opening or closing (e.g. a person or a headrest), the overload protection stops the movement. For release, move the pull-down bed with the arrow key in the opposite direction.

Safety net

The safety net (Fig. 108,2) and the retaining belts are located underneath the mattress in the pull-down bed. Only use the safety net if persons are already in the pull-down bed.

Setting up:

- Attach the retaining belts (Fig. 108,1) to the hooks on the ceiling.

Access ladder Always use the provided access ladder to climb up to the pull-down bed.

Attaching:

- Hook access ladder (Fig. 108,5) to the pull-down bed by attaching the two hooks (Fig. 108,4) in the holding bar (Fig. 108,3).

Storing away:

- Hang the access ladder (Fig. 108,5) from the holding bar (Fig. 108,3) on the pull-down bed.
- Store the access ladder securely.

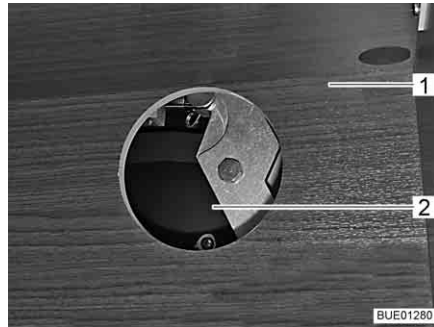

Fig. 109 Access to drive

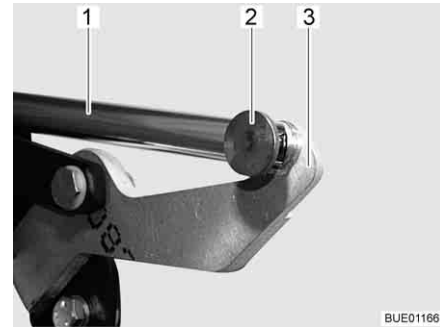

Fig. 110 Drive

Emergency operation If the pull-down bed can no longer be moved via the manual control unit (e.g. due to loss of the vehicle's power supply), it can also be operated manually. To do this, proceed as follows:

- Depending on the model, open the flap of the wall-mounted cupboard (Fig. 109,1) and remove the cover from the access port (Fig. 109,2).
- Detach the pin and cotter pin (Fig. 110,2) between the push rod (Fig. 110,1) and lever (Fig. 110,3).
- Open or close the pull-down bed manually.
- Contact customer service.

6.12.7 Step, foldable



- ▶ Stand on the step only when the step is securely positioned.

Depending on the model, the vehicle has a folding step. The step is secured in a separate storage compartment in front of the rear bed.



Fig. 111 Step, folded out



Fig. 112 Lock

- Opening:*
- Open the door (Fig. 111,1) of the storage compartment.
 - Unlock the step (Fig. 112,1).
 - Completely fold out the step (Fig. 111,2). The supporting bracket (Fig. 111,3) must face perpendicularly down and rest firmly on the floor.
- Closing:*
- Fold in step (Fig. 111,2).
 - Lock the step (Fig. 112,1).
 - Close and lock the door (Fig. 111,1) of the storage compartment.

6.12.8 Widening single beds (special equipment)

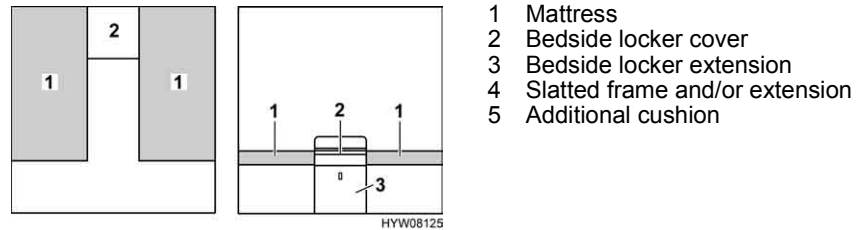

Fig. 113 Prior to conversion

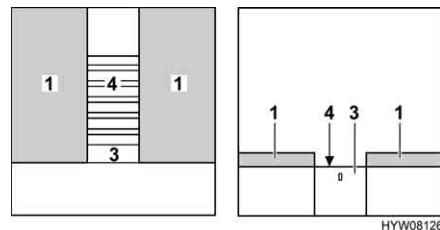

Fig. 114 During conversion

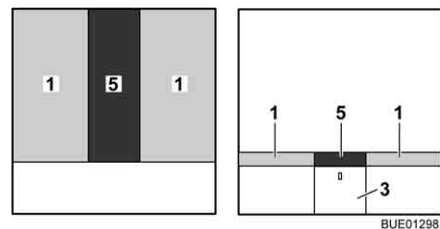

Fig. 115 After conversion

- Remove the bedside locker cover (Fig. 113,2) and put it to one side.
- If a locking mechanism is attached to the extension (Fig. 114,3): Reach behind the surround and unlock the extension.
- Pull out the slatted frame (Fig. 114,4) and/or the extension as far as it will go.
- Place the additional cushion (Fig. 115,5) between the mattresses (Fig. 115,1).

6.13 Converting seating groups for sleeping

The seating groups installed in the vehicles can be divided into three categories:

- Individual bench seats that can be converted into an emergency bed.
- Seating groups with a lateral individual seat or lateral bench seat, which can be converted into a transverse bed.
- Seating groups with bed widening, which can be converted into a length-wise bed.

The following table gives an overview of the seating groups installed in the different models and names the section in which the bed conversion is described.



- ▷ The ground plans for the individual models are shown in chapter 16.

Model	Seating group	Table type	Bed	Section
T 569	Individual bench	Suspension table with rotating platform	Guest bed	6.13.1
T 571	Individual bench with lateral seat	Suspension table with extension	Transverse bed	6.13.6
T 580	Individual bench with lateral seat (vario seat)	Lift-off table	Transverse bed	6.13.3
T 615	L-seating group with lateral bench seat	Lift-off table	Transverse bed	6.13.8
T 620	Individual bench with lateral seat	Suspension table with extension	Transverse bed	6.13.6
T 660	Individual bench with lateral bench seat	Suspension table with rotating platform	Transverse bed	6.13.5
T 660	L-seating group with lateral bench seat	Lift-off table	Transverse bed	6.13.8
T 687	Individual bench with lateral seat	Suspension table with rotating platform	Guest bed	6.13.1
T 687	L-seating group with individual seat	Lift-off table	Guest bed	6.13.1
T 715	Individual bench with lateral bench seat	Suspension table with rotating platform	Transverse bed	6.13.5
T 715	L-seating group with lateral bench seat	Lift-off table	Transverse bed	6.13.8
T 720	Individual bench with lateral seat	Suspension table with rotating platform	Transverse bed	6.13.5
T 720	L-seating group with lateral seat	Lift-off table	Transverse bed	6.13.8
T 727	L-seating group with lateral seat	Lift-off table	Transverse bed	6.13.9
T 728	Individual bench with lateral seat	Suspension table with rotating platform	Transverse bed	6.13.6
T 728	L-seating group with lateral seat	Lift-off table	Transverse bed	6.13.9
T 729	L-seating group with lateral seat	Lift-off table	Transverse bed	6.13.9
T 736	L-seating group with lateral bench seat	Lift-off table	Transverse bed	6.13.10
T 740	Individual bench with lateral seat	Suspension table with rotating platform	Transverse bed	6.13.6
T 740	L-seating group with lateral seat	Lift-off table	Transverse bed	6.13.12

Model	Seating group	Table type	Bed	Section
IT 585	L-seating group with lateral bench seat	Lift-off table	Transverse bed	6.13.10
IT 630	Individual bench	Suspension table with rotating platform	Guest bed	6.13.1
IT 650	Facing seating unit	Suspension table	Lengthwise bed with bed widening	6.13.2
IT 660	Facing seating unit	Suspension table	Lengthwise bed with bed widening	6.13.2
IT 664	Individual bench with lateral bench seat	Suspension table with rotating platform	Transverse bed	6.13.4
IT 670	Individual bench	Suspension table with rotating platform	Guest bed	6.13.1
IT 700	L-seating group with lateral bench seat	Fixed table	-	-
IT 710	Individual bench with lateral bench seat	Suspension table with rotating platform	Transverse bed	6.13.4
IT 710	L-seating group with lateral bench seat	Lift-off table	Transverse bed	6.13.7
IT 720	Individual bench with lateral bench seat	Suspension table with rotating platform	Guest bed	6.13.1
IT 720	L-seating group with lateral bench seat	Lift-off table	Transverse bed	6.13.4
IT 724	Individual bench with lateral bench seat	Suspension table with rotating platform	Transverse bed	6.13.4
IT 726	Individual bench with lateral bench seat	Suspension table with rotating platform	Transverse bed	6.13.4
IT 728	L-seating group with lateral bench seat	Lift-off table	Transverse bed	6.13.12
IT 734	Individual bench with lateral bench seat	Suspension table with rotating platform	Transverse bed	6.13.6
IT 734	L-seating group with lateral seat	Lift-off table	Transverse bed	6.13.8
IT 735	Individual bench with lateral bench seat	Suspension table with rotating platform	Transverse bed	6.13.6

Model	Seating group	Table type	Bed	Section
IT 735	L-seating group with lateral seat	Lift-off table	Transverse bed	6.13.8
IT 740	Individual bench with lateral bench seat	Suspension table with rotating platform	Transverse bed	6.13.4
IT 875	L-seating group with lateral bench seat	Lift-off table	Transverse bed	6.13.12

6.13.1 Small central seating group

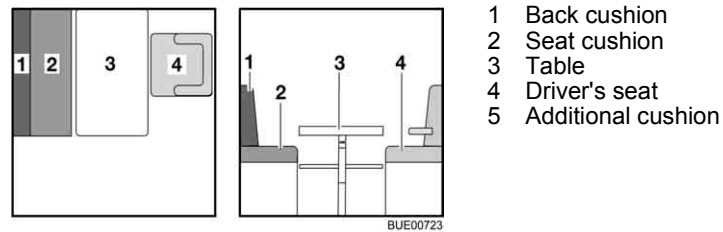

Fig. 116 Prior to conversion

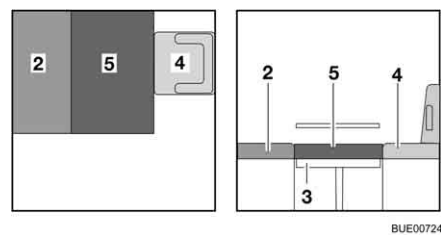

Fig. 117 After conversion

- Turn the driver's seat (Fig. 116,4) and push it all the way forward.
- Convert the table (Fig. 116,3) to a bed foundation (see section 6.10).
- Lay the back cushion (Fig. 116,1) aside.
- Place the additional cushion (Fig. 117,5) on the table.
- If required, push the driver's seat (Fig. 117,4) back to the rear.

6.13.2 Central seating group with bed widening

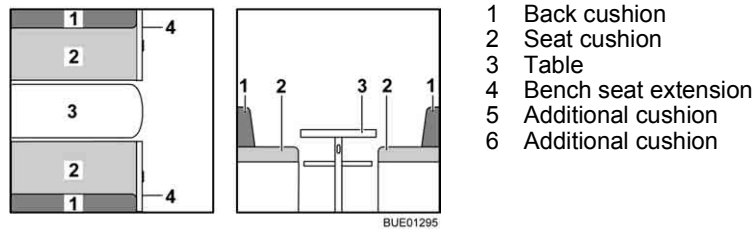

Fig. 118 Prior to conversion

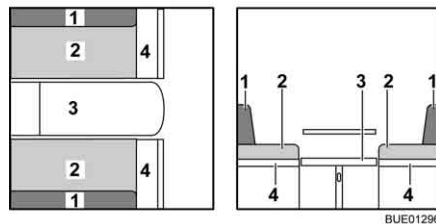

Fig. 119 During conversion

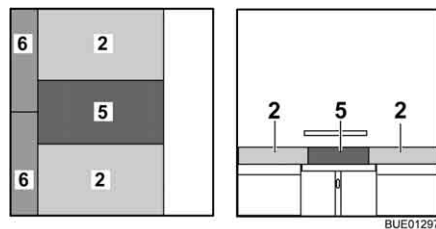
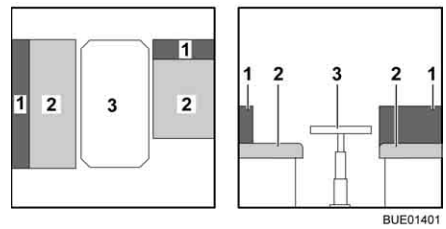

Fig. 120 After conversion

- Extend the table (Fig. 118,3) and convert it into a bed foundation (see section 6.10).
- Widen bench seat (Fig. 119,4).
- Remove the back cushions (Fig. 119,1) and lay them aside.
- Pull the seat cushions (Fig. 119,2) into the centre.
- Insert the additional cushion (Fig. 120,5) onto the table between the seat cushions.
- Insert the additional cushions (Fig. 120,6) between the seat cushions and the wall.

6.13.3 Seating group with vario seat



- 1 Back cushion
- 2 Seat cushion
- 3 Table
- 4 Seat extension
- 5 Additional cushion 1
- 6 Additional cushion 2

Fig. 121 Prior to conversion

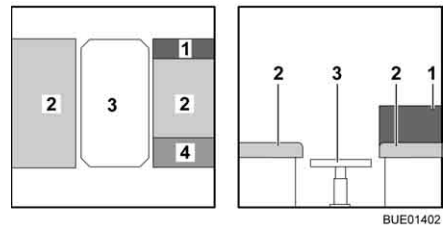

Fig. 122 During conversion

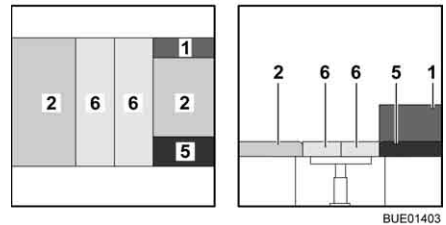

Fig. 123 After conversion

- Convert the table (Fig. 121,3) to a bed foundation (see section 6.10).
- Pull out seat extension (Fig. 122,4).
- Place the additional cushion 1 (Fig. 123,5) on the seat extension.
- Place two additional cushions (Fig. 123,6) on the table.

6.13.4 Central bench with divan

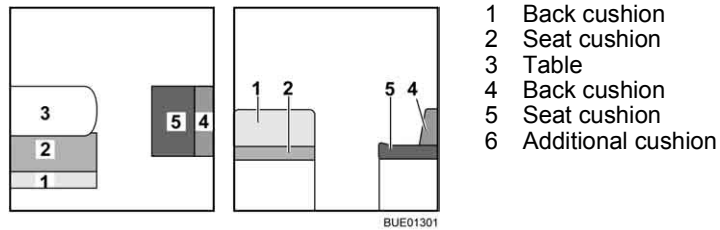

Fig. 124 Prior to conversion

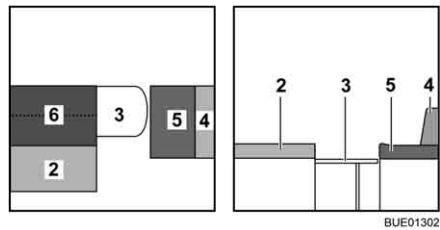

Fig. 125 During conversion

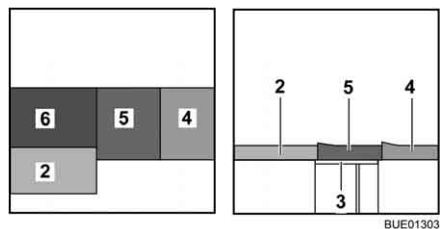

Fig. 126 After conversion

- Convert the table (Fig. 124,3) to a bed foundation (see section 6.10).
- Remove the back cushion (Fig. 124,1) and lay it aside.
- Unfold the additional cushion (Fig. 125,6) and lay it on the table.
- Place the seat cushion (Fig. 126,5) in the centre.
- Place the back cushion (Fig. 126,4) between the seat cushion and the wall.

6.13.5 Central bench with divan (with bed widening)

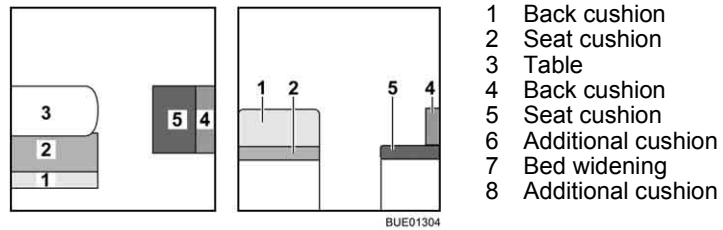

Fig. 127 Prior to conversion

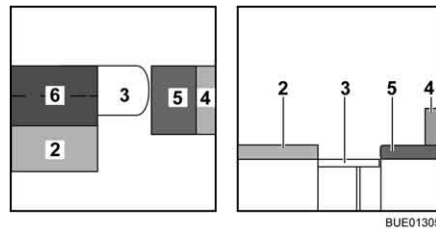

Fig. 128 During conversion

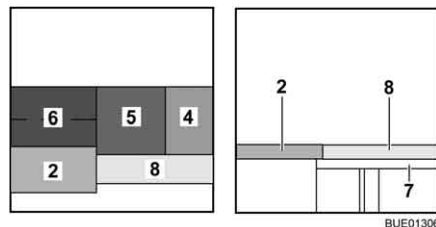

Fig. 129 After conversion

- Convert the table (Fig. 127,3) to a bed foundation (see section 6.10).
- Remove the back cushion (Fig. 127,1) and lay it aside.
- Unfold the additional cushion (Fig. 128,6) and lay it on the table.
- Place the seat cushion (Fig. 129,5) in the centre.
- Place the back cushion (Fig. 129,4) between the seat cushion and the wall.
- Hook the bed widening (Fig. 129,7) into the recesses on the bench seats.
- Place the additional cushion (Fig. 129,8) on the bed widening.

6.13.6 Central bench with divan (Van)

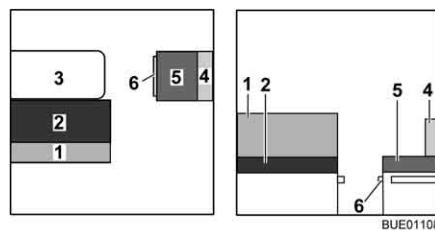

Fig. 130 Prior to conversion

- 1 Back cushion
- 2 Seat cushion
- 3 Table
- 4 Back cushion
- 5 Seat cushion
- 6 Bedding box extension
- 7 Additional cushion (foldable)
- 8 Seat base extension
- 9 Bed widening
- 10 Additional cushion

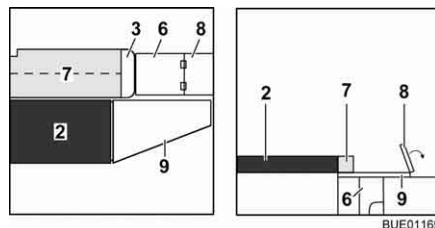

Fig. 131 During conversion

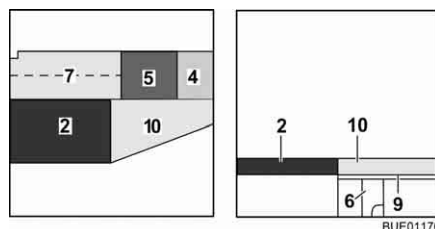

Fig. 132 After conversion

- Convert the table (Fig. 130,3) to a bed foundation (see section 6.10).
- Remove the back cushion (Fig. 130,1) and lay it aside.



- ▷ Depending on the model, the back cushion (Fig. 130,1) can be used instead of the additional cushion (Fig. 131,7).

- Remove the back cushion (Fig. 130,4) and the seat cushion (Fig. 130,5) and lay them aside.
- Pull out the bedding box extension (Fig. 131,6).
- Fold the seat base extension (Fig. 131,8) outwards.
- Unfold the additional cushion (Fig. 131,7) and lay it on the table.
- Place the seat cushion (Fig. 132,5) in the centre.
- Place the back cushion (Fig. 132,4) between the seat cushion and the wall.
- Hook the bed widening (Fig. 131,9) into the recesses on the bench seats.
- Place the additional cushion (Fig. 132,10) on the bed widening.

6.13.7 L-shaped bench with divan

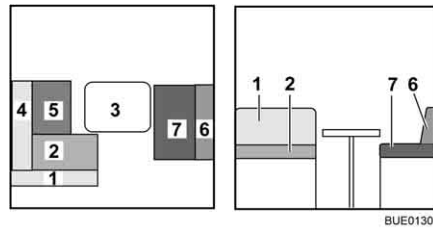

- 1 Back cushion
- 2 Seat cushion
- 3 Table
- 4 Back cushion
- 5 Seat cushion
- 6 Back cushion
- 7 Seat cushion
- 8 Additional cushion

Fig. 133 Prior to conversion

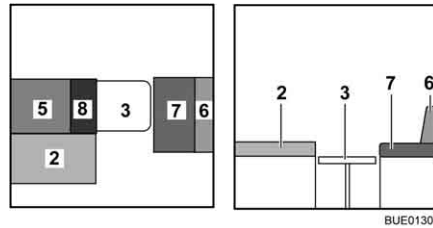

Fig. 134 During conversion

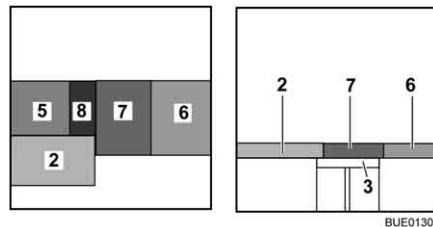

Fig. 135 After conversion

- Convert the table (Fig. 133,3) to a bed foundation (see section 6.10).
- Remove the back cushions (Fig. 133,1 and 4) and lay them aside.
- Place the additional cushion (Fig. 134,8) on the table.
- Place the seat cushion (Fig. 135,7) in the centre.
- Place the back cushion (Fig. 135,6) between the seat cushion and the wall.

6.13.8 L-shaped bench with divan (with bed widening)

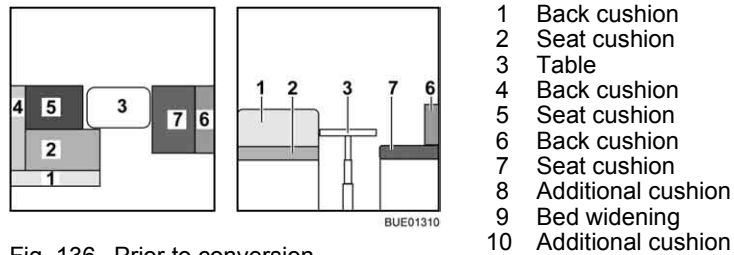

Fig. 136 Prior to conversion

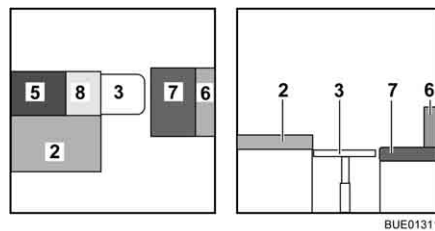

Fig. 137 During conversion

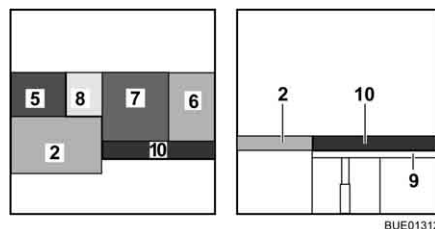

Fig. 138 After conversion

- Convert the table (Fig. 136,3) to a bed foundation (see section 6.10).
- Remove the back cushions (Fig. 136,1 and 4) and lay them aside.
- Place the additional cushion (Fig. 137,8) on the table.
- Place the seat cushion (Fig. 137,7) in the centre.
- Place the back cushion (Fig. 137,6) between the seat cushion and the wall.
- Hook the bed widening (Fig. 138,9) into the recesses on the bench seats.
- Place the additional cushion (Fig. 138,10) on the bed widening.

6.13.9 L-shaped bench with lengthwise seat (with additional cushion)

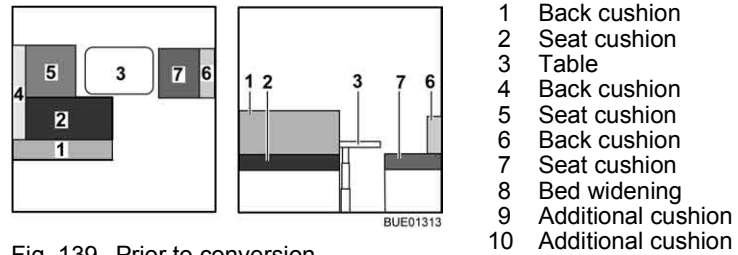

Fig. 139 Prior to conversion

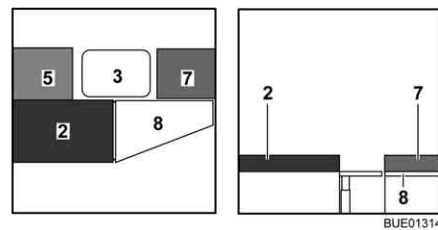

Fig. 140 During conversion

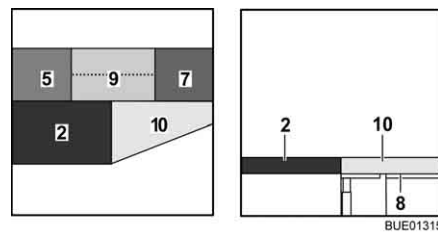

Fig. 141 After conversion

- Convert the table (Fig. 139,3) to a bed foundation (see section 6.10).
- Remove the back cushions (Fig. 139,1, 4 and 6) and lay them aside.
- Hook the bed widening (Fig. 140,8) into the recesses on the bench seats.
- Unfold the additional cushion (Fig. 141,9) and lay it on the table.
- Place the additional cushion (Fig. 141,10) on the bed widening.

6.13.10 L-shaped bench (long) with divan

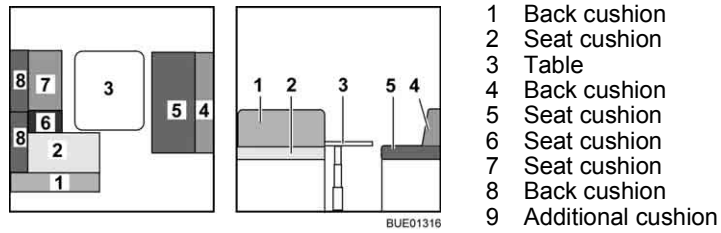

Fig. 142 Prior to conversion

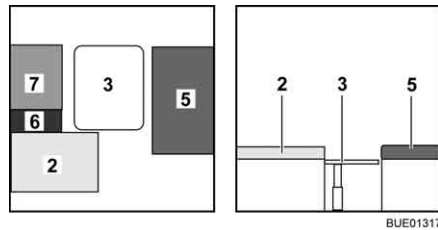

Fig. 143 During conversion

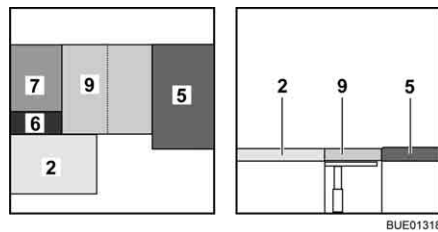

Fig. 144 After conversion

- Convert the table (Fig. 142,3) to a bed foundation (see section 6.10).
- Remove the back cushions (Fig. 142,1, 4 and 8) and lay them aside.
- Unfold the additional cushion (Fig. 144,9) and lay it on the table.

6.13.11 L-shaped bench (long) with divan (wide)

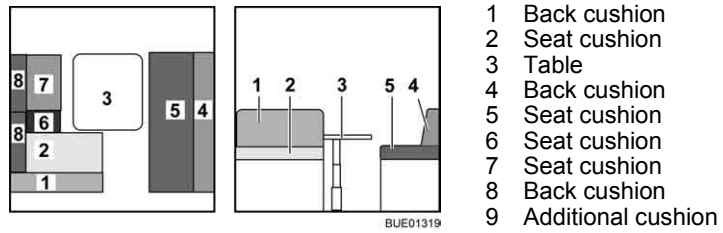

Fig. 145 Prior to conversion

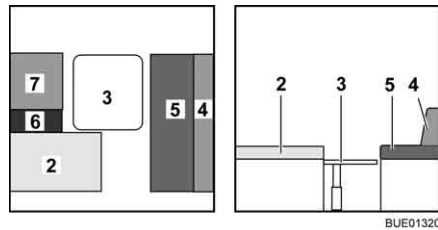

Fig. 146 During conversion

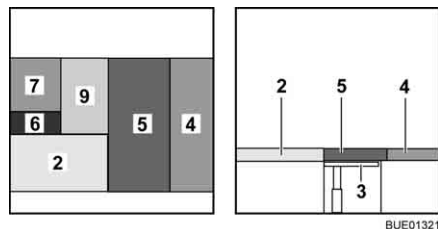

Fig. 147 After conversion

- Convert the table (Fig. 145,3) to a bed foundation (see section 6.10).
- Remove the back cushions (Fig. 145,1 and 8) and lay them aside.
- Unfold the additional cushion (Fig. 147,9) and lay it on the table.
- Place the seat cushion (Fig. 147,5) in the centre.
- Place the back cushion (Fig. 147,4) between the seat cushion and the wall.

6.13.12 L-shaped bench with divan

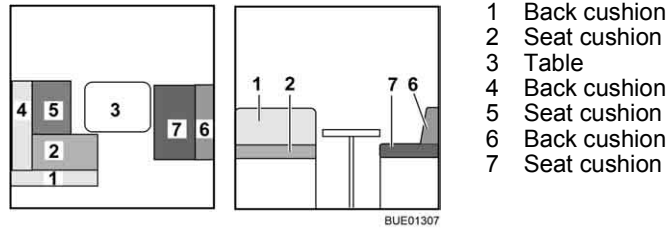

Fig. 148 Prior to conversion

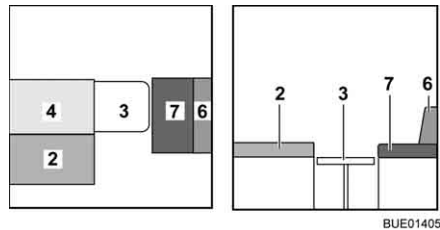

Fig. 149 During conversion

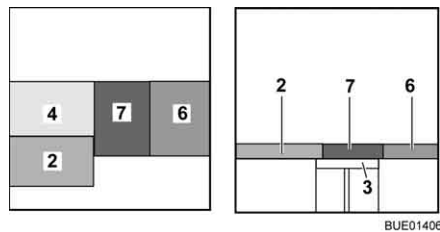

Fig. 150 After conversion

- Convert the table (Fig. 148,3) to a bed foundation (see section 6.10).
- Remove the back cushion (Fig. 148,1) and lay it aside.
- Place the back cushion (Fig. 149,4) next to the seat cushion (Fig. 149,2).
- Place the seat cushion (Fig. 150,7) in the centre.
- Place the back cushion (Fig. 150,6) between the seat cushion and the wall.

Chapter overview

This chapter contains instructions regarding the gas system of the vehicle. The instructions address the following topics:

- safety
- changing the gas bottles
- gas isolator taps
- external gas connection
- automatic switching facility
- the gas alarm system

The operation of the gas operation appliances of the vehicle is described in chapter 9.

7.1 General



- ▶ Before commencing the journey, when leaving the vehicle or when gas equipment is not in use, close all gas isolator taps and the main isolator tap on the gas bottle.
- ▶ No appliance operated by a naked flame (e.g. heater or refrigerator) may be in operation when filling the tank, on ferries or in the garage. Danger of explosion!
- ▶ Do not use appliances operated with a naked flame in closed spaces (e.g. garages). Danger of poisoning and suffocation!
- ▶ Only have the gas system maintained, repaired or altered by an authorised specialist workshop.
- ▶ Have the gas system checked by an authorised specialist workshop according to the national regulations before commissioning. This also applies for not registered vehicles. For modifications to the gas system have the gas system immediately checked by an authorised specialist workshop.
- ▶ The gas pressure regulator and exhaust gas pipes must also be inspected. The gas pressure regulator has to be replaced after 10 years at the latest. The vehicle owner is responsible for seeing that this is carried out.
- ▶ In case of a defect of the gas system (gas odour, high gas consumption) there is danger of explosion! Close regulator tap on the gas bottle immediately. Open doors and windows and ventilate well.
- ▶ If the gas system is defective: Do not smoke; do not ignite any open flames, and do not operate electric switches (light switches etc.).
- ▶ Before using the cooker make sure that there is sufficient ventilation. Open windows or the skylight.
- ▶ Do not use the gas cooker or gas oven for heating purposes.
- ▶ If there are several gas devices, each gas device must have its own gas isolator tap. If individual gas devices are not in use, close the respective gas isolator tap.
- ▶ Ignition safety valves must close within 1 minute after the gas flame has extinguished. A clicking sound is audible. Check function from time to time.
- ▶ The built-in gas devices are exclusively meant for use with propane or butane gas or a mixture of both. The gas pressure regulator as well as all built-in gas devices are designed for a gas pressure of 30 mbar.



- ▶ Propane gas is capable of gasification up to -42 °C , whereas butane gas gasifies at 0 °C . Below these temperatures no gas pressure is available. Butane gas is unsuitable for use in winter.
- ▶ Regularly inspect the gas tube fitted to the gas bottle connection for tightness. The gas tube must not have any tears and must not be porous. Have the gas tube replaced by an authorised specialist workshop no later than ten years after the manufacturing date. The operator of the gas system must see to it that the parts are replaced.
- ▶ Due to its function and construction, the gas bottle compartment is a space which is open to the exterior. Never cover or block up the standard forced ventilations. Otherwise gas that is emitted can not be diverted to the outside.
- ▶ Do not use the gas bottle compartment as storage space as it is not moisture-proof.
- ▶ Secure the gas bottle compartment against unauthorised access. To do this, lock the compartment.
- ▶ The regulator tap on the gas bottle must be accessible.
- ▶ Only connect gas-operated devices (e.g. gas grill) which have been designed for a gas pressure of 30 mbar.
- ▶ The exhaust gas pipe must be fitted tightly to the heating system and to the vent and must be sealed. The exhaust gas pipe must not show any evidence of damage.
- ▶ Exhaust fumes must be able to escape into the atmosphere unhindered and fresh air must be able to enter unhindered. For this reason, keep the exhaust pipe and intake openings clean and unobstructed (e.g. free from snow and ice). For this reason, no snow walls or aprons may lie against the vehicle.

7.2 Gas bottles



- ▶ Gas bottles are only to be transported within the designated gas bottle compartment.
- ▶ Place the gas bottles in vertical position in the gas bottle compartment.
- ▶ Fasten the gas bottles so that they are unable to turn or tilt.
- ▶ If the gas bottles are not connected to the gas tube, always place the protective cap on top.
- ▶ Close the regulator tap on the gas bottle before the gas pressure regulator or gas tube are removed from the gas bottle.
- ▶ Use your hands only to connect the gas pressure regulator or the gas tube to the gas bottles. Do not use any tools.
- ▶ Only use special gas pressure regulators with a safety valve designed for vehicle use. Other gas pressure regulators are not permitted and cannot meet the demanding requirements.
- ▶ Use the gas pressure regulator defroster if the temperature falls below 5 °C .
- ▶ Use only 11 kg or 5 kg gas bottles. Camping gas bottles with built-in check valve (blue bottle with max. 2.5 or 3 kg content) are can be used in exceptional cases with a safety valve.



- ▶ Use the shortest possible tube lengths (150 cm max.) for external gas bottles.
- ▶ Never block the floor ventilation openings below the gas bottles.



- ▷ With some models, the gas bottle compartment is located right next to the conversion door. With these models, only open the gas bottle compartment when the conversion door is closed. Danger from damages.



- ▷ For gas-operated units the gas pressure must be reduced to 30 mbar.
- ▷ Connect gas pressure regulator complete with safety valve directly to bottle valve.

The gas pressure regulator reduces the gas pressure in the gas bottle down to the operating pressure of the gas devices.

- ▷ For filling and connecting the gas bottles in Europe the accessories shops have corresponding Euro filling sets and Euro bottle sets.
- ▷ Information available at the dealers or service centre.
- ▷ For information on the gas supply in Europe see chapter 17.

7.3 Changing gas bottles



- ▶ When changing gas bottles, do not smoke or create any open fire.
- ▶ When you have changed the gas bottle, check whether gas escapes at the connection points and unions. Use a leakage search spray to spray the relevant connection point or union. These agents are available at the accessories shop.

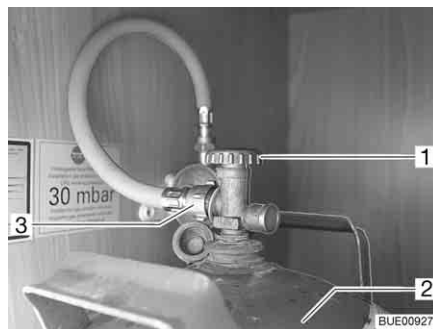
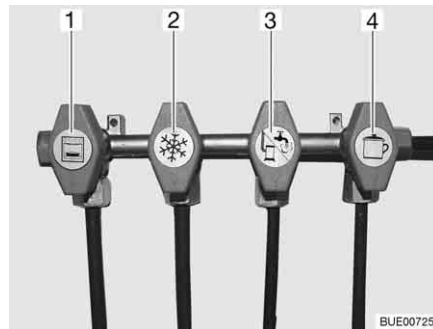

Fig. 151 Gas bottle compartment

- Open external gas bottle compartment (see chapter 6).
- Close the regulator tap (Fig. 151,1) on the gas bottle (Fig. 151,2). Pay attention to the direction of the arrow.
- Unscrew the gas tube (Fig. 151,3) by hand from the gas bottle.
- Release the fixing belts and remove the gas bottle.
- Place a filled gas bottle in the gas bottle compartment.
- Fix gas bottle in place with the fixing belts.
- Screw gas tube on gas bottle by hand.

7.4 Gas isolator taps



- 1 Oven
- 2 Refrigerator
- 3 Heater/boiler
- 4 Cooker

Fig. 152 Symbols for the gas isolator taps

A gas isolator tap (Fig. 152) for every gas device is built into the vehicle. The gas isolator taps are located in the vehicle at different positions, and can also be fitted separately.

7.5 External gas connection (special equipment)



- ▶ If the external gas connection is not in use, always close the gas isolator tap.
- ▶ Only gas appliances with a suitable adapter should be connected to the external gas connection.
- ▶ Connect only external gas appliances which are designed for an operation pressure of 30 mbar.
- ▶ Once you have made the connection and opened the gas isolator tap, make sure that no gas is escaping at the connection point. If there is a leak in the external gas connection, gas will escape into the open air. Immediately close the gas isolator tap and the regulator tap on the gas bottle. Have the external gas connection checked by an authorised specialist workshop.
- ▶ When connecting an external gas appliance, make sure that there is nothing near the external gas connection that could cause a spark.
- ▶ Do not use the external gas connection to fill gas bottles. Observe the information stickers on the external gas connection.

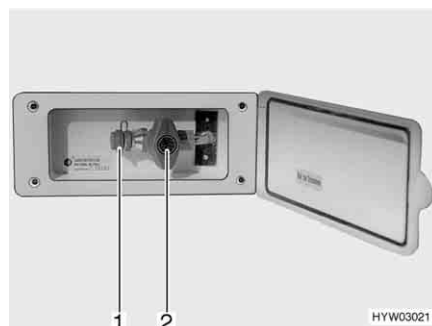

Fig. 153 External gas connection, gas isolator tap closed

The external gas connection (Fig. 153) is located at the rear or to the left or right of the vehicle depending on the model.

- Connect the external gas device to the connection point (Fig. 153,1).
- Open the gas isolator tap (Fig. 153,2).

7.6 Crash protection unit switching facility (special equipment)



▶ Do not use the switching facility in closed spaces.



- ▷ When the vehicle is equipped with the crash protection unit the living area heater may be operated during the journey.
- ▷ If the vehicle is equipped with a panel of the DT series and the switching facility is operated via this panel, the operating unit is redundant.
- ▷ Also read the manufacturer's instruction manual.

The crash protection unit is an automatic switching facility with a control unit for a two-bottle gas system. The switching facility automatically switches gas supply from the primary bottle to the reserve bottle as soon as the primary bottle is either empty or no longer ready for operation. The gas appliances may still continue operation. The switching facility is suitable for all commercial gas bottles from 3 kg to 33 kg. In the event of an accident or a too high angle of the vehicle the gas supply will automatically be interrupted.

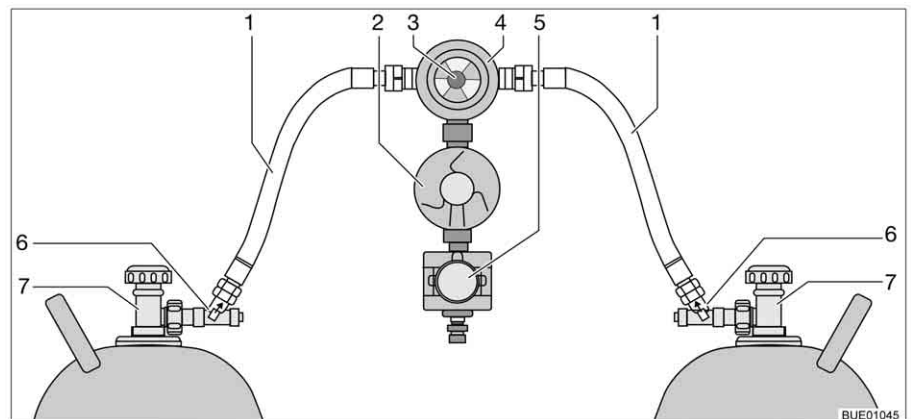

Fig. 154 Crash protection unit switching facility

Construction of the unit

The crash protection unit consists of two flow restrictors with manual release button (Fig. 154,6) a reversing valve (Fig. 154,4) with pressure regulator (Fig. 154,2), an electrovalve (Fig. 154,5) and the operating unit with tricoloured LED. The reversing valve is installed between the two gas tubes (Fig. 154,1).

Use the knob (Fig. 154,3) on the reversing valve to select which of the gas bottles is to be used as a primary bottle and which is to be used as a reserve bottle.



Fig. 155 Operating unit

Only the electrical functions can be switched at the operating unit (Fig. 155). The regulator taps on the gas bottles (Fig. 154,7) and the release buttons (Fig. 154,6) must be opened manually.

The reversing valve provides a constant gas pressure, regardless of which gas bottle is being drawn upon. The display in the reversing valve shows the filling level of the primary bottle. The gas supply comes from the primary bottle when the display is green. When the display is red the primary bottle is empty. In this case, the reserve bottle is used for the gas supply.

The indicator lamp on the operating unit shows the condition of the gas system. The system is okay when the indicator lamp (Fig. 155,1) lights up green. When the indicator lamp lights up or flashes red a fault has occurred. The gas supply is interrupted.

Putting into operation:

- Open the regulator taps of the gas bottles (Fig. 154,7).
- Press the release buttons (Fig. 154,6) successively for 10 seconds.
- Use the knob (Fig. 154,3) on the reversing valve (Fig. 154,4) to select the gas bottle which is to be the primary source of gas (primary bottle). Always turn the knob as far as it will go.
- Switch on the switching facility on the operating unit (Fig. 155). For this, set the rocker switch (Fig. 155,2) to "ON". The reversing valve is now deaerated. The indicator lamp (Fig. 155,1) flashes yellow (system test) and lights up green.

Switching off:

- Set the rocker switch (Fig. 155,2) to "OFF". The indicator lamp (Fig. 155,1) goes out.
- Close the regulator taps of the gas bottles (Fig. 154,7).



▶ When changing gas bottles, do not smoke or create any open fire.

Changing gas bottles:

- Turn the knob on the reversing valve. The display is green again. Should the display stay red the reserve bottle is also empty and has to be changed as well.
- Close regulator tap on the empty gas bottle.
- Unscrew the gas tube of the gas bottle.
- Release the fixing belts and remove the gas bottle.
- Place a new gas bottle in the gas bottle compartment.
- Fix gas bottle in place with the fixing belts.
- Connect the full gas bottle to the gas tube.

- Open regulator tap on the gas bottle.
- Press the release button for 10 seconds.
- Turn the knob on the reversing valve to the changed bottle. Open the release button when the display is green.
- Set the knob on the reversing valve with a half-turn, so that the newly replaced gas bottle will serve as a reserve bottle.

7.7 DuoControl switching facility (special equipment)



▶ Do not use the switching facility in closed spaces.



▷ Also read the manufacturer's instruction manual.

The DuoControl is an automatic switching facility with a remote display for a two-bottle gas system. The DuoControl switching facility automatically switches gas supply from the primary bottle to the reserve bottle as soon as the primary bottle is either empty or no longer ready for operation. The gas appliances may still continue operation. The DuoControl switching facility is suitable for all commercial gas bottles from 3 kg to 33 kg.

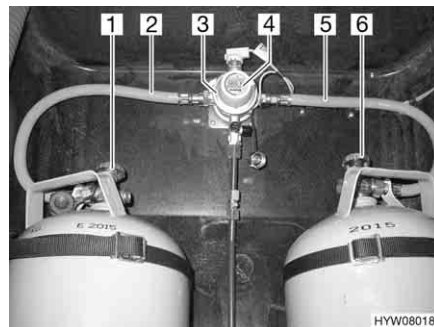

Fig. 156 DuoControl switching facility

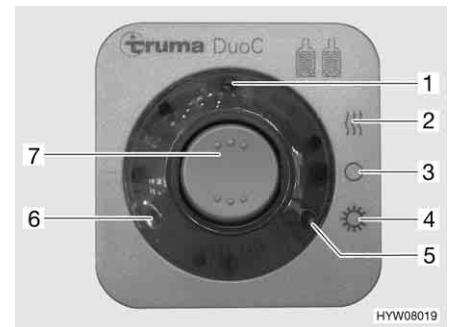

Fig. 157 Operating unit

Construction of the unit

The DuoControl switching facility consists of a reversing valve (Fig. 156,3) and an operating unit (Fig. 157). The reversing valve is installed between the gas tubes (Fig. 156,2 and 5). The knob (Fig. 156,4) on the reversing valve is used to select which of the gas bottles is to be used as a primary bottle and which is to be used as a reserve bottle.

The reversing valve is equipped with the regulator defroster Eis-Ex. This prevents damage to the gas system during the winter months.

Only the electrical functions can be switched at the operating unit (Fig. 157). The regulator taps on the gas bottles (Fig. 156,1 and 6) must be opened manually.

The reversing valve provides a constant gas pressure, regardless of which gas bottle is being drawn upon. The two indicator lamps on the operating unit indicate the level of the primary bottle. When the green indicator lamp (Fig. 157,6) illuminates, the primary bottle is full. When the red indicator lamp (Fig. 157,5) illuminates, the primary bottle is empty. In this case, the reserve bottle is used for the gas supply.

Operating modes

The DuoControl switching facility has two operating modes:

- Winter operation "On and heating"
- Summer operation "On"

Putting into operation:

- Open the regulator taps on the gas bottles (Fig. 156,1 and 6).
- Use the knob (Fig. 156,4) on the reversing valve (Fig. 156,3) to select the gas bottle which is to be the primary source of gas (primary bottle). Always turn the knob as far as it will go.
- Switch on the DuoControl switching facility at the operating unit (Fig. 157). To do so, set the rocker switch (Fig. 157,7) to winter operation "On and heating" (Fig. 157,2) or to summer operation "On" (Fig. 157,4). The reversing valve is now deaerated. The yellow indicator lamp (Fig. 157,1) illuminates if the winter operation has been selected and the regulator defroster is activated.

Switching off:

- Set the rocker switch (Fig. 157,7) to "O" (Fig. 157,3). The yellow indicator lamp (Fig. 157,1) goes out.
- Close the regulator taps on the gas bottles (Fig. 156,1 and 6).

Remote display

The indicator lamps on the operating unit (Fig. 157,5 and 6) indicate in the vehicle interior whether the primary bottle is ready for operation.

Changing gas bottles

If the green indicator lamp (Fig. 157,6) stops illuminating during operation and the red indicator lamp (Fig. 157,5) illuminates, the gas bottle selected as primary bottle is empty and needs to be changed. The reserve bottle continues supplying the gas appliances with gas.



- ▶ When changing gas bottles, do not smoke or create any open fire.

Changing gas bottles:

- Close the regulator tap on the empty gas bottle.
- Unscrew the gas tube of the gas bottle.
- Connect the full gas bottle to the gas tube.
- Open the regulator tap on the gas bottle.
- Set the knob on the reversing valve with a half-turn, so that the newly replaced gas bottle will serve as a reserve bottle.

7.8 Gas alarm system (special equipment)



- ▷ If the gas sensor or a cable is defective, the buzzer sounds until the defect has been rectified.
- ▷ If a deodorant spray, hairspray or a powerful cleaning agent is used in the immediate vicinity of the gas sensor, a false alarm may be triggered. Extended time in a tunnel (traffic jam) may also trigger a false alarm.
- ▷ Also read the manufacturer's instruction manual.

The gas alarm system has two functions:

- Alarm in the case of an attack with narcotic gas
- Alarm if there is a leak in the gas system

The gas alarm system is ready for operation as soon as the 12 V power supply is supplied with power.



Fig. 158 Gas sensor

The flashing LED (Fig. 158,2) next to the terminal block of the gas sensor (Fig. 158,1) indicates readiness for operation.

Switching off the buzzer:

- Briefly switch off the 12 V power supply and switch it on again (e.g. on the safety cut-out in the power pack).



Chapter overview

This chapter contains instructions regarding the electrical system of the vehicle.

The instructions address the following topics:

- safety
- explanations of terms relating to the battery
- 12 V power supply
- the radio selector switch
- starter battery
- living area battery
- transformer/rectifier
- panel
- fuel cell
- solar installation
- 230 V power supply
- connection to the 230 V power supply
- fuse rating
- external socket
- electrical wiring

The operation of the electrical appliances of the housing body is described in chapter 9.

8.1 General safety instructions



- ▶ Only allow qualified personnel to work on the electrical system.
- ▶ All electronic devices (e.g. mobile telephones, radios, televisions or DVD players) which have been retrofitted to the vehicle and are operated during the journey must have certain features: These are the CE certification, the EMC inspection (electromagnetic compatibility) and the "e"-inspection.

Only in this way can the functional reliability of the vehicle be ensured. Otherwise the airbag may be triggered or interference to the on-board electronics may result.



- ▷ During a storm, to protect the electrical devices disconnect the 230 V connection and retract the antennae.

8.2 Terms

Off-load voltage

The off-load voltage is the voltage of the battery in idle condition, i. e. no current is consumed and the battery is not being charged.



- ▷ The battery must remain idle for a while before measuring. After charging the last time, or after the last current has been drained by consumers, wait approximately 2 hours before measuring the idle voltage.

Closed circuit current

Some electrical appliances, such as the clock and the indicator lamps, require continuous electric current, for this reason they are referred to as inactive appliances. This closed circuit current flows even if the device has been switched off.

Total discharge

Total discharge of the battery is imminent, if a battery is completely discharged by an active appliance and by closed circuit current and the off-load voltage falls below 12 V.



- ▷ Total discharge damages the battery.

Capacity

Capacity refers to the amount of electricity which can be stored in a battery. The capacity of a battery is given in ampere hours (Ah). The so-called K20 value is normally used.

The K20 value indicates how much current a battery is able to dispense over a time period of 20 hours without causing damage, or how much current is required to charge a flat battery within 20 hours.

For example, if a battery can dispense 4 amps for 20 hours, then it has a capacity of $4 \text{ A} \times 20 \text{ h} = 80 \text{ Ah}$.

If more current flows, the capacity of the battery reduces proportionately.

External influences, such as temperature and age may alter the storage capacity of the battery. Capacity details refer to new batteries operating at room temperature.



- ▷ Depending on battery technology, capacity details have a conversion factor of 1.3 to 1.7, which lowers the real capacity by this value.

8.3 12 V power supply

- ▷ Only connect devices with a maximum of 10 A to the sockets of the 12 V power supply.

8.3.1 Selector switch for radio (special equipment)

- ▷ Depending on the equipment level, a radio with integrated navigation device or a multimedia station will be present, referred to below simply as a "radio".



Fig. 159 Selector switch for operating behaviour

Switching the radio on and off with the ignition:

- Set the selector switch to the "0" position. The radio will be switched on and off with the ignition.

Operating the radio from the living area battery:

- Set the selector switch to the "1" position. The radio will be powered at all times from the living area battery.

8.3.2 Starter battery

The starter battery serves for starting the engine and supplies the electrical appliances of the base vehicle as well as optional devices such as the radio, navigation system or central locking system with voltage. See the instruction manual of the base vehicle for the position of the starter battery.



- ▷ For models with a Fiat base vehicle, the radio in the driver's cabin is connected to the living area battery.

Discharging

This section contains information regarding the discharge of the starter battery.



- ▷ Total discharge damages the battery.
- ▷ Once a battery with acid is discharged, it can freeze in temperatures of below zero. This damages the battery.
- ▷ Recharge battery in good time.

The starter battery will be totally discharged via a closed circuit current (inactive appliances). Inactive appliances are optional devices such as a radio, alarm system, navigation system or a central locking system. Inactive appliances discharge the starter battery when the vehicle engine is switched off.

Low temperatures outside reduce the capacity available.

Charging

This section contains information regarding the charging of the starter battery.



- ▶ The acid in the battery is poisonous and corrosive. Any contact with the skin or the eyes is to be avoided.
- ▶ In the case of charging with an external charger there is danger of explosion. Sparks can be caused by attaching the battery terminals. Only charge the battery in a well ventilated area and away from naked flames or possible sources of sparks. Batteries can develop and release gases.



- ▷ Charge the battery for at least 20 hours before laying up.
- ▷ Do not connect the battery cables to the wrong poles.
- ▷ If the starter battery or living area battery are disconnected, do not apply the ignition. There is a danger of short circuit from exposed cable ends.
- ▷ Before disconnecting or connecting the terminals of the battery, switch off the vehicle engine as well as the 230 V and 12 V power supplies and all appliances. Danger of short circuit!
- ▷ Observe the instruction manuals for the base vehicle and the charger.

The starter battery can only be fully charged with an external charger. When the vehicle is connected to the 230 V power supply, the transformer/rectifier charges the starter battery with a float charge only. Even in mobile operation, the vehicle engine alternator has a limited capability of completely charging the starter battery.

When charging the starter battery with an external charger, proceed as follows:

- Turn off the vehicle engine.
- Switch off the 12 V power supply on the panel. The indicator lamps or the displays on the panel go out.
- Switch off all gas appliances, all gas isolator taps and close the regulator tap on the gas bottle.
- Disconnect the starter battery from the vehicle (e.g. remove the battery terminals). There is a danger of short circuit when disconnecting the battery poles. For this reason, first disconnect the negative terminal on the starter battery and then the positive.
- Check that the external charger is turned off.
- Connect the external charger to the starter battery. Pay attention to the polarity: First connect the positive terminal "+" to the positive terminal of the starter battery, then connect the negative terminal "-" to the negative pole of the starter battery.
- Switch on the external charger.
- See the instructions for use of the connected charger for information concerning charge period required for the battery.
- See the specifications on the battery for information concerning its strength.
- Disconnect the charger in reverse order (the negative terminal first).
- Connect the battery terminals again (first the positive terminal).

8.3.3 Living area battery



- ▷ Use only the built-in transformer/rectifier to load the living area battery.
- ▷ Prior to commencing a journey ensure the living area battery is fully charged. For this reason charge the living area battery for at least 20 hours before commencing the journey.
- ▷ During the trip, use every opportunity to charge the living area battery.
- ▷ Charge the living area battery for at least 20 hours after the journey.
- ▷ Charge the battery for at least 20 hours before laying up.
- ▷ When the living area battery is changed, only use batteries of the same type.
- ▷ If there are several living area batteries, always change all the batteries together. The batteries must **always** be the same age and have the same capacity.
- ▷ When changing the living area battery, use only batteries which meet the minimum capacity of the charger. Observe the separate instruction manual for the charger. Lower-capacity batteries will generate a great deal of heat when they are charged. Danger of explosion!
- ▷ If the living area battery is replaced and the charging unit does not provide at least 10 % of the rating of a new battery, install an auxiliary charging unit. Example: With a battery capacity of 80 Ah, the charging unit must supply at least 8 A charging current.
- ▷ Before disconnecting or connecting the terminals of the battery, switch off the vehicle engine as well as the 230 V and 12 V power supplies and all appliances. Danger of short circuit!
- ▷ If the starter battery or living area battery are disconnected, do not apply the ignition. There is a danger of short circuit from exposed cable ends.



- ▷ For models with a Fiat base vehicle, the radio in the driver's cabin is connected to the living area battery.

When the vehicle is not connected to the 230 V power supply or the 230 V power supply is switched off, the living area battery supplies the living area with 12 V DC. The living area battery has a limited power supply only. For this reason, electrical appliances such as the radio and the lights should not be operated for a long time without using the 230 V power supply.

Position See chapter 16.

Discharging

The living area battery is discharged by the closed circuit current which some electrical appliances continuously require.



- ▷ Total discharge damages the battery.
- ▷ Recharge battery in good time.

A completely charged living area battery will be totally discharged via a closed circuit current (inactive appliances).

Low temperatures outside reduce the capacity available.

The self-discharge rate of the battery is also dependant on temperature. At 20 to 25 °C the self-discharge rate is approx. 3 % of the capacity per month. The self-discharge rate will increase with rising temperatures: At 35 °C the self-discharge rate is approx. 20 % of the capacity per month.

An older battery no longer has the complete capacity available.

The higher the number of active electrical appliances, the faster the energy of the living area battery is consumed.

Charging

Only use the transformer/rectifier to charge the living area battery. Therefore, connect the vehicle to a 230 V power supply system as often as possible.



- ▷ Charge the battery for at least 48 hours after a total discharge.



- ▷ Further information can be obtained in the separate documentation for the living area battery.

8.4 Transformer/rectifier (EBL 99)



- ▷ Do not cover the ventilation slots. Danger of overheating!



- ▷ Depending on the model, not all slots for the fuses are occupied.
- ▷ If there are several living area batteries, use an auxiliary charging unit.
- ▷ Further information can be obtained in the manufacturer's instruction manual.

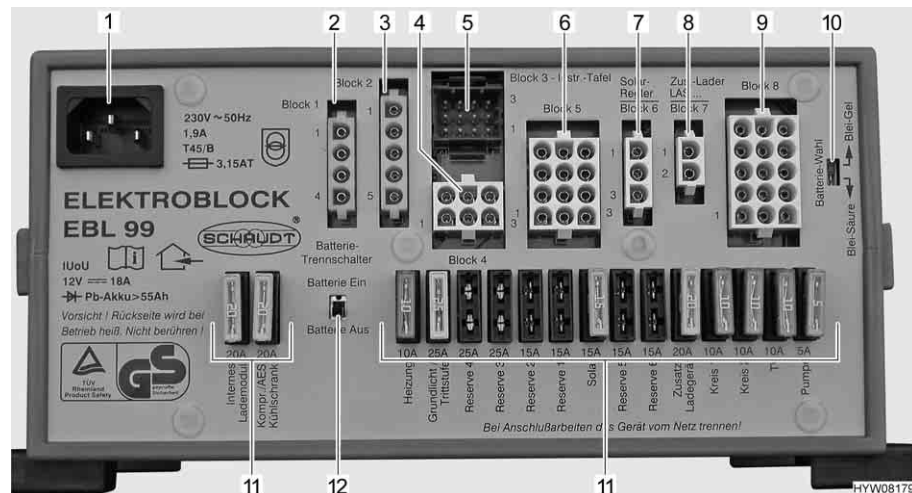

Fig. 160 Transformer/rectifier (EBL 99)

- 1 Main supply socket 230 V~
- 2 Block 1: Refrigerator output (D+, heating cartridge)
- 3 Block 2: Refrigerator output from starter battery, alternator D+
- 4 Block 4: Heating output, basic light (lighting in the entrance area), entrance step
- 5 Block 3: Panel outlet
- 6 Block 5: Reserve output 2, reserve 3, reserve 4, appliance with constant positive (e.g. satellite device, defroster)
- 7 Block 6: Solar charge regulator input (if fitted)
- 8 Block 7: Auxiliary charging unit input, fuel cell
- 9 Block 8: Appliance circuit output 1, appliance circuit 2, TV, water pump, reserve 1, reserve 5, reserve 6
- 10 Battery selector switch ("Blei-Säure/Blei-Gel" (lead acid/dryfill))
- 11 Fuses
- 12 Battery cut-off switch ("Batterie Ein/Aus" (battery On/Off))

Functions The transformer/rectifier has the following functions:

- The transformer/rectifier charges the living area battery. The transformer/rectifier charges the starter battery with a float charge only.
- The transformer/rectifier monitors the voltage in the living area battery.
- The transformer/rectifier distributes the current to the 12 V circuits and secures them. Devices with a maximum of 10 A can be connected to the sockets.
- The transformer/rectifier provides connections for a solar charge regulator, an auxiliary charging unit, as well as other control and monitoring functions.
- When the engine is turned off, the transformer/rectifier separates the starter battery electrically from the living area battery. This prevents the 12 V living area appliances from discharging the starter battery.
- The battery cut-off switch in the transformer/rectifier separates all the appliances from the living area battery.

The transformer/rectifier only works in conjunction with a panel.

The power in the transformer/rectifier (> 18 A) is divided into charging current and current to the appliances. The charging current is always just the portion that is not being used by any appliances. If the current to the appliances exceeds the current available, then the living area battery is discharged.

Position See chapter 16.

8.4.1 Battery cut-off switch

The battery cut-off switch switches off **all** the appliances in the living area, even inactive ones. Even appliances such as the entrance step, basic lighting or the refrigerator will stop working. This prevents the living area battery from slowly discharging if the vehicle is not used for a longer period of time (e.g. temporary lay-up).

If the vehicle is connected to the 230 V power supply, the batteries can then be charged from the transformer/rectifier, even if the battery cut-off switch is switched off.

This also applies for charging via a solar installation or fuel cell.

8.4.2 Battery selector switch



- ▶ If the battery selector switch is set incorrectly, there is the danger of the formation of detonating (oxy-hydrogen gas). Danger of explosion!



- ▷ Incorrect setting of the battery selector switch damages the living area battery.
- ▷ The factory settings of the battery selector switch must not be changed.

8.4.3 Battery monitor



- ▷ You must fully recharge a discharged living area battery as soon as possible.

The battery monitor in the transformer/rectifier monitors the voltage in the living area battery.

If the battery voltage falls below 10.5 V, the battery monitor in the transformer/rectifier switches off all the 12 V appliances. The battery cut-off switch is activated.

Measures:

- Switch off all electrical appliances that are not absolutely essential at the corresponding switch.
- If necessary, use the 12 V main switch to switch the 12 V power supply back on for a short while. This is only possible, however, when the battery voltage is above 11 V. If the voltage is below this level, the 12 V power supply cannot be switched on again until the living area battery has been recharged.

8.4.4 Charging the battery

When the vehicle engine is running, a relay in the transformer/rectifier alternator switches on the living area battery and the starter battery together and recharges them with the vehicle generator. When the vehicle engine is switched off, the batteries are automatically disconnected from one another again by the transformer/rectifier. This prevents the starter battery from being run down by electrical appliances in the living area. The starting capability of the vehicle is thus preserved. The terminal voltage of the living area battery or the starter battery can be read on the panel.

If the vehicle is connected to the 230 V power supply, the living area battery and the starter battery are automatically charged by the charger module on the transformer/rectifier. The starter battery is only charged with a float charge. The charging current is adapted to suit the charging condition of the battery. This ensures that it is not possible to overload the battery.

To make use of the maximum output from the charger module on the transformer/rectifier, switch off all electrical appliances during charging.

8.5 Panel IT 96-2

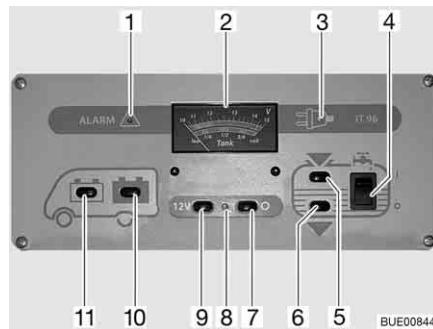

Fig. 161 Panel IT 96-2

- 1 "ALARM" warning light for the living area battery
- 2 V/tank gauge
- 3 230 V indicator lamp
- 4 Rocker switch for water pump On/Off
- 5 Switch for reading the filling level in the water tank
- 6 Switch for reading the filling level in the waste water tank
- 7 12 V main switch "OFF"
- 8 12 V indicator lamp
- 9 12 V main switch "ON"
- 10 Switch for reading the battery voltage of the living area battery
- 11 Switch for reading the battery voltage of the starter battery

8.5.1 12 V main switch

The 12 V main switch (Fig. 161,7 and 9) switches the panel and the 12 V power supply to the living area on and off.

Exception: Depending on the model, heater, basic light (lighting in the entrance area), entrance step, spare 4 and a refrigerator with automatic power selection system (AES) remain ready to operate.

Switching on: ■ Press switch (Fig. 161,9) "12 V": The 12 V living area power supply is switched on. The indicator lamp (Fig. 161,8) lights up green.

Switching off: ■ Press switch (Fig. 161,7) "O": The 12 V living area power supply is switched off. The indicator lamp (Fig. 161,8) goes out.





- ▷ When leaving the vehicle, switch off the main 12 V power supply at the panel. This prevents any unnecessary discharge of the living area battery.
- ▷ Appliances, such as control units (e.g. solar charge regulator, defroster or panel) or fitted appliances (e.g. heating, refrigerator or step) continue to take power from the battery capacity, even if the 12 V power supply on the panel is switched off. Therefore disconnect the living area battery from the 12 V power supply via the switch on the transformer/rectifier if the vehicle will not be used for a long period of time.

8.5.2 V/tank gauge for battery voltage and water or waste water levels

Battery voltage

The V/tank gauge is for the indication of the battery voltage of the starter battery or the living area battery.

With the V/tank gauge (Fig. 161,2), note the top scale. The gauge automatically lights up as soon as a switch is pressed.

- Displays:*
- Press switch (Fig. 161,11) : The battery voltage of the starter battery is displayed.
 - Press switch (Fig. 161,10) : The battery voltage of the living area battery is displayed.

The following tables will help you correctly interpret the battery voltage of the living area battery displayed on the panel IT 96.

Danger of total discharge (battery alarm)

Battery voltage (values during operation)	Mobile operation (vehicle moving, no 230 V connection)	Battery operation (vehicle stationary, no 230 V connection)	Power operation (vehicle stationary, 230 V connection)
11 V or less ¹⁾	12 V power supply overload	If appliances are switched off: Battery flat If appliances are switched on: Battery overload	12 V power supply overload
	The battery is not charged by the alternator, the alternator's regulator is defective		The battery is not charged by the transformer/rectifier, the transformer/rectifier is defective
11.5 V to 13.2 V	12 V power supply overload ²⁾	Normal range	12 V power supply overload ²⁾
	The battery is not charged by the alternator, the alternator's regulator is defective		The battery is not charged by the transformer/rectifier, the transformer/rectifier is defective
13.3 V to 13.7 V	Battery is being charged (main charge)	Occurs only briefly after charging	Battery is being charged (main charge)
13.8 V to 14.4 V	Battery being charged (float charge)	–	Battery being charged (float charge)
Over 14.5 V	Battery is overcharged, defective alternator control	–	Battery is overcharged, defective transformer/rectifier

¹⁾ The battery guard switches all the appliances off (at 10.5 V).

²⁾ If the voltage does not exceed this range for several hours.

Values for off-load voltage	Charging condition of the battery
Less than 11 V	Totally discharged
12.0 V	0 %
12.2 V	25 %
12.3 V	50 %
12.5 V	75 %
More than 12.8 V	100 %



- ▷ Total discharge causes irreparable damage to the battery.





- ▷ Measure the off-load voltage preferably several hours after the previous charging (e.g. in the morning) and not directly after a current drain.

Volume of water/waste water

The V/tank gauge is for the indication of the quantity of water or waste water. With the V/tank gauge (Fig. 161,2), use the bottom scale. The gauge automatically lights up as soon as a switch is pressed.

Displays:

- Press switch (Fig. 161,5) "": The volume of water is displayed.
- Press switch (Fig. 161,6) "": The volume of waste water is displayed.



- ▷ Only read the tank levels briefly. Keeping the reading option on for a long time can damage the transducers.

8.5.3 Switch for water pump

Switching on:

- Press the upper part of the rocker switch (Fig. 161,4) "I": The water supply is ON.

Switching off:

- Press the lower part of the rocker switch (Fig. 161,4) "O": The water supply is OFF.



- ▷ If the vehicle is not connected to the 230 V power supply and the water pump is not used for a longer period of time: Switch off the power supply for the water pump. The pump relay uses around 4 Ah current each day.

8.5.4 Battery alarm for the living area battery

The red "ALARM" warning light (Fig. 161,1) flashes as soon as the voltage of the living area battery falls below 11 V (measured under operation) and there is a risk of a total discharge.



- ▷ Total discharge damages the battery.



- ▷ If the battery voltage falls below 10.5 V, the battery monitor in the transformer/rectifier switches off all the 12 V appliances. The battery cut-off switch is activated.

Measures:

- When the battery alarm comes on, switch off the appliances and charge the living area battery, either by mobile operation or by connection to a 230 V power supply.

8.5.5 12 V indicator lamp

The 12 V indicator lamp (Fig. 161,8) illuminates whenever the 12 V main switch (Fig. 161,9) is switched on.

8.5.6 230 V indicator lamp

The yellow 230 V indicator lamp (Fig. 161,3) illuminates whenever line voltage is available at the transformer/rectifier input.



▷ Further information can be obtained in the manufacturer's instruction manual.

8.6 Panel IT 994



▷ Further information can be obtained in the manufacturer's instruction manual.

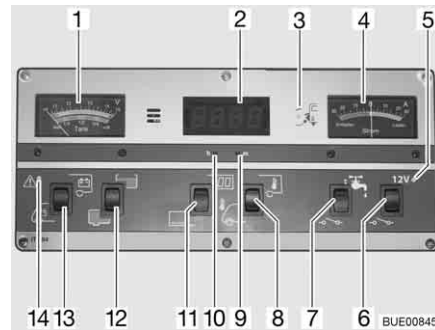

Fig. 162 Panel IT 994

- 1 V/tank gauge
- 2 Digital clock/temperature gauge
- 3 230 V indicator lamp
- 4 Current gauge
- 5 12 V indicator lamp
- 6 12 V main switch
- 7 Rocker switch for water pump On/Off
- 8 Rocker switch °C for reading internal temperature or external temperature
- 9 Setting the digital clock - minutes
- 10 Setting the digital clock - hours
- 11 Rocker switch display On/Off
- 12 Rocker switch for reading the level in the water or waste water tanks
- 13 Rocker switch for reading the battery voltage of the starter and living area batteries
- 14 ALARM warning light for the living area battery

8.6.1 V/tank gauge for battery voltage and water or waste water levels

Battery voltage

The V/tank gauge is for the indication of the battery voltage of the starter battery or the living area battery.

With the V/tank gauge (Fig. 162,1), note the top scale. The gauge automatically lights up as soon as a switch is pressed.

Displays:

- Press the lower part of the rocker switch (Fig. 162,13): The battery voltage of the starter battery is displayed.
- Press the upper part of the rocker switch (Fig. 162,13): The battery voltage of the living area battery is displayed.

The following tables will help you correctly interpret the battery voltage of the living area battery displayed on the panel IT 994.

Danger of total discharge (battery alarm)

Battery voltage (values during operation)	Mobile operation (vehicle moving, no 230 V connection)	Battery operation (vehicle stationary, no 230 V connection)	Power operation (vehicle stationary, 230 V connection)
11 V or less ¹⁾	12 V power supply overload	If appliances are switched off: Battery flat	12 V power supply overload
	The battery is not charged by the alternator, the alternator's regulator is defective	If appliances are switched on: Battery overload	The battery is not charged by the transformer/rectifier, the transformer/rectifier is defective
11.5 V to 13.2 V	12 V power supply overload ²⁾	Normal range	12 V power supply overload ²⁾
	The battery is not charged by the alternator, the alternator's regulator is defective		The battery is not charged by the transformer/rectifier, the transformer/rectifier is defective
13.3 V to 13.7 V	Battery is being charged (main charge)	Occurs only briefly after charging	Battery is being charged (main charge)
13.8 V to 14.4 V	Battery being charged (float charge)	–	Battery being charged (float charge)
Over 14.5 V	Battery is overcharged, defective alternator control	–	Battery is overcharged, defective transformer/rectifier

¹⁾ The battery guard switches all the appliances off (at 10.5 V).

²⁾ If the voltage does not exceed this range for several hours.

Values for off-load voltage	Charging condition of the battery
Less than 11 V	Totally discharged
12.0 V	0 %
12.3 V	50 %
12.5 V	75 %
More than 12.8 V	Full



▷ Total discharge causes irreparable damage to the battery.



▷ Measure the off-load voltage preferably several hours after the previous charging (e.g. in the morning) and not directly after a current drain.

Volume of water/waste water

The V/tank gauge is for the indication of the quantity of water or waste water.

With the V/tank gauge (Fig. 162,1), use the bottom scale. The gauge automatically lights up as soon as a switch is pressed.

Displays:

- Press the upper part of the rocker switch (Fig. 162,12): The volume of water is displayed.
- Press the lower part of the rocker switch (Fig. 162,12): The volume of waste water is displayed.



- ▷ Only read the tank levels briefly. Keeping the reading option on for a long time can damage the transducers.

8.6.2 Battery alarm for the living area battery

The red ALARM warning light (Fig. 162,14) flashes as soon as the voltage of the living area battery falls below 11 V (measured under operation) and there is a risk of a total discharge.



- ▷ Total discharge damages the battery.



- ▷ If the battery voltage falls below 10.5 V, the battery monitor in the transformer/rectifier switches off all the 12 V appliances. The battery cut-off switch is activated.

Measures:

- When the battery alarm comes on, switch off the appliances and charge the living area battery, either by mobile operation or by connection to a 230 V power supply.

8.6.3 Digital clock/temperature gauge

Digital clock

The buttons under the gauge can be used to switch the digital clock on and off and to set it.

Switching on:

- Press the upper part of the rocker switch (Fig. 162,11): Digital clock display is switched on. Temperature display is ready to operate.

Switching off:

- Press the lower part of the rocker switch (Fig. 162,11): Digital clock display and temperature display are switched off.

Adjusting:

- Press a thin device, such as a biro, into the opening for the hour display (Fig. 162,10) until the correct hours are displayed.
- Press a thin device, such as a biro, into the opening for the minute display (Fig. 162,9) until the correct minutes are displayed.



- ▷ The digital clock will go on running even when the digital clock display is switched off. The actual time can always be read.
- ▷ The digital clock loses the current time when the living area battery is disconnected. When the living area battery is reconnected, the display reads 00:00 and must be re-set.

Temperature display

The digital clock/temperature gauge is for the indication of the internal or external temperature.

The temperature display is only ready for operation if the digital clock display is switched on. After a reading, the respective temperature will be displayed for approx. 6 seconds.

- Displays:*
- Press the upper part of the rocker switch (Fig. 162,8): The internal temperature is displayed.
 - Press the lower part of the rocker switch (Fig. 162,8): The external temperature is displayed.

8.6.4 Current gauge for charging/discharging the living area battery

The battery current actually flowing is permanently displayed on the current gauge (Fig. 162,4). The gauge automatically lights up as soon as a switch is pressed.

- Red "discharging" zone: Battery is being discharged at the discharging current indicated between 0 and 30 A.
- Indicator "0": Battery is neither being charged nor discharged.
- Green "charging" zone: Battery is being charged at the charging current indicated between 0 and 30 A.

Notes for charging/ discharge display

Display	Mobile operation (vehicle moving, no 230 V con- nection)	Battery opera- tion (vehicle station- ary, no 230 V connection)	Power operation (vehicle station- ary, 230 V con- nection)
Red "discharg- ing" zone (dis- charging current)	No charge! Too many appli- ances are switched on or the alternator is de- fective	Appliances are on Battery is being discharged	No charge! Too many appli- ances are switched on
0 A (there is no current)	Battery fully or vir- tually charged ¹⁾	Appliances are switched off	Battery fully or vir- tually charged ²⁾
Green zone (charging current)	Battery is being charged (up to 30 A possible)	Battery is being charged (only possible with solar power)	Battery is being charged (up to max. 16 A possi- ble; with 32 A auxiliary charging unit)

¹⁾ If the indicator falls from the green range to 0 and all appliances are switched off (apart from the refrigerator).

²⁾ If the indicator falls from the green range to 0 and all appliances are switched off.

8.6.5 12 V main switch

The 12 V main switch (Fig. 162,6) switches the panel and the 12 V power supply of the living area on and off.

Exception: Depending on the model, heater, basic light (lighting in the entrance area), entrance step, spare 4 and a refrigerator with automatic power selection system (AES) remain ready to operate.

Switching on: ■ Press the upper part of the rocker switch (Fig. 162,6): The 12 V living area power supply is switched on. The indicator lamp (Fig. 162,5) lights up green.

Switching off: ■ Press the lower part of the rocker switch (Fig. 162,6): The 12 V living area power supply is switched off. The indicator lamp (Fig. 162,5) goes out.



- ▷ When leaving the vehicle, switch off the main 12 V power supply at the panel. This prevents any unnecessary discharge of the living area battery.
- ▷ Appliances, such as control units (e.g. solar charge regulator, defroster or panel) or fitted appliances (e.g. heating, refrigerator or step) continue to take power from the battery capacity, even if the 12 V power supply on the panel is switched off. Therefore disconnect the living area battery from the 12 V power supply via the switch on the transformer/rectifier if the vehicle will not be used for a long period of time.

8.6.6 12 V indicator lamp

The 12 V indicator lamp (Fig. 162,5) illuminates whenever the 12 V main switch (Fig. 162,6) is switched on.

8.6.7 230 V indicator lamp

The yellow 230 V indicator lamp (Fig. 162,3) illuminates whenever line voltage is available at the transformer/rectifier input.

8.6.8 Switch for water pump

Switching on: ■ Press the upper part of the rocker switch (Fig. 162,7): The water supply is ON.

Switching off: ■ Press the lower part of the rocker switch (Fig. 162,7): The water supply is OFF.



- ▷ If the vehicle is not connected to the 230 V power supply and the water pump is not used for a longer period of time: Switch off the power supply for the water pump. The pump relay uses around 4 Ah current each day.

8.7 Fuel cell (EFOY) (special equipment)



- ▶ Methanol is toxic. Avoid inhaling, swallowing or any contact with the skin or the eyes.
- ▶ If methanol leaks, there is a danger of fire. Keep away from sources of ignition and ventilate well. Methanol evaporates without residue.
- ▶ Always adhere to the safety data sheet from the manufacturer.
- ▶ The fuel cell must not be opened.
- ▶ The tank cartridge must not be opened with force or refilled.
- ▶ Keep fuel cell and tank cartridges – including empty or half-empty tank cartridges – out of the reach of children.
- ▶ When used in vehicles, the fuel cell and the tank cartridges must be secured to avoid accidents.



- ▷ Do not store the fuel cell at temperatures above 45 °C or below 1 °C.
- ▷ Do not operate the fuel cell at temperatures above 40 °C or below -20 °C.
- ▷ When the appliance is connected to an intact battery, the frost protection switches on automatically if the ambient temperature drops below 3 °C, even if the fuel cell is switched off. Therefore always connect a full tank cartridge and a sufficiently charged battery, if it is stored below 3 °C.
- ▷ If the fuel cell freezes despite taking all precautions, leave the appliance to defrost at room temperature for approx. 24 hours in a switched off state. Then it can be used again.
- ▷ Do not cover the ventilation holes on the fuel cell. Danger of overheating!
- ▷ The fuel cell is not waterproof. Clean casing only with a slightly damp cloth and ensure that water does not enter the device.



- ▷ The minimum running time of the fuel cell is 30 minutes. If the On/Off key is pressed during this period, the fuel cell only shuts down when this minimum operating time expires. The LEDs light up on during this time.
- ▷ Further information can be obtained in the instruction manual for the fuel cell.

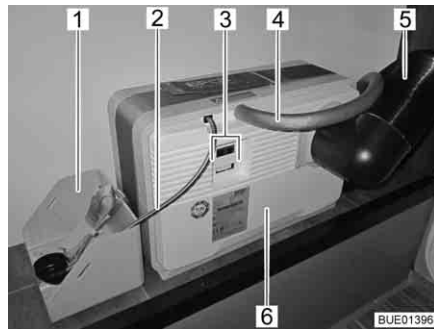

Fig. 163 Fuel cell with tank cartridge

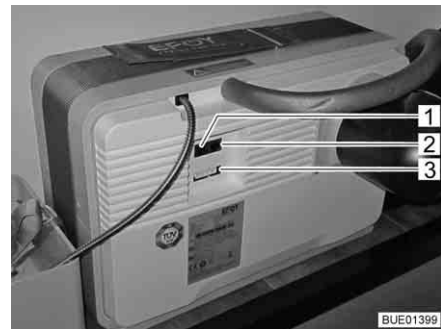

Fig. 164 Connector panel of the fuel cell

The fuel cell consists of several components that are installed in the rear storage space (Fig. 163) and of an operating unit (Fig. 165) in the living area. The following components are on the fuel cell (Fig. 163,6):

- The connector for the air discharge hose (Fig. 163,4) or the filling hole for the service fluid
- the off-heat tube (Fig. 163,5)
- electrical connections (Fig. 163,3) with data interface (Fig. 164,2), device connection (Fig. 164,3) and connection for the operating panel (Fig. 164,1)

A tank cartridge belongs to the fuel cell (Fig. 163,6). It is connected to the fuel cell via a tank connection (Fig. 163,2).

The tank cartridge is firmly fixed in the tank cartridge holder (Fig. 163,1).

The fuel cell automatically charges the living area batteries if their voltage falls below 12,3 V and if the fuel cell is switched on using the On/Off key (Fig. 165,8).

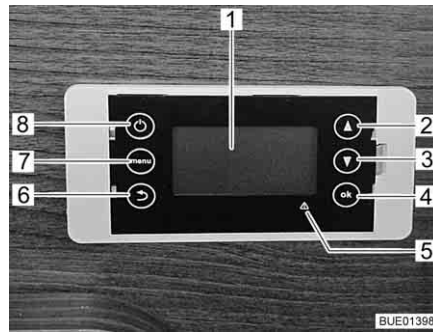

- 1 Display
- 2 Scroll upwards through menu
- 3 Scroll downwards through menu
- 4 Confirmation/OK
- 5 Fault display (red LED)
- 6 Back
- 7 Menu
- 8 On/Off

Fig. 165 Operating unit fuel cell

Operating unit

The display (Fig. 165,1) of the operating unit has four lines.

The first line displays the selected operating mode:

- Automatic
- On
- Off

The second line displays the current operating status:

- Standby
- Charging mode
- Shutdown procedure
- Battery protection
- Antifreeze

The other two rows show information such as battery voltage, charging current and filling level of the tank cartridge.

The main menu can be accessed with the menu key (Fig. 165,7):

- Operating mode
- Fuel cartridge
- System information
- Language
- System reset

In the event of faults, the red fault indicator (Fig. 165,5) lights up and a message appears on the display. The message consists of an error code and information on how to rectify the fault.

After rectifying the fault, carry out a system reset.

If the tank cartridge needs to be changed or service fluid replenished, this will also be indicated.

Switching on:

- Press the On/Off key.
- Select the desired operating mode and confirm with "OK".

Switching off:

- Press the On/Off key.
- Select the "Manual Off" operating mode and confirm with "OK". The fuel cell switches itself off in a controlled way. This procedure can take a while. "Shutdown procedure" appears on the display.

Automatic mode

Automatic mode starts as soon as the device is attached to the power supply. The device monitors the battery voltage independently.

The fuel cell switches itself on automatically when the battery voltage falls below 12.3 Volts. The battery is then charged to reach the switch-off threshold (14.2 Volts).

When started, the device runs through a start phase lasting up to 20 minutes. Only after this period is its full nominal power reached.

Battery protection

This function prevents the battery from discharging completely when the operating mode is set to "Off".

Battery protection is activated automatically when the battery voltage falls below 11.2 Volts for more than 15 minutes. The "Battery protection" charge mode ends when the voltage of 12.8 Volts is reached.

Frost protection

This mode is triggered automatically as soon as the temperature falls below 3 °C. It prevents the device from freezing.



- ▶ Observe the safety instructions for methanol.

Replacing the tank cartridge:

- Unscrew the tank cartridge connection from the empty tank cartridge.
- Loosen the securing belt on the tank cartridge.
- Remove empty tank cartridge from the tank cartridge holder.
- After use, firmly close the cap of the tank cartridge.
- Insert a new, sealed original tank cartridge into the tank cartridge holder.
- Secure the tank cartridge with the securing belt.
- Open cap and keep safe.
- Screw tank cartridge connection onto the new tank cartridge.
- In the "Main Menu > Fuel Cartridge" menu, specify the tank cartridge size used and confirm with "OK".

8.8 Solar installation (special equipment)



- ▷ Protect the solar collectors (solar module) against mechanical overload.



- ▷ The solar installation supplies the most current under optimal sunlight conditions.
- ▷ Provide the solar collectors (solar module) open access to sunlight.
- ▷ Sunlight is greater in the open air than under trees and bridges.
- ▷ Tarpaulins block out sunlight.
- ▷ Always keep collector surfaces free of contamination.
- ▷ Also read the manufacturer's instruction manual.

The solar installation provides an environmentally compatible power supply independent of the mains. It converts energy from sunlight into electric current. The solar installation supplies additional current for the battery and appliances.

The solar charge regulator has an integrated overload protection and back flow valve. The charging current is automatically reduced or the solar collectors (solar modules) are switched off if the solar power is not sufficient (e.g. at night).



Fig. 166 Solar charge regulator

The operating display is by means of two LEDs (Fig. 166,1 and 2). The LEDs indicate the current operating status by means of different brightness. The higher the charge status of the battery, the brighter the LED lights "100 % ↑" (Fig. 166,1) and, the lower the charge status of the battery, the lower the LED lights "20 % ↓" (Fig. 166,2).

LED	Status	Signification
100 % ↑ 20 % ↓	Off	Solar power insufficient
100 % ↑ 20 % ↓	Lights	Battery being charged
100 % ↑ 20 % ↓	Lights brightly Glows weakly	Charging current limited to trickle charging current

8.9 230 V power supply



- ▶ Only allow qualified personnel to work on the electrical system.
- ▶ Have the vehicle's electrical system checked by a qualified electrician at least once every 3 years. If the vehicle is used frequently, an annual check is recommended.

The 230 V power supply provides electricity for:

- sockets with earth contact for appliances with maximum 16 A
- refrigerator
- transformer/rectifier
- an auxiliary charging unit
- air conditioning unit

The electrical appliances connected to the 12 V power supply of the living area are supplied with voltage by the living area battery.

Connect the vehicle to an external 230 V power supply system as often as possible. The charger module in the transformer/rectifier automatically charges the living area battery. In addition to this, the starter battery is charged with a float charge of approx. 2 A.

Depending on the equipment, the air conditioning unit and other optional devices are fuse-protected by their own safety cut-out (16 A).

8.9.1 230 V connection

Requirements concerning the 230 V connection

- The connection cable, the plug connectors at the point of supply and the plug connector to the vehicle must comply with IEC 60309. The standard designation for the plug connectors is "CEE blue".
- Use H07RN-F rubber sheathed cable with a minimum cable cross-section of 2.5 mm² and a maximum length of 25 m.
- Earth contact connectors (safety) are not permitted. The interconnection of CEE/safety adapters is also prohibited.

8.9.2 Connecting 230 V power supply



- ▶ The external 230 V power supply must be protected by fuse with a fault current protection switch (FI-switch, 30 mA).
- ▶ To prevent overheating, the cable must be fully uncoiled from the cable reel.
- ▶ In case of doubt or if the 230 V supply is not available or is faulty, contact the operator of the power supply device.



- ▷ The 230 V connection in the vehicle is equipped with a fault current protection switch (FI-switch).
- ▷ For the connection points on camp sites (camping distributors) fault current protection switches (FI-switches, 30 mA) are obligatory.

The vehicle can be connected to an external 230 V power supply.



Fig. 167 230 V fuse box with safety cut-out and FI-switch



Fig. 168 230 V connection on vehicle

Connecting the vehicle:

- Check whether the power supply device is suitable regarding connection, voltage, frequency and current.
- Check whether the cables and connections are suitable.
- Check the plug connectors and cables for visible damage.
- Switch off the safety cut-out (Fig. 167, 1 and 2) in the fuse box (Fig. 167, 3).
- Open the cover of the 230 V connection on the vehicle (Fig. 168) and insert the plug connector. Ensure that the detent of the spring-mounted pivoting cover is engaged in position.
- Plug the connector of the connecting cable into the socket of the power supply device. Ensure that the detent of the spring-mounted pivoting cover is engaged in position.
- Switch on the safety cut-out in the fuse box.

Checking the fault current protection switch:

- When the vehicle is connected to the 230 V supply, press the check button (Fig. 167,5) of the fault current protection switch (FI-switch) (Fig. 167,4) in the fuse box (Fig. 167,3). The fault current protection switch must trip.
- Switch the fault current protection switch back on again.

Unplugging the connection:

- Switch off the safety cut-outs (Fig. 167,1 and 2) in the fuse box (Fig. 167,3).
- Loosen the detent on the power supply device and unplug the connection cable from the socket.
- Loosen the detent on the vehicle, unplug the plug connector and close the cover of the 230 V connection.

8.10 Fuses



- ▶ Only replace defective fuses when the cause of the defect is known and has been remedied.
- ▶ Replace defective fuses only after the power supply has been turned off.
- ▶ Never bridge or repair fuses.
- ▶ Only replace faulty fuses with a new fuse with the same rating.

8.10.1 12 V fuses

The appliances connected to the 12 V power supply in the living area are fused individually. The fuses can be accessed in the driver's cabin, on the batteries, on or next to the transformer and on the appliances.

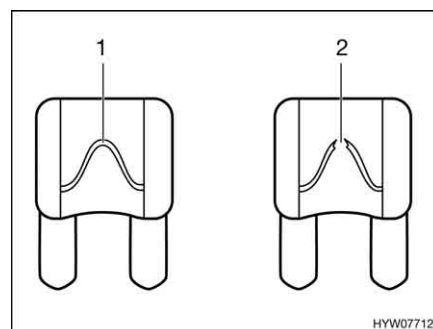

- 1 Unbroken fuse element
- 2 Broken fuse element

Fig. 169 12 V fuse

An intact 12 V fuse can be detected by the unbroken fuse element (Fig. 169,1). If the fuse element is broken (Fig. 169,2), change the fuse.

Before changing fuses, take the function, value and colour of the relevant fuses from the following specifications. When changing fuses, only use flat fuses with the values shown below.

Fuses on the starter battery

The fuses are installed in the footwell in front of the driver's seat below a cover.

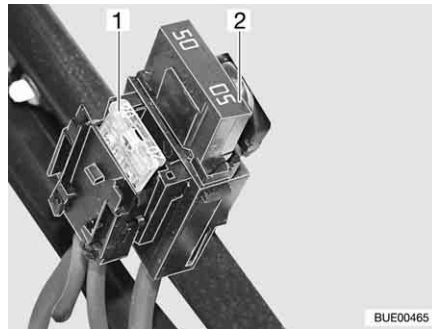

- 1 Flat fuse 20 A/yellow (for the refrigerator)
- 2 Jumbo flat fuse 50 A/red

Fig. 170 Fuses on the starter battery

Fuses on the living area battery

The fuses are fitted next to the living area battery.

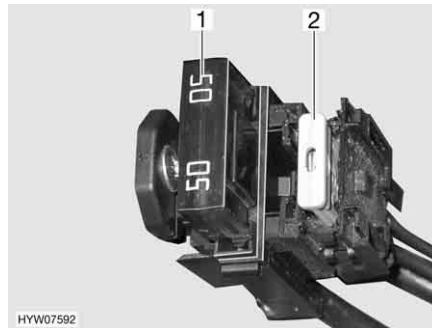

- 1 Jumbo flat fuse 50 A/red (for the transformer/rectifier)
- 2 Flat fuse 2 A/grey (for battery sensor, living area battery)

Fig. 171 Fuses on the living area battery

Fuses on the relay box AD01 Fiat base vehicle

A relay box (AD01) is installed in one of the two seat consoles. The relay box helps generate the signals for the chassis lighting not provided by the base vehicle. The relay box can be used anywhere.

The circuit used by us can vary from the circuit provided by the manufacturer. Consequently, the circuit can also vary from the display on the relay box type plate, which the manufacturer affixed.

FuNo	Function	Value/colour
B2	Cl. 15 (Ignition On)	15 A blue
B3	Cl. 30 (constant position)	15 A blue
B5	D+ Signal	Internal polyswitch (2 A)
B6	Spare	15 A blue
B7	Front side marker lights (white/red)	5 A light brown

Fuses on the transformer/rectifier (EBL 99)

Function	Value/colour
Internal charger module	20 A yellow
Compressor/AES refrigerator	20 A yellow
Heater	10 A red
Basic light/electrically operated entrance step/radio	25 A white
Spare 4	25 A white
Spare 3	25 A white

Function	Value/colour
Spare 2	15 A blue
Spare 1	15 A blue
Solar	15 A blue
Spare 5	15 A blue
Spare 6	15 A blue
Auxiliary charging unit	20 A yellow
Circuit 1	10 A red
Circuit 2	10 A red
TV	10 A red
Water pump	5 A light brown

Fuse for the Thetford toilet (swivel toilet)

The fuse is located in the locker wall of the Thetford cassette.

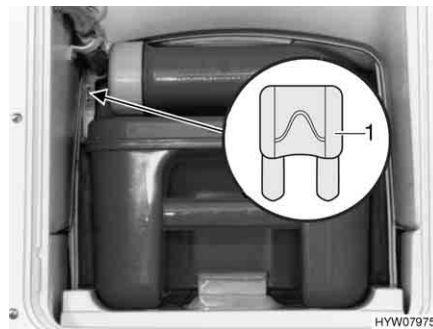

1 Flat fuse 3 A/purple

Fig. 172 Fuse for the Thetford toilet

Changing:

- Open the flap for the Thetford cassette on the outside of the vehicle.
- Pull out the Thetford cassette completely.
- Replace fuse (Fig. 172,1).

Fuse for the Thetford toilet (fixed seat)

The fuse is located in the locker wall of the Thetford cassette.



1 Flat fuse 3 A/purple

Fig. 173 Fuse for the Thetford toilet

Changing:

- Open the flap for the Thetford cassette on the outside of the vehicle.
- Remove the Thetford cassette and swing out the flap in the housing panel.
- Replace fuse (Fig. 173,1).

Fuse for the Dometic toilet

The fuse is located on the rear side of the control unit for the toilet.

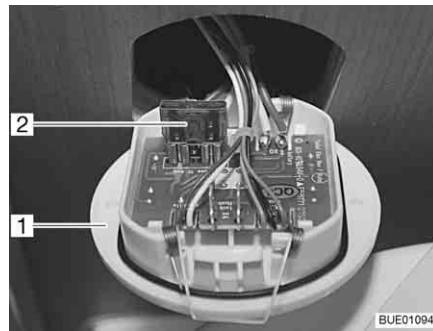

- 1 Control unit
- 2 Flat fuse 10 A/red

Fig. 174 Fuse for toilet

Changing:

- Lift the control unit for the toilet (Fig. 174,1) with a suitable tool and pull it from the wall.
- Replace fuse (Fig. 174,2).

Fuel cell fuse (special equipment)

Two fuses are located next to the living area battery.

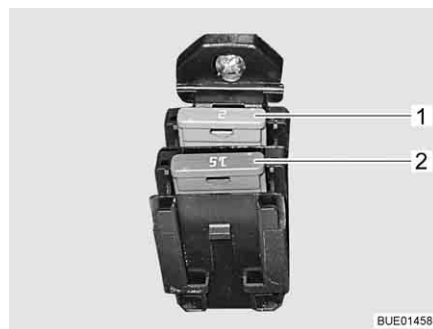

- 1 Flat fuse 2 A/grey
- 2 Flat fuse 15 A/blue

Fig. 175 Fuses for fuel cell

Fuse on the solar charge regulator (special equipment)

The fuse is located on the solar charge regulator.

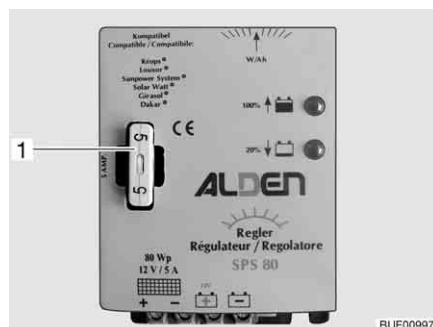

- 1 Flat fuse 5 A/light brown

Fig. 176 Solar charge regulator fuse

Changing:

- Disconnect all 12 V appliances.
- Replace fuse (Fig. 176,1).

8.10.2 230 V fuse



- ▷ Check the fault current protection switch for each connection to the 230 V power supply, at least once every 6 months.



Fig. 177 230 V fuse box with safety cut-out and FI-switch

A fault current protection switch (FI-switch) (Fig. 177,4) in the fuse box (Fig. 177,3) protects the complete vehicle from fault current (0.03 A).

The downstream safety cut-out (10 A) (Fig. 177,2) secures the 230 V sockets, the power supply unit, the auxiliary charging unit and the refrigerator.

For vehicles with special equipment, e.g. air conditioning unit, an additional safety cut-out (16 A) (Fig. 177,1) secures the device.

Position See chapter 16.

Checking fault current protection switch:

- When the vehicle is connected to the 230 V power supply, press the test button (Fig. 177,5). The fault current protection switch (RCD) must be activated.

8.11 External socket (special equipment)

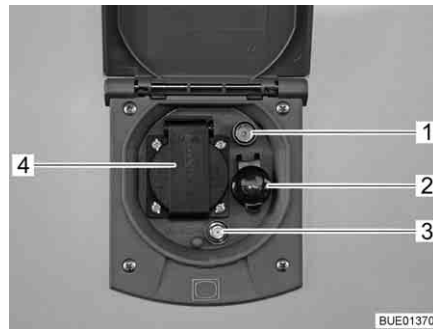

- 1 TV socket
- 2 12 V socket
- 3 SAT socket
- 4 230 V socket

Fig. 178 External socket

The 230 V socket and the 12 V socket can be used to power electrical devices in the awning.

Connection possibilities

TV socket and SAT socket offer various possibilities for TV operation:

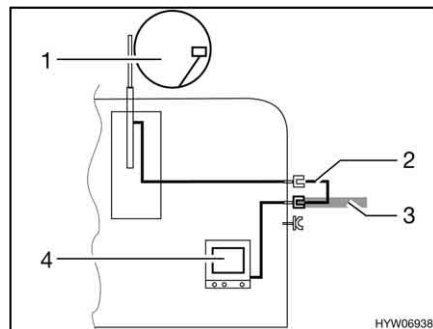

Fig. 179 TV inside the vehicle

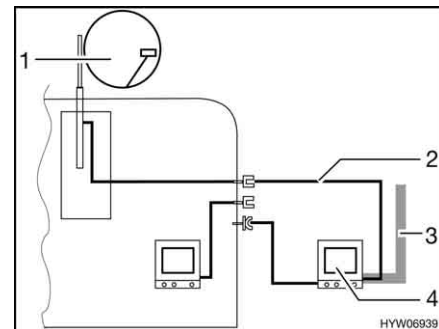

Fig. 180 TV in the awning

- TV inside the vehicle (Fig. 179,4): Connection to roof antenna (Fig. 179,1) with connection cable (Fig. 179,2)
- TV inside the vehicle (Fig. 179,4): Connection to external antenna (Fig. 179,3)
- TV inside the awning (Fig. 180,4): Connection to roof antenna (Fig. 180,1) with connection cable (Fig. 180,2)
- TV inside the awning (Fig. 180,4): Connection to external antenna (Fig. 180,3)

8.12 Circuit diagrams
8.12.1 Circuit diagrams, interior

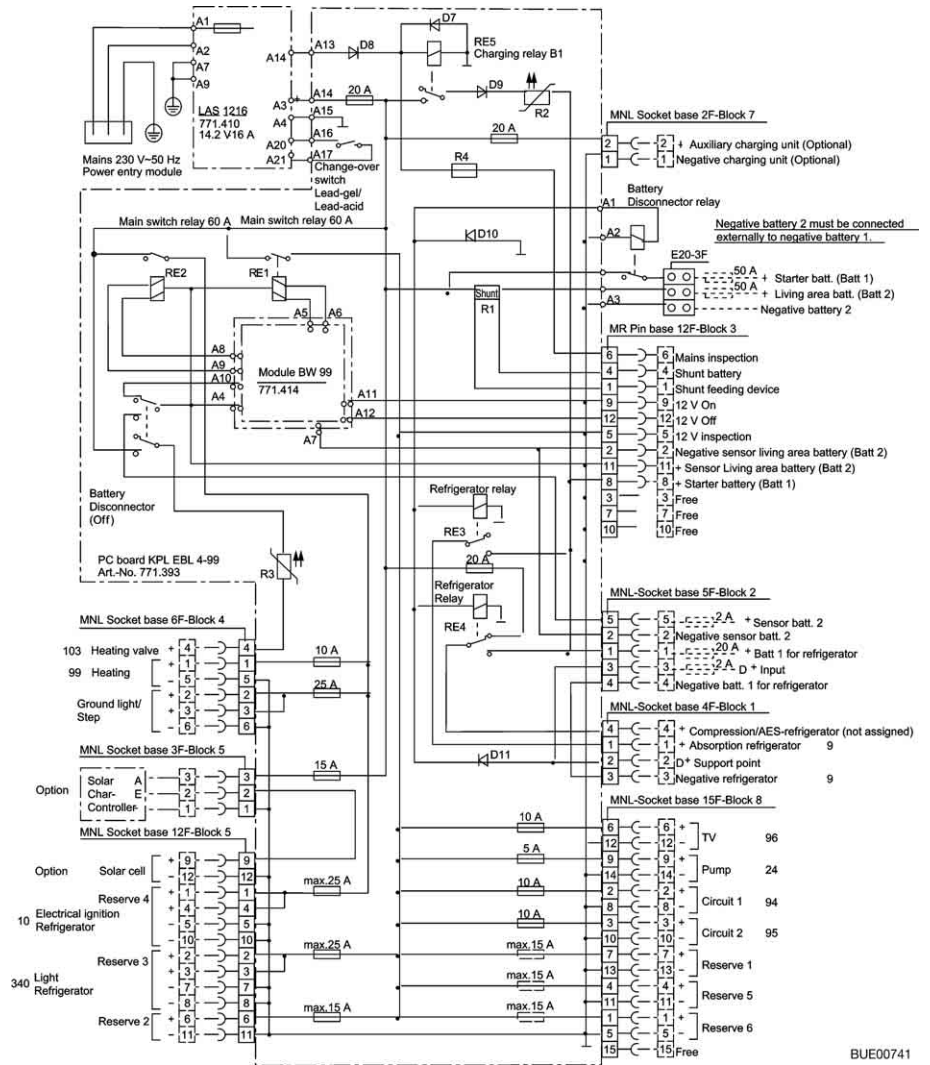

Fig. 181 Circuit diagram, interior (EBL 99)

BUE00741

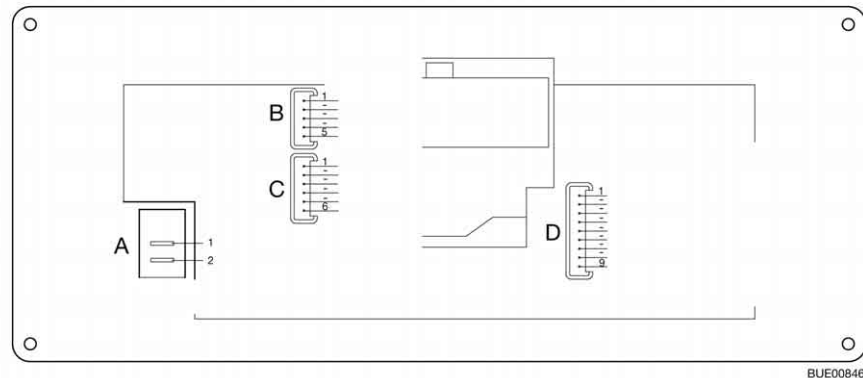

Fig. 182 Block diagram for panel (IT 96-2)

A	2 x AMP flat pins 4.8 x 0.8
1	+ 12 V
2	Pump
B	Lumberg MSFQ 5-pin
1	Full
2	3/4
3	1/2
4	1/4
5	Base waste water tank
C	Lumberg MSFQ 6-pin
1	Full
2	3/4
3	1/2
4	1/4
5	Base water tank
6	n. c.
D	Lumberg MSFQ 9-pin
1	12 V indicator
2	12 V main switch off
3	12 V main switch on
4	+ Starter battery 12 V
5	+ Living area battery sensor
6	Negative living area battery sensor
7	230 V indicator
8	n. c.
9	n. c.

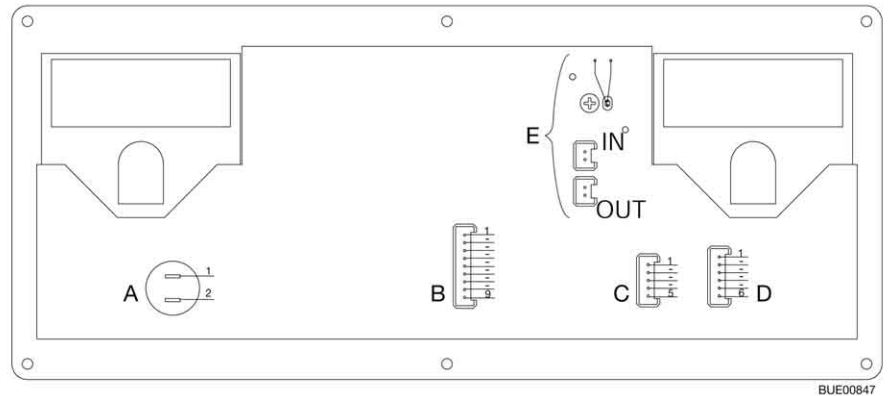

Fig. 183 Block diagram for panel (IT 994)

A	2 x AMP flat pins 4.8 x 0.8
1	+ 12 V
2	Pump
B	Lumberg MSFQ 9-pin
1	12 V indicator
2	12 V main switch off
3	12 V main switch on
4	+ Starter battery 12 V
5	+ Living area battery sensor
6	Negative living area battery sensor
7	230 V indicator
8	Shunt for appliances
9	Shunt battery
C	Lumberg MSFQ 5-pin
1	Full
2	3/4
3	1/2
4	1/4
5	Base waste water tank
D	Lumberg MSFQ 6-pin
1	Full
2	3/4
3	1/2
4	1/4
5	Base water tank
6	n. c.
E	2 x Lumberg MSFQ 2-pin plugs
IN	External internal temperature sensor (optional)
OUT	External temperature sensor
	▷ If an external internal temperature sensor is used, both gray stranded wires of the internal internal temperature sensor are separated.

8.12.2 Circuit diagram, exterior

Fiat

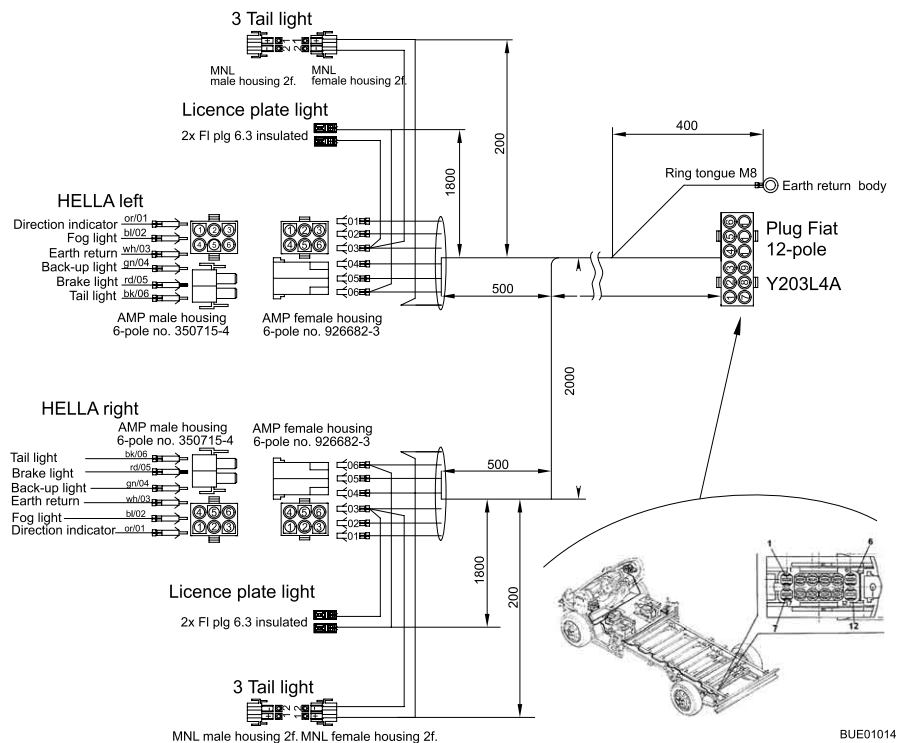

Fig. 184 Circuit diagram, exterior

	Bürstner colours	Connection
Left side	Grey	Left direction indicator
	Blue	Fog tail light
	White	Earth return
	Green	Back-up light
	Red	Brake light
	Black	Left rear light
Right side	Grey	Right direction indicator
	Blue	Fog tail light
	White	Earth return
	Green	Back-up light
	Red	Brake light
	Black	Right rear light

Chapter overview

This chapter contains instructions regarding the appliances of the vehicle.

The instructions refer exclusively to the operation of the appliances.

Further information about the appliances can be found in the instruction manuals for the appliances, included separately with the vehicle.

The instructions address the following topics:

- heater
- air conditioning unit
- boiler
- gas cooker
- gas oven
- microwave oven
- extractor hood
- refrigerator

9.1 General



- ▷ The heat exchanger of the Truma hot-air heater has to be replaced after 30 years. The heat exchanger of the Alde hot-water heater has to be replaced after 10 years. Only the manufacturer of the heater or an authorised specialist workshop is allowed to replace the heat exchanger. The operator of the heater must see to it that the parts are replaced.
- ▷ For safety reasons, spare parts for pieces of heating appliances must correspond with manufacturer's instructions and be permitted by the manufacturer as a spare part. These spare parts may only be fitted by the manufacturer or an authorised specialist workshop.



- ▷ Further information can be obtained in the instruction manual for the respective appliance.

The heater, air conditioning unit, boiler, cooker and refrigerator are fitted depending on the model of the vehicle.

In this instruction manual a description is given only for the operation of the appliances and their particular features.

To operate gas appliances, first open the regulator tap on the gas bottle and the gas isolator tap corresponding to the appliance.

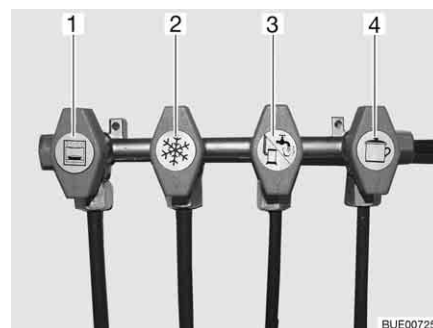

- 1 Oven
- 2 Refrigerator
- 3 Heater/boiler
- 4 Cooker

Fig. 185 Symbols for the gas isolator taps

9.2 Heater



- ▶ Never let gas escape unburned due to danger of explosion.
- ▶ Never run the heater in gas operation when refuelling, on ferries or in the garage. Danger of explosion!
- ▶ Never operate the heater in gas operation in closed spaces (e.g. garages). Danger of poisoning and suffocation!
- ▶ The waste gas vent may neither be closed nor blocked.
- ▶ Do not use the space behind the heater as a storage compartment.



- ▷ The circulation fan of the hot-air heater automatically goes on when the hot-air heater is activated and is automatically switched off and on during operation by means of a thermostat control. This puts an immense strain on the living area battery, if the vehicle is connected to an external 230 V power supply. Take into consideration that the living area battery only has limited reserves of energy.

Initial start-up

When lighting the heater for the first time a small amount of smoke and odour will occur. Immediately set the operating switch of the heater to its highest position. Open doors and windows and ventilate well. Smoke and odour will disappear by themselves after a while.

9.2.1 Models with waste gas vent on the right-hand side of the vehicle



- ▶ If the awning is put up and the heater is running in gas operation, exhaust gases from the heater can escape into the awning area. Danger of suffocation! Make sure the area is sufficiently ventilated.

9.2.2 To heat properly

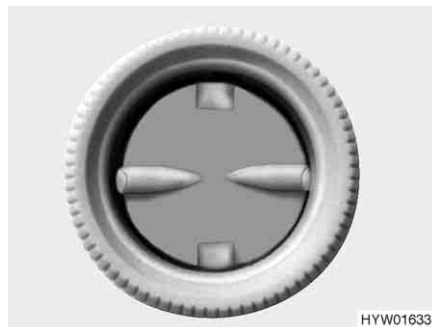

Fig. 186 Air outlet nozzle

Hot air distribution

Several air outlet nozzles (Fig. 186) are built into the vehicle. Pipes conduct the warm air to the air outlet nozzles. Turn the air outlet nozzles in a suitable position so the air can escape as required. To avoid draft close the air outlet nozzles on the dashboard and set the air distribution of the base vehicle to air circulation.

Adjusting the air outlet nozzles

- Fully open: Full hot air stream
- Half or partially open: Reduced hot air stream

When five air outlet nozzles are completely opened, less warm air escapes through each nozzle. However, if only three air outlet nozzles are opened, more warm air flows out of each nozzle.

9.2.3 Truma Combi hot-air heater



- ▷ When there is a danger of frost the heater is not in operation, empty the heating system.

Depending on the equipment, different heaters are installed in the vehicles. The heaters differ with regard to the energy type with which they can be operated.

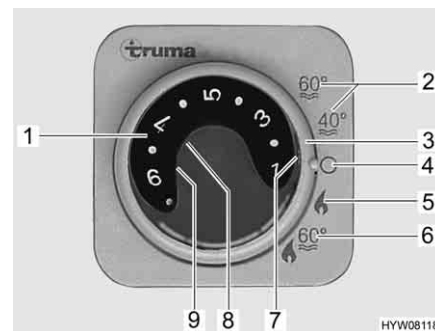

- 1 Temperature control knob
- 2 Summer operation water temperature 40 °C or 60 °C
- 3 Rotary switch
- 4 Off
- 5 Winter operation "Heater without boiler"
- 6 Winter operation "Heater and boiler"
- 7 Green indicator lamp "Heating operation"
- 8 Red indicator lamp "Fault"
- 9 Yellow indicator lamp "Boiler heating-up phase"

Fig. 187 Operating unit for heater/boiler

Operating modes

All heaters have two operating modes:

- Winter operation
- Summer operation

It is only possible to heat the vehicle in the "Winter" operating mode. With the "Summer" operating mode only water in the boiler is heated. It is not possible to heat the vehicle in this operating mode.

Selecting operating mode:

- Set the operating mode using the rotary switch (Fig. 187,3).

The power supply of the heater cannot be interrupted by means of the 12 V main switch.

Variant: Heater with gas operation

The heater is operated exclusively with gas.

Winter operation

The heater selects the necessary burner setting according to the required room temperature. When the required room temperature is reached, the burner is switched off. In "Heater and boiler" operating mode (Fig. 187,6) water in the boiler is also heated. In the operating mode "Heater without boiler" (Fig. 187,5) the heater can be operated with an empty boiler.

Switching on:

- Open the regulator tap on the gas bottle and the gas isolator tap "Heater/boiler".
- Turn the temperature control knob (Fig. 187,1) on the operating unit to the desired heating level.
- Set rotary switch (Fig. 187,3) to winter operation "Heater without boiler" (Fig. 187,5) or to winter operation "Heater and boiler" (Fig. 187,6).

Green indicator lamp (Fig. 187,7) is on.

The circulation fan automatically switches on when the heater is activated.

Switching off:

- Set the rotary switch (Fig. 187,3) to "O" (Fig. 187,4).
- Close the gas isolator tap "Heater/boiler" and the regulator tap on the gas bottle.

After switching off the heater, the circulation fan may still run for a moment to use up the residual heat.

Summer operation

It is not possible to heat the vehicle in "Summer" operating mode. In "Summer" operating mode, only the water in the boiler is heated.

Variant: Heater with gas and 230 V electrical operation



- ▷ 230 V electrical operation is only possible when the vehicle is connected to the 230 V power supply.
- ▷ Select the output level for 230 V electrical operation so that it corresponds to the fuse protection of the 230 V connection (900 W for 3.9 A fuse, 1800 W for 7.8 A fuse).
- ▷ When the heater on the operating unit is set to summer operation and the energy selector switch is set to mixed operation, the heater still runs only in 230 V operation. The gas burner is not switched on.

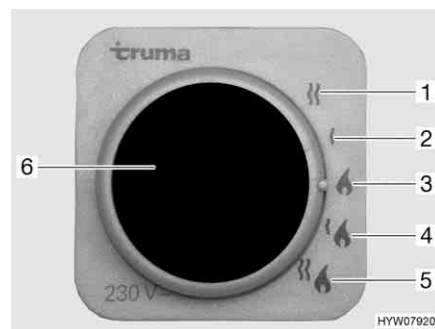

- 1 230 V electrical operation (1800 W)
- 2 230 V electrical operation (900 W)
- 3 Gas operation
- 4 Gas and 230 V electrical operation (900 W)
- 5 Gas and 230 V electrical operation (1800 W)
- 6 Yellow indicator lamp "230 V electrical operation"

Fig. 188 Energy selector switch for heater/boiler

The heater can be operated with different types of energy:

- Gas operation (Fig. 188,3)
- 230 V electrical operation with the output levels 900 W (Fig. 188,2) or 1800 W (Fig. 188,1)
- Gas and 230 V electrical operation (mixed operation) with the output levels 900 W (Fig. 188,4) or 1800 W (Fig. 188,5)

The combination gas operation and 230 V electrical operation reduces the heating-up time (only possible when the heater is set to winter operation at the operating unit (Fig. 187)).

When 230 V electrical operation is selected, the yellow indicator lamp illuminates (Fig. 188,6).



- ▷ Further information can be obtained in the manufacturer's instruction manual.
- ▷ For further information about the use of the boiler see section "Boiler".

9.2.4 Truma Combi hot-air heater D



- ▶ Take the device out of operation by removing the fuse and contact customer service if one of the following events occurs: Long lasting, strong development of smoke; unusual combustion noises; smell of fuel; continuous fault shut-down with error message (blink code).



- ▷ The heater is powered with diesel fuel from the fuel tank of the base vehicle. The heater is not approved for operation with biodiesel (PME, RME, AME).
- ▷ During heating, do not empty the fuel tank down to the reserve mark of the fuel gauge in order to avoid air entering the supply lines.
- ▷ Operate the heater every 4 weeks for approx. 10 minutes in order to prevent a blockage of moving parts.
- ▷ When there is a danger of frost the heater is not in operation, empty the heating system.

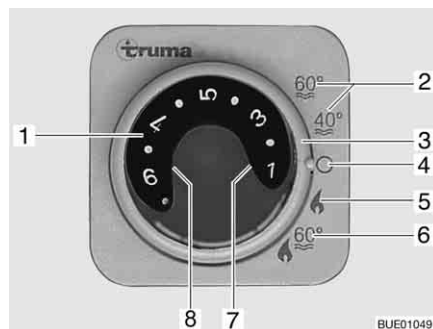

- 1 Temperature control knob
- 2 Summer operation water temperature 40 °C or 60 °C
- 3 Rotary switch
- 4 Off
- 5 Winter operation "Heater without boiler"
- 6 Winter operation "Heater and boiler"
- 7 Green indicator lamp "Heating operation"
- 8 Yellow indicator lamp "Boiler heating phase" or red indicator lamp "Fault"

Fig. 189 Operating unit for heater/boiler

Operating modes

All heaters have two operating modes:

- Winter operation
- Summer operation

It is only possible to heat the vehicle in the "Winter" operating mode. With the "Summer" operating mode only water in the boiler is heated. It is not possible to heat the vehicle in this operating mode.

Selecting operating mode:

- Set the operating mode using the rotary switch (Fig. 189,3).

The power supply of the heater cannot be interrupted by means of the 12 V main switch.

Winter operation

The heater selects the necessary burner setting according to the required room temperature. When the required room temperature is reached, the burner is switched off. The room temperature is measured by the temperature sensor next to the panel. In "Heater and boiler" operating mode (Fig. 189,6) water in the boiler is also heated. In the operating mode "Heater without boiler" (Fig. 189,5) the heater can be operated with an empty boiler.

Switching on:

- Turn the temperature control knob (Fig. 189,1) on the operating unit to the desired temperature range.
- Set rotary switch (Fig. 189,3) to winter operation "Heater without boiler" (Fig. 189,5) or to winter operation "Heater and boiler" (Fig. 189,6).

Green indicator lamp (Fig. 189,7) comes on and indicates at the same time the selected temperature range.

When the boiler is filled, the yellow indicator lamp (Fig. 189,8) indicates the water heating phase.

The circulation fan automatically switches on when the heater is activated.

Switching off: ■ Set the rotary switch (Fig. 189,3) to "O" (Fig. 189,4).

After switching off the heater, the circulation fan may still run for a moment to use up the residual heat.

Summer operation

It is not possible to heat the vehicle in "Summer" operating mode. In "Summer" operating mode, only the water in the boiler is heated.



▷ Further information can be obtained in the manufacturer's instruction manual.

9.2.5 Alde hot-water heater (special equipment)



- ▷ Never run hot-water heater without heating fluid. Observe notes in chapter 12.
- ▷ Never drill holes in the floor. This might damage the hot-water pipes.



- ▷ The circulating pump must always be turned on when the hot-water heater is in operation.
- ▷ We recommend to bleed the heating system after the initial heater operation and to check the glycol content. Observe notes in chapter 12.
- ▷ When the heater is turned on, it starts with the last settings used.
- ▷ For further information, see the separate manufacturer's instruction manual and observe the maintenance instructions found in chapter 12.
- ▷ For further information about the use of the boiler see section "Boiler".

The hot-water heater is installed at the bottom of the wardrobe or under the beds.

The hot-water heater can be operated with the following energy sources:

Operating unit

The operating unit is divided into two sections:

- Display (touch screen)
- Control buttons

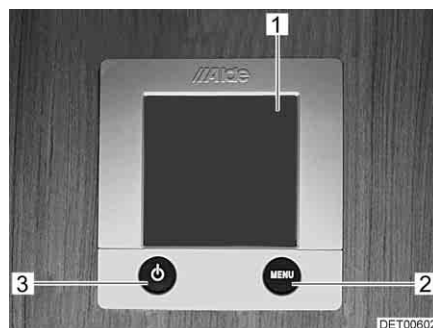

- 1 Display (touch screen)
- 2 "Menu" button
- 3 On/Off button

Fig. 190 Operating unit for hot-water heater



- ▷ When no button is pressed, the operating unit automatically switches to home position after two minutes.
- ▷ Changes to the settings are saved automatically after 10 seconds.

Control buttons

The control buttons have the following functions:

Pos. in Fig. 190	Button	Function
2	MENU	Open adjustment menu
3		Activate heating

Display

The display (Fig. 190,1) is designed as a touch screen. Touching the symbols calls up the relevant function.

Start screen

The Start screen appears on the display after the heater is switched on. The Start screen contains the following information:

Symbol	Signification
	This symbol appears when the circulating pump is activated
	This symbol appears when a switching facility for gas cylinders is activated
	This symbol appears when a voltage of 230 V is present at the heater
	The internal temperature is displayed next to this symbol
	The external temperature is displayed next to this symbol if an external sensor is fitted

Adjustment menu

The "MENU" button calls up the adjustment menu. The meanings of the individual symbols are described in the following table.

The values can be increased or reduced via the "+" or "-" symbols.

Symbol	Signification
	Set the desired temperature of +5 °C to +30 °C
	Set the water temperature in the boiler
	Set the heat output in electrical operation
	Activate the function "Heating in gas operation"
	Call up the enabling menu for the tool menus

Tool menus

The various heater functions can be called up and adjusted via the tool menus. The arrow symbols are used to change between the menus. The meanings of the individual symbols are described in the manufacturer's instruction manual.

Selecting the operating mode

The hot-water heater can be operated with the following energy sources:

- Gas operation
- 230 V electrical operation
- Gas and 230 V electrical operation

The operating mode is selected from the operating unit.

Selecting gas operation:

- Press the "On" button next to the "△" symbol. The gas operation is activated.

Selecting 230 V electrical operation:



- Press the "+" button next to the "⚡" symbol until the desired heat output is reached.
- ▷ Select the output level during 230 V electrical operation in such a way that it corresponds to the 230 V connection protection:
 - Level 1 (1050 W) at 6 A
 - Level 2 (2100 W) at 10 A
 - Level 3 (3150 W) at 16 A

Selecting gas and 230 V electrical operation:



- Select gas operation and 230 V electrical operation on the operating unit.
- ▷ If gas and 230 V electrical operation is selected and if the vehicle is connected to the 230 V power supply, then the hot-water heater at first only operates in 230 V electric operation. Only if the heat output is insufficient does the gas operation also automatically switch on.
- ▷ The gas operation is only possible when the regulator tap on the gas bottle and the gas isolator tap are opened.
- ▷ 230 V electrical operation is only possible when the vehicle is connected to the 230 V power supply.

When the heater is turned on, it starts with the last set operating mode.

Switching on the heater:

- Press "⏻" button. The Start screen appears in the display. The heater starts automatically.

Switching the heater off:

- Press "⏻" button. The heater is turned off.

Setting the rotational speed of the circulating pump



- ▷ The hot-water heater is equipped with a very powerful pump. In smaller vehicles, the pump can only be operated at full power if the pipes are bled. Otherwise, this will increase wear; loud operating noises are the result.



Fig. 191 Speed reduction

The rotational speed of the circulating pump can be set with the control knob (Fig. 191,2). At a lower rotary speed, the operating sounds of the pump are quieter.

The control knob is located on the circulating pump (Fig. 191,1).

Setting the output:

- Turn the control knob (Fig. 191,2) in an anticlockwise direction. The output is reduced.
- Rotate the control knob in a clockwise direction. The output is increased.

**Alde heat exchanger
(special equipment)**



- ▷ The heat exchanger only works when the vehicle engine is running.
- ▷ If the heat exchanger is not being used (as in the summer), the heat exchanger on the stopcock should be shut off.

The heat exchanger can be used to heat the living area of the vehicle during travel without operating the hot-water heater in the living area.

The heat exchanger is connected to the vehicle engine's cooling circuit and thus has the same function as the vehicle heater.

Heat output is set with the living area's heating regulator.

The heat exchanger stopcock is located directly on the exchanger.



Fig. 192 Alde heat exchanger

Turning on:

- Set stopcock handle (Fig. 192,1) parallel to the pipe.

Shutting off:

- Set drain cock handle (Fig. 192,1) at a right angle to the pipe.

Position

The heat exchanger is installed in the rear bench seat of the central seating group.

Alde auxiliary circulating pump (special equipment)



- ▷ The auxiliary circulating pump works only if the heat exchanger has been installed and started, and the hot-water heater is running.

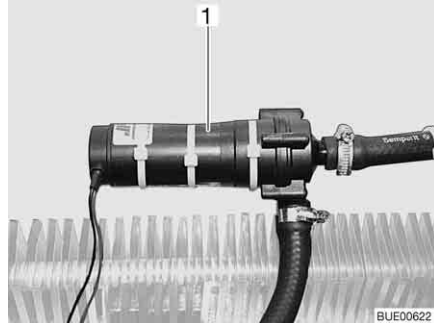

Fig. 193 Auxiliary circulating pump

The auxiliary circulating pump (Fig. 193,1) can be used to heat the vehicle engine when parked.

The auxiliary circulating pump is connected to the vehicle engine's cooling circuit and thus functions as an engine heater.

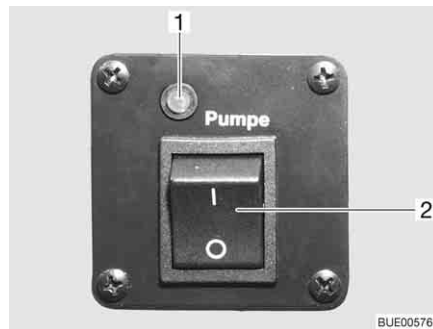

Fig. 194 Operating switch for auxiliary circulating pump



Fig. 195 Operating switch for auxiliary circulating pump (alternative)

The auxiliary circulating pump switch (Fig. 194,2 or Fig. 195) is located next to the hot-water heater operating unit. The yellow indicator lamp (Fig. 194,1) illuminates when the pump is operated.

9.2.6 Auxiliary heat exchanger (partially special equipment)



- ▷ The fan on the auxiliary heat exchanger can be used for ventilation.
- ▷ The heat output is continuously adjusted.

The auxiliary heat exchanger is built into the bench seat.

The auxiliary heat exchanger may be used to provide the vehicle's living area with additional heat during the journey.

The auxiliary heat exchanger is integrated into the heat circulation of the base vehicle and is therefore only in operation when the vehicle engine is running.



Fig. 196 Operating controls for auxiliary heat exchanger

- Switching on:**
- Push the sliding regulator (Fig. 196,1) of the flow control downward to the desired position. The water circulation is open.
 - Turn the fan switch (Fig. 196,2) for the circulation fan in a clockwise direction.
- Switching off:**
- Turn the fan switch (Fig. 196,2) to "0".
 - Push the sliding regulator (Fig. 196,1) of the flow control upward as far as it goes.

9.2.7 Electrical floor warming unit (special equipment)



- ▶ On models with electrical floor warming unit, never drill holes in the floor or screw in any screws. Careful with sharp objects. There is danger of a power cut or a short circuit due to damage to a heater wire.



- ▶ Do not cover the transformer. Danger of overheating!



- ▶ The electrical floor warming unit only operates if the vehicle is connected to the 230 V power supply.
- ▶ The output of the electrical floor warming unit alone is not sufficient to heat the living area.



Fig. 197 Transformer for electrical floor warming unit



Fig. 198 Switch for electrical floor warming unit

The transformer (Fig. 197,1) for the electrical floor warming unit is installed either in the bench seat or in the bedding box, depending on the model.

Switching on:

- Connect the vehicle to the 230 V power supply (see chapter 8).
- Press the rocker switch (Fig. 198,2). The indicator lamp (Fig. 198,1) on the switch is illuminated.

Switching off:

- Press the rocker switch (Fig. 198,2). The indicator lamp (Fig. 198,1) on the switch goes off.

After switching off, the floor remains warm for a while, due to residual heat.
If the transformer is overloaded, the overload protection is actuated. The pin (Fig. 197,2) jumps out.

Switching on overload protection:

- Press the pin (Fig. 197,2) on the overload protection when the transformer is cooled.

9.2.8 Independent vehicle heater (special equipment)



- ▶ Do not operate the heater in closed spaces. Danger of suffocation!
- ▶ Do not operate the heater at petrol stations. Danger of explosion!

The inside and the engine can be heated with the independent vehicle heater. The heating of the engine can be switched off.

The independent vehicle heater can be turned on and off manually or with a timer. The time for the heating to start can be exactly preselected from 1 minute to 24 hours. It is possible to program three switching on times, of which only one can be activated. The maximum permitted operation time is 60 minutes.

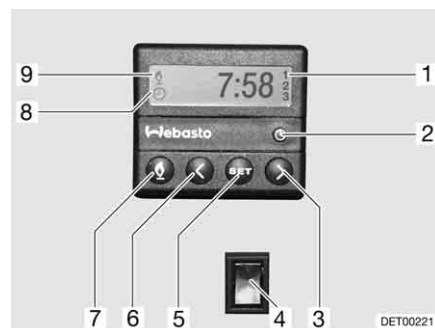

Fig. 199 Operating unit for independent vehicle heater

Switching on manually:

- Press the button (Fig. 199,7). The heating mode is displayed by the symbol (Fig. 199,9). The fan will only be switched on when there is a coolant temperature of 30 °C.

Switching off manually:

- Press the button (Fig. 199,7). The symbol (Fig. 199,9) goes off.

Switching on the engine heating:

- Press the lower part of the switch (Fig. 199,4). Engine is preheated. The fan is switched on immediately.

Switching off the engine heating:

- Press the upper part of the switch (Fig. 199,4). Engine stays cold.

- Setting the time:*
- Press the button (Fig. 199,2). The time setting is displayed by the symbol (Fig. 199,8).
 - Set the time with the buttons (Fig. 199,3 and 6).

- Programming heating start:*
- Press the button (Fig. 199,5).
 - Set the switching on time within ten seconds, with the buttons (Fig. 199,3 and 6).

- Selecting programmed switching on time:*
- Keep pressing the button (Fig. 199,5) until the selected programme number (Fig. 199,1) appears in the display.

9.3 Air conditioning unit (special equipment)

9.3.1 Dometic



- ▷ If the unit is operating, always open at least one ventilation flap.



- ▷ In the winter, vehicle heating can be supported but not replaced by the air conditioning unit.
- ▷ Also read the manufacturer's instruction manual.

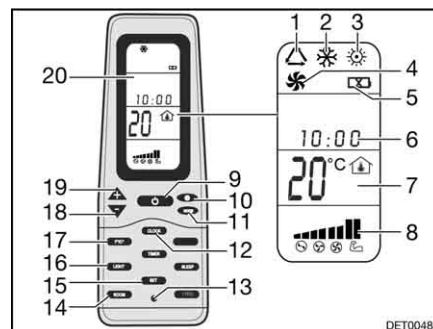

Fig. 200 Remote control

- 1 Symbol for automatic mode
- 2 Symbol for cold mode
- 3 Symbol for warm mode
- 4 Symbol for ventilation mode
- 5 Symbol for discharged batteries
- 6 Time
- 7 Temperature display
- 8 Fan speed display
- 9 ON/OFF button
- 10 Fan speed button
- 11 "MODE" button
- 12 "CLOCK" button
- 13 Reset key
- 14 Interior temperature display button "ROOM"
- 15 Store button "SET"
- 16 Light button "LIGHT"(optional)
- 17 Temperature unit change button "F/C"
- 18 Temperature decrease button "-"
- 19 Temperature increase button "+"
- 20 Display

To execute the individual switching commands, always point the remote control in the direction of the ceiling unit.

Operating modes

The air conditioning unit has the following operating modes:

- Automatic
- Ventilation, manual
- Cooling, manual
- Heating, manual

- Switching on:*
- Press the ON/OFF button (Fig. 200,9).
 - Press the "Mode" button (Fig. 200,11) as often as required until the required mode (Fig. 200,1, 2, 3 or 4) is indicated on the display (Fig. 200,20).

- Use the "+" (Fig. 200,19) and "-" (Fig. 200,18) buttons to set the desired temperature.
- Use the fan speed button (Fig. 200,10) to select the desired fan level.

Switching off:

- Press the ON/OFF button (Fig. 200,9).



Fig. 201 Air conditioning unit (Dometic)

LED The LED (Fig. 201,4) on the ceiling unit (Fig. 201,1) displays the operating status of the air conditioning unit:

Status LED	Signification
Off	Air conditioning unit off
Orange	Air conditioning unit ready to operate
Green	Air conditioning unit in operation
Red (continuous)	No 230 V power connection
Red (flashes once intermittently)	Fault in the interior temperature gauge
Red (flashes twice intermittently)	Fault in the exterior temperature gauge

Air current

The air current can be directed in different directions. The distribution of the air current toward the front or back is continuously adjustable.

Adjusting air current:

- Align the two deflectors (Fig. 201,3 and 5) in the desired position.
- Rotate knob (Fig. 201,2) on sliding regulator in an anticlockwise direction. The sliding regulator for air distribution is released.
- Slide the sliding regulator forwards or backwards to the desired position. The side on which the sliding regulator is located is closed.
- Turn the knob tight in the clockwise direction.

9.3.2 Telair



- ▷ Always wait at least 2 minutes between switching off and switching on again. Otherwise the compressor will be damaged.
- ▷ If the unit is operating, always open at least one ventilation flap.



- ▷ The air conditioning unit only runs if the vehicle is connected to a 230 V power supply.
- ▷ In the winter, vehicle heating can be supported but not replaced by the air conditioning unit.



- ▷ Following switch-on the air conditioning unit needs approx. 3 minutes until the compressor starts to run and cold air or hot air is output.
- ▷ Also read the manufacturer's instruction manual.

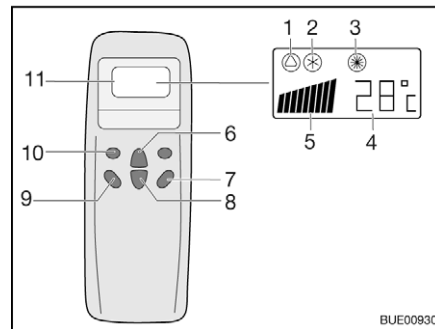

- 1 Symbol for automatic
- 2 Symbol for cooling
- 3 Symbol for heater
- 4 Temperature (set) display
- 5 Fan speed display
- 6 Temperature increase button
- 7 "ON/OFF" button
- 8 Temperature reduction button
- 9 Ventilation speed button
- 10 "Mode" button
- 11 Display

Fig. 202 Remote control

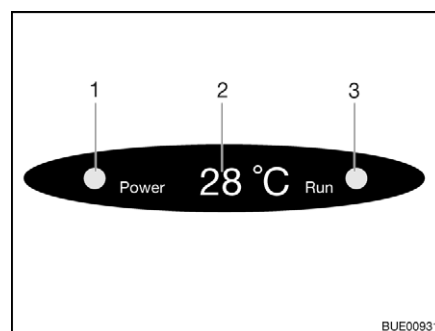

- 1 Mains connection indicator lamp
- 2 Temperature (current) display
- 3 Mode indicator lamp
- Green: Cooling
- Red: Heater

Fig. 203 Display on the diffuser

To execute the individual switching commands, always point the remote control in the direction of the receiver.

Operating modes

- Automatic
- Cooling
- Heater

Switching on:

- Press the "ON/OFF" button (Fig. 202,7).
- Press the "Mode" button (Fig. 202,10) as often as required until the required mode (Fig. 202,1, 2 or 3) is indicated on the display. The corresponding indicator lamp on the diffuser display (Fig. 203,3) lights up.
- Use the temperature increase button (Fig. 202,6) or temperature reduction button (Fig. 202,8) to set the required temperature.
- Use the ventilation speed button (Fig. 202,9) to select the required ventilation level.

Switching off:

- Press the "ON/OFF" button (Fig. 202,7).



- ▷ If the air conditioning unit has run in heating mode, the blower will run on for some minutes in order to dissipate the heat completely.

9.4 Boiler



- ▶ Never let gas escape unburned due to danger of explosion.
- ▶ Never run the boiler in gas operation when refuelling, on ferries or in the garage. Danger of explosion!
- ▶ Never operate the boiler in gas operation in closed spaces (e.g. garages). Danger of poisoning and suffocation!
- ▶ The water in the boiler can be heated up to 65 °C. Risk of scalding!



- ▷ Never use boiler when empty.
- ▷ If the boiler is not being used, empty it if there is any risk of frost.
- ▷ Only operate the boiler with the maximum temperature setting if you require a large quantity of warm water. This protects the boiler against the build-up of limescale.



- ▷ Do not use the water from the boiler as drinking water.

9.4.1 Models with waste gas vent on the right-hand side of the vehicle



- ▶ If the awning is put up and the boiler is running in gas operation, exhaust gases from the boiler can escape into the awning area. Danger of suffocation! Make sure the area is sufficiently ventilated.

9.4.2 Truma Combi boiler

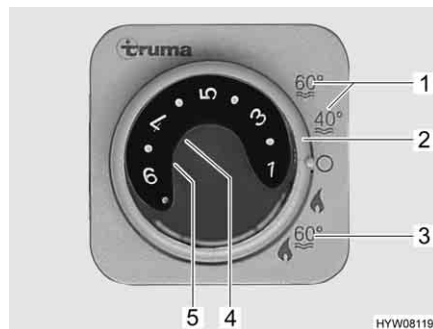

- 1 Summer operation water temperature 40 °C or 60 °C
- 2 Rotary switch
- 3 Winter operation "Heater and boiler"
- 4 Red indicator lamp "Fault"
- 5 Yellow indicator lamp "Boiler heating-up phase"

Fig. 204 Operating unit for heater/boiler

The boiler is integrated into the heater and is operated with gas (gas operation) or with gas and/or electricity (gas and 230 V electrical operation). The boiler is switched on by turning the rotary switch (Fig. 204,2) on the operating unit (Fig. 204). The type of energy is pre-selected (gas and 230 V electrical operation) with the energy selector switch (Fig. 206).

In winter operation "Heater and boiler" (Fig. 204,3) the water is automatically heated up when the heater is switched on. If the heater switches off after the required room temperature has been reached, the boiler will continue to heat up until the set water temperature has been reached.

In summer operation (Fig. 204,1) only the water in the boiler is heated up to either 40 °C or 60 °C. The water is heated to 60 °C in approx. 25 minutes. The yellow indicator lamp (Fig. 204,5) illuminates during the boiler heating-up period.

The power supply for the appliance cannot be interrupted by means of the 12 V main switch. When there is a fault, the red indicator lamp (Fig. 204,4) on the operating unit illuminates (see chapter 14).

Safety/drainage valve

The boiler is equipped with a safety/drainage valve (Fig. 205). The safety/drainage valve prevents water in the boiler from freezing, when there is frost and the heater is not switched on.



- ▷ When the vehicle is not used for a long period of time, open the safety/drainage valve and empty the boiler.
- ▷ At temperatures below 2 °C the safety/drainage valve opens automatically. Only if the temperature of the safety/drainage valve lies above 6 °C can it be shut again.
- ▷ The water pump and the water fittings are not protected against freezing by the safety/drainage valve.



- ▷ The drainage neck of the safety/drainage valve has to be free of dirt (e.g. leaves, ice) at all times.



Fig. 205 Safety/drainage valve of the boiler

Position See chapter 16.

Variant: Boiler with gas operation

The boiler is operated exclusively with gas.

Winter operation

In the "heater and boiler" switch setting in winter operation, the boiler is already switched on.

Summer operation

In summer operation the water can be heated up to 40 °C or 60 °C.

Switching on:

- Open the regulator tap on the gas bottle and the gas isolator tap "Heater/boiler".
- Set the rotary switch (Fig. 204,2) on the operating unit (Fig. 204) to "Summer operation" (Fig. 204,1).

The yellow indicator lamp (Fig. 204,5) is illuminated during the heating up period. When the set water temperature is reached, the period of heating up is finished and the yellow indicator lamp fades.

Switching off:

- Set the rotary switch (Fig. 204,2) on the operating unit (Fig. 204) to "O".
- Close the gas isolator tap "Heater/boiler" and the regulator tap on the gas bottle.

**Variant: Boiler with gas
and 230 V electrical
operation**

- ▷ 230 V electrical operation is only possible when the vehicle is connected to the 230 V power supply.
- ▷ Select the output level for 230 V electrical operation so that it corresponds to the fuse protection of the 230 V connection (900 W for 3.9 A fuse, 1800 W for 7.8 A fuse).
- ▷ When the boiler on the operating unit is set to summer operation and the energy selector switch is set to mixed operation, the boiler still runs only in 230 V operation. The gas burner is not switched on.

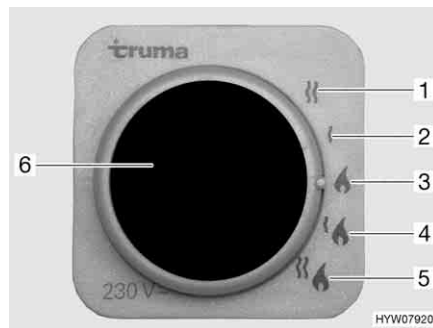

- 1 230 V electrical operation (1800 W)
- 2 230 V electrical operation (900 W)
- 3 Gas operation
- 4 Gas and 230 V electrical operation (900 W)
- 5 Gas and 230 V electrical operation (1800 W)
- 6 Yellow indicator lamp "230 V electrical operation"

Fig. 206 Energy selector switch for heater/boiler

The boiler can be operated with different types of energy:

- Gas operation (Fig. 206,3)
- 230 V electrical operation with the output levels 900 W (Fig. 206,2) or 1800 W (Fig. 206,1)
- Gas and 230 V electrical operation (mixed operation) with the output levels 900 W (Fig. 206,4) or 1800 W (Fig. 206,5)

The combination gas operation and 230 V electrical operation reduces the heating-up time (only possible when the boiler is set to winter operation at the operating unit (Fig. 204)).

When 230 V electrical operation is selected, the yellow indicator lamp illuminates (Fig. 206,6).

Filling/emptying the boiler

The boiler can be supplied with water from the water tank.

Filling the boiler with water:

- Switch on 12 V power supply on the panel.
- Close the safety/drainage valve. Turn the knob (Fig. 205,1) perpendicular to the safety/drainage valve and push the push button (Fig. 205,2) in.
- Set all the water taps to "Hot" and open them. The water pump is turned on. The warm water pipes are filled with water.
- Keep the taps open until the water flowing out of the taps has no bubbles in it. This is the only way to ensure that the boiler is full of water.
- Close all water taps.

Emptying the boiler:

- Set the rotary switch (Fig. 204,2) on the operating unit (Fig. 204) to "0".
- Open the safety/drainage valve. To do this turn the knob (Fig. 205,1) parallel to the safety/drainage valve. The push button (Fig. 205,2) jumps out. The boiler is drained to the outside by the safety/drainage valve.
- Check whether the water has been drained completely from the boiler (approx. 12 litres).



▷ Further information can be obtained in the manufacturer's instruction manual.

9.4.3 Truma Combi boiler D



▶ Take the device out of operation by removing the fuse and contact customer service if one of the following events occurs: Long lasting, strong development of smoke; unusual combustion noises; smell of fuel; continuous fault shut-down with error message (blink code).

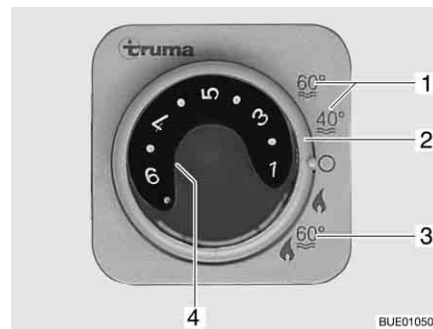

- 1 Summer operation water temperature 40 °C or 60 °C
- 2 Rotary switch
- 3 Winter operation "Heater and boiler"
- 4 Yellow indicator lamp "Boiler heating phase" or red indicator lamp "Fault"

Fig. 207 Operating unit for heater/boiler

The boiler is integrated in the heater and is powered with diesel fuel from the fuel tank. The boiler is switched on by turning the rotary switch (Fig. 207,2) on the operating unit (Fig. 207).

In winter operation "Heater and boiler" (Fig. 207,3) the water is automatically heated up when the heater is switched on. If the heater switches off after the required room temperature has been reached, the boiler will continue to heat up until the set water temperature has been reached.

In summer operation (Fig. 207,1) only the water in the boiler is heated up to either 40 °C or 60 °C. The water is heated to 60 °C in approx. 25 minutes. The yellow indicator lamp (Fig. 207,4) illuminates during the boiler heating-up period.

The power supply for the appliance cannot be interrupted by means of the 12 V main switch. When there is a fault, the red indicator lamp (Fig. 207,4) on the operating unit illuminates (see chapter 14).

Safety/drainage valve

The boiler is equipped with a safety/drainage valve (Fig. 208). The safety/drainage valve prevents water in the boiler from freezing, when there is frost and the heater is not switched on.



- ▷ When the vehicle is not used for a long period of time, open the safety/drainage valve and empty the boiler.
- ▷ At temperatures below 2 °C the safety/drainage valve opens automatically. Only if the temperature of the safety/drainage valve lies above 6 °C can it be shut again.
- ▷ The water pump and the water fittings are not protected against freezing by the safety/drainage valve.



- ▷ The drainage neck of the safety/drainage valve has to be free of dirt (e.g. leaves, ice) at all times.



Fig. 208 Safety/drainage valve of the boiler

Position See chapter 16.

Winter operation In the "Heater and boiler" switch setting in winter operation, the boiler is already switched on.

Summer operation In summer operation the water can be heated up to 40 °C or 60 °C.

Switching on: ■ Set the rotary switch (Fig. 207,2) on the operating unit (Fig. 207) to "Summer operation" (Fig. 207,1).

The yellow indicator lamp (Fig. 207,4) is illuminated during the heating up period. When the set water temperature is reached, the period of heating up is finished and the yellow indicator lamp fades.

Switching off: ■ Set the rotary switch (Fig. 207,2) on the operating unit (Fig. 207) to "O".

Filling/emptying the boiler The boiler can be supplied with water from the water tank.

Filling the boiler with water:

- Switch on 12 V power supply on the panel.
- Switch on the water pump power supply at the panel, if necessary.
- Close the safety/drainage valve. Turn the knob (Fig. 208,1) perpendicular to the safety/drainage valve and press the button (Fig. 208,2) in.
- Set all the water taps to "Hot" and open them. The water pump is turned on. The warm water pipes are filled with water.
- Keep the taps open until the water flowing out of the taps has no bubbles in it. This is the only way to ensure that the boiler is full of water.
- Close all water taps.

Emptying the boiler:

- Switch off the water pump power supply at the panel, if necessary.
 - Set the rotary switch (Fig. 207,2) on the operating unit (Fig. 207) to "O".
 - Set all the water taps to "Hot" and open them.
 - Open the safety/drainage valve. To do this turn the knob (Fig. 208,1) parallel to the safety/drainage valve. The snap fastener (Fig. 208,2) jumps out. The boiler is drained to the outside by the safety/drainage valve.
 - Check whether the water has been drained completely from the boiler (approx. 10 litres).
- ▷ Further information can be obtained in the manufacturer's instruction manual.



9.4.4 Alde boiler (special equipment)

Switching the boiler on/off

The boiler is integrated in the hot-water heater. A separate operation is not possible. For operating the hot-water heater, see section 9.2.5.

Filling/emptying the boiler

The boiler can be supplied with water from the water tank.



- ▷ Depending on the model, the vehicle is fitted with one or two drain cocks.

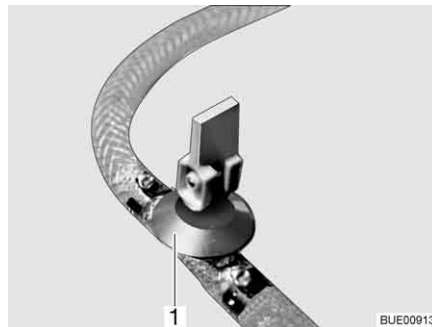

Fig. 209 Drain cock

Filling the boiler with water:

- Close the drain cock(s). Position the rocking lever (Fig. 209,1) horizontally.
- Switch on 12 V power supply on the panel.
- Set all the water taps to "Hot" and open them. The water pump is turned on. The warm water pipes are filled with water.
- Keep the taps open until the water flowing out of the taps has no bubbles in it. This is the only way to ensure that the boiler is full of water.
- Close all water taps.

Emptying the boiler:

- Switch off boiler.
- Open all water taps and set to the central position.
- Open drain cock(s) (Fig. 209). To do so, set the rocking lever (Fig. 209,1) in a vertical position. The boiler is drained to the outside.
- Check whether the water has been drained completely from the boiler (approx. 10 litres).



- ▷ For further information, see the separate manufacturer's instruction manual and observe the maintenance instructions found in chapter 12.

Position of the drain cock(s)

See chapter 16.

9.5 Cooker



- ▶ Never let gas escape unburned due to danger of explosion.
- ▶ Before using the cooker make sure that there is sufficient ventilation. Open windows or the skylight.
- ▶ Do not use gas cooker or gas oven for heating.
- ▶ Do not fit any curtains in the immediate proximity of the cooker. Fire hazard!
- ▶ Always protect your hands with cooking gloves or potholders when handling hot pots, pans and similar items. There is a risk of injury.

9.5.1 Gas cooker



- ▶ During activation and operation of the gas cooker, no flammable objects or highly inflammable objects such as dishcloths, napkins etc. must be near the gas cooker. Fire hazard!
- ▶ The process of ignition must be visible from above and must not be covered by cooking pans placed on the cooker.
- ▶ If there is a flame protection, always put it up when using the gas cooker.
- ▶ Depending on the model, the gas cooker lid is held closed by a spring. When closing there is danger of getting injured!



- ▷ Do not place hot objects such as cooking pans on the sink cover. The plastic can become deformed.
- ▷ Do not use the glass gas cooker lid as a hob.
- ▷ Do not close the gas cooker lid while the gas cooker is in operation.
- ▷ Do not apply pressure on the gas cooker lid when it is closed.
- ▷ Do not place hot cooking pans on the gas cooker lid.
- ▷ Keep the gas cooker lid open after cooking until the burners are cool. Otherwise the glass plate could shatter.



- ▷ Only use pots and pans whose diameter is appropriate for the gas cooker burners.
- ▷ When the flame goes out, the thermocouple automatically cuts the gas supply.
- ▷ Further information can be obtained in the device manufacturer's instruction manual.

The vehicle kitchen unit is fitted with a three-burner gas cooker.

The operating controls for the gas cooker are located directly at the gas cooker.

Manual ignition

The gas cooker must be lit manually.

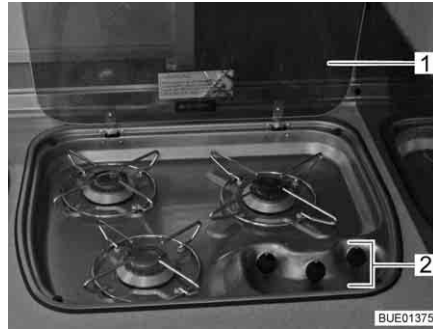

Fig. 210 Gas cooker

Switching on:

- Open the regulator tap on the gas bottle and the gas isolator tap "Cooker".
- Open the gas cooker lid (Fig. 210,1).
- Turn the control knob (Fig. 210,2) on the burner you wish to use to the ignition position (large flame).
- Press the control knob down and hold it.
- Light the burner with a gas lighter, a match or other suitable means of lighting.
- Once the flame is burning, the control knob must be held down for 10 to 15 seconds, until the thermocouple automatically keeps the gas supply open.
- Release the control knob and turn to the desired setting.
- If ignition is unsuccessful, repeat the entire procedure.

Switching off:

- Turn the control knob to the 0-position. The flame fades.
- Close the gas isolator tap "Cooker" and the regulator tap on the gas bottle.

Automatic ignition

The gas cooker is equipped with electronic ignition.



Fig. 211 Operating controls for gas cooker

Switching on:

- Open the regulator tap on the gas bottle and the gas isolator tap "Cooker".
- Open the gas cooker lid.
- Depending on the model, fold out and lock the flame protection.
- Turn the control knob (Fig. 211,1) on the burner you wish to use to the ignition position (large flame).
- Press the control knob down and hold it.
The automatic ignition produces ignition sparks. A clicking noise can be heard.

- Once the flame is burning, the control knob must be held down for 10 to 15 seconds, until the thermocouple automatically keeps the gas supply open.
- Release the control knob and turn to the desired setting.

Switching off:

- Turn the control knob to the 0-position. The flame fades.
- Close the gas isolator tap "Cooker" and the regulator tap on the gas bottle.

9.5.2 Gas oven (Dometic) (special equipment)



- ▶ Keep the ventilation openings on the gas oven open at all times.
- ▶ There must be no flammable objects near the gas oven when it is being lit.
- ▶ If ignition has not taken place, repeat the entire procedure. If necessary, check if there is gas and/or current in the gas oven.
- ▶ If the gas oven still does not work, close the gas isolator tap and notify your service centre.
- ▶ If the burner flame is accidentally extinguished, turn the control knob to "0" and leave the burner off for at least 1 minute. Then ignite it again.
- ▶ Parts of the gas oven become very hot during operation. Never touch hot parts with bare hands.
- ▶ Place the meals, wire rack and drip pan into the gas oven so that they do not come into contact with the flame.
- ▶ Only ignite the oven and grill when the oven door is open.
- ▶ Always leave the oven door half open when grilling.
- ▶ Do not use the grill for longer than 25 minutes.



- ▷ There are two different versions of the gas oven, depending on the model. Although their appearance is not identical, operation is the same for both.
- ▷ Depending on the model the gas oven may come equipped with a grill.
- ▷ Before using the gas oven for the first time run it for 30 minutes at maximum temperature without any contents.
- ▷ When the flame goes out, the thermocouple automatically cuts the gas supply.
- ▷ A safety switch prevents ignition when the oven door is closed.
- ▷ If the ignition procedure fails repeatedly, turn the control knob to "0". Wait at least 1 minute and then ignite the gas oven manually. If necessary, check if there is gas and/or current in the gas oven. If the gas oven still does not work, close the gas isolator tap and notify your service centre.
- ▷ Further information can be obtained in the manufacturer's instruction manual.

The gas oven is equipped with electronic ignition.



Fig. 212 Gas oven (Dometic TecTower)



Fig. 213 Gas oven (Dometic)

The meaning of the symbols on the control knobs (Fig. 212,1 and Fig. 213,1) of the two gas ovens is identical:

- and mean oven
- and mean grill.

Switching the oven on:

- Open the regulator tap on the gas bottle and the gas isolator tap "Oven".
- Open oven door completely. The safety switch then releases the ignition.
- Press and hold control knob and turn it anti-clockwise to the required setting. Keep control knob pressed for a further 5-10 seconds. Ignition will take place automatically.
- Release control knob.
- Close oven door.

Switching the grill on:

- Open the regulator tap on the gas bottle and the gas isolator tap "Oven".
- Open the oven door to at least the first locking position (approx. 45°).
- Press and hold control knob and turn it clockwise to the grill symbol. Keep control knob pressed for a further 5-10 seconds. Ignition will take place automatically.
- Release control knob.
- ▷ Do not close the oven door when grilling.



Switching off:

- Turn the control knob to "O". The flame fades.
- Close the gas isolator tap "Oven" and the regulator tap on the gas bottle.

9.5.3 Microwave oven (special equipment)



- ▶ Only qualified personnel may repair the microwave oven. Improper repairs can cause major risks to the user.
- ▶ The protection device against the escape of microwave energy should never be removed.
- ▶ Use the microwave oven only if it has been properly installed.
- ▶ Only use the microwave oven when the door seal is free of damage.
- ▶ Never leave the microwave oven unattended when it is in operation.
- ▶ If there is smoke, keep the microwave oven closed, switch it off and interrupt the power supply.



- ▷ Operate the microwave oven only with the rotary plate and the rotary cross in place.
- ▷ Use only crockery suitable for microwave use.



- ▷ The microwave oven only functions with correct 230 V power supply. In the case of fluctuations of the voltage or of voltage below 230 V, the microwave oven switches itself off completely. Therefore, do not switch on additional 230 V appliances when the microwave oven is in operation. Particularly in southern countries it happens that the line voltage is described as having 230 V but it really does not amount to this value. So it may happen that the microwave oven cannot be operated in these countries.
- ▷ Further information can be obtained in the manufacturer's instruction manual.



Fig. 214 Operating controls for microwave oven

- Switching on:**
- Press the key (Fig. 214,3) to open the door and place food into the cooking area.
 - Close the door. A clicking noise can be heard when it engages.
 - Select the output on the control knob (Fig. 214,1).
 - Select the cooking time with the control knob (Fig. 214,2). Cooking begins.

The end of the cooking process is signalled by a signal tone. The microwave oven will switch off automatically.

- Switching off:**
- Press the key (Fig. 214,3) to open the door and take out the food.

9.5.4 Extractor hood (special equipment)

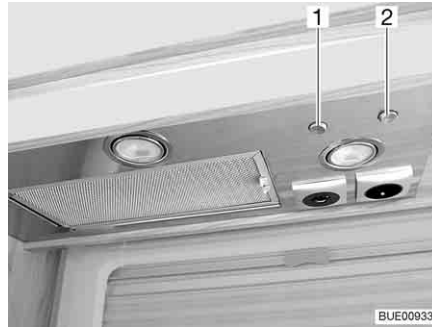

Fig. 215 Extractor hood

The cooking area is equipped with an extractor hood. The powerful fan blows the cooking steam directly outside. To switch on the extractor hood, press the right flip switch (Fig. 215,2).

Use the left flip switch (Fig. 215,1) to switch on the two lights in the extractor hood.

9.6 Refrigerator

During the journey, only operate the refrigerator via the 12 V power supply. At high ambient temperatures the refrigerator is unable to reach its full cooling power. At high external temperatures, the full cooling power of the cooling unit is only guaranteed if the refrigerator is ventilated sufficiently. In order to achieve a better ventilation the refrigerator ventilation grill can be removed.



- ▷ When leaving the vehicle, always mount the refrigerator ventilation grill. Otherwise water can enter during rain.
- ▷ The cooling power of the refrigerator depends on the vehicle setup. The cooling power can decrease if the vehicle is inclined by 5° or more. Therefore, always park the vehicle on level ground.
- ▷ Absorption refrigerators operate at normal room temperature (approx. 21 °C) within the specified temperature range. At significantly higher ambient temperatures (> 30 °C), the cooling power is reduced. This is because the "evaporating temperature" of the refrigerant is lower in absorption refrigerators than it is in compressor refrigerators.

9.6.1 Refrigerator ventilation grill

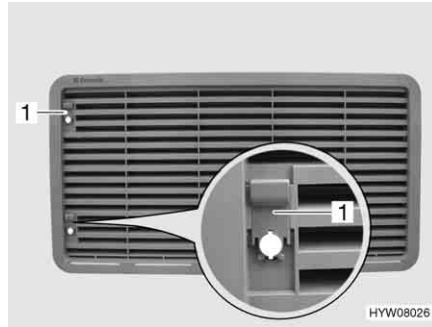

Fig. 216 Refrigerator ventilation grill (with sliding trap)



Fig. 217 Refrigerator ventilation grill (with screw)

- Removal:**
- Depending on the design, push the sliding trap (Fig. 216,1) upwards or turn the screw (Fig. 217,1) a quarter turn using a coin.
 - Remove refrigerator ventilation grill.

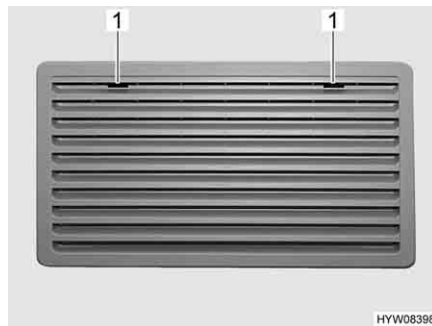

Fig. 218 Refrigerator ventilation grill (Thetford large)

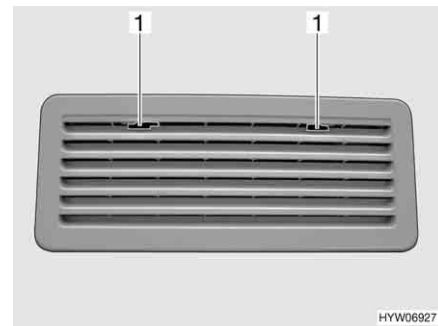

Fig. 219 Refrigerator ventilation grill (Thetford small)

- Removal:**
- Move the locking device (Fig. 218,1 or Fig. 219,1) to the middle.
 - Remove refrigerator ventilation grill.

9.6.2 Operation (Dometic 8 series with manual power selection MES)

Operating modes The refrigerator has 3 operating modes:

- Gas operation
- 230 V AC
- 12 V DC

The operating mode is set with the operating controls on the refrigerator panel.



- ▷ Select only one energy source.
- ▷ The refrigerator always requires a 12 V control voltage, regardless of which type of energy it is using. The control voltage is present as soon as the transformer/rectifier is switched on. Therefore the closed circuit current always flows even if the refrigerator is switched off. Always switch off the transformer/rectifier for a temporary lay-up.

Gas operation

▶ Never let gas escape unburned due to danger of explosion.

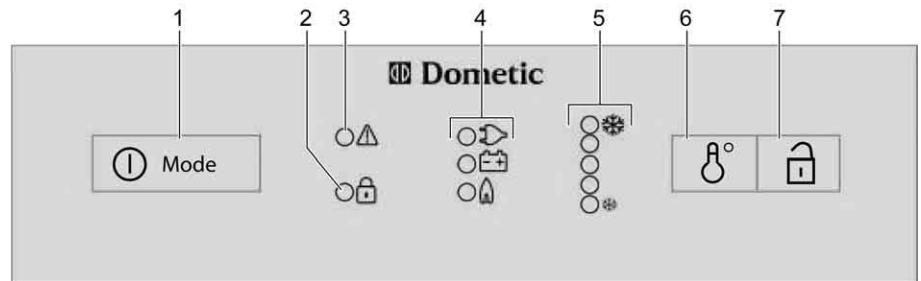

HYW07971

Fig. 220 Operating controls for the refrigerator (Dometic 8 series with MES)

- 1 On/off switch/energy selector switch
- 2 Display-LED "open door" (only for central locking system of the refrigerator door)
- 3 Display-LED "fault"
- 4 Operating indicators
- 5 Display-LED "temperature range"
- 6 Switch for temperature setting
- 7 Door opener (only for refrigerator door central locking system)

Switching on:

- Open the regulator tap on the gas bottle and the gas isolator tap "Refrigerator".
- Press the on/off switch/energy selector switch (Fig. 220,1) down for 2 seconds in order to switch on the appliance. The LED of the operating mode chosen most recently lights up.
- If appropriate press the on/off switch/energy selector switch (Fig. 220,1) until the gas operating indicator "🔥" lights up. Gas supply is open. Ignition will take place automatically. A ticking sound can be heard until ignition has been completed successfully.
- Use switch (Fig. 220,6) to adjust refrigerating temperature.

Switching off:

- Press down the on/off switch/energy selector switch for 2 seconds. Refrigerator is switched off.
- Close the gas isolator tap "Refrigerator" and the regulator tap on the gas bottle.

Electrical operation

▷ Close the gas isolator tap "Refrigerator" when the refrigerator is operated electrically.

The refrigerator can be operated with the following voltages:

- 230 V AC
- 12 V DC

Switching the 230 V operation on:

- Press the on/off switch/energy selector switch (Fig. 220,1) down for 2 seconds in order to switch on the appliance. The LED of the operating mode chosen most recently lights up.
- If appropriate press the on/off switch/energy selector switch (Fig. 220,1) several times until the operating indicator 230 V "" lights up.
- Use switch (Fig. 220,6) to adjust refrigerating temperature.

Switching the 230 V operation off:

- Press down the on/off switch/energy selector switch for 2 seconds. Refrigerator is switched off.

Switching the 12 V operation on:

- Press the on/off switch/energy selector switch (Fig. 220,1) down for 2 seconds in order to switch on the appliance. The LED of the operating mode chosen most recently lights up.
- If appropriate press the on/off switch/energy selector switch (Fig. 220,1) several times until the operating indicator 12 V "" lights up.
- Use switch (Fig. 220,6) to adjust refrigerating temperature.

Switching the 12 V operation off:

- Press down the on/off switch/energy selector switch for 2 seconds. Refrigerator is switched off.

When operated with 12 V, the refrigerator draws power only from the starter battery of the vehicle. The starter battery only supplies the refrigerator with 12 V when the vehicle engine is running. When the vehicle engine is not running, the refrigerator is cut off from the power supply in the living area. For this reason, change over to gas operation during prolonged driving breaks.



▷ Further information can be obtained from the separate instruction manual "Refrigerator".

9.6.3 Operation (Dometic 8 series with automatic power selection AES)

Operating modes

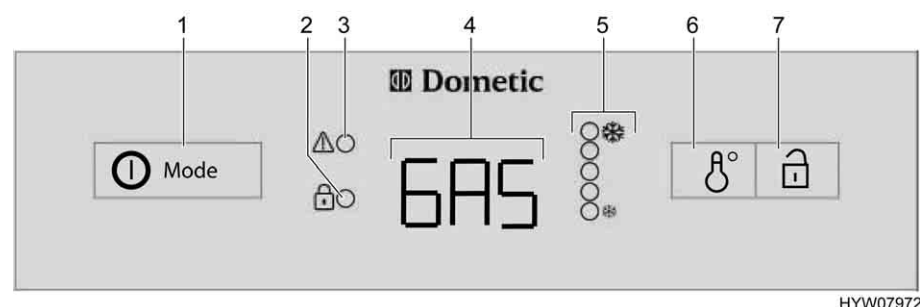

HYW07972

Fig. 221 Operating controls for the refrigerator (Dometic 8 series with AES)

- 1 On/off switch/energy selector switch
- 2 Display-LED "open door" (only for central locking system of the refrigerator door)
- 3 Display-LED "fault"
- 4 Operating indicator
- 5 Display-LED "temperature range"
- 6 Switch for temperature setting
- 7 Door opener (only for refrigerator door central locking system)

The refrigerator is equipped with automatic power selection (AES). If automatic operation (AU) is selected, the AES automatically selects the optimum energy source and regulates the refrigerator operation. Manual intervention to select the type of power is possible but not required.

The AES selects from the following types of power:

- 230 V AC
- Gas
- 12 V DC

Choosing the available energy source highest on the list.

In the case of a fault, the LED display fault will flash "⚠" (Fig. 221,3).



- ▷ The refrigerator always requires a 12 V control voltage, regardless of which type of energy it is using. The control voltage is present as soon as the transformer/rectifier is switched on. Therefore the closed circuit current always flows even if the refrigerator is switched off. Always switch off the transformer/rectifier for a temporary lay-up.

230 V operation

If the automatic mode is selected and the 230 V supply is switched on, the AES selects this energy source first.

12 V operation

If the automatic mode is selected, the AES selects the 12 V operation only if the vehicle engine is running.

Gas operation



- ▶ Never let gas escape unburned due to danger of explosion.



- ▷ Open the regulator tap on the gas bottle and the gas isolator tap "Refrigerator".

If the automatic mode is selected, 230 V power supply is **not** connected and the vehicle's engine is **not running**, the AES selects the gas supply. When selecting gas operation the ignition fuse is opened automatically so gas can get into the burner. At the same time the electronic ignition is activated. If the gas flame is extinguished, e.g. by blast of wind, the ignition is activated immediately and re-ignites the gas. In the case of a fault in gas operation the text "GAS" flashes in the operating indicator (Fig. 221,4).

Change-over between energy sources



- ▶ Open flames are prohibited at petrol stations. If the stop takes longer than 15 minutes, the refrigerator has to be turned off at the energy selector switch.

When changing over from 230 V or 12 V to gas, delay times are built into the AES. For example, when changing over from 12 V operation to gas operation, a 15 minute delay is built in the AES. This prevents a change-over to gas operation when the vehicle is stopped briefly and the engine is switched off (e.g. stop to fill tank).

Refrigerating temperature control

When turned on the first time the refrigerator automatically selects the middle thermostat position. This position can be adjusted manually by using the switch for temperature setting (Fig. 221,6). The indicator LEDs (Fig. 221,5) show the selected thermostat position. The refrigerating temperature for the three types of energy is set with the switch. It takes a few hours till the refrigerator reaches its normal operating temperature. When changing over the operating mode the thermostat setting will be maintained. The refrigerating temperature is retained regardless of the type of power being used.

Manual operation

Switching on:

- Open the regulator tap on the gas bottle and the gas isolator tap "Refrigerator".
- Press the on/off switch/energy selector switch (Fig. 221,1) down for 2 seconds in order to switch on the appliance. The operating mode selected most recently is shown in the operating indicator (Fig. 221,4).
- Select the energy type with the on/off switch/energy selector switch (Fig. 221,1).
- Set the refrigerating temperature on the switch for temperature setting (Fig. 221,6). The indicator LEDs (Fig. 221,5) show the selected thermostat position.

When operated with 12 V, the refrigerator draws power only from the living area battery.



- ▷ If the refrigerator is manually set to "12 V", it will constantly consume current. Therefore, switch over to gas operation when the vehicle engine is **not** running, and the vehicle is **not** connected to the 230 V power supply.

Switching off:

- Press down the on/off switch/energy selector switch (Fig. 221,1) for 2 seconds. All displays close.
- Close the gas isolator tap "Refrigerator" and the regulator tap on the gas bottle.



- ▷ Further information can be obtained from the separate instruction manual "Refrigerator".

9.6.4 Operation (Thetford with SES)



- ▷ Further information can be obtained from the separate instruction manual "Refrigerator".

Operating modes

The refrigerator is equipped with an automatic system to select the type of power (SES). The "SES" automatically selects the optimal energy source and regulates the refrigerator operation. Manual operation to select the type of power is not required.

The SES selects from the following energy sources in the "Automatic" operating mode:

- 230 V AC
- 12 V DC
- Gas

Choosing the available energy source highest on the list.

The previously set operating mode is preselected when the refrigerator is switched on.

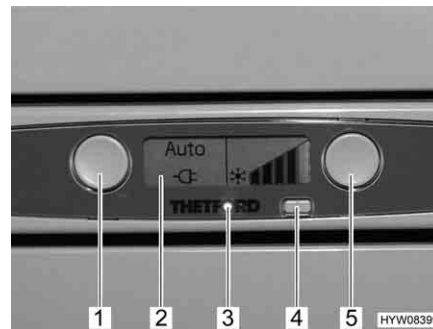

- 1 Operating mode button
- 2 Display
- 3 Operating indicator (blue)
- 4 On/Off button
- 5 Temperature selection button

Fig. 222 Operating controls for the refrigerator (Thetford with SES)

If there is a fault in the energy source that is set, the system switches to the next available energy source. If no other energy source is available, the operating indicator flashes and an error code appears on the display.

230 V operation

If the 230 V power supply is connected, this energy source is selected as the first priority by the SES.

12 V operation

12 V operation is only selected by the "SES" if the vehicle's engine is running and the alternator supplies sufficient 12 V operating voltage.

Gas operation



- ▶ Never let gas escape unburned due to danger of explosion.



- ▷ Open the regulator tap on the gas bottle and the gas isolator tap "Refrigerator".

If the 230 V power supply is disconnected and the vehicle's engine is not running the "SES" selects the gas supply. When selecting gas operation the ignition fuse is opened automatically so gas can get into the burner. At the same time the electronic ignition is activated. If the gas flame is extinguished, e.g. by blast of wind, the ignition is activated immediately and re-ignites the gas.

Change-over between energy sources



- ▶ Open flames are prohibited at petrol stations. If the stop takes longer than 15 minutes, the refrigerator has to be turned off at the On/Off button.

When changing over between the different energy sources there are forced delays built in the "SES". This means, that after a change-over to a new energy source the refrigerator can not be operated immediately. When changing over from 12 V operation to gas operation, a 15-minute delay is built in the SES. This prevents a change-over to gas operation when the vehicle is stopped briefly and the engine is switched off (e.g. stop to fill tank).

Undervoltage operation

During electric operation the "SES" constantly checks the voltage of the power supply. If the voltage is too low over a longer period of time the "SES" automatically switches over to gas operation. The "SES" remains in this operating mode until the voltage is back to normal.

Refrigerating temperature control

When it is switched on, the refrigerator automatically selects the thermostat setting selected last. This setting can be adjusted manually using the temperature selection button (Fig. 222,5). The bars on the display (Fig. 222,2) indicate the selected thermostat position.

The height of the bar indicates the cooling power selected:

- Small bar = low cooling setting
- Tall bar = high cooling setting

The refrigerating temperature for the three types of energy is set with the button. It takes a few hours till the refrigerator reaches the set operating temperature. When changing over the operating mode the thermostat setting will be maintained. The refrigerating temperature is retained regardless of the type of power being used.

Operation

Switching on:

- Press On/Off button (Fig. 222,4). The operating indicator (Fig. 222,3) lights up in blue. All the symbols in the display light up briefly.

You can use the operating mode button (Fig. 222,1) to select automatic mode or a specific energy source. When pressing the button, the operating mode is selected in the following order:

- Automatic power selection (recommended)
- 12 V DC
- Gas
- 230 V AC

The selection is shown on the display.

- Set the refrigerating temperature using the temperature selection button (Fig. 222,5). The bars on the display (Fig. 222,2) indicate the selected thermostat position.

Switching off:

- Press On/Off button (Fig. 222,4). The operating indicator (Fig. 222,3) is no longer lit up.
- Close the gas isolator tap "Refrigerator" and the regulator tap on the gas bottle.



- ▷ Further information can be obtained in the manufacturer's instruction manual.

9.6.5 Refrigerator door locking mechanism

With some models, the refrigerator has a separate freezer compartment. The specifications in this section correspondingly also apply to the door of the freezer compartment.



- ▷ During the journey the refrigerator door must always be closed and locked in the closed position.



- ▷ Lock the refrigerator door in ventilation position when the refrigerator is switched off. This prevents mould forming.

There are two positions for locking the refrigerator door in place:

- Closed refrigerator door during travel and when the refrigerator is in operation
- Slightly opened refrigerator door as a ventilation position when the refrigerator is switched off

Dometic 8 series



Fig. 223 Release button of the refrigerator door (Dometic 8 series)

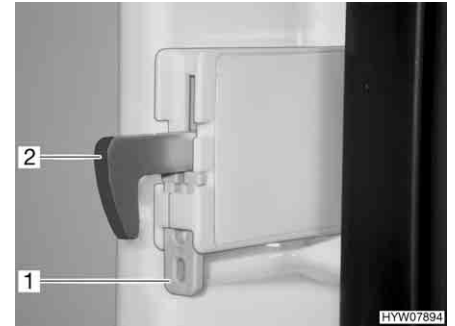

Fig. 224 Lock hook fixture

Opening:

- Press the release button (Fig. 223,1) and open the refrigerator door.

Closing:

- Close the refrigerator door. The lock hook engages audibly.

When the vehicle has been positioned, the lock hook can be fixed. The refrigerator door can now be opened without having to press the release button.

Fixing the lock hook:

- Press the fixture (Fig. 224,1) upwards. The lock hook (Fig. 224,2) is pressed upwards and has no function.

Unlocking the lock hook:

- Push the lock hook (Fig. 224,2) down. The lock hook functions again.

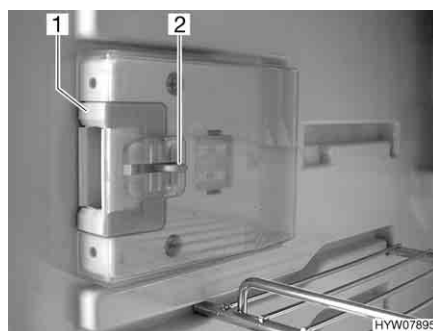

Fig. 225 Locking device in normal position

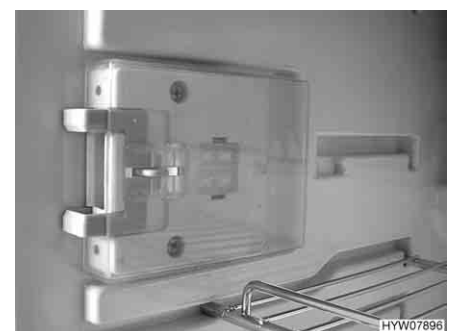

Fig. 226 Locking device in ventilation position

Locking in the ventilation position:

- Open the refrigerator door.
- Press down the unlocking device (Fig. 225,2).
- Push locking device (Fig. 225,1) forwards (Fig. 226).

If the refrigerator door is closed now, a gap will remain between the refrigerator door and the refrigerator.

Thetford

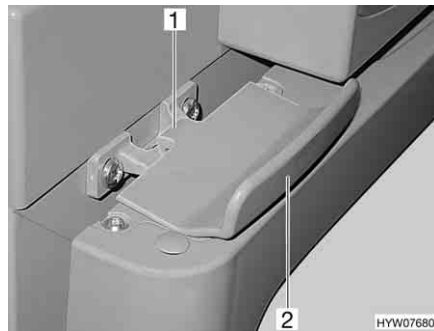

Fig. 227 Lock of refrigerator door, closed (Thetford)

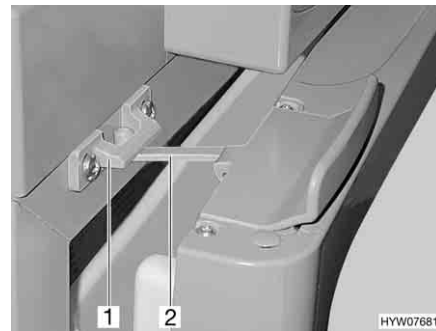

Fig. 228 Refrigerator door in ventilation position (Thetford)

Opening: ■ Open the refrigerator door at the handle (Fig. 227,2). The lock (Fig. 227,1) is released automatically.

Closing: ■ Fully close the refrigerator door. Ensure that the lock is engaged.

Locking in the ventilation position: ■ Slightly open refrigerator door.
 ■ Open the lock (Fig. 228,2) and snap it into the locking catch (Fig. 228,1). The refrigerator door will then stay slightly open.

Chapter overview

This chapter contains instructions regarding the sanitary fittings of the vehicle. The instructions address the following topics:

- water tank
- waste water tank
- waste water tank heater
- complete water system
- toilet compartment
- toilet

10.1 Water supply, general



- ▶ Fill water tank from supply systems that have been verified to provide drinking water quality.
- ▶ Only use such hoses or containers when filling that have been approved for use with drinking water.
- ▶ Thoroughly rinse filling hose or container with drinking water before use (2 to 3 times capacity).
- ▶ Empty filling hose or container completely after use and close openings of the filling hose or container.
- ▶ Water left standing in the water tank or in the water pipes becomes undrinkable after a short period. Therefore, before each use of the vehicle, thoroughly clean the water pipes and the water tank. After each use of the vehicle completely empty the water tank and the water pipes.
- ▶ In the case of lay-ups lasting more than a week disinfect the water system before using the vehicle.



- ▷ If the vehicle is not used for several days or if it is not heated when there is a risk of frost, empty the entire water system. Make certain that the water pump is switched off on the panel. Otherwise, the water pump will overheat and may get damaged. Leave the water taps on in central position. Leave the safety/drainage valve (if there is one) and all drain cocks open. Frost damage to appliances, frost damage to the vehicle and deposits in water-carrying components can be avoided in this way.
- ▷ The water pump will overheat without water and can get damaged. Never operate water pump when the water tank is empty.

The vehicle is equipped with a fitted water tank. An electric water pump pumps the water to the individual water taps. Opening a water tap automatically switches on the water pump and pumps water to the tap.

The waste water tank collects the waste water. The water level in the water and waste water tanks can be checked on the panel.



- ▷ Before the water fittings can be used, the 12 V power supply and water pump on the panel must be turned on. Otherwise the water pump will not work.
- ▷ When the water tank is re-filled, an air bubble may form at the bottom of the pump. This air bubble will prevent water from being drawn in. Shake the water pump up and down energetically in the water.

10.2 Water tank

10.2.1 Volumes



- ▷ The water tank contains 120 litres. However, the volume has been limited to 60 litres (overflow installed) for payload reasons. The panel has not been adjusted to this volume. The level indicator on the panel shows the actual amount of water in the tank.

If necessary or if there is a sufficiently large residual vehicle payload, the water tank can be filled up to its actual capacity. To do this, close overflow. The handle is on the water tank.

10.2.2 Drinking water filler neck with cap

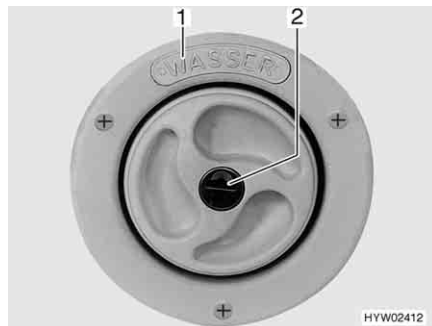

Fig. 229 Cap for the drinking water filler neck

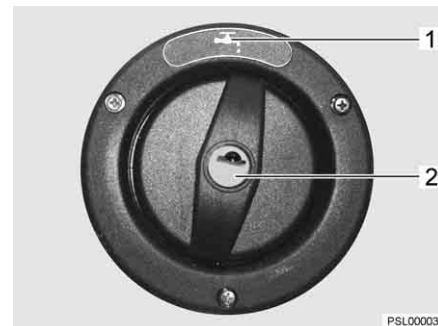

Fig. 230 Cap for the drinking water filler neck (alternative)

The drinking water filler neck is on the right or left side of the vehicle, depending on the model.

The drinking water filler neck is labelled by the word "WASSER" (water) (Fig. 229,1) or marked by the symbol "W" (Fig. 230,1). The cap is open and closed using the key for the external flap locks.

- Opening:**
- Insert key into locking cylinder (Fig. 229,2 or Fig. 230,2) and turn a quarter turn in an anticlockwise direction.
 - Remove cap.
- Closing:**
- Place cap on the drinking water filler neck.
 - Turn key one quarter turn in a clockwise direction.
 - Remove the key.
 - Check that the cap sits firmly on the drinking water filler neck.

10.2.3 Closing/opening the overflow



- ▶ When filling the water tank, observe the maximum permissible gross weight of the vehicle. Luggage must be reduced accordingly when the water tank is full.

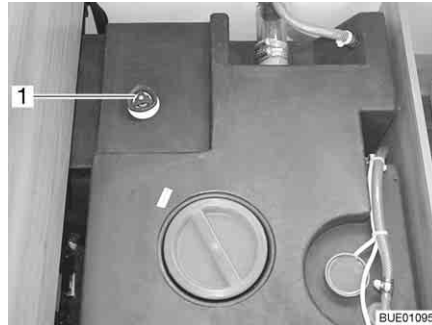

Fig. 231 Water tank with handle

- Closing:*
- Turn the handle (Fig. 231, 1) on the water tank in a clockwise direction as far as it will go.
 - Fill the water tank with drinking water.
- Opening:*
- Turn the handle (Fig. 231, 1) on the water tank in an anticlockwise direction as far as it will go. Excess water will drain away leaving 60 litres in the tank.

10.2.4 Filling with water



- ▶ When filling the water tank, observe the maximum permissible gross weight of the vehicle. Luggage must be reduced accordingly when the water tank is full.

- Open drinking water filler neck.
- Fill the water tank with drinking water. Use a water hose, a water canister with a funnel or similar for filling.
- Close drinking water filler neck.

10.2.5 Draining water (handle with overflow)

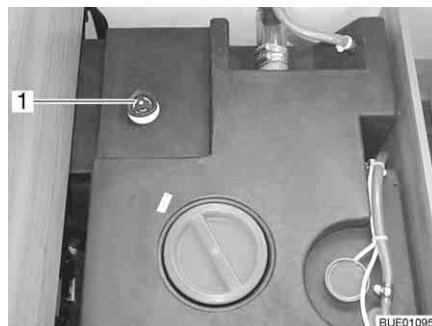

Fig. 232 Water tank with handle

- Turn the handle (Fig. 232, 1) on the water tank in an anticlockwise direction as far as possible beyond the resistance to fully open the drainage opening.

10.3 Waste water tank



- ▷ Never pour boiling water directly into the sink outlet. Boiling water could cause deformation and leaks in the waste water pipe system.



- ▷ Only empty the waste water tank at disposal stations, camping sites or caravan sites especially provided for this purpose.

10.3.1 Draining waste water



- ▷ In case of frost add so much anti-freeze (such as kitchen salt) to the waste water tank so that the waste water cannot freeze.

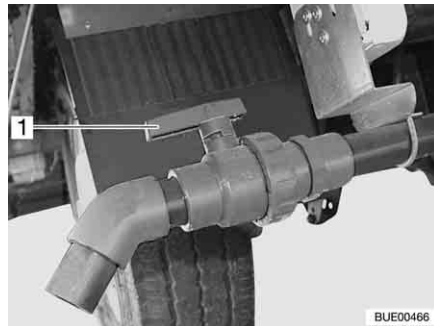

Fig. 233 Drain cock

The waste water tank is in the rear area of the vehicle. It is located underneath the floor of the vehicle.

Waste water from the kitchen and washing unit flows through plastic pipes into the waste water tank.

The drain cock and the cleaning opening are located on the underside of the waste water tank.

The waste water tank holds 90 litres.

Emptying:

- Attach the waste water hose to the drain pipe.
- Turn the handle (Fig. 233,1) of the drain cock in flow direction.
- Completely empty waste water tank.
- Turn the drain cock handle perpendicular to the flow direction.
- Remove the waste water hose.

10.3.2 Waste water tank heater (special equipment)

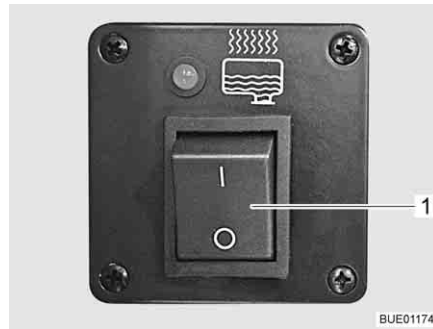

Fig. 234 Operating switch



Fig. 235 Operating switch (alternative)

The waste water tank may be heated and is insulated. The integrated frost guard prevents waste water from freezing.

A switch (Fig. 234,1 or Fig. 235) on the front of the bench seat or bed may be used to switch the frost guard on and off.

The frost guard begins to heat the waste water as soon as the water temperature drops to approx. 5 °C. The frost guard ends the heating process when the waste water reaches a temperature of approx. 10 °C.

10.4 Filling the water system



- ▶ When filling the water tank, observe the maximum permissible gross weight of the vehicle. Luggage must be reduced accordingly when the water tank is full.



- ▷ The water pump will overheat without water and can get damaged. Never operate water pump when the water tank is empty.



- ▷ The Truma system (heater/boiler) has a safety/drainage valve and, depending on the model, one or two drain cocks for emptying.
- ▷ Depending on the model, the Alde system (heater/boiler) has one or two drain cocks for emptying.
- ▷ The water quantity can be monitored on the panel while the water tank is filled.

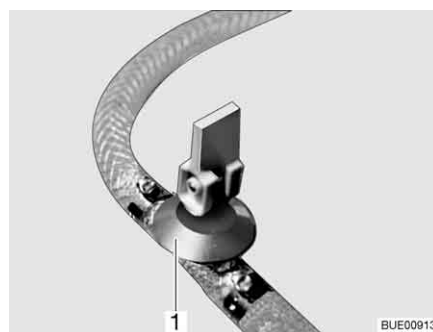

Fig. 236 Drain cock (with rocking lever)

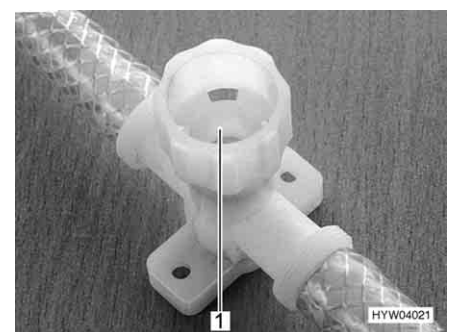

Fig. 237 Drain cock (with twist cap)

- Position the vehicle horizontally.
- Switch on 12 V power supply on the panel.

- If necessary, switch on the water pump on the panel.
- Clean or disinfect water system.
- Close the safety/drainage valve (Truma). Turn the knob perpendicular to the safety/drainage valve and press the push button in.
If the temperature is below 6 °C, the safety/drainage valve cannot be closed. Therefore switch on the living area heater and wait until the temperature of the safety/drainage valve exceeds 6 °C.
- Close all drain cocks. To do this, position the drain cock's rocking lever (Fig. 236,1) horizontally or turn the drain cock's cap (Fig. 237,1) in a clockwise direction.
- Close the drainage opening of the water tank.
- Close all water taps.
- Open the drinking water filler neck on the outside of the vehicle.
- Fill the water tank with drinking water. Use a water hose, a water canister with a funnel or similar for filling.
- Set all the water taps to "Hot" and open them. The water pump is turned on. The warm water pipes are filled with water.
- Keep the taps open until the water flowing out of the taps has no bubbles in it. This is the only way to ensure that the boiler is full of water.
- Set all water taps to "Cold" and leave them open. This will fill the cold water pipes with water.
- Keep the taps open until the water flowing out of the taps has no bubbles in it.
- Close all water taps.
- Close drinking water filler neck.
- Check that the cap on the water tank is not leaking.

Position of the drain cocks and safety/drainage valve

See chapter 16.

10.5 Emptying the water system



- ▷ If the vehicle is not used for several days or if it is not heated when there is a risk of frost, empty the entire water system. Make certain that the water pump is switched off on the panel. Otherwise, the water pump will overheat and may get damaged. Leave the water taps on in central position. Leave the safety/drainage valve (if there is one) and all drain cocks open. Frost damage to appliances, frost damage to the vehicle and deposits in water-carrying components can be avoided in this way.
- ▷ If the water pump can be turned off from the panel, always turn off the water pump from the panel before you empty the water system. Otherwise the water pump runs until it overheats or the battery is empty.



- ▷ The Truma system (heater/boiler) has a safety/drainage valve and, depending on the model, one or two drain cocks for emptying.
- ▷ Depending on the model, the Alde system (heater/boiler) has one or two drain cocks for emptying.

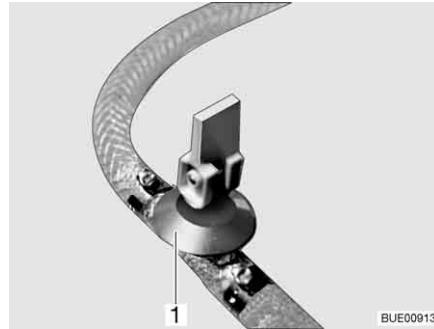

Fig. 238 Drain cock (with rocking lever)

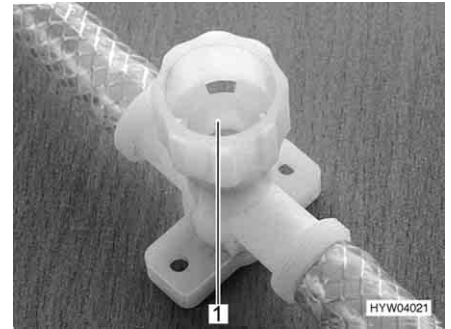

Fig. 239 Drain cock (with twist cap)

To empty and ventilate the water system, proceed as follows. This will avoid frost damage:

- Position the vehicle horizontally.
- Switch off water pump on panel.
- Switch off the 12 V power supply on the panel.
- Shut off the boiler (see section 9.4).
- Open all drain cocks. To do this, position the drain cock's rocking lever (Fig. 238,1) vertically or turn the drain cock's cap (Fig. 239,1) in an anti-clockwise direction.
- Open the safety/drainage valve (Truma). To do this turn the knob parallel to the safety/drainage valve. The push button jumps out.
- Open the water tank drain.
- Open all water taps and set to the central position.
- Hang the shower handset up in the shower position.
- Hold the water pump up until the water pipes are completely empty.
- Check whether the water tank is completely empty.
- Blow out the remaining water in the water pipes (max. 0.5 bar). To do this, remove the pipe from the water pump and blow into the pipe.
- Empty the waste water tank. Take note of the environmental tips in this chapter.
- Empty toilet cassette or sewage tank. Take note of the environmental tips in this chapter.
- Clean the water tank and then rinse it out thoroughly.
- Let the water system dry for as long as possible.
- After emptying, leave all water taps on in the central position.
- Leave all drain cocks open.

Position of the drain cocks and safety/drainage valve

See chapter 16.

10.6 Toilet compartment



- ▷ Do not transport any loads in the shower tray. The shower tray or other items of equipment in the toilet compartment can be damaged.



- ▷ For ventilation purposes during or after a shower, and for drying wet clothing, close the toilet compartment door and open the window or the toilet compartment skylight. This improves the air circulation.
- ▷ Close the shower curtain completely when showering, so that no water is able to enter the area between the wash room wall and the shower tray.
- ▷ After taking a shower, rinse soap residue from the shower tray, otherwise cracks can appear in the shower tray over time.
- ▷ After using the shower, wipe it dry to prevent moisture from collecting.
- ▷ Further information about cleaning the toilet compartment can be found in the section 11.2.

10.7 Toilet



- ▷ If there is any risk of frost and the vehicle is not heated, empty the sewage tank (cassette).
- ▷ Do not sit on the lid of the toilet. The lid is not designed to bear the weight of a person and could break.
- ▷ Use a suitable chemical for this toilet. The ventilation will merely remove the odour but not germs and gases. Germs and gases will have a detrimental effect on the sealing rubbers.
- ▷ Never put the sanitary liquid directly in the toilet bowl.



- ▷ Further information can be obtained in the device manufacturer's instruction manual.



- ▷ Only empty the sewage tank (cassette) at disposal stations, at camping sites or caravan sites, that are especially provided for this purpose.

The flushing of the toilet is fed directly from the water system of the vehicle.

10.7.1 Swivel toilet (Thetford C-200)



- ▷ The Thetford cassette can only be taken out if the sliding trap is closed.

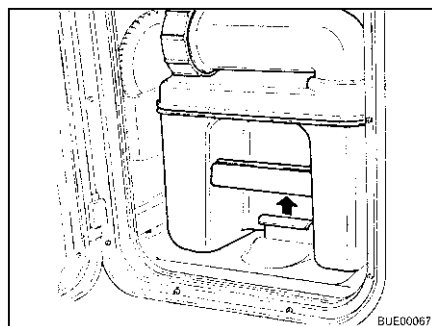

Fig. 240 Pulling the retaining clip

Preparing toilet:

- Open the flap for the Thetford cassette and pull the retaining clip upwards to remove the Thetford cassette.

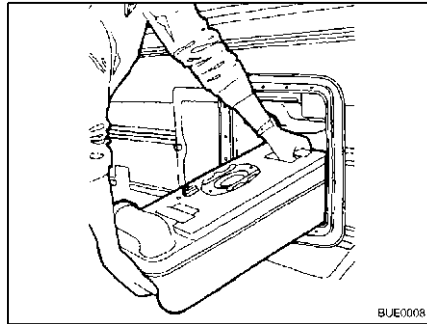

Fig. 241 Removing the Thetford cassette

- Pull out the Thetford cassette as far as it can go.
- Tip the Thetford cassette slightly and then pull it out completely.

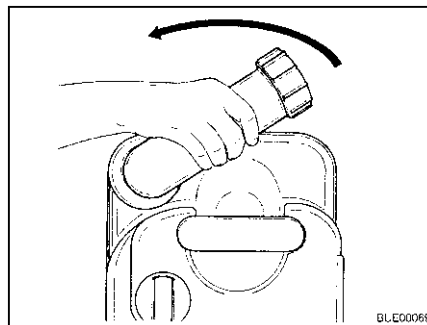

Fig. 242 Turning drainage neck

- Place the Thetford cassette upright.
- Turn the drainage neck upwards.
- Remove the cap of the drainage neck.
- ▷ Never put the sanitary liquid directly in the toilet bowl.

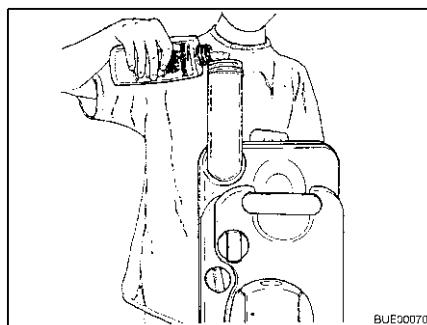

Fig. 243 Filling with sanitary liquid

- Fill the Thetford cassette with the specified quantity of sanitary liquid.
- Then add enough water to completely cover the bottom of the Thetford cassette.
- Close drainage neck with the cap.
- Return the drainage neck to its original position.



- ▷ When inserting, do not use force. The Thetford cassette can be damaged.

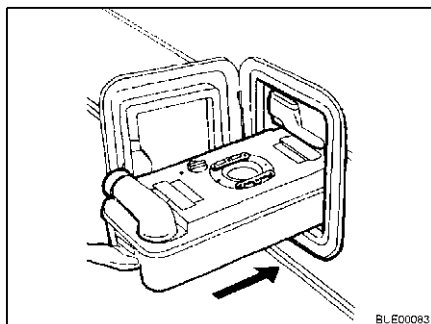

Fig. 244 Inserting the Thetford cassette

- Push the Thetford cassette back to its original position.

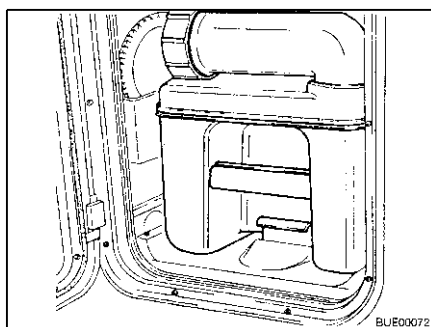

Fig. 245 Thetford cassette secured

- Ensure that the Thetford cassette is secured by the retaining clip.
- Lock the flap for the Thetford cassette.

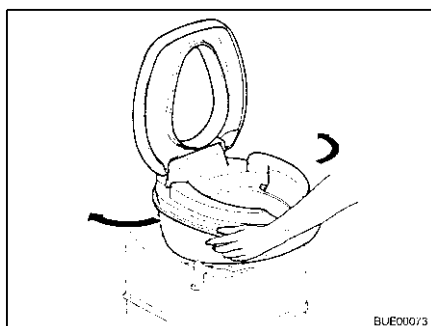

Fig. 246 Rotating the toilet bowl

- Using the toilet:*
- Move the toilet bowl into a convenient position.

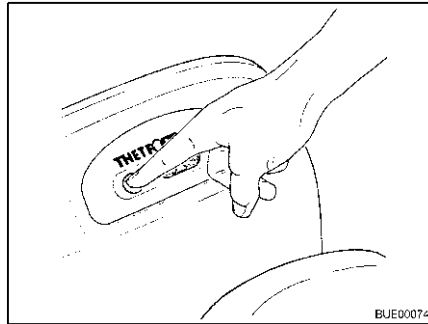

Fig. 247 Pre-flush

- Fill the toilet bowl with some water. Press the flush button. Flushing continues as long as the button is pressed.
- Use the toilet.

C-200 S cassette With the C-200 S cassette, proceed as follows to flush the toilet:

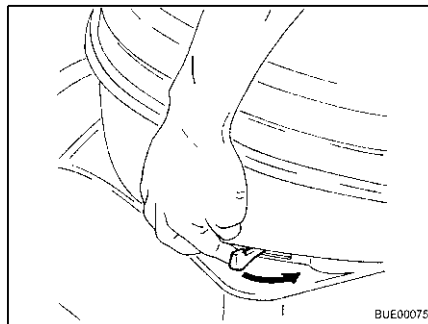

Fig. 248 Operating the sliding trap

- Open the sliding trap. To do this, turn the slide lever in an anticlockwise direction.

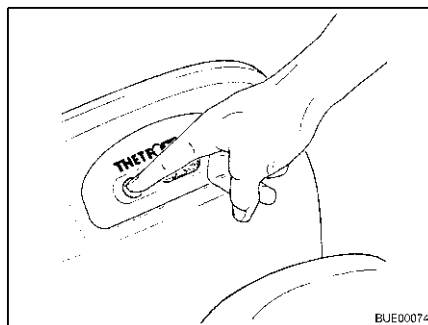

Fig. 249 Operating the flush

- Flush the toilet. Press the flush button.
- After flushing close the sliding trap.

C-200 E cassette With the C-200 E cassette, proceed as follows to flush the toilet:

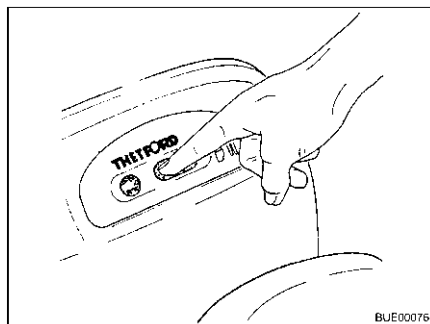

Fig. 250 Opening the sliding trap

- Open the sliding trap. To do this, press the left side of the sliding trap button.

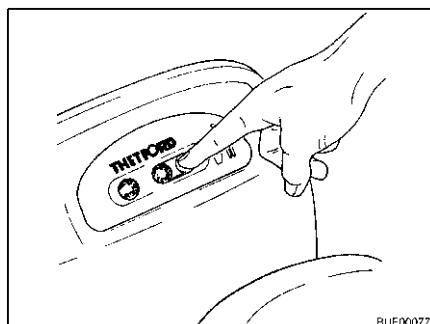

Fig. 251 Closing the sliding trap

- Flush the toilet. Press the flush button.
- After flushing close the sliding trap. To do this, press the right side of the sliding trap button.



- ▷ The Thetford cassette can only be taken out if the sliding trap is closed.

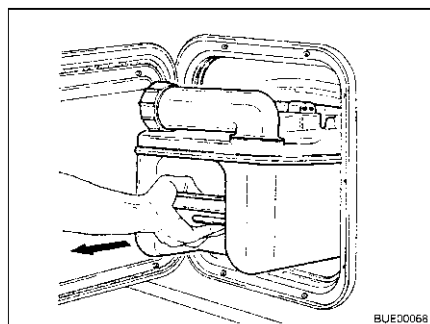

Fig. 252 Removing the Thetford cassette

Emptying the Thetford cassette:

- Open the flap for the Thetford cassette and pull the retaining clip upwards to remove the Thetford cassette.
- Pull out the Thetford cassette as far as it can go.
- Tip the Thetford cassette slightly and then pull it out completely.

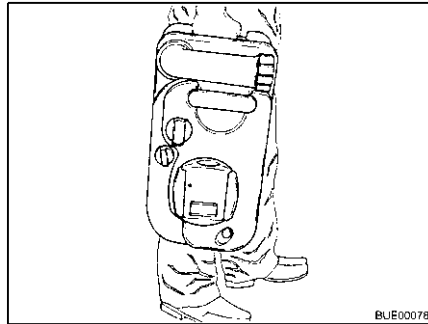

Fig. 253 Carrying the Thetford cassette

- Take the Thetford cassette to a proper disposal area. As you do this, point the drainage neck upwards.

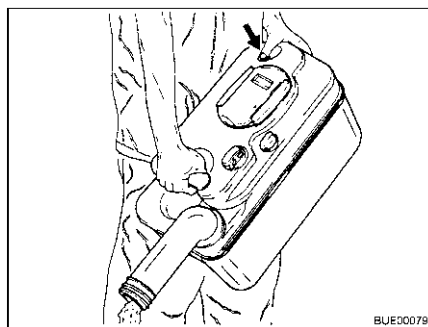

Fig. 254 Emptying the Thetford cassette

- Turn the drainage neck upwards.
- Remove the cap of the drainage neck.
- Point the Thetford cassette with the drainage neck downwards.
- Activate the aeration knob with your thumb. The Thetford cassette empties.
- Rinse the Thetford cassette thoroughly with fresh water.
- Close drainage neck with the cap.
- Return the drainage neck to its original position.

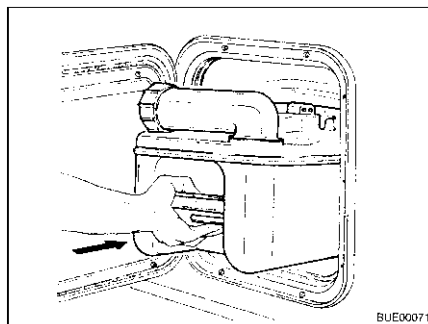

Fig. 255 Inserting the Thetford cassette

- Prepare the Thetford toilet for use.
- Push the Thetford cassette back to its original position.
- Ensure that the Thetford cassette is secured by the retaining clip.
- Lock the flap for the Thetford cassette.

10.7.2 Toilet with fixed seat (Thetford C-402)



- ▷ The Thetford cassette can only be taken out if the sliding trap is closed.

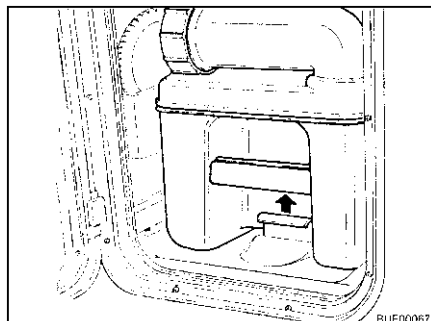

Fig. 256 Pulling the retaining clip

Preparing toilet:

- Open the flap for the Thetford cassette and pull the retaining clip upwards to remove the Thetford cassette.

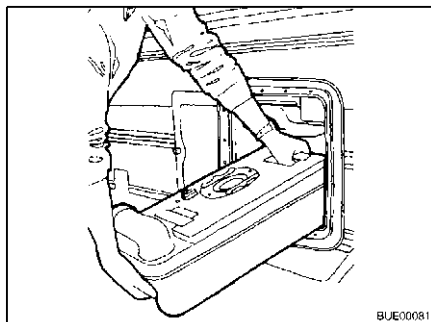

Fig. 257 Removing the Thetford cassette

- Pull out the Thetford cassette as far as it can go.
- Tip the Thetford cassette slightly and then pull it out completely.

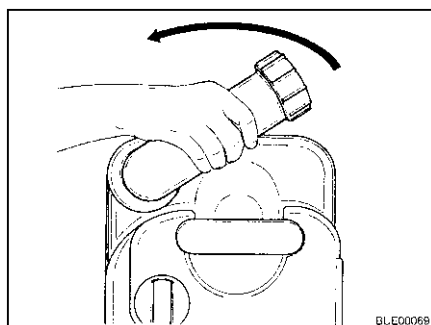

Fig. 258 Turning drainage neck

- Place the Thetford cassette upright.
 - Turn the drainage neck upwards.
 - Remove the cap of the drainage neck.
- ▷ Never put the sanitary liquid directly in the toilet bowl.



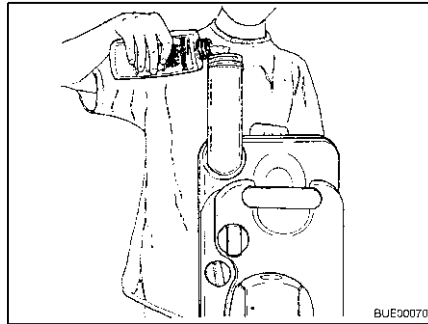

Fig. 259 Filling with sanitary liquid

- Fill the Thetford cassette with the specified quantity of sanitary liquid.
 - Then add enough water to completely cover the bottom of the Thetford cassette.
 - Close drainage neck with the cap.
 - Return the drainage neck to its original position.
- ▷ When inserting, do not use force. The Thetford cassette can be damaged.

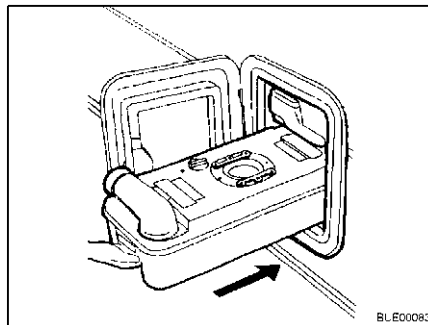

Fig. 260 Inserting the Thetford cassette

- Push the Thetford cassette back to its original position.

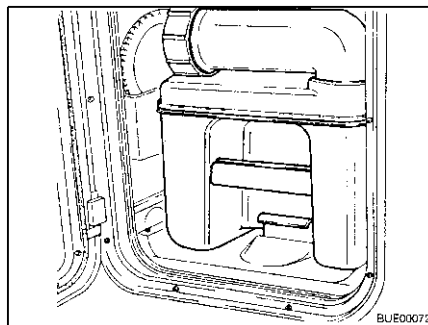

Fig. 261 Thetford cassette secured

- Ensure that the Thetford cassette is secured by the retaining clip.
- Lock the flap for the Thetford cassette.

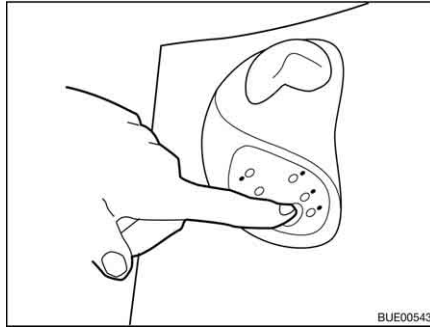

Fig. 262 Pre-flush

Using the toilet:

- Fill the toilet bowl with some water. Press the flush button. Flushing continues as long as the button is pressed.
- Use the toilet.

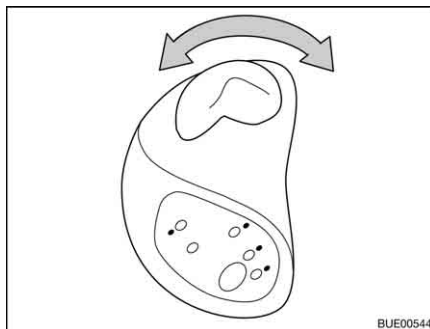

Fig. 263 Operating the sliding trap

- Open the sliding trap. To do this, turn the slide lever in an anticlockwise direction.

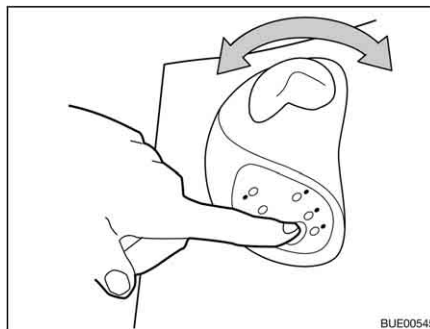

Fig. 264 Operating the flush

- Flush the toilet. Press the flush button.
- After flushing close the sliding trap again. To do this turn the slide lever in a clockwise direction.



- ▷ The Thetford cassette can only be taken out if the sliding trap is closed.

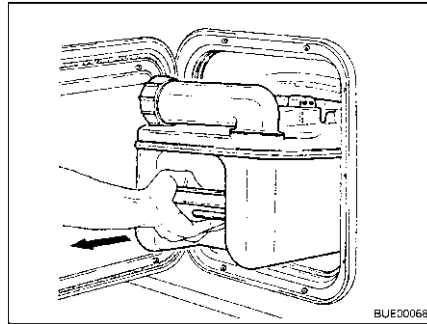

Fig. 265 Removing the Thetford cassette

Emptying the Thetford cassette:

- Open the flap for the Thetford cassette and pull the retaining clip upwards to remove the Thetford cassette.
- Pull out the Thetford cassette as far as it can go.
- Tip the Thetford cassette slightly and then pull it out completely.



Fig. 266 Transporting the Thetford cassette

- Place the Thetford cassette upright on the wheels.
- Press down the handle of the draw bar and move away from the Thetford cassette. The lock of the draw bar releases itself.
- Pull the draw bar out completely by the handle.
- Take the Thetford cassette to a proper disposal area.
- Insert the draw bar completely using the handle.

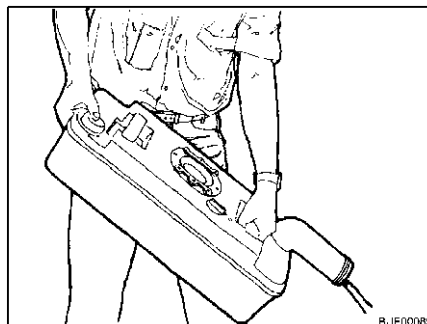

Fig. 267 Emptying the Thetford cassette

- Turn the drainage neck upwards.
- Remove the cap of the drainage neck.
- Point the Thetford cassette with the drainage neck downwards.

- Activate the aeration knob with your thumb. The Thetford cassette empties.
- Rinse the Thetford cassette thoroughly with fresh water.
- Close drainage neck with the cap.
- Return the drainage neck to its original position.

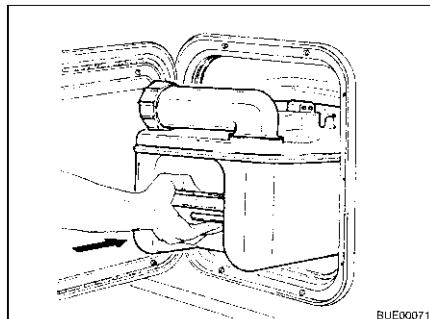

Fig. 268 Inserting the Thetford cassette

- Prepare the Thetford toilet for use.
- Push the Thetford cassette back to its original position.
- Ensure that the Thetford cassette is secured by the retaining clip.
- Lock the flap for the Thetford cassette.

10.7.3 Toilet (Dometic)



- ▷ The sewage tank (cassette) can only be taken out if the sliding trap is closed.

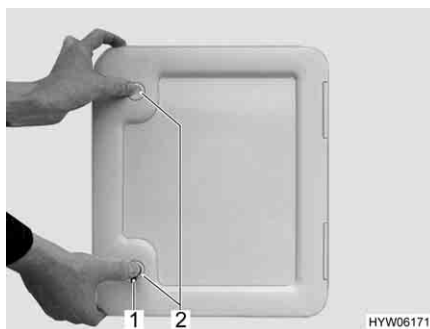

Fig. 269 Flap for sewage tank



Fig. 270 Sewage tank

Preparing toilet:

- Open the flap for the sewage tank on the outside of the vehicle. Insert the key into the locking cylinder of the push-button lock (Fig. 269,1) and turn a quarter turn.
- Remove the key.
- Press both push-button locks (Fig. 269,2) simultaneously with your thumb and open the flap.
- Pull up the retaining clip (Fig. 270,3) and use the handle (Fig. 270,2) to lift the sewage tank (Fig. 270,1) straight up.
- Tilt the sewage tank slightly and remove fully.

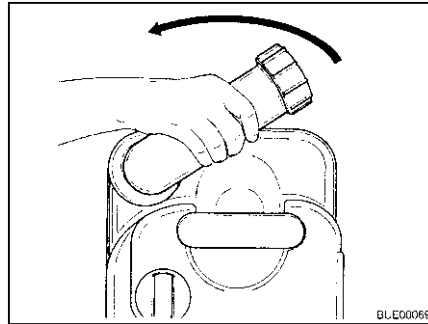

Fig. 271 Turning drainage neck

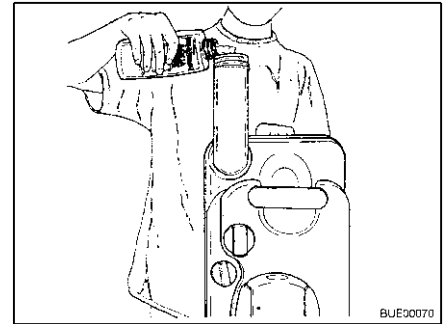

Fig. 272 Filling with sanitary liquid

- Put the sewage tank down vertically.
- Turn the drainage neck upwards.
- Remove the cap of the drainage neck.
- Fill the stated amount of sanitary liquid into the sewage tank.
- Then add enough water to completely cover the bottom of the sewage tank.
- Close drainage neck with the cap.
- Return the drainage neck to its original position.
- Push the sewage tank back to its original position without applying any force.
- Ensure that the sewage tank is secured by the retaining clip.
- Lock the flap for the sewage tank.



Fig. 273 Toilet bowl with control and operating unit

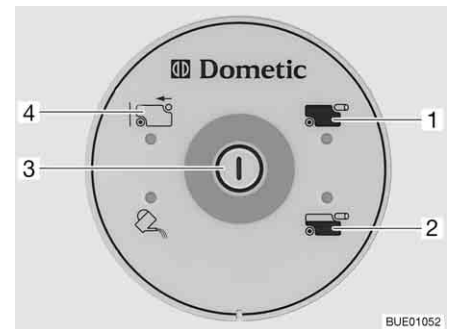

Fig. 274 Control and operating unit toilet

Let some water run into the toilet bowl before using the toilet. In order to do so press the flush button (Fig. 274,3) on the control and operating unit (Fig. 273,2).

Flushing:

- Before flushing open the sliding trap of the toilet. For this pull out the slide lever (Fig. 273,1).
- For flushing, press the flush button (Fig. 274,3).
- After flushing close the sliding trap. To do so, push the slide lever back.

The indicator lamp (Fig. 274,2) goes on whenever the sewage tank is filled up to 3/4.

The indicator lamp (Fig. 274,1) goes on whenever the sewage tank has to be emptied.

- Removal of sewage tank:*
- Push the slide lever (Fig. 273,1) in. The sliding trap is closed. To empty, the sliding trap of the toilet **must** be closed.
 - Open the flap for the sewage tank on the outside of the vehicle.
 - Pull up the retaining clip (Fig. 270,3) and use the handle (Fig. 270,2) to lift the sewage tank (Fig. 270,1) straight up.
 - Tilt the sewage tank slightly and remove fully. The display "Sewage tank removed" (Fig. 274,4) lights up on the control and operating unit.

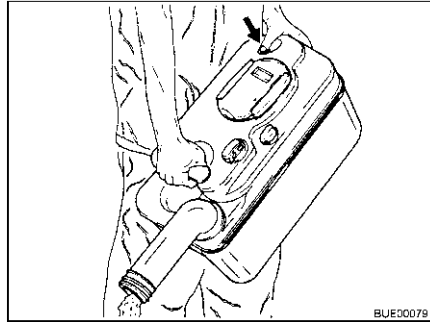

Fig. 275 Emptying the sewage tank

- Emptying the sewage tank:*
- Take the sewage tank to a disposal point especially provided for this purpose.
 - Turn the drainage neck as far upwards as possible.
 - Remove the cap of the drainage neck.
 - Point the sewage tank with the drainage neck downwards.
 - Activate the aeration knob with your thumb. The sewage tank empties.
 - Flush the sewage tank with water.
 - Close drainage neck with the cap.
 - Return the drainage neck to its original position.
 - Push the sewage tank back to its original position without applying any force.
 - Ensure that the sewage tank is secured by the retaining clip.
 - Lock the flap for the sewage tank.

Chapter overview

This chapter contains instructions regarding the care of the vehicle.

The instructions address the following topics:

- exterior of the vehicle
- interior
- water system
- extractor hood
- air conditioning unit
- winter operation

At the end of the chapter there is a checklist of measures you must carry out if you are not going to use the vehicle for an extended period of time.

The checklist address the following topics:

- temporary lay-up
- winter lay-up
- start-up after a lay-up

11.1 External care

11.1.1 General

Standard external care consists of regular washing. The use and the environmental conditions will determine how often the vehicle needs to be washed. Wash the vehicle more frequently in areas which are exposed to heavy air pollution or heavy traffic or roads treated with de-icing salts. If the vehicle is exposed to salty and humid air (coastal areas, humid climates), wash the vehicle more frequently.

Do not park under trees if at all possible. The resin-like discharge which many trees secrete, give the paintwork a matt look and can promote the onset of corrosion.

Wash off bird droppings straight away and thoroughly, as the acid it contains is extremely corrosive.

11.1.2 Washing with a high-pressure cleaner



- ▷ Do not clean the tyres with a high-pressure cleaner. The tyres might be damaged.
- ▷ Do not spray external applications (deco-films) directly with the high-pressure cleaner. The external applications could come off.

Before cleaning the vehicle with a high-pressure cleaner, observe the operating instructions of the high-pressure cleaner.

When cleaning with the nozzle for circular jet between the vehicle and the cleaning nozzle, maintain a minimum distance of approx. 700 mm.

Take into consideration that the jet of water comes out of the cleaning nozzle with pressure. The vehicle may be damaged by incorrect handling of the high-pressure cleaner. The temperature of the water should not be above 60 °C. Keep the jet of water in constant movement during the washing process. Do not direct the water jet at clearances, built-in electrical parts, plugs, seals, the ventilation grill or the skylights. The vehicle may be damaged or water may enter the interior.

11.1.3 Washing the vehicle



- ▷ Never clean the vehicle in the car wash. Water can enter the refrigerator grills, the waste gas vents, the ventilation of the extractor hoods or the forced ventilations. The vehicle could be damaged.
- Wash the vehicle only on a washing site intended for this purpose. Avoid full sunshine. Observe environmental measures.
- Only clean external applications and synthetic parts with plenty of warm water, dish washing liquid and soft cloth.
- Wash down the vehicle with plenty of water, a clean sponge or a soft brush. In the case of stubborn dirt add dish washing liquid to the water.
- Painted exterior walls may also be cleaned with a caravan cleaner.
- Add-on parts made of glass-fibre reinforced plastic (GRP) require a regular follow-up treatment with a polisher. This way these parts will not turn yellow and the sealing of the surface remains intact.
- Treat rubber seals of doors and storage flaps with talc.
- Treat locking cylinder of doors and storage flaps with graphite dust.

11.1.4 Windows of acrylic glass



Acrylic glass windows are delicate and require very careful handling.

- ▷ Never rub acrylic glass windows dry as dust particles might damage the surface!
- ▷ Only clean acrylic glass windows with plenty of warm water, some dish washing liquid and a soft cloth.
- ▷ Never use glass cleaning agents with chemical, abrasive or alcohol-containing additives. Premature brittleness of the panes and associated cracks may result from their use.
- ▷ Avoid contact of cleansing agents used for the body (e.g. tar- or silicone-removing agents) with acrylic glass.
- ▷ Do not clean vehicle in car wash.
- ▷ Do not attach stickers to the acrylic glass windows.
- ▷ Having cleaned the vehicle rinse acrylic glass with sufficient clear water.
- ▷ Apply talcum powder to rubber seals.



- ▷ An acrylic glass cleanser with antistatic effect is suitable for a follow-up treatment. Small scratches can be treated with an acrylic glass polish. These agents are available at the accessories shop.

11.1.5 Underbody

The underbody of the vehicle is partly coated with an age-resistant underbody protection. Should the underbody protection be damaged, repair immediately. Do not treat areas coated with underbody protection with spray oil.



- ▷ Only use products approved by the manufacturer. Our authorised dealers and service centres will be happy to advise you.

11.1.6 Waste water tank

Clean the waste water tank after every use.

Cleaning:

- Empty the waste water tank.
- Open the cleaning opening on the waste water tank and the drain cock.
- Thoroughly rinse out the waste water tank with fresh water.
- If possible, clean waste water sensors through the cleaning opening by hand.

11.1.7 Entrance step

If the entrance step is lubricated, coarse particles of dirt can settle on the lubricant during the journey and cause damage to the operating mechanism of the entrance step. Therefore, do not lubricate the moving parts of the entrance step.

11.2 Interior care



- ▷ If possible, treat stains immediately.
- ▷ Acrylic glass windows are delicate and require very careful handling (see section 11.1.4).
- ▷ Synthetic parts in the toilet and living area are very delicate and should be treated with care. Do not use solvents, alcohol-containing cleansers or scourers. This procedure will help you to avoid brittleness and formation of cracks.
- ▷ Hair colourants, nail varnish, cigarette ash and similar substances may cause permanent stains or discolouration. For this reason, you should prevent these substances from getting onto plastic parts. If they do get onto plastic parts, you should remove these substances immediately.
- ▷ Do not pour any corrosive agents into the drain holes. Never pour boiling water directly into the drain holes. Corrosive agents and boiling water cause damage to drainage pipes and siphon traps.
- ▷ Do not use vinegar based products to clean the toilet and water system, or for decalcification of the water system. Vinegar-based products may cause damage to seals or parts of the installation. Use standard decalcifying products for decalcification.
- ▷ Save water. Mop up all remaining water.
- ▷ Vacuum off carpets and cushions with a suitable brush attachment.



- ▷ For information about the use of maintenance products, our representatives and service centres will be glad to advise.
- Surface and knobs of furniture, lamps and synthetic parts in the toilet and living area should be cleaned with water and a wool cloth. A mild cleanser may be added to the water. If required, use furniture polish for the painted surfaces.
- Clean upholstery with dry foam specially manufactured for the use on upholstery or with the foam of a mild detergent. Do not wash upholstery. Always have it cleaned. Protect upholstery from direct sunlight so that it does not lose its colour.
- Clean upholstery made of novalife® with clear water only.

- Leather covers should be cleaned with a cotton cloth and a mild soap (curd soap). Make sure that the leather is not soaked through and that no water seeps through the seams of the leather covers.
- Curtains and net curtains should be dry cleaned.
- Vacuum clean the carpet, if necessary clean with carpet shampoo.
- Clean PVC-floor covering with a mild, soapy cleanser for PVC floors. Do not place carpet on wet PVC-floor covering. The carpet and the PVC-floor covering may stick together.
- Never clean the sink or the gas cooker with a scourer. Avoid anything which may cause scratching or grooves.
- Clean the burners on the gas cooker using a damp cloth only. Prevent any water from penetrating the burner covers. Water may damage the burners on the gas cooker.
- Brush insect screens on doors, windows and skylights with a soft brush or vacuum with the brush attachment of the vacuum cleaner.
- Brush blinds with a soft brush or vacuum with the brush attachment of the vacuum cleaner. Grease or stubborn dirt may be removed with a mild soap at 30 °C (curd soap).
- Brush Roman shades with a soft brush or vacuum with the brush attachment of the vacuum cleaner. Grease or stubborn dirt may be removed with a mild soap at 30 °C (curd soap).
- Unrolled seat belts can be cleaned with warm soapsuds. The seat belt must be completely dry before being rolled up.
- Wipe the fuel cell with a soft, damp cloth.

11.3 Water system

11.3.1 Cleaning the water tank

- Empty the water tank and close the drainage opening.
- Remove the cap of the water tank.
- Fill water tank with water and some washing-up liquid (do not use any scourers).
- Using a trade standard brush for washing dishes, scrub the water tank until there is no longer any visible deposit.
- Scrub also the pump housing.
- If possible, clean fresh water sensors through the cleaning openings by hand.
- Rinse water tank with copious amounts of drinking water.

11.3.2 Cleaning the water pipes



- ▷ Only use suitable cleaning agents as sold by the specialist trade.



- ▷ Collect any emerging mixture of water and cleaning agent for correct disposal.

- Empty the water system.
- Close all drain holes and drain cocks.
- Fill mixture of water and cleaning agent into the water tank. Observe the manufacturer's instructions regarding the mixing ratio.
- Open the drain cocks one by one.
- Leave the drain cocks open until the mixture of water and cleaning agent has reached the respective drain.
- Close the drain cocks.
- Set all the water taps to "Hot" and open them.
- Leave the water taps open until the mixture of water and cleaning agent has reached the drain.
- Set all water taps to "Cold" and open them.
- Leave the water taps open until the mixture of water and cleaning agent has reached the drain.
- Close all water taps.
- Flush the toilet several times.
- Allow the cleaning agent to act in accordance with the manufacturer's instructions.
- Empty the water system. Collect the mixture of water and cleaning agent for correct disposal.
- For rinsing fill the entire water system with drinking water and empty again several times over.

11.3.3 Disinfecting the water system



- ▷ Only use suitable disinfectants as sold by the specialist trade.



- ▷ Collect any emerging mixture of water and disinfectant for correct disposal.

- Empty the water system.
- Close all drain holes and drain cocks.
- Fill mixture of water and disinfectant into the water tank. Observe the manufacturer's instructions regarding the mixing ratio.
- Open the drain cocks one by one.
- Leave the drain cocks open until the mixture of water and disinfectant has reached the respective drain.
- Close the drain cocks.
- Set all the water taps to "Hot" and open them.
- Leave the water taps open until the mixture of water and disinfectant has reached the drain.
- Set all water taps to "Cold" and open them.
- Leave the water taps open until the mixture of water and disinfectant has reached the drain.
- Close all water taps.
- Flush the toilet several times.

- Allow the disinfectant to act in accordance with the manufacturer's instructions.
- Empty the water system. Collect the mixture of water and disinfectant for correct disposal.
- For rinsing fill the entire water system with drinking water and empty again several times over.

11.4 Extractor hood

Clean the extractor hood filter occasionally. How often cleaning is necessary depends on how often the extractor hood is used. Do not wait to clean the filter until the performance of the extractor hood has noticeably decreased.

Cleaning the filter: ■ Wash the filter with warm water and some washing-up liquid.

11.5 Air conditioning unit

11.5.1 Dometic



Fig. 276 Air conditioning unit (Dometic)

A lint filter and an activated carbon filter are each located in the lower part of the air conditioning system ceiling unit (Fig. 276,2) behind the ventilation grilles (Fig. 276,1 and 3). The lint filters must be cleaned at regular intervals and replaced if necessary. The manufacturer recommends replacing the activated carbon filter yearly.

On the left side of the ceiling unit (outside of the vehicle) is located the drainage opening for the condensation. Keep the drain openings free from dirt, leaves or similar to allow the condensation to be drained.

11.5.2 Telair

Every now and then clean the filter and the ventilation grilles on the outside of the housing. How often cleaning is necessary depends on how often the air conditioning unit is used. Do not wait to clean the filter and the ventilation grill until the performance of the air conditioning unit has noticeably decreased.



- ▷ Only use mild cleaning solutions to clean the filter, never use benzene or solvents.

Cleaning the filter: ■ Wash the filter with warm water and some washing-up liquid.
 ■ Allow the filter to dry thoroughly before reassembly.

Cleaning the ventilation grill:

- Use a brush to remove coarse dirt or deposits from the external ventilation grilles. If a cleaning solution is used, ensure that no water ingresses into the inside of the housing.

11.6 Winter care

De-icing salt damages the underbody and the parts open to water spray. We recommend that you wash the vehicle more frequently during wintertime. Mechanical and surface treated parts and the underside are under particular strain, and should therefore be cleaned thoroughly.



- ▷ If there is any risk of frost, always run heater at a minimum of 15 °C. Switch the circulation fan (if there is one) to automatic. In the case of extreme external temperatures, the furniture flaps and doors should be left slightly open. The inflowing warm air can help prevent the freezing of water pipes, for example, and counteract the formation of condensation in the storage spaces.
- ▷ If there is any risk of frost, cover the outside surface of the windows with winter insulation mats.
- ▷ Keep waste gas vents and forced ventilations free of snow. Use a vent extension, if necessary.

11.6.1 Preparations

- Check the vehicle for paint and rust damage. Repair damage as necessary.
- Make certain that water cannot penetrate the automatic floor ventilation system and the heater.
- Use a wax-based rust inhibitor to protect the metal parts of the underbody.
- Use appropriate protection for external painted surfaces.

11.6.2 Winter operation

During winter operation, condensation develops when the vehicle is occupied under low-temperature conditions. To ensure good interior air quality and avoid vehicle damage from condensation, sufficient ventilation is essential.

- When heating the vehicle, the heater should be at the highest setting and roof storage cabinets, curtains and blinds should be opened. This ensures optimal ventilation.
- Only heat if the circulation system is switched on.
- In the morning, lift up all cushions, air out storage boxes and dry any damp areas.



- ▷ If condensation has still developed, just wipe it off.
- ▷ It is only possible to guarantee unrestricted operation during winter for models without double floor in connection with the "winter package" from the original equipment.

11.6.3 At the end of the winter season

- Thoroughly clean the underbody of the vehicle and the engine. When this is done, corrosion-inducing anti-freeze agents (salts, alkaline residues) are removed.
- Clean the exterior and use regular car wax to protect metal surfaces.

11.7 Lay-up

11.7.1 Temporary lay-up



- ▶ If the vehicle has been stationary for a long period (approx. 10 months) have the braking and gas systems checked by an authorised specialist workshop.
- ▶ Take into consideration that water is undrinkable after only a short time.
- ▶ Animal damage to cables can lead to short circuits. Fire hazard!

Before laying up the vehicle, go through the following checklist:

	Activities	Done
Base vehicle	Completely fill fuel tank. This prevents corrosion damage within the fuel tank system	
	Jack up vehicle so that the wheels do not bear any load, or move vehicle every 4 weeks. This prevents any pressure points from occurring on tyres and wheel bearings	
	Protect the tyres from direct exposure to the sun. Danger of formation of cracks!	
	Inflate tyres up to the recommended maximum pressure	
	Always provide for sufficient ventilation in the underbody area	
	 ▶ Humidity or lack of oxygen e.g. by covering with plastic film may cause optical irregularities to the underbody. In addition observe the notes in the operating manual of the base vehicle	
Body	All vents should be sealed with the appropriate caps and all other openings (apart from forced ventilations) should also be sealed. This prevents animals (e.g. mice) from gaining entry	
	Air the interior, all storage compartments accessible from the outside, and the parking space (e.g. garage) every 3 weeks in order to prevent the occurrence of condensation and resulting mould formation	
Interior	Place upholstery in an upright position for ventilation, and cover	
	Clean refrigerator	
	Allow refrigerator and freezer compartment doors to remain slightly open	
	Search for traces of animals that have gained entry	
	Disconnect the flat screen from the mains and, if necessary, remove it from the vehicle	

	Activities	Done
Gas system	Close regulator tap on the gas bottle	
	Close all gas isolator taps	
	Always remove gas bottles from the gas bottle compartment, even if they are empty	
Electrical system	Fully charge living area and starter battery  ▷ Charge the battery for at least 20 hours before laying up.	
	Disconnect the living area battery from the 12 V power supply. To do this, switch off the battery cut-off switch on the transformer/rectifier (see chapter 8)	
Water system	Empty the entire water system. Blow out the residual water from the water pipes (0.5 bar max.). Leave the water taps on in central position. Leave the safety/drainage valve (if there is one) and all drain cocks open. Observe the notes in chapter 10	

11.7.2 Winter lay-up

Additional measures are required if laying up the vehicle over winter:

	Activities	Done
Base vehicle	Clean body and underbody thoroughly and spray with hot wax or protect with varnish	
	Fill fuel tank with winter diesel	
	Check antifreeze in the cooling water	
	Rectify damage to the paintwork	
Body	Clean vehicle from outside thoroughly	
	Keep the forced ventilation open	
	Clean and grease installed supports	
	Clean and grease all door and flap hinges	
	Brush oil or glycerine on all locking mechanisms	
	Rub all rubber seals with talc	
	Use graphite dust to treat locking cylinders	
Interior	Position de-humidifiers	
	Remove upholstery from the vehicle and store in a dry place	
	Air the interior every 3 weeks	
	Empty all cabinets and storage compartments, open flaps, doors and drawers	
	Thoroughly clean the interior	
	If there is a risk of frost, do not leave the flat screen in the vehicle	

	Activities	Done
Electrical system	Remove the starter battery and the living area battery and store them in a place protected from frost (see chapter 8) or connect the vehicle to a 230 V supply	
Water system	Clean the water system using a cleaning agent from a specialised store	
Complete vehicle	Arrange the tarpaulins in such a way that the ventilation openings are not covered, or use porous tarpaulins	

11.7.3 Starting up the vehicle after a temporary lay-up or after lay-up over winter

Go through the following checklist before start-up:

	Activities	Done
Base vehicle	Check the tyre pressure on all tyres Check the tyre pressure of the spare wheel	
Body	Clean the pivot bearing of the entrance step Check the functioning of the fitted supports Check that the doors, windows and skylights are working properly Check that all the external locks are working, such as the external flaps, the filler neck and the conversion door Remove the cover from the waste gas vent of the heater (if there is one) Remove the winter cover from the refrigerator grills (if there is one)	
Gas system	Put the gas bottles in the gas bottle compartment, tie down and connect to the gas pressure regulator	
Electrical system	Connect to 230 V power supply using the external socket Fully charge living area and starter battery  ▷ Charge the battery for at least 20 hours after lay-up. Connect the living area battery with the 12 V power supply. To do this, switch on the battery cut-off switch on the transformer/rectifier (see chapter 8) Check that the electrical system are working, e.g. interior light, socket and all installed electrical appliances	

	Activities	Done
Water system	Disinfect water pipes and water tank	
	Check the functionality of the operating lever for the waste water tank	
	Close safety/drainage valve (if there is one), drain cocks and water taps	
	Check water system for leaks	
Appliances	Check the function of the appliances	

Chapter overview

This chapter contains instructions about inspection and maintenance work concerning the vehicle.

The maintenance instructions address the following topics:

- doors
- living area battery
- fuel cell
- Alde hot-water heater
- independent vehicle heater
- replacing light bulbs

At the end of the chapter you will find important instructions on how to obtain spare parts.

12.1 Inspection work

Like any technical appliance, the vehicle must be inspected at regular intervals.

This inspection work must be carried out by qualified personnel.

Special technical knowledge, which cannot be taught within the framework of this instruction manual, is required for these tasks. Personnel possessing this technical knowledge are available for assistance at all our service centres. Their experience and regular technical instruction by the factory as well as equipment and tools guarantee expert and up-to-date inspection of the vehicle.

Have the "First Programmed Inspection" carried out at one of our service centres 12 months after initial registration.

Further inspections should be carried out once a year.

The service centre in charge will confirm the work performed.

Have chassis inspections confirmed in the chassis manufacturer's customer service booklet.



- ▷ Observe the inspections indicated by the manufacturer and have them carried out at the specified intervals. The value of the vehicle is thus preserved.
- ▷ The confirmation of the inspection work carried out serves as valid proof in the event of damage and guarantee claims.

12.2 Maintenance work

As with every machine, this vehicle requires maintenance. The extent and frequency of the maintenance work required depend on conditions of operation and use. More difficult operating conditions make it necessary to service the vehicle more often.

Have the base vehicle and the appliances serviced at the intervals specified in the corresponding instruction manuals.

12.3 Doors

To maintain gliding capability between springs and hinges, grease the conversion door hinges occasionally.



- ▷ We recommend either Molykote PG 65 or Vaseline as lubricants.

12.4 Living area battery



- ▷ When replacing the battery, only use the same type of battery (same capacity and voltage, cycle stability).
- ▷ Never use conventional car batteries (starter batteries). A lead acid battery must not be replaced by a dryfill battery.
- ▷ Do not use so-called improvers.

Observe the following to extend battery life:

- Keep the battery surface clean and dry.
- Check the acid level periodically and top up with desalinated or distilled water as necessary. Never top up with acids.
- If water loss is considerable, have the controller voltage checked by an authorised specialist workshop.
- Use an acid density measurement to check the battery's charging condition.

Acid density

- The battery must be recharged if the acid density falls below 1.21 kg/l. If battery acid with a density of 1.23 kg/l is used, the battery must be recharged when the acid density falls below 1.18 kg/l.
- With acid density of 1.21 kg/l, the battery is protected against freezing at temperatures up to -15 °C (at 1.28 kg/l up to -70 °C).

The battery has cycle stability and is thus particularly suited for vehicle power supply. Cycle stability means that several discharge/charging processes are possible.

12.5 Fuel cell

12.5.1 Replacing the tank cartridge



- ▶ When changing tank cartridges, do not smoke and avoid unshielded flames. Fire hazard!
- ▶ Methanol is toxic. Avoid inhaling, swallowing or any contact with the skin or the eyes.



- ▷ When connecting the tank, make sure that the tank hose has no kinks and that it is not squashed.
- ▷ Only use original SFC tank cartridges.



- ▷ The tank cartridge may only be replaced if the system is running.
- ▷ Any methanol emerging will evaporate without residue.
- ▷ Original tank cartridges are available from all authorised dealers and service centres.
- Unscrew the tank cartridge connection from the empty tank cartridge.
- Loosen the securing belt on the tank cartridge.
- Remove empty tank cartridge from the tank cartridge holder.

- After use, firmly close the cap of the tank cartridge.
- Insert a new, sealed original tank cartridge into the tank cartridge holder.
- Secure the tank cartridge with the securing belt.
- Open cap and keep safe.
- Screw tank cartridge connection onto the new tank cartridge.
- In the "Main Menu > Fuel Cartridge" menu, specify the tank cartridge size used and confirm with "OK".

12.5.2 Refilling service fluid



- ▷ Only use original SFC refill sets.
- ▷ Only replenish service fluid if a message to do so appears on the operating panel.
- ▷ Ensure that no dirt or foreign bodies enter the filling hole.



- ▷ Original refill sets are available from all authorised dealers and service centres.
- ▷ Wipe up any spilled service fluid with a cloth.
- Turn off fuel cell and remove the device's connector plug.
- Remove the air discharge hose.
- Cut off the tip of the nozzle on the refill bottle.
- Pour the entire content of the refill bottle into the connection for the air discharge hose.
- Re-insert the air discharge hose.
- Plug the device's connector plug back on again.
- Press the reset button.

12.6 Alde hot-water heater



- ▷ Check the level of the heating fluid regularly on the compensator reservoir.
- ▷ During or after the first operating hours of the hot-water heater, the filling level may fall below the minimum mark. If this is the case, top up the heating fluid.
- ▷ We recommend to bleed the heating system after the initial heater operation and to check the glycol content.
- ▷ Have heating fluid changed by an authorised dealer or a service centre at intervals of approximately two years as corrosion-protection wears off after some time.
- ▷ Top up heating system with a water-glycol mixture (60 : 40) only. This mixture offers frost protection up to approx. -25 °C. When topping up hot-water heaters that are connected to the engine's cooling circuit, please observe the instructions in the instruction manuals of the manufacturers.



- ▷ Further information can be obtained in the manufacturer's instruction manual.

12.6.1 Checking the fluid level



Fig. 277 Compensator reservoir hot-water heater

- Switch off the hot-water heater and allow it to cool down.
- Check if the fluid level is between the marks "MIN" (Fig. 277,3) and "MAX" (Fig. 277,2) on the compensator reservoir (Fig. 277).

12.6.2 Topping up heating fluid

- Position the vehicle horizontally. This prevents the formation of bubbles.
- Switch off the hot-water heater and allow it to cool down.
- Unscrew or pull off the panel.
- Open the rotary lid (Fig. 277,1) on the compensator reservoir.
- Remove cover.
- Check anti-freeze with an anti-freeze hydrometer. The frost protection content must be 40 % or correspond to a frost protection of -25 °C.
- Fill water frost protection mixture slowly into the compensator reservoir.



- ▷ The optimum fluid level is reached when the fluid in the compensator reservoir is 1 cm above the "MIN" mark when it is cooled down.

12.6.3 Bleeding the heating system



Fig. 278 Bleeding valve of hot-water heater

The bleeding valves are built in nearby the radiators.

- Switch off the hot-water heater and allow it to cool down.
- Open bleeding valve (Fig. 278,1) and leave open until no more air escapes.

- Close bleeding valve.
- Repeat this procedure at all bleeding valves.
- Check to see if the hot-water heater warms up.

12.7 Independent vehicle heater

Use the independent vehicle heater for 10 minutes at least once a month with a cold engine and smallest fan settings.

Before the heating season starts, have the independent vehicle heater checked by an authorised specialist workshop.

12.8 Replacing bulbs, external



- ▶ Bulbs and light fittings can be extremely hot. Therefore, allow lights to cool down before changing bulbs.
- ▶ Store bulbs in a safe place inaccessible to children.
- ▶ Do not use any bulb that has been dropped or which shows scratches in its glass. The bulb might burst.



- ▷ A new bulb should not be touched with the fingers. Use a cloth when installing the new bulb.
- ▷ Use only bulbs of the same type and with the correct wattage (see table "Types of bulbs for exterior lighting").
- ▷ If LEDs in lights are defect, contact an authorised dealer or service centre.

Types of bulbs

Different types of bulbs are used in the vehicle. Below, we have described how to change the different types of bulbs.

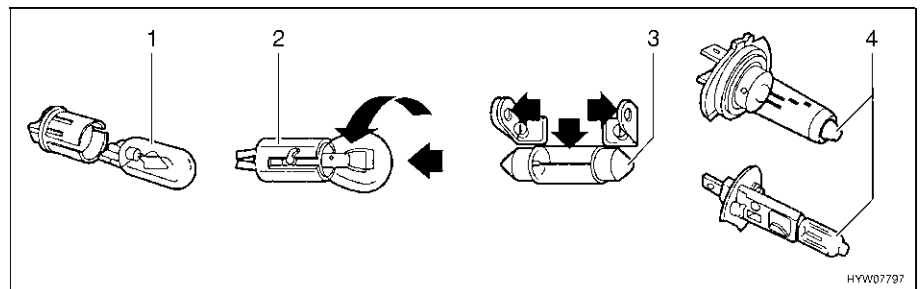

Fig. 279 Types of bulbs

Pos. in Fig. 279	Fixture type/bulb type	Changing
1	Plug-in fixture	To remove, pull out the bulb
		To mount, push the bulb into the socket with gentle pressure
2	Bayonet socket	To remove, press the bulb down and turn in an anticlockwise direction
		To insert, place the bulb in the socket and turn in a clockwise direction

Pos. in Fig. 279	Fixture type/bulb type	Changing
3	Cylindrical bulbs	To remove and to insert, carefully bend the contacts of the lamp holder outwards
4	Halogen bulb	To remove, release retaining springs After inserting, hook the retaining springs again

12.8.1 Front lights

The lamps for low beam, main beam and parking light as well as for the direction indicator are part of the basic vehicle. Replacement of light bulbs is described in the instruction manual of the base vehicle.

12.8.2 Rear lights

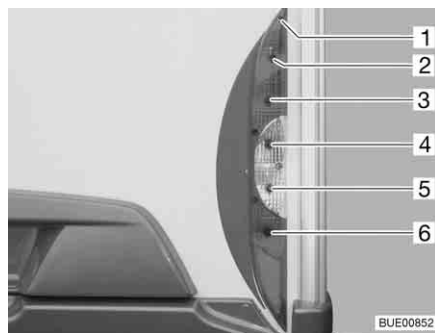

- 1 Housing screws
- 2 Rear light
- 3 Brake light
- 4 Direction indicator
- 5 Reverse light
- 6 Fog tail light

Fig. 280 Rear lights

- Undo the five housing screws (Fig. 280,1).
- Remove housing.
- Remove bulb.
- Put in a new bulb.
- Reassemble the lamp in the reverse order.

12.8.3 Side lights

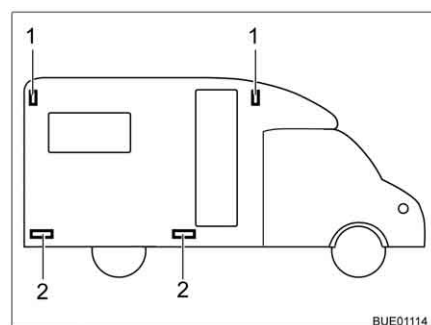

- 1 Side marker light
- 2 Marker light

Fig. 281 Side lights

Side marker light

Depending on the model, the side marker light (Fig. 281,1) is located in the upper side wall area of the vehicle at front or rear.

- Remove housing.
- Remove bulb.
- Put in a new bulb.
- Reassemble the lamp in the reverse order.

Marker lights

The marker lights (Fig. 281,2) are fitted in the lower part of the vehicle.



- ▷ The lights have LEDs. To change the LEDs, contact an authorised dealer or a service centre.

12.8.4 Types of bulbs for exterior lighting

	Exterior lighting	Type of bulb
Rear	Brake light	Ba15s 12 V 21 W
	Rear light	Ba15s 12 V 5 W
	Direction indicator	Ba15s 12 V 21 W orange
	Fog tail light	Ba15s 12 V 21 W
	Licence plate light	Soffitte 12 V 5 W
	Reverse light	Ba15s 12 V 21 W
	Third brake light	LED
Side	Marker light	LED
	Side marker light	Ba15s 12 V 5 W or Soffitte 12 V 5 W

12.9 Replacing bulbs, internal

- ▶ Bulbs and light fittings can be extremely hot. Therefore, allow lights to cool down before changing bulbs.
- ▶ Shut off the power supply on the safety cut-out in the 230 V fuse box before changing bulbs.
- ▶ Store bulbs in a safe place inaccessible to children.
- ▶ Do not use any bulb that has been dropped or which shows scratches in its glass. The bulb might burst.
- ▶ Lights can get very hot. When the light is switched on, there must always be a safety distance of 30 cm between light and flammable objects. Fire hazard!
- ▶ Do not replace the LEDs in lamps with standard light bulbs. Risk of fire due to intense heat build up.



- ▷ A new bulb should not be touched with the fingers. Use a cloth when installing the new bulb.
- ▷ Only use bulbs of the same type and with the correct wattage.
- ▷ If LEDs in lights are defect, contact an authorised dealer or service centre.

12.9.1 Recessed halogen light

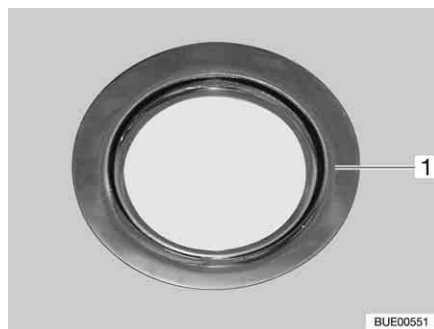

Fig. 282 Recessed halogen light (flat)

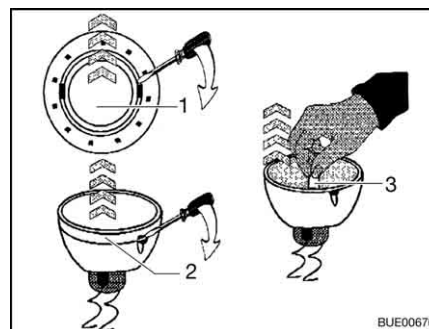

Fig. 283 Changing the halogen bulb

Halogen bulb 12 V/10 W

The recessed halogen light (Fig. 282,1) is installed flush.

Changing bulbs:

- Use a screwdriver to remove the inner cover ring (Fig. 283,1) from the housing.
- Use a screwdriver to remove the cover ring with the glass (Fig. 283,2) from the lower section of the recessed halogen light.
- Remove halogen bulb (Fig. 283,3).
- Put in a new halogen bulb.
- Reassemble the lamp in the reverse order.

12.9.2 Recessed halogen light (flat)



Fig. 284 Recessed halogen light (flat)

Halogen bulb G4 12 V/10 W

The recessed halogen light (Fig. 284,2) is installed flush with the panel.

Changing bulbs:

- Use a suitable tool (e.g. a screwdriver) to lever out the internal cover ring with glass disk (Fig. 284,1) from the housing.
- Remove halogen bulb.
- Put in a new halogen bulb.
- Reassemble the lamp in the reverse order.

12.9.3 Recessed light with LED



Fig. 285 Recessed light



- ▷ LED lamps have a very long life. It is not normally necessary to replace a lamp.

Changing bulbs: ■ Contact a dealer or service centre.

12.9.4 Halogen spotlight (movable)

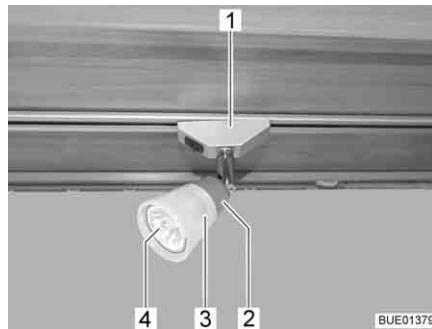

Fig. 286 Halogen spotlight (movable)



Fig. 287 Suction cup for replacing the lamp

Halogen bulb 12 V/10 W

- Changing bulbs:*
- Turn the halogen spotlight (Fig. 286,1) by 90° and remove from rail.
 - Turn the lamp shade (Fig. 286,3) in an anticlockwise direction.
 - Withdraw lamp shade complete with halogen bulb (Fig. 286,4) carefully from the holder (Fig. 286,2).
 - Remove halogen bulb.
 - Screw lamp shade onto holder.
 - Insert new halogen spot light into the lamp shade and press into holder.
 - Insert halogen lamp into the rail.



- ▷ A suction cup (Fig. 287,1) is included to help with changing the lamp.

12.9.5 Halogen spotlight (movable)

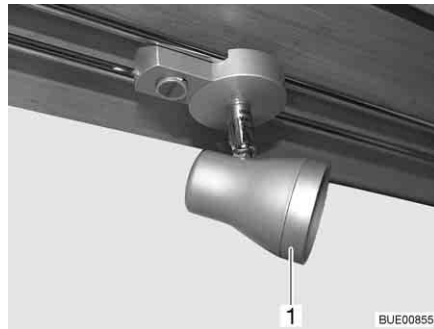

Fig. 288 Halogen spotlight (movable)

Halogen bulb 12 V/10 W

- Changing bulbs:*
- Turn outer ring (Fig. 288,1) in an anticlockwise direction until it separates from the housing.
 - Remove retaining ring.
 - Remove halogen bulb.
 - Put in a new halogen bulb.
 - Reassemble the lamp in the reverse order.

12.9.6 Wardrobe light

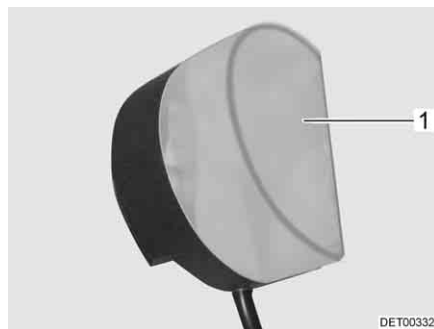

Fig. 289 Wardrobe light

Halogen bulb 12 V/8 W

- Changing bulbs:*
- Press the light covering (Fig. 289,1) lightly together and remove it.
 - Remove halogen bulb.
 - Put in a new halogen bulb.
 - Reassemble the lamp in the reverse order.

12.9.7 Garage light

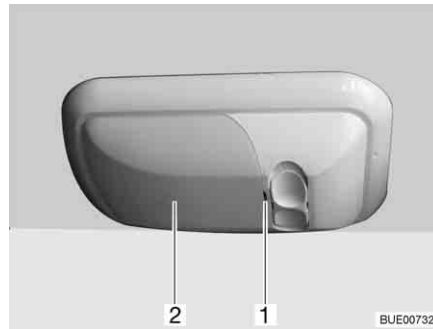

Fig. 290 Garage light

Halogen bulb 12 V/21 CP

Changing bulbs:

- Use a suitable tool (e.g. a screwdriver) to carefully lever out the cover (Fig. 290,2) at the notch (Fig. 290,1) and remove it.
- Remove halogen bulb.
- Put in a new halogen bulb.
- Reassemble the lamp in the reverse order.

12.10 Spare parts



- ▶ Every alteration of the original condition of the vehicle can alter road behaviour and jeopardize road safety.
- ▶ The special equipment and original spare parts recommended by us have been specially developed and supplied for your vehicle. These products are available at the authorised dealer or service centre. The authorised dealer or service centre is informed about admissible technical details and carries out the required work correctly.
- ▶ The use of accessories, parts and fittings not supplied by us may cause damage to the vehicle and jeopardize road safety. Even if an expert's report, a general type approval or a design certification exists, there is no guarantee for the proper quality of the product.
- ▶ No liability can be assumed for damage caused by products which have not been released by us. This also applies to impermissible alterations to the vehicle.

For safety reasons, spare parts for pieces of equipment must correspond with manufacturer's instructions and be permitted by the manufacturer as a spare part. These spare parts may only be fitted by the manufacturer or an authorised specialist workshop. The authorised dealers and service centres are available for any spare parts requirement.

Here are some suggestions of important spare parts:

- Fuses
- V-belt
- Windscreen blades
- Bulbs
- Water pump (submerged pump)

When ordering spare parts please indicate the chassis number and the vehicle type to the dealer.

The vehicle described in this instruction manual is built and equipped to factory standards. Special equipment is offered depending on its purpose or use. When fitting special equipment check if such equipment has to be entered in the vehicle documents. Observe the max. permissible gross weight. The authorised dealer or service centre will be happy to advise you.

12.11 Vehicle identification plate

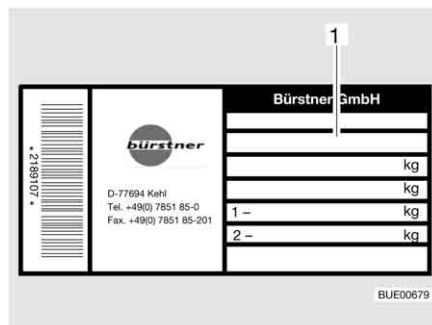

1 Chassis number

Fig. 291 Vehicle identification plate

The vehicle identification plate (Fig. 291) with the chassis number is mounted on the right hand side on the front.

Do not remove the vehicle identification plate. The vehicle identification plate:

- Identifies the vehicle
- Helps with the procurement of spare parts
- Together with the vehicle documents identifies the vehicle owner



- ▷ Always include the **chassis number** with all inquiries for the customer service office.

12.12 Warning and information stickers

There are warning and information stickers on and inside the vehicle. Warning and information stickers are for the sake of safety and must not be removed.



- ▷ Replacement stickers can be obtained from an authorised dealer or a service centre.

Chapter overview

This chapter contains instructions regarding the tyres of the vehicle.

The instructions address the following topics:

- tyre selection
- handling of tyres
- changing wheels
- spare wheel support

At the end of the chapter there is a table you can use to find the correct tyre pressure for your vehicle.

13.1 General



- ▶ Check tyre pressure before a journey or every 2 weeks. Wrong tyre pressure causes excessive wear and can lead to damage or even to tyre burst. You can lose control of the vehicle.



- ▷ Only check the tyre pressure on cold tyres.
- ▷ Tubeless tyres have been installed on the vehicle. Never install tubes in these tyres.
- ▷ Read the instruction manual for the base vehicle.



- ▷ Depending on the base vehicle and model the vehicles are only equipped with tyre repair kit as standard.
- ▷ In the case of a puncture, pull over to the side of the road. Make vehicle safe with a hazard warning triangle. Switch on the warning lights.
- ▷ Tyres on vehicles with tandem axles may wear faster.
- ▷ Tyres must not be older than 6 years as the material will become brittle over time. The four-digit DOT number on the tyre flank indicates the date of manufacture. The first two digits designate the week, the last two digits the year of manufacture.

Example:  Week 05, year of manufacture 2011.

- Observe:**
- Check the tyres regularly (every 2 weeks) for equal tread wear, tread depth and external damage.
 - Replace tyres at the latest, when the minimum depth of tread stipulated by law is reached.
 - Always use tyres of the same model, same brand and same style (summer and winter tyres).
 - Only use tyres approved for the wheel rim type fitted. The permitted rim and tyre sizes are quoted in the vehicle documents and the authorised dealer or service centre will always be glad to give you advice.
 - Run-in new tyres for approx. 100 km (60 miles) at low speed since only then do they reach full strength.

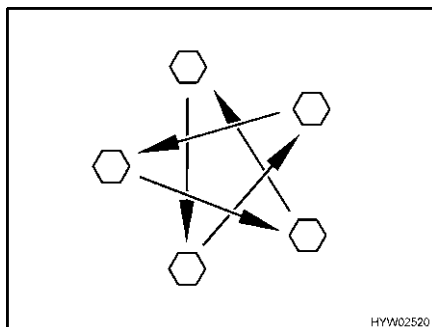

Fig. 292 Tighten the wheel nuts or wheel bolts cross-wise

- Check regularly that the wheel nuts or wheel bolts are firmly seated. Re-tighten the wheel nuts or wheel bolts of a changed wheel cross-wise (Fig. 292) after 50 km (30 miles). See section 13.5.2 for tightening torque.
- When using new or newly painted rims, re-tighten the wheel nuts or wheel bolts once again after approx. 1,000 to 5,000 km (600 miles to 3,000 miles).
- For lay-ups or long periods of inactivity, keep the tyres and tyre bearings free from pressure points:
Jack up the vehicle so that the wheels do not bear any load, or move the vehicle every 4 weeks in such a way that the position of the wheels is changed.

13.2 Tyre selection



- ▶ A wrong tyre can damage the tyres during the journey and even cause it to burst.



- ▷ If tyres that are not approved for the vehicle are used, then the type approval for the vehicle and subsequently the insurance coverage can lapse. The authorised dealer or service centre will be happy to advise you.

The tyre sizes approved for the vehicle are given in the vehicle documents or can be obtained from the authorised dealers or service centres. Each tyre must fit the vehicle on which it will be driven. This applies to the external dimensions (diameter, width), which are indicated with the standardised size designations. In addition, the tyres must meet the requirements of the vehicle with regard to weight and speed.

Weight refers to the maximum permissible axle load which can be distributed on two tyres. The maximum load-carrying capacity of a tyre is indicated by its load index (= LI, load index code).

The axle geometry of a vehicle, such as wheel camber and track, is also important for tyre selection. The maximum permissible speed for a tyre (with full load-carrying capacity) is indicated by the speed index (= SI). Together, load index and speed index form the operating code of a tyre. This is an official component of the complete, standardised dimensions description which appears on every tyre. The information on the tyres must correspond to the specifications which appear in the vehicle papers.

13.3 Tyre specifications

215/70 R 15C 109/107 Q
(example)

Description	Explanation
215	Tyre width in mm
70	Height-to-width proportion in percent
R	Tyre design (R = radial)
15	Rim diameter in inches
C	Commercial (transporter)
109	Load index code for single tyres
107	Load index code for twin tyres
Q	Speed index (Q = 160 km/h)

13.4 Handling of tyres

- Drive over kerbs at an obtuse angle. Otherwise the flanks of the tyres may get pinched. Driving over a kerb at a sharp angle can damage the tyre and result in it getting ruptured.
- Drive over high manhole covers at a slow speed. Otherwise the tyres may get pinched. Driving over a high manhole cover at high speed can damage the tyre and result in it getting ruptured.
- Check the shock absorbers regularly. Driving with poor shock absorbers significantly increases wear.
- If the tread wear is uneven, have the toe-in and the wheel camber checked. Driving with an incorrectly set toe-in or a one-sided wheel camber leads to a significant increase in wear.
- Avoid block brakings. Block braking gives the tyres "brake plates" of varying strength. This reduces driving comfort. It might even make the tyres unserviceable.
- Do not clean the tyres with a high-pressure cleaner. The tyres can suffer serious damage within just a few seconds and rupture as a result.
- Drive in such a way as to protect your tyres. Avoid braking sharply, revving up too strongly and long journeys on poor roads.

13.5 Changing wheels

13.5.1 General instructions



- ▶ The vehicle must be on level, firm ground, secure from slipping.
- ▶ Go into first gear. In the case of automatic transmission, change gear to "P" position.
- ▶ Before jacking up the vehicle firmly apply the handbrake.
- ▶ Prevent the vehicle from rolling away by blocking the opposite wheel with the wheel chocks.
- ▶ Under no circumstances jack the vehicle with the fitted supports.
- ▶ If a trailer is connected: Detach the trailer before lifting the vehicle.
- ▶ Position the vehicle jack underneath the axle, not under any circumstances on the bodywork.



- ▶ Never overload the vehicle jack. The maximum permissible load is specified on the vehicle jack's identification plate.
- ▶ Use the vehicle jack only for lifting the vehicle briefly while changing the tyre.
- ▶ No persons may be in the vehicle while it is raised.
- ▶ Do not start the motor while the vehicle is jacked up.
- ▶ Whilst the vehicle is in a jacked up position, persons must not lie down under it.



- ▷ Do not damage the thread of the thread bolt or wheel nut when changing the wheel.
- ▷ Tighten the wheel nuts or wheel bolts cross-wise (Fig. 292).
- ▷ When changing wheels (e.g. alloy wheel rims or wheels with winter tyres), use the correct wheel bolts of the correct length and shape. Otherwise the wheels may not be securely fixed or the braking system may not work correctly.
- ▷ The use of wheel rims or tyres that are not approved for the vehicle can make it less than fully roadworthy; such wheel rims or tyres must be separately inspected and approved by an accredited test centre.
- ▷ Do not replace wheels cross-wise.



- ▷ Protect the vehicle according to the national regulations, e.g. with a hazard warning triangle.
- ▷ Before changing the wheel, check the wheel rim and tyre size, the max. tyre load and the speed index on the tyres. Only use the wheel rim and tyre sizes stated in the vehicle documents.
- ▷ Further information can be found in the instruction manual of the base vehicle.

13.5.2 Tightening torque

Depending on the wheel rim type and the wheel manufacturer, the wheels must be tightened with different tightening torques.

Steel wheel rim

- Steel wheel rim 15": Tightening torque 160 Nm
- Steel wheel rim 16": Tightening torque 180 Nm

Alloy wheel rim Borbet



Fig. 293 Alloy wheel rim Borbet

- Alloy wheel rim 15" Borbet HW65560: Tightening torque 130 Nm
- Alloy wheel rim 16" Borbet HW65660: Tightening torque 130 Nm

Alloy wheel rim Tomason

Fig. 294 Alloy wheel rim Tomason

- Alloy wheel rim 15" Tomason TN3F-6515: Tightening torque 180 Nm
- Alloy wheel rim 16" Tomason TN3F-6516: Tightening torque 180 Nm

**Alloy wheel rim
Goldschmitt**

Fig. 295 Alloy wheel rim Goldschmitt

- Alloy wheel rim 15" Goldschmitt GSM1-1560: Tightening torque 180 Nm
- Alloy wheel rim 16" Goldschmitt GSM1-1665: Tightening torque 180 Nm

13.5.3 Changing a wheel



- ▶ The footplate of the vehicle jack must be levelly positioned on the ground.
- ▶ Do not tilt the vehicle jack.



- ▷ The wheel you have replaced should be repaired immediately.
- ▷ Take note of the general instructions in this chapter.



Fig. 296 Securing vehicle

- Park the vehicle on as even and stable a surface as possible.
- Switch off the engine and safeguard the area.
- Go into first gear. In the case of automatic transmission, change gear to "P" position.
- Apply the handbrake.
- Place wheel chocks or other appropriate objects beneath the opposite wheel of the vehicle to secure it (Fig. 296).
- Remove the spare wheel from the spare wheel support.
- If the ground is soft, place a stable support such as a wooden board beneath the vehicle jack.
- Apply the vehicle jack to the designated mounting points (refer to the instruction manual for the base vehicle).
- Turn the wheel bolts several times to loosen them, but do not remove them.
- Lift the vehicle until the wheel has been lifted 2 to 3 cm above the ground.
- Remove the wheel bolts and take off the wheel.
- Place the spare wheel on the wheel hub and adjust.
- Screw in the wheel bolts and slightly tighten them cross-wise.
- Crank down the vehicle jack and remove it.
- Using the wheelbrace, tighten the wheel bolts evenly (see section 13.5.2 for tightening torque).
- Have the tightening torque checked by an authorised specialist workshop.

13.6 Spare wheel support (special equipment)

The spare wheel support is built into the rear garage.

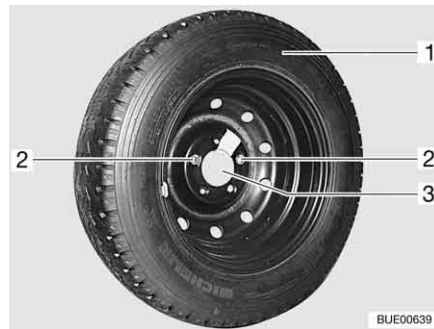

Fig. 297 Spare wheel support in the rear garage

Removing the spare wheel:

- Open external flap of the rear garage.
- Loosen and remove both fixing screws (Fig. 297,2) with the on-board tool set.
- Remove the spare wheel (Fig. 297,1) from the support (Fig. 297,3).

13.7 Tyre pressure



- ▶ Tyres overheat if the tyre pressure is too low. This can cause serious tyre damage.
- ▶ Check tyre pressure before a journey or every 2 weeks. Wrong tyre pressure causes excessive wear and can lead to damage or even to tyre burst. You can lose control of the vehicle.
- ▶ Use only valves that are approved for the specified tyre pressure.



- ▷ Only check the tyre pressure on cold tyres.

The payload and the durability of tyres is directly dependent on the tyre pressure. Air is a volatile medium. It is unavoidable that it will escape from tyres.

As a rule of thumb it can be assumed that a filled tyre loses pressure at a rate of 0.1 bar every two months. To prevent the tyres becoming damaged or burst, check the tyre pressure regularly.

The contact surface of the tyre changes, depending on the tyre pressure.

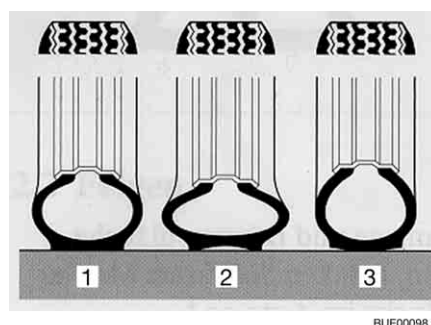

- 1 Correct tyre pressure
- 2 Tyre pressure too low
- 3 Tyre pressure too high

Fig. 298 Contact surface of the tyre



- ▷ The information on pressure levels is valid for cold tyres and loaded vehicles.
- ▷ Pressure in hot tyres must be 0.3 bar higher than in cold tyres. Recheck the pressure when the tyres are cold.
- ▷ Tyre pressures in bar.
- ▷ Over 4.75 bar requires a metal valve.
- ▷ The tyre pressure tolerance is +/- 0.05 bar.

Types	Tyre size	Front air pressure in bar	Rear air pressure in bar
All types	215/70 R 15 C (109/107) Q	4.1	4.5
All types with motorhome tyres	215/70 R 15 CP (109/107) Q	5.0	5.5
All types	225/75 R 16 C (116/114) R	4.5	5.0
All types with motorhome tyres	225/75 R 16 CP (116/114) R	5.5	5.5
All types	225/75 R 16 C (116/114) Q (tandem axle)	4.5	3.5
All types with motorhome tyres	225/75 R 16 CP (116/114) Q (tandem axle)	5.5	3.5

The vehicles are constantly brought up to the newest technical standards. It is possible that new tyre sizes are not yet included in this table. If this is the case, any authorised dealer or service centre will be happy to provide the newest values.

Chapter overview

This chapter contains instructions about possible faults in your vehicle. The faults are listed with their possible causes and corresponding remedies. The instructions address the following topics:

- braking system
- electrical system
- fuel cell
- gas system
- heater
- boiler
- air conditioning unit
- gas cooker
- gas oven
- microwave oven
- refrigerator
- water supply
- body

The specified faults can be remedied with relative ease and without a great deal of specialised knowledge. In the event that the remedies detailed in this instruction manual should not be successful, an authorised specialist workshop must find and eliminate the cause of the fault.

14.1 Braking system



- ▶ Have defects on the braking system immediately remedied by an authorised specialist workshop.

14.2 Electrical system



- ▷ When the living area battery is changed, only use batteries of the same type.



- ▷ See chapter 8 for changing the fuses.

Fault	Cause	Remedy
Road light system does no longer work correctly	Bulb is defective	Replace bulb. Note volts and watts specifications
Interior lighting does no longer work correctly	Bulb is defective	Replace bulb. Note volts and watts specifications
	Fuse on the transformer/rectifier is defective	Replace fuse on the transformer/rectifier
The electrically operated entrance step cannot be moved in or out	Fuse on the transformer/rectifier is defective	Replace fuse on the transformer/rectifier
No 230 V power supply despite connection	230 V automatic circuit breaker has triggered	Switch on the 230 V automatic circuit breaker

Fault	Cause	Remedy
Starter or living area battery is not charged when operated in 230 V mode	Jumbo flat fuse (50 A) on the starter or living area battery is defective	Replace jumbo flat fuse (50 A) on the starter or living area battery
	Charger module in the transformer/rectifier is defective	Contact customer service
Living area battery is not charged during vehicle operation	Fuse on terminal D+ of the alternator is defective	Replace fuse
	Disconnecter relay in the transformer/rectifier is defective	Contact customer service
12 V power supply does not work	12 V power supply switched off	Switch 12 V power supply on
	Battery cut-off switch on the transformer/rectifier is switched off	Set battery cut-off switch to on
	Living area battery is discharged	Charging the living area battery
	Jumbo flat fuse (50 A) on the living area battery is defective	Replace jumbo flat fuse (50 A) on the living area battery
	Disconnecter relay in the transformer/rectifier is defective	Contact customer service
12 V power supply does not work in 230 V operation	12 V power supply switched off	Switch 12 V power supply on
	Battery cut-off switch on the transformer/rectifier is switched off	Set battery cut-off switch to on
	Charger module in the transformer/rectifier is defective	Contact customer service
	230 V automatic circuit breaker has triggered	Contact customer service
	Jumbo flat fuse (50 A) on the living area battery is defective	Replace jumbo flat fuse (50 A) on the living area battery
	Disconnecter relay in the transformer/rectifier is defective	Contact customer service
Starter battery is discharged in 12 V operation	Disconnecter relay in the transformer/rectifier is defective	Contact customer service
	Battery cut-off switch on the transformer/rectifier is switched off	Set battery cut-off switch to on

Fault	Cause	Remedy
No voltage is supplied by the living area battery	Living area battery is discharged	Charge living area battery immediately  ▷ Total discharge damages the battery. If the vehicle is to be laid up for a long period, fully charge the living area battery beforehand Discharging is caused by inactive appliances (see chapter 8)
12 V indicator lamp does not light up	12 V power supply switched off	Switch 12 V power supply on
	Battery cut-off switch on the transformer/rectifier is switched off	Set battery cut-off switch to on
	Starter or living area battery is not charged	Charge the starter or living area battery
	Disconnecter relay in the transformer/rectifier is defective	Contact customer service
	Flat fuse (2 A) in the living area battery is defective	Replace flat fuse (2 A) in the living area battery
Extractor hood does not work	230 V automatic circuit breaker is switched off	Switch on the 230 V automatic circuit breaker
	Fuse (15 A) at the transformer/rectifier is defective	Replace fuse (15 A)
	Extractor hood defective	Contact customer service

14.3 Fuel cell



- ▷ Do not open the fuel cell. The fuel cell contains no parts that could be repaired by itself.
- ▷ All faults are not displayed. If the faults cannot be rectified using the following table or the instruction manual for the fuel cell, please contact the customer service.

Fault (display)	Cause	Remedy
Fuel cell cannot be switched on	No battery connected, battery connected incorrectly or totally discharged	Inspect the connection
	Fuse is defective	Replace fuse; if it happens again, contact the customer service
Failure: Environment too warm	Ambient temperature too high (40 °C)	Fuel cell restarts when the ambient temperature is between 0 °C and 40 °C

14.4 Gas system



- ▶ In case of a defect of the gas system (gas odour, high gas consumption) there is danger of explosion! Close regulator tap on the gas bottle immediately. Open doors and windows and ventilate well.
- ▶ If the gas system is defective: Do not smoke; do not ignite any open flames, and do not operate electric switches (light switches etc.).
- ▶ Have the defective gas system repaired by an authorised specialist workshop.

Fault	Cause	Remedy
No gas	Gas bottle is empty	Change gas bottle
	Gas isolator tap closed	Open the gas isolator tap
	Regulator tap on the gas bottle is closed	Open regulator tap on the gas bottle
	External temperature is too low (-42 °C for propane gas, 0 °C for butane gas)	Wait for higher external temperatures
	Built-in appliance is defective	Contact customer service

14.5 Heater/boiler

In the event of a defect contact the nearest customer service workshop of the relevant appliance manufacturer. The list of addresses is enclosed with the accompanying appliance documentation. Only authorised qualified personnel may repair the appliance.

14.5.1 Truma heater/boiler (gas heater)

Fault	Cause	Remedy
Heater does not ignite	Temperature sensor on operating unit or remote sensor defective	Pull out plug on operating unit. The heater then works without thermostat. Contact the customer service as soon as possible
Red indicator lamp "Fault" illuminates	Air in the gas pipe system	Switch off and on again. After two futile ignition attempts, wait for 10 minutes before trying again
	Lack of gas	Open regulator tap and gas isolator tap
		Connect a full gas bottle
Red indicator lamp "Fault" is flashing	Defect of a safety element	Contact customer service
	Operating voltage too low	Charge or replace the living area battery (or have it charged or replaced)

Fault	Cause	Remedy
Green indicator lamp behind knob is not lit	Fuse on the transformer/rectifier is defective	Replace fuse on the transformer/rectifier
	Fuse in the electronic control unit has been triggered	Contact customer service
	Living area battery defective	Charge or replace the living area battery (or have it charged or replaced)
Yellow indicator lamp on the energy selector switch does not illuminate	No supply voltage	Check 230 V connection and fuses
	Overheating switch was triggered	Press overheating switch
Boiler empties, safety/drainage valve has opened	Internal temperature below 8 °C	Heat inside
Safety/drainage valve cannot be closed	Temperature at safety/drainage valve below 8 °C	Heat inside
Red and green indicator lamps are not lit	Fuse is defective	Replace fuse on the transformer/rectifier
Fan wheel runs noisily or not steadily	Fan wheel is soiled	Contact Truma service department

14.5.2 Truma heater/boiler (diesel heater)

Fault	Cause	Remedy
No indicator lamp comes on after switching on	Fuse on the transformer/rectifier is defective	Replace fuse on the transformer/rectifier
	Fuse in the electronic control unit of the boiler is defective	Replace the fuse on the appliance. Call customer service if the fuse blows again
	No operating voltage	
Check all plug connectors		
Heater does not ignite (green indicator lamp comes on)	Room temperature is higher than the preset temperature range	Set a higher temperature range
	Temperature sensor defective	Contact customer service
Red indicator lamp "Fault" is flashing	Operating voltage too low	Charge or replace the living area battery (or have it charged or replaced)
	Warm air louvres blocked	Open air outlet louvres
	Air circulation suction system blocked	Remove blocking of air circulation suction system

Fault	Cause	Remedy
Red indicator lamp "Fault" illuminates	Summer operation with boiler empty	Fill the boiler with water
	Combustion air inlet or exhaust gas outlet blocked	Remove blockage (e.g. snow or dust)
	Low fuel	Fill tank with fuel
	Wrong fuel	Replace fuel
Green and red indicator lamps flash after switching off	Appliance was switched off by a fault	Wait for the appliance to run down. Then switch on the appliance and switch off again
Green indicator lamp flashes after switching off	Run-down for cooling of the appliance active	Wait for appliance to run down (approx. 5 minutes)
Safety/drainage valve opens after switching off	Internal temperature below 3 °C	Heat inside
Safety/drainage valve cannot be closed	Temperature at safety/drainage valve below 7 °C	Heat inside
	Rotary switch in "Off" position	Turn rotary switch to an operating mode
Water flows intermittently from the drain neck	Water pressure too high (over 2.8 bar)	If connected to a central water supply, install a pressure reducer
		Contact customer service

14.5.3 Aide heater/boiler



- ▷ If a fault occurs in the system, the cause is shown on the display.

Fault	Cause	Remedy
Heater does not ignite with gas operation	Lack of gas	Open regulator tap and gas isolator tap
		Connect a full gas bottle
Heater does not ignite	Battery voltage too low	Charge battery. If the battery voltage rises above 11 V, the heater is switched on automatically
Heater does not ignite at 230 V electrical operation	No 230 V power supply	Switch on the 230 V automatic circuit breaker
		Connect 230 V power supply
Heater switches off	Overheating	Allow the heater to cool. To reset the display, interrupt the 12 V power supply to the heater and switch it back on again

Fault	Cause	Remedy
Heater running, but no heat at the convectors	Circulating pump does not work	Switch on room thermostat
		Contact customer service
Heater and circulating pump running, but no heat at the convectors	Air in the heating system	Bleed hot-water heater

14.6 Air conditioning unit

14.6.1 Dometic

Fault	Cause	Remedy
Air conditioning unit does not start up	No 230 V power supply	Connect the vehicle to the local power supply
	230 V automatic circuit breaker has triggered	Switch on the 230 V automatic circuit breaker
	Remote control batteries empty	Change remote control batteries
Air conditioning unit does not cool	Temperature below 16 °C	–
	Temperature has been set incorrectly	Adjust the temperature
	Thermostat defective	Contact customer service
Air conditioning unit does not warm up	Temperature above 30 °C	–
	Temperature has been set incorrectly	Adjust the temperature
	Thermostat defective	Contact customer service
Water is entering the vehicle	Drainage holes for condensation are clogged	Clean air conditioning unit
	Seal is defective	Contact customer service
No more air circulation	Air filter clogged	Clean air filter
	Fan wheel defective	Contact customer service

14.6.2 Telair

Fault	Cause	Remedy
Air conditioning unit does not start up	No 230 V power supply	Connect 230 V power supply
	230 V automatic circuit breaker has triggered	Switch on the 230 V automatic circuit breaker
	Remote control batteries empty	Change batteries (2 x AAA)
Air conditioning unit does not cool	Room temperature is lower than the preset temperature	Reset temperature

Fault	Cause	Remedy
Air conditioning unit does not heat	Room temperature is higher than the preset temperature	Reset temperature
Insufficient ventilation rating	Ventilation flaps closed	Open at least one ventilation flap
	Filter dirty	Clean the filter
Water is entering the vehicle	Drainage holes for condensation are clogged	Clean air conditioning unit

14.7 Cooker

14.7.1 Gas cooker/gas oven

Fault	Cause	Remedy
Ignition fuse does not operate (flame does not burn after the control knobs are released)	Heat-up time is too short	Keep control knob pressed for approx. 15 to 20 seconds after ignition
	Ignition fuse is defective	Contact customer service
Flame extinguishes when being reduced to its minimum setting	Thermocouple sensor is incorrectly set	Correctly reset thermocouple sensor (do not bend). The sensor tip should protrude by 5 mm beyond the burner. The sensor neck should not be more than 3 mm away from the burner ring; if necessary, contact customer service

14.7.2 Microwave oven



- Only qualified personnel may repair the microwave oven. Improper repairs can cause major risks to the user.

Fault	Cause	Remedy
Microwave oven does not cut in	Fuse is defective	Replace fuse
	Door of the microwave oven is not properly closed	Remove foreign bodies stuck in the door of the microwave oven and close door properly

14.8 Refrigerator

In the event of a defect contact the nearest customer service workshop of the relevant appliance manufacturer. The list of addresses is enclosed with the accompanying appliance documentation. Only authorised qualified personnel may repair the appliance.

14.8.1 Dometic 8 series with MES



▷ In the case of a fault the LED display fault will always light up "⚠".

Fault	Cause	Remedy
LED "⚡" flashes	No 230 V power supply	Connect 230 V power supply
	230 V automatic circuit breaker has triggered	Switch on the 230 V automatic circuit breaker
	230 V operating voltage too low	Have the 230 V power supply checked by an authorised specialist workshop
LED "⚡" flashes	Fuse on the transformer/rectifier is defective	Replace fuse on the transformer/rectifier
	Disconnecter relay in the transformer/rectifier is defective	Contact customer service
	12 V operating voltage too low	Have the 12 V power supply checked by an authorised specialist workshop
LED "🔥" flashes	Lack of gas	Open regulator tap and gas isolator tap
		Connect a full gas bottle
	Cobwebs or burnt residue in the burning chamber	Remove the ventilation grill on the outside of the vehicle and clean the burning chamber
LEDs for display of the temperature range flash	Temperature sensor defective	Contact customer service
LED "⚡" and LEDs for display of the temperature range flash	230 V heater element defective	Contact customer service
LED "⚡" and LEDs for display of the temperature range flash	12 V heater element defective	Contact customer service

14.8.2 Dometic 8 series with AES



▷ In the case of a fault the LED display fault will always light up "⚠".

Fault	Cause	Remedy
Text "230 V" flashes	No 230 V power supply	Connect 230 V power supply
	230 V automatic circuit breaker has triggered	Switch on the 230 V automatic circuit breaker
	230 V operating voltage too low	Have the 230 V power supply checked by an authorised specialist workshop
Text "12 V" flashes	Fuse on the transformer/rectifier is defective	Replace fuse on the transformer/rectifier
	Disconnecter relay in the transformer/rectifier is defective	Contact customer service
	12 V operating voltage too low	Have the 12 V power supply checked by an authorised specialist workshop
Text "GAS" flashes	Lack of gas	Open regulator tap and gas isolator tap Connect a full gas bottle
	Cobwebs or burnt residue in the burning chamber	Remove the ventilation grill on the outside of the vehicle and clean the burning chamber
LEDs for display of the temperature range flash	Temperature sensor defective	Contact customer service
Text "HE1" flashes	230 V heater element defective	Contact customer service
Text "HE2" flashes	12 V heater element defective	Contact customer service

14.9 Thetford refrigerator

Error code	Cause	Remedy
1	The 230 V power supply is 75 % under the required operating voltage	Contact customer service
2	The 12 V power supply is 75 % under the required operating voltage	Contact customer service
3	The refrigerator is operated at 230 V, even though no 230 V mode has been selected	Contact customer service

Error code	Cause	Remedy
4	The refrigerator is operated at 12 V, even though no 12 V mode has been selected	Contact customer service
5	The refrigerator is operated in gas operation mode even though gas operation mode has not been selected	Contact customer service
6	The gas valve has been identified as open even though it should be closed	Contact customer service
7	The gas valve has been identified as closed even though it should be open	Contact customer service
8	The 230 V power supply is 20 % under the required operating voltage	Check 230 V power supply
9	The gas supply has been cut off. The flame has not been ignited within 30 seconds in gas operation mode	<ul style="list-style-type: none"> ● Check the gas supply ● Repeat ignition 3 to 4 times ● Contact customer service
10	The refrigerator is set to 12 V mode and the vehicle engine is not running	Start the vehicle engine or select a different energy source
11	The refrigerator is set to "AUTO" mode and no energy source is available	Provide an energy source and reset the refrigerator. Switch the refrigerator off and on again for this purpose
12	–	Contact customer service
13	The temperature sensor is defective	Check whether the plug is inserted properly above the fin inside the refrigerator. If so: Contact customer service
14	The connection between operating controls and control device is interrupted	Contact customer service

14.10 Water supply

Fault	Cause	Remedy
Leakage water inside the vehicle	A leak has occurred	Identify leak, re-connect water pipes
No water	Water tank is empty	Replenish drinking water
	Drain cock not closed	Close drain cock
	12 V power supply switched off	Switch 12 V power supply on
	Fuse of the water pump is defective	Replace fuse on the transformer/rectifier
	Water pump defective	Exchange water pump (have it exchanged)
	Water pipe snapped off	Straighten water pipe or replace
	Transformer/rectifier defective	Contact customer service
	Water pump switched off on panel	Switch water pump on
Toilet has no flush water	Water tank is empty	Replenish drinking water
	Fuse for toilet is defective	Replace fuse
Display for water and waste water indicates a wrong value	Measuring probe in the waste water or water tank is soiled	Clean water/waste water tank
	Measuring probe is defective	Replace measuring probe
Waste water tank cannot be emptied	Drain cock is clogged	Open the cleaning cap on the waste water tank and drain the waste water. Rinse the waste water tank well
Drain on the single lever mixer tap is clogged	Perlator calcified	Unclip the perlator, de-calcify in vinegar water (only for products made from metal)
Water jets on the shower nozzle clogged	Water jets calcified	De-calcify shower nozzle in vinegar water (only for products made from metal) or rub off soft nozzle burling
Water drains from the shower tray slowly or does not drain at all	The vehicle is not in a horizontal position	Position the vehicle horizontally
Milky water	Tank filled with dirty water	Clean water tank mechanically and chemically; then disinfect and rinse copiously with drinking water
	Residues in the water tank or water system	Clean water system mechanically and chemically; then disinfect and rinse copiously with drinking water

Fault	Cause	Remedy
Any change in the taste or odour of the water	Tank filled with dirty water	Clean water system mechanically and chemically; then disinfect and rinse copiously with drinking water
	Fuel filled into the water tank by mistake	Clean water system mechanically and chemically; then disinfect and rinse copiously with drinking water. If not successful: Contact a specialist workshop
	Microbiological deposits in the water system	Clean water system mechanically and chemically; then disinfect and rinse copiously with drinking water
Deposits in the water tank and/or water-carrying components	Water excessively long in the water tank and in water-carrying components	Clean water system mechanically and chemically; then disinfect and rinse copiously with drinking water

14.11 Body

Fault	Cause	Remedy
Flap hinges/door hinges are difficult to operate	Flap/door hinges are not sufficiently lubricated	Lubricate flap hinges/door hinges with acid-free and resin-free grease
Hinges/joints in the bathroom unit/toilet compartment are difficult to operate/make a grating noise	Hinges/joints are not sufficiently lubricated	Lubricate hinges/joints with solvent-free and acid-free grease  ▷ Spray cans often contain solvents
Storage compartment hinges are difficult to operate/make a grating noise	Storage compartment hinges are not sufficiently lubricated	Lubricate storage compartment hinges with acid-free and resin-free grease
Wind-up skylight is difficult to operate	Threaded spindle not lubricated	Lubricate threaded spindle
	Threaded spindle defective	Have threaded spindle replaced



- ▷ The authorised dealers and service centres are available for any spare parts requirement.

15.1 Weight details for special equipment



- ▶ The use of accessories, parts and fittings not supplied by us may cause damage to the vehicle and jeopardize road safety. Even if an expert's report, a general type approval or a design certification exists, there is no guarantee for the proper quality of the product.
- ▶ Every alteration of the original condition of the vehicle can alter road behaviour and jeopardize road safety.
- ▶ No liability can be assumed for damage caused by products which have not been released by us. This also applies to impermissible alterations to the vehicle.

Weight details for factory-provided special equipment are listed in the table below. If these objects are either carried in or on the vehicle and are not part of the standard equipment, they must be taken into consideration when calculating the payload.

All weight details are approximate.

Observe the max. permissible gross weight.

Item designation	Surplus weight (kg)
Waste water pipes insulated and heated	2
Waste water tank, heated with heating coils	1
Airbag (front passenger)	3
Alloy wheel rims	-15
Caravan coupling	40
Caravan coupling, detachable	30
Dashboard upgrade	2
Conversion door, single-section (with window)	30
Single-section conversion door with window and insect screen	30
External shower	1
External mirrors, electric	2
External socket	1
Automatic transmission	17
Car radio and CD	1
Fuel cell	8
Heki skylight midi	8
Skyroof skylight	12
Roof rail	5
Three-point seat belts in opposite direction to direction of travel (2 x)	30
Extractor hood	1
Electrical stability program (ESP)	3
Spare wheel with 15" support	20
Spare wheel with 16" support	21
External gas connection	1

Item designation	Surplus weight (kg)
Bike rack for 2 bicycles	10
Bike rack for 2 bicycles, lowerable	18
Bike rack for 3 bicycles	11
Bike rack for 3 bicycles, lowerable	20
Roman shade, driver's cabin	4
Floor warming unit	4
Gas oven	17
Gas bottle (11 kg) made of aluminium	12
Gas alarm system	5
Rear window	3
Rear garage door, left	3
Rear ladder	10
Alde heater	30
Truma Combi 6 EH heater	3
Truma D altitude kit	1
Pull-down bed, electrically operated	-
Insect screen, door (full height)	4
Air conditioning unit (Dometic)	40
Driver's cabin air conditioning unit	18
Air conditioning unit (Telair)	34
Fuel tank 120 l	50
Refrigerator (160 l)	14
Refrigerator (Tec-Tower)	16-30
Wind-up skylight (Heki 3)	15
L-seating group	10
Alternator 180 Ah	2
Pneumatic spring	79
Pneumatic spring, rear	45
Awning 260 cm	27
Awning 300 cm	28
Awning 350 cm	33
Awning 400 cm	38
Awning 450 cm	41
Microwave oven	14
Minisafe	12
Central seating group, convertible into bed	2
Motorcycle rack	38
Motorcycle rack in the rear garage	12
Navigation system	1

Item designation	Surplus weight (kg)
Fog light	4
Guest bed	2
Parking distance control	1
Radio preparation	4
Reversing camera	4
Satellite unit (automatic) + LCD television	14–25
Satellite unit (semi-automatic) + LCD television	10
Seat, variable height	2
Solar installation 1 x 100 W	10
Solar installation 2 x 100 W	20
Special paint finish	-
Independent vehicle heater	3
Storage compartment, larger (due to lowered rear)	12
Steadies, electrically operated	20
Rear steadies	5
Bedsread	2
Telescopic ladder	10
Tempomat	3
Carpet in driver's cabin	2
Carpet in the living area	3
Switching facility, gas	2
Adjustment mechanism bench (Reliner)	14
Winter insulation mat, outside	3
Auxiliary battery	27
Auxiliary heat exchanger (heater) for body	3
Two cross beams and slip protection for roof racks	3

16.1 View of ground plans

Explanations

- (1) 230 V fuse
- (2) Transformer/rectifier with 12 V fuses
- (3) Living area battery with main fuse
- (4) Water pump mounted in the tank area
- (5) Drain cock, waste water tank
- (6) Safety/drainage valve
- (7) Boiler/heater
- (8) Water drain cock - yellow
- (9) Water tank
- (10) Additional heater (partially special equipment)
- (11) Water drain cock - white
- * Access via service flap
- ** Beneath the vehicle
- *** Access via kitchen floor cupboard

Specifications without guarantee

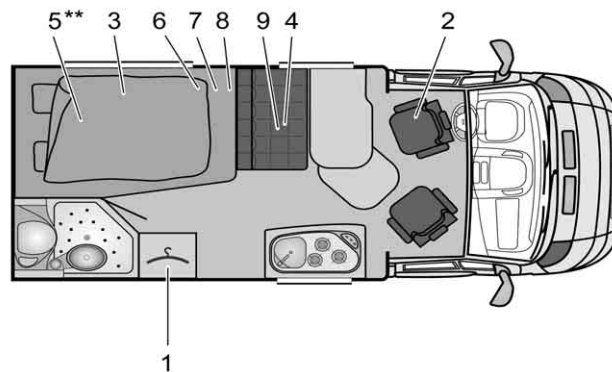

BUE01291

Fig. 299 Ground plan T 569 Nexxo

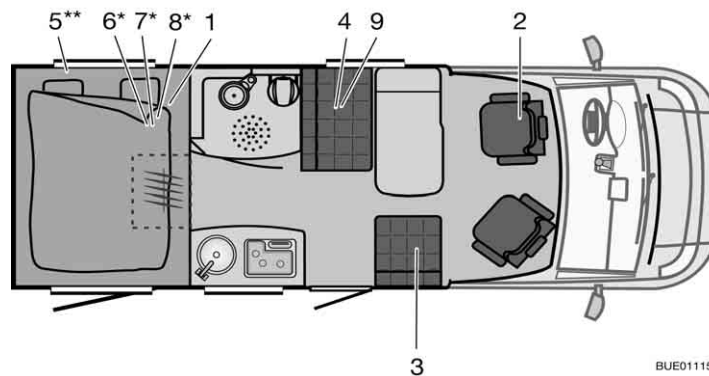

BUE01115

Fig. 300 Ground plan T 571 Travel Van

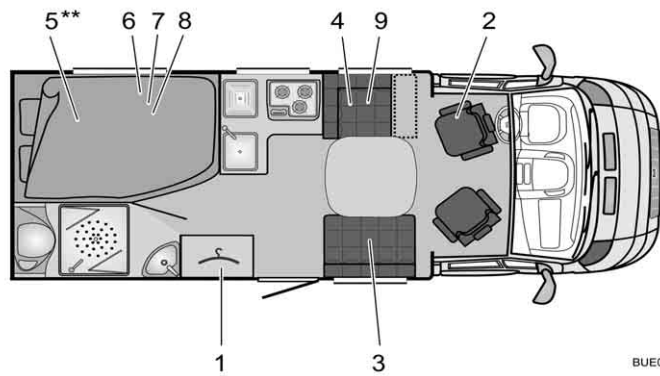

BUE01176

Fig. 301 Ground plan T 580 Nexxo

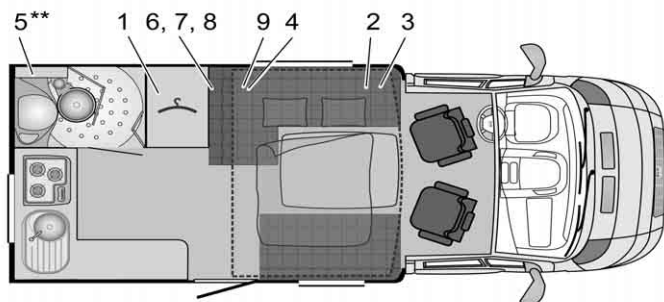

BUE01282

Fig. 302 Ground plan IT 585 Ixeo Time

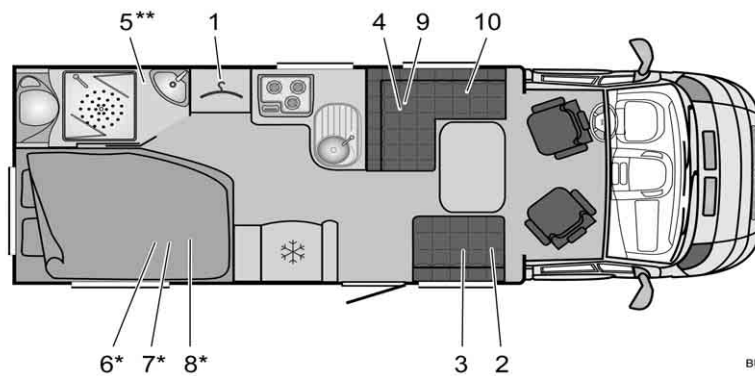

BUE01177

Fig. 303 Ground plan T 615 Solano/Privilège

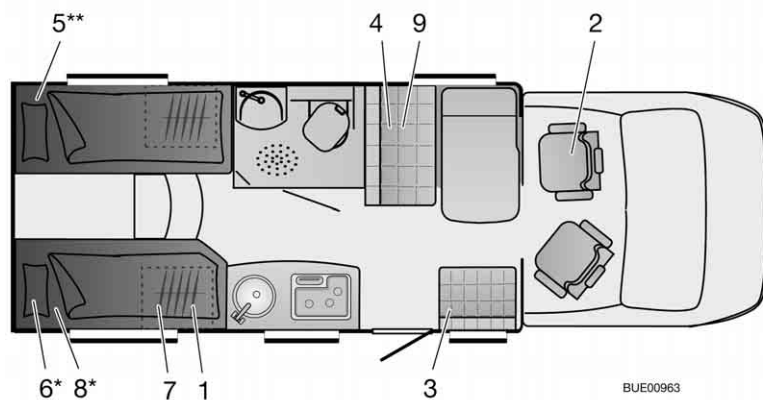

BUE00963

Fig. 304 Ground plan T 620 Travel Van

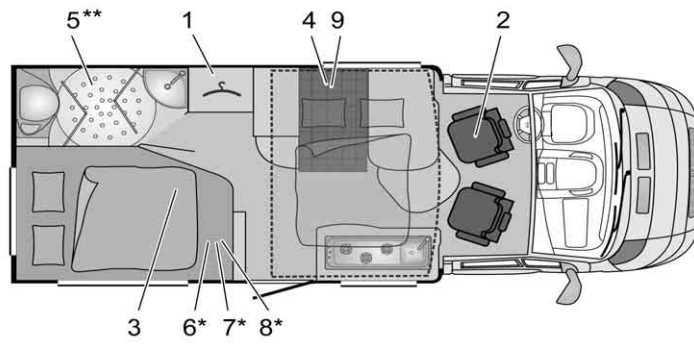

BUE01283

Fig. 305 Ground plan IT 630 Ixeo Time

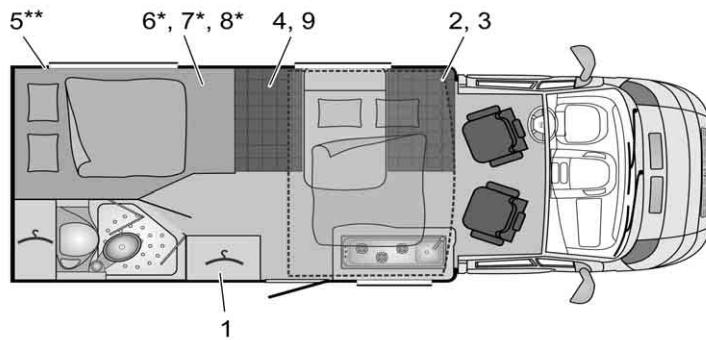

BUE01285

Fig. 306 Ground plan IT 650 Ixeo Time

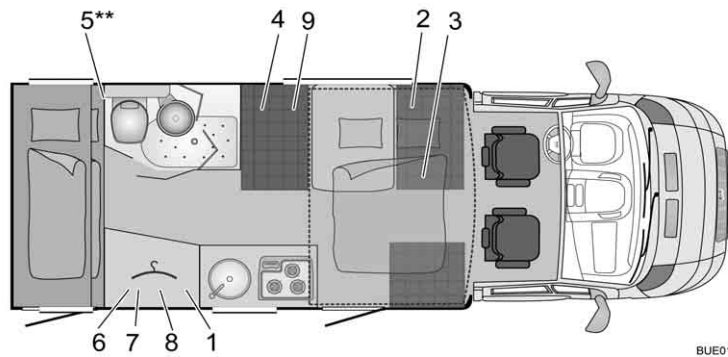

BUE01383

Fig. 307 Ground plan IT 660 Ixeo Time

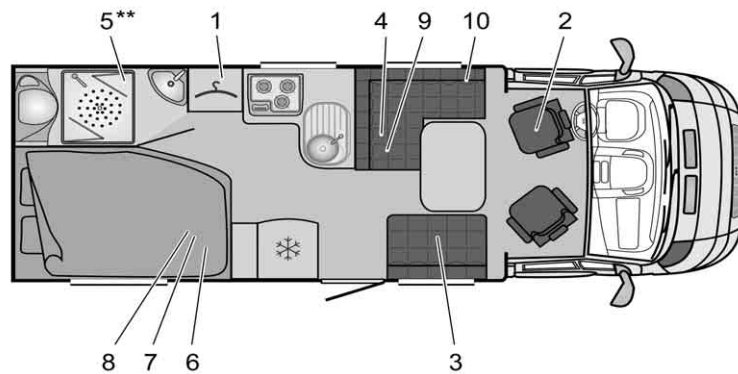

BUE01292

Fig. 308 Ground plan T 660 Nexxo

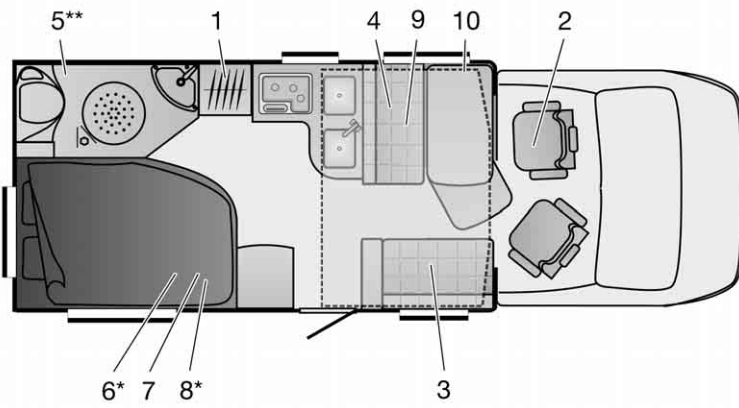

BUE01034

Fig. 309 Ground plan IT 664 Ixeo

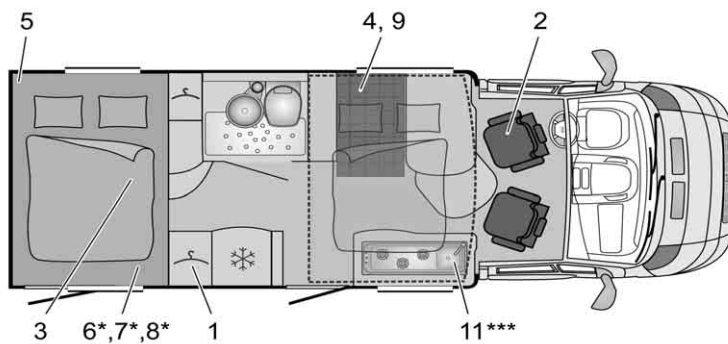

BUE01286

Fig. 310 Ground plan IT 670 Ixeo Time

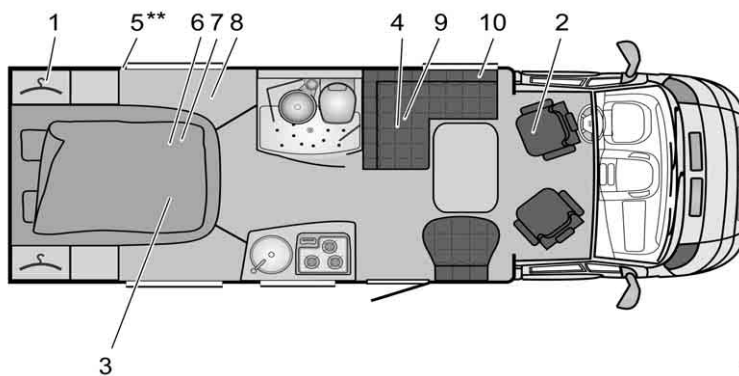

BUE01293

Fig. 311 Ground plan T 687 Nexxo

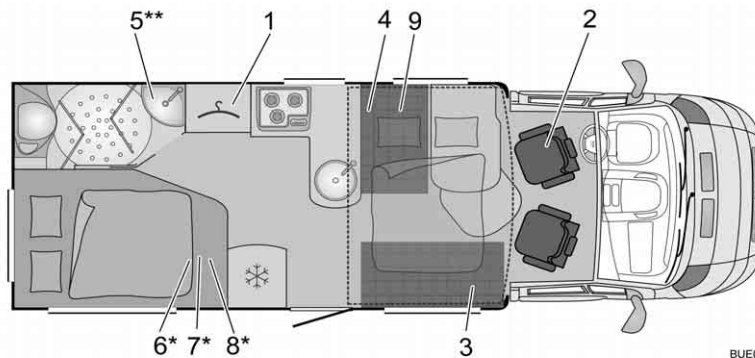

BUE01384

Fig. 312 Ground plan IT 700 Ixeo

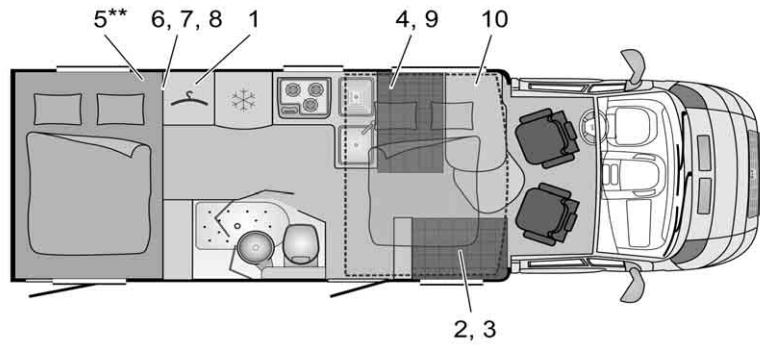

BUE01287

Fig. 313 Ground plan IT 710 Ixeo

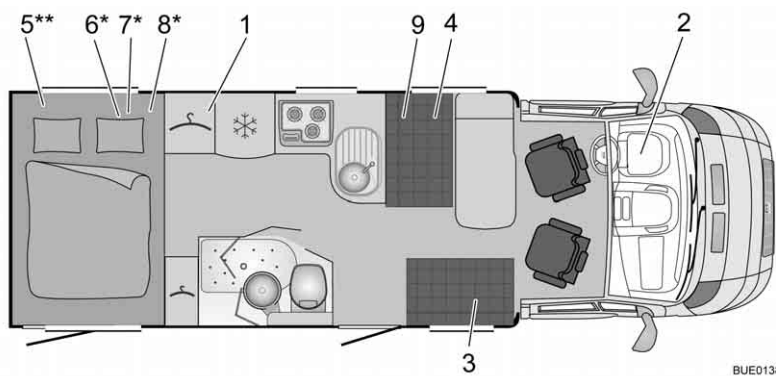

BUE01385

Fig. 314 Ground plan T 715 Nexxo

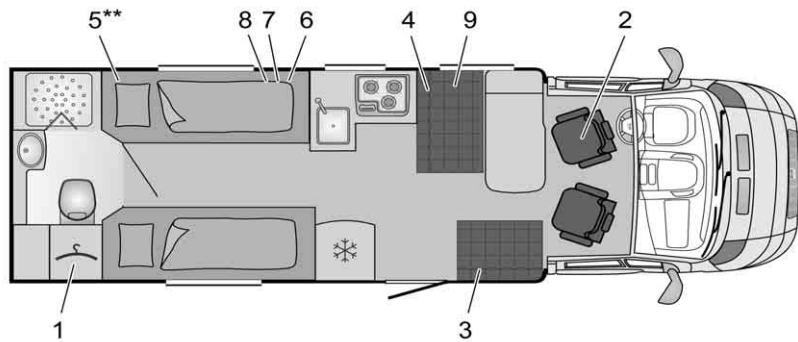

BUE01288

Fig. 315 Ground plan T 720 Nexxo

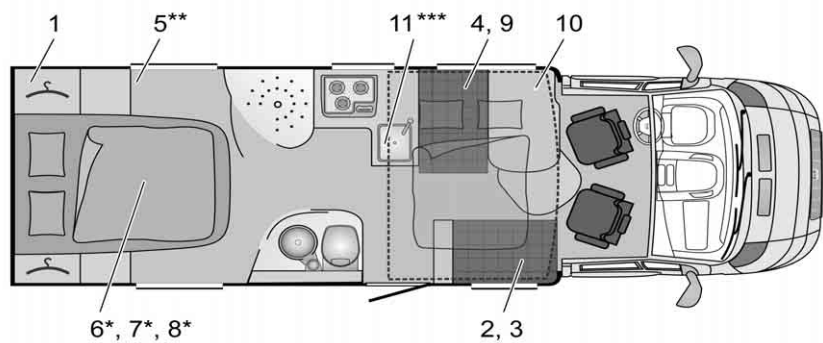

BUE01289

Fig. 316 Ground plan IT 720 Ixeo Time

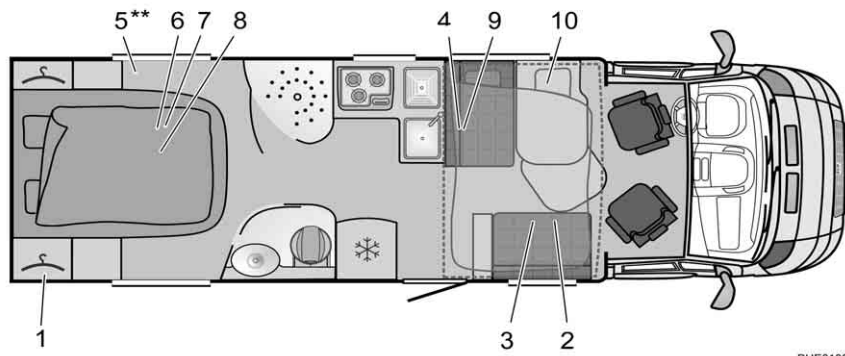

BUE01394

Fig. 317 Ground plan IT 724 Ixeo Plus

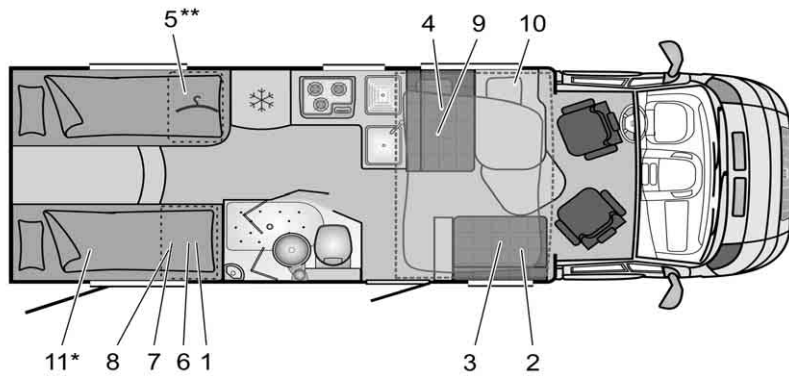

BUE01183

Fig. 318 Ground plan IT 726 Ixeo/Ixeo Plus

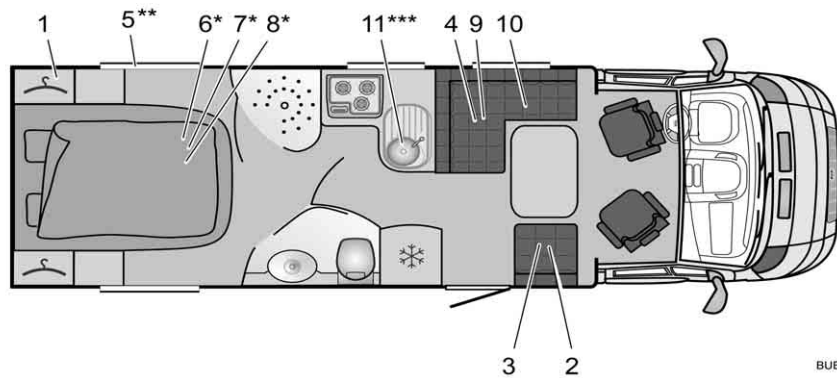

BUE01184

Fig. 319 Ground plan T 727 Solano/Privilège

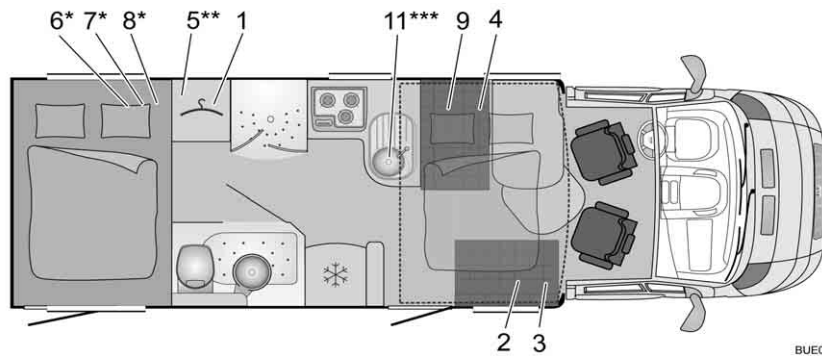

BUE01386

Fig. 320 Ground plan IT 728 Ixeo Plus

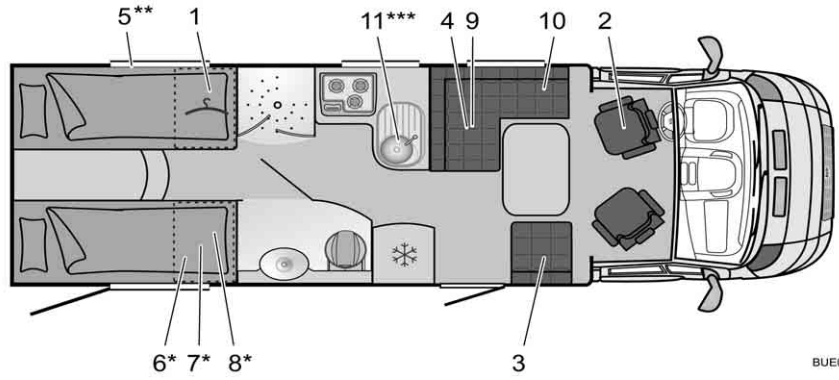

BUE01294

Fig. 321 Ground plan T 728 Nexxo

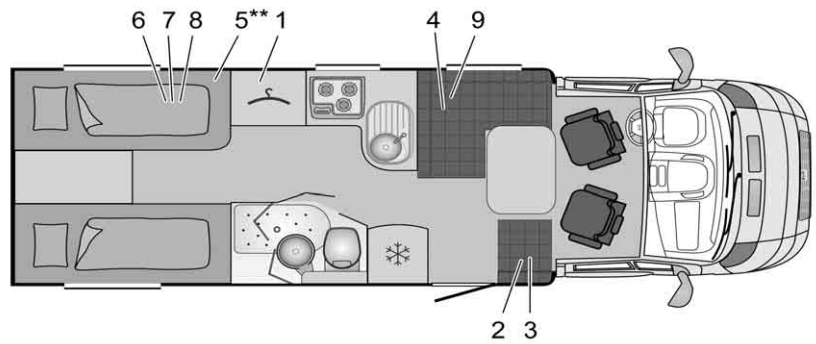

BUE01290

Fig. 322 Ground plan T 729 Solano/Privilège

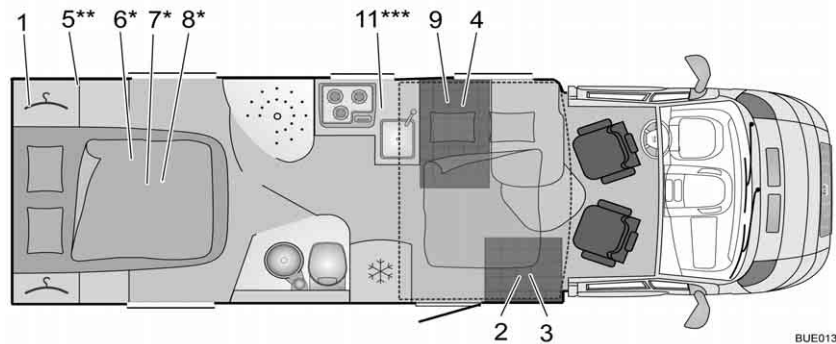

BUE01387

Fig. 323 Ground plan IT 734 Ixeo Time

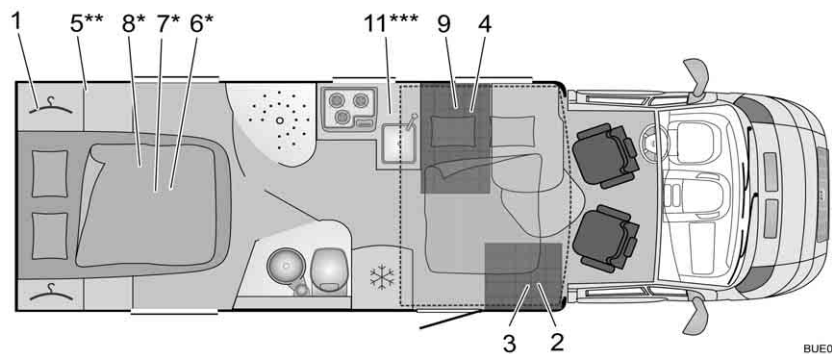

BUE01388

Fig. 324 Ground plan IT 735 Ixeo

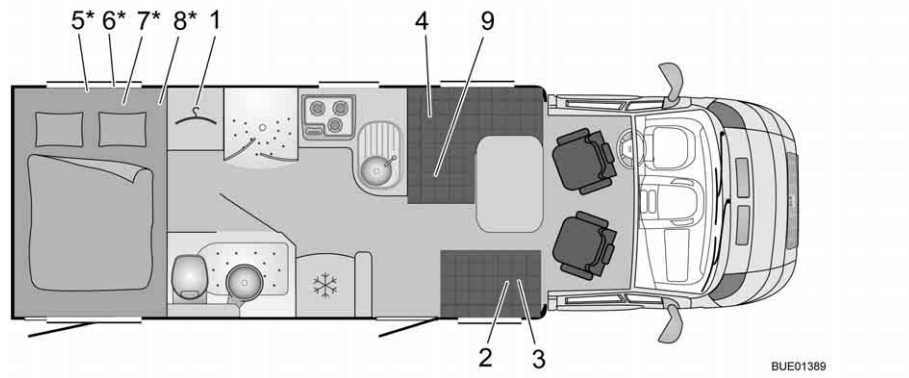

BUE01389

Fig. 325 Ground plan T 736 Solano/Privilège

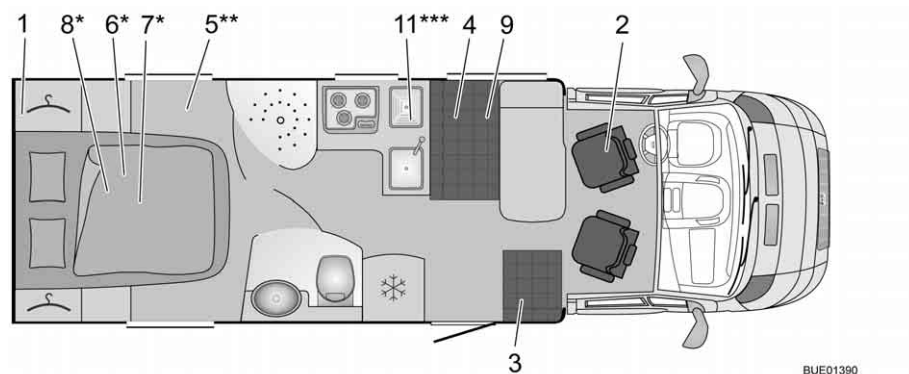

BUE01390

Fig. 326 Ground plan T 740 Nexxo

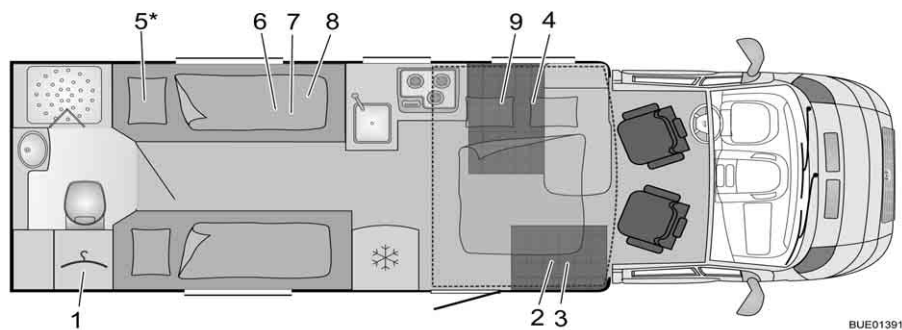

BUE01391

Fig. 327 Ground plan IT 740 Ixeo

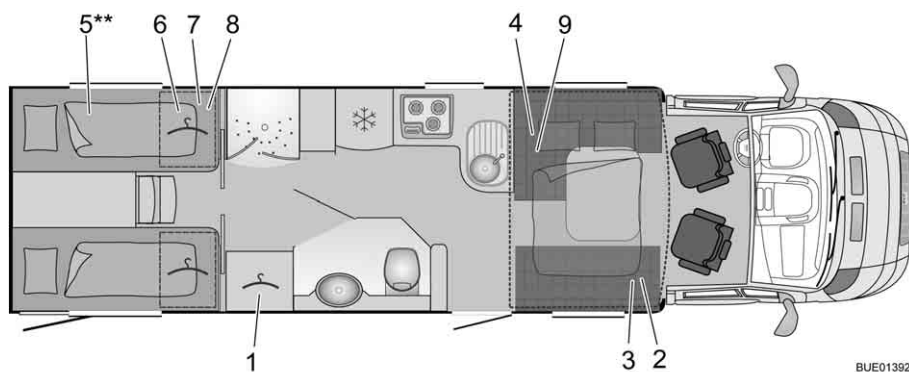

BUE01392

Fig. 328 Ground plan IT 875 Ixeo Plus

16.2 Table of linear measures

Type	Body width, exterior	Total length without ladder ¹⁾	Wheelbase	Overall height without antenna
T 569	2300	5690	3450	2750
T 571	2200	6160	3450	2850
T 580	2300	6240	3800	2750
IT 585	2300	5990	3800	2750
T 615	2300	6930	3800	2750
T 620	2200	6600	3450	2850
IT 630	2300	6350	3800	2750
IT 650	2300	6540	3800	2750
T 660	2300	6790	3800	2750
IT 660	2300	6700	3800	2750
IT 664	2300	6740	3800	2750
IT 670	2300	6740	3800	2750
T 687	2300	6890	3800	2750
IT 700	2300	7040	4035	2750
IT 710	2300	7140	4035	2750
T 715	2300	7140	4035	2750
T 720	2300	7440	4035	2750
IT 720	2300	7390	4035	2750
IT 724	2300	7600	4600	2850
IT 726	2300	7400	4035	2850
T 727	2300	7500	4100	2750
T 728	2300	7440	4035	2750
IT 728	2300	7470	4035	2850
T 729	2300	7450	4100	2750
IT 734	2300	7390	4035	2750
IT 735	2300	7390	4035	2750
T 736	2300	7460	4035	2750
T 740	2300	7390	4035	2750
IT 740	2300	7390	4035	2750
IT 875	2300	8760	4600	2850

¹⁾ = With ladder + 70 mm

16.3 Power supply

Mains connection	Protection class I	230 V ($\pm 10\%$), 47 - 63 Hz
Mains power rating		400 VA
Appropriate batteries	6-cell lead acid and lead acid gel batteries from 55 Ah	
Charging characteristics	IUoU	
Final charge voltage		14.3 V
Charging current	18 A throughout entire supply voltage range, electronically restricted	18 A
Trickle charge voltage	Automatic switching	13.8 V
Repeated charging cycle (switchover to "Main charging")	At < approx. 13.8 V battery voltage (with approx. 5 seconds delay)	
Reflux (without mains and with connected battery)	After approx. 3 minutes "Mains Off"	< 0.3 mA
Guard circuits	Short-circuit protection provided by built-in car fuse (FKS)	
	Safety fuse, 3.15 AT at power input	
	Overtemperature protection	
Charging current distribution at mains connection	Starter battery float charge with max. 2 A	Max. 2 A
	Living area battery charge with max. 18 A	Max. 18 A
Charging current distribution during the journey	Simultaneous charging of starter and living area batteries by means of the alternator	50 A
	Parallel battery switching via disconnecter relay	
	Maximum permitted alternator charging current to the living area battery: 50 A (see block diagram)	
Battery monitor	Disconnection	10.5 V \pm 0.1 V
Battery monitor	Minimum voltage for connection	11.0 V \pm 0.1 V

Chapter overview

This chapter contains helpful tips for the journey.

The instructions address the following topics:

- road assistance in European countries
- traffic rules in European countries
- gas supply in European countries
- toll regulations in European countries
- safe ways to spend the night during travel
- camping in winter

At the end of the chapter there is a checklist containing the most important equipment for the journey.

17.1 Traffic rules in foreign countries



- ▷ The vehicle driver is required to inform himself as to the traffic rules of the countries in which he plans to travel before beginning the trip. Contact your automobile club or embassy for further information.
- ▷ In some European countries, warning vests must be worn when exiting the vehicle outside of towns in the case of vehicle failures or accidents.

Information about traffic regulations is especially important as state law applies in case of damage. For your own safety, always observe the following rules when travelling abroad:

- Take the green insurance card with you.
- Always register accidents with the police.
- Never sign documents that you have not read and understood completely.

17.2 Help on Europe's roads

Country	+ Emergency services ★ Police	☎ Breakdown service
Belgium	+ 112 ★ 112	☎ TCB Brussels 0 70 34 47 77
Bulgaria	+ 150 ★ 166	☎ UAB (02) 9 11 46/146 ¹⁾
Denmark	+ 112 free of charge ★ 112 free of charge	☎ FDM 45 27 07 07
Germany	+ 112 ★ 110	☎ ADAC 22 22 22 ¹⁾
Estonia	+ 112 ★ 110/112 ¹⁾	☎ EESTI (0) 6 97 91 88/18 88 ¹⁾
Finland	+ 112 ★ 112	☎ Helsinki (09) 77 47 64 00
France	+ 15/112 ¹⁾ ★ 17/112 ¹⁾	☎ Lyon (08) 25 80 08 22

Country	+ Emergen- cy services ★ Police	☎ Breakdown service
Greece	+ 112 ★ 171/112 ¹⁾	☎ ELPA 104 00
Great Britain	+ 112 ★ 112	☎ AA (08 00) 0 28 90 18
Ireland	+ 999/112 ¹⁾ ★ 999/112 ¹⁾	☎ AA Dublin 18 00 66 77 88
Iceland	+ 112 ★ 112	☎ F.I.B 5 11 21 12
Italy	+ 118/112 ¹⁾ ★ 112	☎ ACI 8 00 11 68 00
Croatia	+ 112 ★ 112	☎ HAK 9 87/ 0 19 87 ¹⁾
Latvia	+ 03/112 ¹⁾ ★ 02/112 ¹⁾	☎ LAMB 18 88
Lithuania	+ 03/112 ¹⁾ ★ 02/112 ¹⁾	☎ LAS 8 80 00 00 00/18 88 ¹⁾
Luxembourg	+ 112 ★ 113/112 ¹⁾	☎ ACL 2 60 00
Macedonia	+ 194 ★ 192	☎ AMSM +389 2 31 81 196
Montenegro	+ 94 ★ 92	☎ AMSCG 19807
Netherlands	+ 112 ★ 112	☎ ANWB (088) 2 69 28 88
Norway	+ 113 ★ 112	☎ NAF 0 85 05
Austria	+ 144/112 ¹⁾ ★ 133/112 ¹⁾	☎ ÖAMTC 120
Poland	+ 999/112 ¹⁾ ★ 997/112 ¹⁾	☎ PZM 022 5 32 84 33
Portugal	+ 112 ★ 112	☎ ACP Lissab. (21) 9 42 91 03 ACP Porto (22) 8 34 00 01
Romania	+ 961/112 ¹⁾ ★ 955/112 ¹⁾	☎ ACR (021) 2 22 22 22
Russia	+ 03 ★ 02	☎ RAS 8- (4 95) 7 47 66 66
Sweden	+ 112 ★ 112	☎ (08) 6 90 38 00
Switzerland	+ 144 ★ 117/112 ¹⁾	☎ TCS 1 40/03 18 50 53 11 ¹⁾

Country	+ Emergency services ★ Police	☎ Breakdown service
Serbia	+ 94 ★ 92	☎ AMSS 987
Slovakia	+ 112 ★ 112	☎ SATC 1 81 24
Slovenia	+ 112 ★ 113	☎ AMZS (1) 9 87/ 00386 1 5 30 53 53 ¹⁾
Spain	+ 061/112 ¹⁾ ★ 112	☎ RACE 9 15 93 33 33
Czech Republic	+ 112 ★ 112	☎ UAMK CR 12 30
Turkey	+ 112 ★ 155/112 ¹⁾	☎ TTOK (02 12) 2 82 81 40
Ukraine	+ 03 ★ 02	☎ 112 UA (8-032) 2 97 65 50
Hungary	+ 104/112 ¹⁾ ★ 107/112 ¹⁾	☎ MAK 1 88/(06) 13 45 17 44 ¹⁾
Cyprus	+ 112 ★ 112	☎ AA (022) 31 31 31

¹⁾ In the mobile communication network

Date 07/2010

Specifications without guarantee

17.3 Speed limits and permissible dimensions



► Please always observe the speed limits in the individual countries.

For information, the speed limits (in km/h) and permissible dimensions (in m) of the countries visited most:

Country	Max. dimensions in meters		Gross weight	In built-up areas	Outside built-up areas	Motorway
	Width	Lgth.				
Belgium	2.55	12	Up to 7.5 t	50	90/120 ¹⁾	120
			Over 7.5 t	50	60/90 ¹⁾	90
Bulgaria	2.60	12	Up to 3.5 t	50	90	130
			Over 3.5 t	50	70	100
Denmark	2.55	12	Up to 3.5 t	50	80	130
			Over 3.5 t	50	70	80

Country	Max. dimensions in meters		Gross weight	In built-up areas	Outside built-up areas	Motorway
	Width	Lgth.				
Germany	2.55	12	Up to 3.5 t	50	100	130 ³⁾
			3.5 t up to 7.5 t	50	80	100
			Over 7.5 t ²⁾	50	80	80
Estonia	2.50	12	Up to 3.5 t	50	90	110
			Over 3.5 t	50	70	70
Finland	2.60	12		50	80 ⁴⁾	80 ⁴⁾
France	2.55	12	Up to 3.5 t	50	90 ^{5)/-}	130 ⁵⁾
			Over 3.5 t	50	80 ^{5)/} 100 ^{1) 5)}	110 ⁵⁾
Greece	2.50	12		50	90/110 ¹¹⁾	120
Great Britain	2.55	12		48	96/112 ¹⁾	112
Ireland	2.55	12		50	60/100 ¹⁾	120
Iceland	2.55	12		50	90 ⁶⁾	–
Italy	2.50	12	Up to 3.5 t	50	90/	130 ⁷⁾
			Over 3.5 t	50	110 ^{1) 7)} 80	100
Croatia	2.55	12		50	90/110 ¹⁾	130
Latvia	2.50	12	Up to 7.5 t	50	90/100 ¹¹⁾	110
			Over 7.5 t	50	80	80
Lithuania	2.50	12	Up to 3.5 t	50	90	110
			Over 3.5 t	50	70	70
Luxembourg	2.55	12	Up to 3.5 t	50	90 ^{8) 7)}	130 ^{8) 7)}
			Over 3.5 t	50	75 ⁷⁾	90 ⁷⁾
Macedonia	2.50	12		40/60	80	80
Montenegro	2.50	12	Up to 3.5 t	50	80/100 ¹⁾	100
			Over 3.5 t	50	80	80
Netherlands	2.55 ⁹⁾	12	Up to 3.5 t	50	80/100 ¹⁾	120
			Over 3.5 t	50	80	80
Norway	2.55	12.40	Up to 3.5 t	50	80/90 ¹⁾	90
			Over 3.5 t	50	80	80
Austria	2.55	12	Up to 3.5 t	50	100	130 ¹⁰⁾
			Over 3.5 t	50	70	80
Poland	2.50	12	Up to 3.5 t	50	90/100 ¹⁾	130
			Over 3.5 t	50	70/80 ¹⁾	80
Portugal	2.50	12	Up to 3.5 t	50	90/100 ¹¹⁾	120 ¹²⁾
			Over 3.5 t	50	80/90 ¹¹⁾	110 ¹²⁾

Country	Max. dimensions in meters		Gross weight	In built-up areas	Outside built-up areas	Motorway
	Width	Lgth.				
Romania	2.50	12	Up to 3.5 t	50	80/90 ¹⁾	120
			Over 3.5 t	50	80/90 ¹⁾	110
Russia	2.50	12	Up to 3.5 t	60	90 ¹³⁾	110 ¹³⁾
			Over 3.5 t	60	70	90 ¹³⁾
Sweden	2.60	24 ¹⁴⁾	Up to 3.5 t	50	70-	110
			Over 3.5 t	50	110 ^{1) 11)} 80/90 ¹⁾	90
Switzerland	2.55	12	Up to 3.5 t	50	80/100 ¹⁾	120
			Over 3.5 t ¹⁵⁾	50	80/100 ¹⁾	100
Serbia and Montenegro	2.50	12	Up to 3.5 t	60	80/100 ¹⁾	100
			Over 3.5 t	60	80	80
Slovakia	2.50	12	Up to 3.5 t	60	90	130
			Over 3.5 t	60	80	80
Slovenia	2.55	12	Up to 3.5 t	50	80/100 ¹⁾	100
			Over 3.5 t	50	80	80
Spain	2.55	12		50	70/80 ¹⁾	90
Czech Republic	2.50	12	Up to 3.5 t	50	90	130
			Over 3.5 t	50	80	80
Turkey	2.50	10		50	80	90
Ukraine	2.50	12		60	90 ¹³⁾	110 ¹³⁾
Hungary	2.50	12	Up to 2.5 t	50	90/110 ¹⁾	130
			Over 2.5 t	50	70	80
Cyprus	2.55	12		50	80	100

- 1) On expressways, on roads with more than one lane in each direction
- 2) Vehicles over 7.5 tons max. permissible weight require a tachograph
- 3) Recommended speed: 130 km/h
- 4) Since 1995, for the first time, vehicles up to an unladen weight of 1875 kg and vehicles up to 3.5 t perm gross weight with appropriate equipment (ABS, driver airbag, seat belts on all seats) can drive max. 100 km/h
- 5) On wet roads, reduce speed by 10 km/h, on motorways by 20 km/h
- 6) On unmade roads (gravel): 80 km/h
- 7) In wet conditions, reduce speed by 20 km/h
- 8) Drivers who don't have their driver's licence for the full year, must not drive faster than max. 75 km/h when out of town or 90 km/h on motorways
- 9) On main roads 2.55 m, on roads marked "B" 2.20 m
- 10) Between 10 p.m. and 5 a.m. the speed limit on the following motorways is 100 km/h: A10 (Tauernautobahn), A12 (Inntalautobahn), A13 (Brennerautobahn), A14 (Rheintalautobahn)
- 11) According to traffic signs

- ¹²⁾ Drivers who have had their driver's licence for less than one year must not drive faster than 90 km/h. Corresponding stickers (available from ACP offices) must be affixed in a clearly visible position on the rear of the vehicle
- ¹³⁾ Drivers who have had their driver's licence for less than two years must not drive faster than 70 km/h
- ¹⁴⁾ Swedish campsites often require the motorhome to have a closed waste water system
- ¹⁵⁾ A heavy goods vehicle supplement must be paid on all roads for all vehicles exceeding 3.5 tons max. permissible weight

Date 07/2010

Source: ADAC

Specifications without guarantee

17.4 Driving with low beam in European countries



- ▷ In many European countries, it is compulsory to drive with the vehicle's lights on even during the day. Regulations vary between countries. Motoring organisations or consulates can provide you with the relevant information.

17.5 Sleeping in the vehicle away from camping areas

Country	Sleeping on roads and fields		Sleeping on privately owned lands		Comments
	Yes	No	Yes	No	
Belgium		X	X		On highway rest areas max. 24 hours permitted
Bulgaria		X		X	
Denmark	X		X		On streets and squares only up to 11 hours with a parking disc
Germany	X		X		Staying overnight for one night to restore driving ability is permitted. There may be regional and local limitations
Finland	X			X	Possible with the permission of the land owner
France	X		X		Permission from the local authorities or the owner of the land is required. Parking and staying overnight on free areas is prohibited
Greece		X		X	Staying overnight for one night at designated areas on the national route Patras-Athens-Thessaloniki is permitted
Great Britain		X	X		
Ireland		X	X		

Country	Sleeping on roads and fields		Sleeping on privately owned lands		Comments
	Yes	No	Yes	No	
Italy	X		X		Staying overnight for one night at car parks and service stations is allowed. Observe the local regulations. Parking and staying overnight on free areas is prohibited
Croatia		X		X	
Luxembourg		X	X		
Macedonia		X		X	
Netherlands		X	X		Overnight stays on streets and squares is allowed in some boroughs
Norway	X		X		Officially prohibited on rest areas and cultivated grounds. Travelling on dirt roads is prohibited
Austria	X		X		Staying overnight for one night to restore driving ability is permitted, but not in nature reserves. Observe regional and local restrictions. Generally forbidden in Tyrol
Poland		X	X		Requires property owner's permission
Portugal		X		X	Staying overnight for one night on motorway service stations and car parks under 10 hours are tolerated
Romania		X		X	
Russia		X		X	
Sweden	X		X		Not on agriculture areas or in the vicinity of houses. Driving on open fields is prohibited
Switzerland		X	X		One overnight stay at highway rest areas and in some cantons is tolerated
Serbia and Montenegro		X		X	
Slovakia	X		X		Overnight stays on private land are only allowed if a toilet is present
Slovenia		X		X	
Spain	X		X		Some regional prohibitions apply, especially on beaches
Czech Republic	X		X		Overnight stays on private land are only allowed if a toilet is present

Country	Sleeping on roads and fields		Sleeping on privately owned lands		Comments
	Yes	No	Yes	No	
Turkey	X		X		
Ukraine	X		X		
Hungary		X	X		Staying overnight on privately owned land is permitted only with police certification

Specifications without guarantee

17.6 Gas supply in European countries



- ▷ In Europe, there are several different connection systems for gas bottles. It is not always possible to fill or exchange your gas bottles in a foreign country. Get information about the connection system in the country you are travelling to before embarking on your journey, e.g. at a motoring club or in the trade press.

General tips

Always observe the following instructions:

- Only go on vacation with completely filled gas bottles.
- Use all of the gas bottles' capacity.
- Take along adapter sets (available in camping supply stores) for filling gas bottles in foreign countries and for connecting the gas pressure regulator to foreign gas bottles.
- During the cold time of the year observe filling with propane gas component (butane does not gas below 0 °C).
- Use blue bottles from the firm Campingaz (distributed world-wide). Only use gas bottles with safety valves.
- When bottles from other countries are used, check the gas bottle compartments to see if the gas bottles fit into them. Gas bottles from other countries do not always display the same size as your own gas bottles.

17.7 Toll regulations in European countries

Many European countries have introduced a mandatory toll system. The toll regulations and how they are collected vary greatly from country to country. Nevertheless, ignorance is no excuse. Penalties can be quite severe.

As is the case with traffic regulations, the vehicle driver is required to be familiar with the toll formalities before starting out on a trip. For example, in Austria the vignette does not meet the toll requirements for vehicles that weigh more than 3.5 t. There, a so-called "Go-Box" must be obtained and charged.

Contact your automobile club or the Internet for further information.



- ▷ Windscreens with solar filters can affect the functioning of automatic toll collection systems (e.g. Go-Box). This must be taken into account when acquiring the appropriate device (e.g. Split-Go-Box).

17.8 Tips on staying overnight safely during travel

Prudent behaviour is the most important protective measure for insuring a safe night in the motorhome.

The risk of thievery is reduced to a minimum when the following basic rules are observed:

- Before commencing the journey, close and lock all windows, doors and skylights.
- During high season do not spend the night at highway rest stops or parking areas located along typical vacation routes.
- Several vehicles on one site at the same time do not necessarily decrease the chances of thievery occurring. Consult your own feelings about the parking site.
- Even if it is just for one night, go to a camping site.
- When parking on open space keep emergency routes clear. The way to the driver's seat should be clear. The ignition key should always be within reach.
- Only take with you those valuables which are absolutely necessary for the journey. If possible, store valuables in a small safe and not in the immediate vicinity of windows or doors.
- Always lock up the vehicle.

17.9 Tips for winter campers

The following tips will help make your winter camping experience as agreeable as possible.

- Reserve your parking place in good time. Good winter camping sites are often booked up early.
- Do not start your trip without winter tyres.
- Bring snow chains.
- Choose your parking place with care. Observe the ground beneath you. Snow and ice may melt.
- When the vehicle has been positioned, release the handbrake to prevent freezing.
- No snow walls should be allowed to cover the built-in forced ventilation.
- Keep the built-in forced ventilation free from snow and ice.
- Make sure the air circulation is good. Good air circulation prevents moisture from collecting and makes it easier to heat the living area.
- Cover the single-paned driver's cabin window with insulation mats to avoid thermal bridges.
- Follow the instructions in the section "Gas supply in European countries".
- Use a two-bottle system with automatic controller for the gas system, so that the supply does not run out during the night.
- Only operate the gas system using propane gas.
- Do not use the space behind the heater as a storage compartment.
- Never operate catalytic ovens or infra-red gas radiators in the interior of the vehicle, since they consume oxygen for burning.
- Lay the 230 V power cable in such a way that the cable cannot be frozen or be damaged (e.g. during snow removal).
- When it is snowing heavily, clear the roof of the vehicle of snow regularly. A few centimetres of powdery snow serves as insulation, but wet snow quickly becomes a heavy burden.
- Before embarking on the return journey, remove all the snow from the roof to avoid impeding vehicles behind you with a "snow flag".

17.10 Travel checklists

The following checklists will help that nothing important is left at home although not everything on the checklists might be necessary.



- ▷ Do not leave checking of documents (e.g. vehicle papers and information) as well as checking the condition of the vehicle until just before commencing the trip. Planning and checking documents well in advance will save unnecessary trouble.

Kitchen area

✓	Object	✓	Object	✓	Object
	Wiping cloth		Cleansing agent (detergent)		Salad servers
	Mug		Dishcloths		Chopping board
	Turnspit		Set of knives and forks for grilling		Bowls
	Can opener		Coffeepot		Brush to wash the dishes
	Egg-cup		Corkscrew		Cloth to wash the dishes
	Ice cube tray		Kitchen paper		Matches
	Lighter		Spoons		Cups
	Bottle opener		Knives		Plates
	Air-tight storage boxes		Garbage bags		Thermos jug
	Breakfast plate		Frying pans		Pots
	Forks		Stirring spoons		Glasses

Bathroom/sanitary items

	Towels		Toilet brush		Toothbrush glass
	Sanitary items		Toilet paper		

Living area

	Dustbin		Insect lamp		Rain clothes
	Road atlas		Insect repellent		First aid kit
	Bath towels		Deck of cards		Travel guides/parking guide
	Bath shoes		Broom		Rucksack
	Batteries		Candles		Sleeping bags
	Bed sheets		Dust pan		Pencils and paper
	Bed linen		Coat-hangers		Shoes
	Laundry bag		Clothes brush		Shoe polish
	Books		Pillow		Vacuum cleaner
	Camping guide		Map		Flash light
	Spare bulbs		Medicine		Pocket knife
	Water bottle		Music cassettes		Table cloth
	Binoculars		Neck-supporting pillow		Clothes pins

✓	Object	✓	Object	✓	Object
	Fire extinguisher		Sewing kit		Clothesline
	Gas bottle		Radio		

Vehicle/tools

	Waste water container		Fabric tape		Screwdriver
	Adapter socket		Watering can for drinking water		Current-measuring instrument
	CEE adapter		Cable reel		Step
	Wire		V-belt		Wheel chocks
	Spare wheel		Glue		First-aid kit
	Spare lamps		Universal pliers		Vehicle jack
	Spare fuses		Compressor		Hazard warning triangle
	Replacement water pump		Luster terminals		Warning sign
	Hammer		Loops		Warning vest
	Flat wrench		Tube adapter		Flashing hazard warning light
	Gas filling adapter		Hose clips		
	Gas tube		Snow chains (winter)		

Outside

	Stay rope		Camping table		Lock
	Bellows		Luggage racks		String
	Camping chairs		Grill		Tent pegs/tightening ropes

Documents

	List of addresses		Registration book		Identity card
	Registration confirmation(s)		Driving licence		Passport
	Allergy certificate		Green insurance card		Writ of protection
	Instruction manuals		Vaccination certificate		Vignette/toll card
	Instruction leaflets for medicines		Credit card		Visa

Pos.	Component	Activity	Interval
1	Auxiliary support	Lubrication	Annually
2	Joints, hinges	Lubrication	Annually
3	Refrigerator, heater, boiler, cooker, lighting, flap and door closures, toilet, seat belts	Function check	Annually
4	Windows, skylights	Function check, water ingress test	Annually
5	Upholstery, curtains, blinds	Visual check	Annually
6	Sealing strips, edges, rubber	Check for damage	Annually
7	Water supply	Water ingress test	Annually
8	Hot-air system	Function check, clean fan wheel as necessary	Annually
9	Underbody protection, floor skirt attachment	Visual check	Annually
10	Pull-down bed suspension	Function check	Annually
11	Electrical system	Function check	Annually
12	Gas system	Official gas inspection	Every two years
13	Connections between the chassis and body	Check	Every two years
14	Underbody	Visual check, repair underbody protection as necessary	Every two years



Delivery _____	Pos. 1-11
Stamp of the Bürstner dealer	
Date	Signature

1st year _____	Pos. 1-11
Stamp of the Bürstner dealer	
Date	Signature

2nd year _____	Pos. 1-14
Stamp of the Bürstner dealer	
Date	Signature

3rd year _____	Pos. 1-11
Stamp of the Bürstner dealer	
Date	Signature

4th year _____	Pos. 1-14
Stamp of the Bürstner dealer	
Date	Signature

5th year _____	Pos. 1-11
Stamp of the Bürstner dealer	
Date	Signature

6th year _____	Pos. 1-14
Stamp of the Bürstner dealer	
Date	Signature

7th year _____	Pos. 1-11
Stamp of the Bürstner dealer	
Date	Signature

8th year _____	Pos. 1-14
Stamp of the Bürstner dealer	
Date	Signature

12 V fuses	137
For Thetford toilet	139
For toilet	140
On the living area battery	138
On the relay box AD01	138
On the starter battery	138
On the transformer/rectifier	138
12 V indicator lamp	127, 131
12 V main switch	124, 130
12 V power supply	118
Switching on	124, 130
Troubleshooting	236
230 V connection	48, 136
External flap	57
Troubleshooting	235
230 V fuse	141
Position	253
230 V fuse box	141
230 V indicator lamp	127, 131
230 V power supply	135

A

Accessories, fitting	10
Additional equipment	18
Add-on parts see special equipment	10
Add-on parts, securing	31
Adjustable head section, fixed bed	84
Adjustment mechanism, divan	83
Air conditioning unit (Dometic)	
Air current, adjusting	160
Care	208
LED	160
Maintenance	208
Operating modes	159
Switching off	160
Switching on	159
Troubleshooting	241
Air conditioning unit (Telair)	
Care	208
Filter, cleaning	208
Operating modes	161
Switching off	161
Switching on	161
Troubleshooting	241
Ventilation grill, cleaning	209
Air outlet nozzles, adjustment	148
Antenna alignment	50
Automatic	48
Semi-automatic	49

Antenna, lowering for driving	50
Appliances	147
Manuals	10
Warranty cards	1
Automatic power selection (AES)	176
Automatic power selection (SES)	178
Auxiliary heat exchanger	
Switching off	157
Switching on	157
Awning	50

B

Basic equipment	17
Battery alarm	126, 129
Battery cut-off switch	123
Battery monitor	123
Battery see starter battery or living area battery	119, 120
Battery selector switch	123
Battery voltage, displaying	124, 127
Bed extension, securing	31
Bed widening, single beds	92
Beds	84
Before the journey	15
Bike rack	
Bicycles, loading	24, 25
Load	23
Lowerable	24
Not lowerable	25
Travelling with a loaded bike rack	23
Blind, cleaning	206
Blind, window	
Closing	69
Opening	69
Block diagram, panel (IT 96)	144
Block diagram, panel (IT 994)	145
Boiler (Alde)	
Emptying	167
Safety instructions	167
Switching off	167
Switching on	167
Troubleshooting	240
Water, filling with	167
Boiler (Truma)	162, 165
Emptying	164, 166
Operating modes	162, 165
Position	253
Safety/drainage valve	163, 165
Summer operation	163, 166

Switching off	164, 166	PVC-floor covering	206
Switching on	163, 166	Roman shade	206
Troubleshooting	238, 239	Seat belt	206
Water, filling with	164, 166	Sink	206
Winter operation	163, 166	Synthetic parts, interior	205
Brakes	38	Temporary lay-up	210
Check	39, 235	Underbody	204
Braking system, troubleshooting	235	Upholstery	205
Breakdown services in Europe	263	Washing	204
Bulbs, changing	219	Waste water tank	205
Exterior lighting	219	Water system	206
Garage light	225	Windows	204
Halogen spotlight	223, 224	Winter lay-up	211
Interior lighting	221	Carpet, cleaning	206
Rear lights	220	Central bench, sleeping	
Recessed halogen light	222, 223	conversion	98, 99, 100
Side lights	220	Central seating group, sleeping	
Types of external bulbs	221	conversion	95, 96
Wardrobe light	224	Changing wheels	229
Bunk bed	86	Tightening torque	230
Butane gas	13, 108	Charging condition, displaying	
		Living area battery	124
		Starter battery	124
		Charging current	130
		Chassis number	226
		Checklist	32, 210
		Before the journey	32
		For the journey	272
		Initial start-up after temporary lay-up	212
		Road safety	32
		Temporary lay-up	210
		Winter lay-up	211
		Child restraint systems	39
		Children's beds	86, 87, 88
		Circuit diagram	
		Exterior	146
		Interior	143
		Circulating pump, setting the rotational	
		speed	154
		Circulation fan	148
		Cleaning	
		Water pipes	206
		Water tank	206
		Cleaning see care	203
		Closed circuit current	117
		Condensation	65
		On the double acrylic glass pane	66
		On the screwed connections in the	
		floor	65
		Condensation water see condensation	66
C			
Cable reel	136		
Camping gas bottles, use	14, 108		
Camping in winter	271		
Cap for the drinking water filler neck	58		
Capacity of the battery	118		
Caravan coupling	27, 28		
Care	203		
Air conditioning unit (Telair)	208		
Blind	206		
Carpet	206		
Curtains	206		
Entrance step	205		
External care	203		
Extractor hood	208		
Fuel cell	206		
Furniture surfaces	205		
Gas cooker	206		
High-pressure cleaner, washing with	203		
Hot-water heater	217		
In the winter	209		
Insect screen	206		
Interior care	205		
Lamps	205		
Leather covers	206		
Net curtains	206		

- Connecting cable see 230 V power supply . . . 136
Conventional load 17
Conversion door 53, 55
 Roman shade, closing 55
 Roman shade, opening 55
Conversion door, inside
 Locking 54, 55
 Opening 54, 55
Conversion door, outside
 Locking 53, 54
 Opening 53, 54
Converting seating group into bed 92
Cooker 168
 Troubleshooting 242
Curtains, cleaning 206
- D**
- Danger of suffocation 10, 65
Digital clock
 Setting 129
 Switching off 129
 Switching on 129
Dimensions see table of linear measures 261
Dimensions, permissible 265
Direction indicator 220
Discharging current 130
Displays
 Battery voltage 124, 127
 Current 130
 Digital clock 129
 Temperature 129
 Waste water tank level 126, 128
 Water tank level 126, 128
Disposal
 Household waste 8
 Sewage 8
 Waste water 8
Divan adjustment mechanism 83
Door lock 53, 54
Doors
 Conversion door 53
 Lock 53, 54
 Maintenance work 215
 Troubleshooting 247
Drain cock, waste water tank 186
 Position 253
Drain cocks, position 168, 253
- Drinking water filler neck 184
 Closing 184
 Opening 184
Driver's seat 40
Driving speed 38
Driving the motorhome 35
DuoControl switching facility 113
During the journey 35
- E**
- Electrical steady legs
 Remote control 46
 Warning tone 46
Electrical system 117
 230 V connection, troubleshooting 235
 Entrance step, troubleshooting 235
 Explanation of terms 117
 Lighting, troubleshooting 235
 Safety instructions 14
 Troubleshooting 235
Entrance step 28, 43
 Care 205
 Electrically operated 29
 Extending 30
 Free-standing 28
 Indicator lamp 29, 30
 Retracting 30
 Troubleshooting 235
Environmental tips 8
Exterior lighting
 Bulbs, changing 219
 Checking 32
 Troubleshooting 235
External care 203
External connection see 230 V connection 48
External flaps 56
 Flap lock 56, 57
External gas connection 110
External socket 142
Extractor hood 173
 Care 208
 Filter, cleaning 208
- F**
- Fault current protection switch 136
 Check 141
Filling level of the waste water tank,
displaying 126
Filling level of the water tank, displaying 126

Filling the tank	42	Fuel filler neck	42
Fire		Furniture flaps	58
Behaviour in the event of	9	Closing	59
Extinguishing	9	Opening	58, 59
Fire prevention	9	Furniture flaps, troubleshooting	247
Fire risks, avoidance	9	Furniture surfaces, cleaning	205
FI-switch see fault current protection		Fuse box	141
switch	141	Fuses	
Fixed bed	84	12 V fuses	137
Closing	84	230 V fuse	135, 141
Head section, lowering	85	For the Thetford toilet	139
Head section, raising	84	For toilet	140
Opening	84	On the living area battery	138
Fixed bed, electrically adjustable	85	On the relay box AD01	138
Emergency operation	86	On the solar charge regulator	140
Extending	85	On the starter battery	138
Head section, adjusting	85	On the transformer/rectifier EBL 99	138
Retracting	85	Fuses see 12 V fuses and 230 V fuse	137
Fixed table	81		
Extending	81	G	
Moving in a crossways direction	82	Garage light	225
Moving in a lengthways direction	82	Gas alarm system	114
Reducing size	81	Gas bottle compartment	13, 108
Flap lock		Gas bottles	
Closing	57, 58	Changing	109
Opening	56, 57, 58	Safety instructions	13, 108
Service flap	57	Gas connection, external	110
With recessed handle	56	Gas cooker	
Flat screen with holder	62	Cleaning	206
Positioning	63, 64	Switching off	169, 170
Storing	63, 64	Switching on	169
Floor warming unit, electrical		Troubleshooting	242
Overload protection	158	Gas isolator taps	110
Switching off	158	Symbols	110, 147
Switching on	158	Gas odour	12, 107, 238
Forced ventilation	10, 65	Gas oven	170
Front passenger's seat	40	Switching off	171
Fuel cell		Switching on	171
Cleaning	206	Troubleshooting	242
Components	132	Gas supply in European countries	270
Function	132	Gas system	107
Instructions	131	Defect	12, 107, 238
Maintenance	216	General instructions	12
Operating status, indication	133	Safety instructions	12, 107
Operating unit	133	Switching automatics	111, 113
Position	132	Troubleshooting	238
Process medium, refilling	217	Gas tube, check	13, 108
Tank cartridge, replacing	216	General instructions	7
Troubleshooting	237	Ground plans	253

H	
Halogen spotlight	223, 224
Handbrake	43
Applying	10
Handling of tyres	229
Headrests	40
Heat exchanger	
Switching off	157
Switching on	157
Heat exchanger (Alde)	
Position	155
Switching off	155
Switching on	155
Heat exchangers, heater, replacement	147
Heater	148
Air outlet nozzles, adjustment	148
Circulation fan	148
Heat exchangers, replacement	147
Hot air distribution	148
Initial start-up	148
Troubleshooting	238
Heki skylight	73
Closing	74
Insect screen	74
Opening	74
Roman shade	74
Ventilation position	74
Help on Europe's roads	263
High rate of gas consumption	12, 107, 238
High-pressure cleaner, washing with	203
Hinged window	67
Blind	69
Closing	66, 68
Continuous ventilation	67, 68
Insect screen	69, 70, 71
Opening	66, 68
Roman shade	70
Hot air distribution	148
Hot-air heater	
Circulation fan	148
Operating modes	149, 151
Position	253
Switching off	150, 152
Switching on	149, 151
Troubleshooting	238, 239
Hot-water heater	
230 V electrical operation, selecting	154
Adjustment menu	153
Auxiliary circulating pump	156
Care	217
Fluid level, checking	218
Gas and 230 V electrical operation, selecting	154
Gas operation, selecting	154
Heat exchanger	155
Heater, switching off	154
Heater, switching on	154
Heating fluid, topping up	218
Heating system, bleeding	218
Maintenance work	217
Operating unit	152
Rotational speed, circulating pump	154
Safety instructions	152
Start screen	153
Tool menus	153
Troubleshooting	240
I	
Independent vehicle heater	
Maintenance	219
Programming	159
Switching off	158
Switching on	158
Indicator lamp, 12 V power supply	127, 131
Indicator lamp, 230 V power supply	127, 131
Indicator lamp, entrance step	30
Indicator lamp, toilet	201
Information stickers	226
Inner door, troubleshooting	247
Insect screen door	
Closing	56
Opening	56
Insect screen, cleaning	206
Insect screen, Heki skylight	
Closing	74
Opening	74
Insect screen, Skyroof skylight	
Closing	77
Opening	77
Insect screen, windows	
Closing	69, 70, 71
Opening	69, 70, 71
Insect screen, wind-up skylight	
Closing	75
Opening	75
Inspection plan	275
Inspection work	215
Inspections	215

Index

- Interior care 205
- Interior lighting
- Bulbs, changing 221
 - Troubleshooting 235
- K**
- Keys 15
- L**
- Ladder, rear 21
- Lamps 221
- Cleaning 205
- Lay-up
- Temporary 210
 - Winter lay-up 211
- Leakage water inside the vehicle 246
- Leather covers, cleaning 206
- Lift-off table
- Conversion to bed foundation 81
 - Table-top, moving in a crossways
direction 80
 - Table-top, moving in a lengthways
direction 80
 - Table-top, moving upwards 81
- Light switch
- Living area 60
 - Toilet compartment 60
- Lighting
- Front 220
 - Lamps, cleaning 205
 - Rear 220
 - Side 220
 - Troubleshooting 235
- Living area battery 120
- Battery alarm 126, 129
 - Charging 121
 - Charging current, displaying 130
 - Discharging current, displaying 130
 - Fuses 138
 - Instructions 120
 - Maintenance work 216
 - Position 253
 - Troubleshooting 236, 237
 - Voltage, displaying 124, 127
- Load 19
- Bike rack 23
 - Rear garage 22
 - Rear storage space 22
 - Roof rack 21
- Load rack 25, 26
- Load rack for roof loads 21
- Load see also payload 19
- Lock
- Conversion door 53, 54
 - External flap 56, 57
 - Furniture flap 58
- Low beam 220, 268
- L-shaped bench,
sleeping
conversion 101, 102, 103, 104, 105, 106
- M**
- Main beam 220
- Maintenance 215
- Maintenance work 215
- Air conditioning unit (Dometic) 208
 - Air conditioning unit (Telair) 208
 - Doors 215
 - Fuel cell 216
 - Hot-water heater 217
 - Independent vehicle heater 219
 - Living area battery 216
- Marker light 221
- Mass in ready-to-drive condition 17, 19
- Maximum permissible gross weight 16, 19
- Mechanical steady legs
- Extending 44, 45
 - Length, adjustment 44, 45
 - Retracting 45
- Microwave oven
- Switching off 172
 - Switching on 172
 - Troubleshooting 242
- Monitor, reversing camera 37
- N**
- Net curtains, cleaning 206
- No gas 238
- Nose weight 27
- O**
- Off-load voltage 117
- Operating modes
- Air conditioning unit (Dometic) 159
 - Air conditioning unit (Telair) 161
 - Boiler (Truma) 162, 165
 - Hot-air heater 149, 151
 - Refrigerator 174, 176

Refrigerator with SES	178	Making ready for operation	89
Switching automatics, gas system	114	Opening	89
Oven see gas cooker or gas oven	168, 170	Overload protection	89
Overloading	19	Retaining belts, tightening	89
P		Pull-down bed, manually operated	86
Panel (IT 96)	124	Access ladder	88
12 V indicator lamp	127	Closing	87
12 V main switch	124	Opening	87
230 V indicator lamp	127	Retaining belts, tightening	87
Battery voltage, displaying	124	PVC-floor covering, cleaning	206
Block diagram	144	R	
Filling level of the waste water tank, displaying	126	Radio	118
Filling level of the water tank, displaying	126	Ramps	43
Switch for water pump	126	Rear axle load	27
Panel (IT 994)	127	Rear garage	22
12 V indicator lamp	131	Rear ladder	21
12 V main switch	130	Rear storage space	22
230 V indicator lamp	131	Recessed halogen light	222
Battery voltage, displaying	127	Refrigerator	48, 173
Block diagram	145	12 V operation, switching on/off	176
Filling level of the waste water tank, displaying	128	230 V operation, switching on/off	176
Filling level of the water tank, displaying	128	Change-over between energy sources	177
Switch for water pump	131	Door lock	180
Panel see also displays	124, 127	Gas operation, switching off	175
Parking distance control	36	Gas operation, switching on	175
Switching off	37	Operating modes	174, 176
Parking light	220	Operation	178
Payload	16	Refrigerating temperature control	178
Calculation	18	Switching off	178
Composition	17	Switching on	178
Example calculation	17, 19	Troubleshooting	243, 244
Payload see also load	16	Ventilation grill, removal	174
Permissible gross weight see maximum		Refrigerator door locking mechanism	
permissible gross weight	16	Closing	181, 182
Permitted mass	16	Locking in the ventilation position	181, 182
Personal equipment	18	Opening	181, 182
Pilot seat see driver's seat and front		Refrigerator ventilation grill, removal	174
passenger's seat	40	Refrigerator with SES	
Power supply	262	Change-over between energy sources	179
Propane gas	13, 108	Operating modes	178
Pull-down bed, electrically operated	88	Refrigerating temperature control	180
Access ladder	90	Undervoltage operation	180
Closing	89	Registration	15
Emergency operation	90	Remote control, electrical steady legs	46
		Replacing the fuel cell tank cartridge	216
		Reversing camera	37
		Risk of frost damage	14, 183, 188

Index

Road safety	32	Safety/drainage valve boiler	163, 165
Checklist	32	Position	163, 166, 253
Notes for	10	Sanitary fittings	183
Roman shade, cleaning	206	SAT socket	142
Roman shade, driver's window		Satellite unit	48, 50
Closing	72	With automatic antenna alignment	48, 50
Opening	72	With semi-automatic antenna alignment	49
Roman shade, front passenger's window		Seat belts	39
Closing	72	Cleaning	206
Opening	72	Fastening correctly	39
Roman shade, Heki skylight		Seating arrangement	41
Closing	74	Seating group with vario seat, sleeping conversion	97
Opening	74	Selector switch for radio	118
Roman shade, Skyroof skylight		Serial number	226
Closing	77	Setting up the bed	92
Opening	77	Sewage tank	
Roman shade, window of conversion door		Emptying	202
Closing	55	Removal	202
Opening	55	Shower	189
Roman shade, windows		Shower partition, securing	31
Closing	70, 71	Side marker light	220
Opening	70, 71	Single beds, bed widening	92
Roman shade, windscreen	41	Sink, cleaning	206
Closing	72	Skylights	73
Opening	72	Skyroof skylight	76
Roman shade, wind-up skylight		Closing	76
Closing	75	Continuous ventilation	76
Opening	75	Insect screen	77
Roof load	21	Opening	76
Roof rack, load	21	Roman shade	77
Roof rail	21	Sleeping conversion	
Roof, climbing	22	Central bench	98, 99, 100
		Central seating group	95, 96
		L-shaped bench	101, 102, 103, 104, 105, 106
		Seating group with vario seat	97
		Sleeping conversion, widening single beds	92
		Snow chains	32
		Sockets	
		External socket	142
		SAT socket	142
		TV socket	142
		Solar charge regulator	134
		Solar installation	134
		Spare parts	225
		Spare wheel	233
		Spare wheel support	233

S

Safety cut-out	141
Safety instructions	9
Changing wheels	229
Cooker	168
Electrical system	14
Fire prevention	9
Gas bottles	108
Gas system	12, 107
Heater	152
Road safety	10
Towing	12
Water system	14
Safety net, pull-down bed	87, 89
Safety switch (FI)	141

Special equipment	249	Thetford cassette	190, 194, 196, 199
Description	7	Emptying	194, 199
Marking	7	Removing	196
Safety instructions	10	Retaining clip	190, 194, 196, 199
Weight details	249	Thetford toilet	
Speed limits	265	Emptying	194, 199
Spotlight	61, 223	Fuse	139
Removing	62	Preparing	190, 196
Shifting	62	Swiveling	190
Turning	61, 62	Using	192, 198
Starter battery	119	With fixed seat	196
Charging	119	Tightening torque, wheels	230
Discharging	119	Tips	263
Fuses	138	Toilet	190
Instructions	119	Fuse	140
Troubleshooting	236	Troubleshooting	246
Voltage, displaying	124, 127	Toilet (Dometic)	200
Start-up		Flushing	201
After temporary lay-up	212	Indicator lamp	201
After winter lay-up	212	Preparing	200
Staying overnight		Toilet compartment	189
Away from camping areas	268	Light switch	60
During travel	271	Ventilation	189
Steady legs	44, 45	Toilet see Thetford toilet or toilet (Dometic) . . .	190
Extending	44, 45	Toll regulations in European countries	270
Length, adjustment	44, 45	Total discharge	118
Retracting	45	Towing	12
Step (rear bed)	91	General instructions	27
Supports see steady legs	44, 45	Safety instructions	12
Suspension table	78, 80	Traffic rules in foreign countries	263
Conversion to bed foundation	79, 80	Transformer/rectifier (EBL 99)	121
Extending	79	Circuit diagram	143
Reducing size	79	Functions	122
Switching automatics, gas system	111, 113	Position	122
Symbols		Transformer/rectifier, position	253
For instructions	7	Travel checklists	272
Gas isolator taps	110, 147	Travel cots suitable for children	86, 87, 88
Synthetic parts in the toilet and living areas, cleaning	205	Troubleshooting	235
		12 V power supply	236
		230 V connection	235
		Air conditioning unit (Dometic)	241
		Air conditioning unit (Telair)	241
		Battery	236
		Body	247
		Boiler (Alde)	240
		Boiler (Truma)	238, 239
		Braking system	235
		Cooker	242
		Electrical system	235
T			
Table of linear measures	261		
Tables	78		
Tank lid see fuel filler neck	42		
Technical data			
Dimensions	261		
Power supply	262		
Television	30		
Temperature display	129		

Entrance step	235
Extractor hood	237
Fuel cell	237
Furniture flaps	247
Gas cooker	242
Gas oven	242
Gas system	238
Heater	238
Hot-air heater	238, 239
Hot-water heater	240
Inner door	247
Lighting	235
Living area battery	236
Microwave oven	242
Refrigerator	243, 244
Starter battery	236
Toilet	246
Water supply	246
TV socket	142
Tyre change see changing wheels	229
Tyre specifications	229
Tyres	227
Excessive wear	11, 32, 227, 233
General instructions	227
Handling	229
Identification	229
Load-carrying capacity	230
Tyre pressure	233
Tyre selection	228
 U	
Underbody, maintenance	204
Unladen weight	17
Upholstery, cleaning	205
 V	
Vehicle identification plate	226
Vehicle lighting see exterior lighting	219
Vehicle, washing	204
Ventilation	65
Toilet compartment	189
Volume of waste water, displaying	126, 128
Volume of water, displaying	126, 128
 W	
Wardrobe light	61, 224
Warning stickers	226
Warning tone, electrical steady legs	46
Warranty cards	1
Washing with a high-pressure cleaner	203
Waste gas vent on the right hand side of the vehicle.	148, 162
Waste water hose	186
Waste water tank	186
Care	205
Cleaning	205
Cleaning opening	186
Emptying	186
Filling level, displaying	126, 128
Troubleshooting	246
Waste water tank heater	187
Water pipes, cleaning	206
Water pump	183, 187
Position	253
Switch	126, 131
Water supply	
General	183
Troubleshooting	246
Water system	
Care	206
Cleaning	206
Disinfect	207
Drinking water filler neck	184
Emptying	188
Filling	187
Safety instructions	14
Water tank	184
Cleaning	206
Filling	185
Filling level, displaying	126, 128
Overflow	185
Position	253
Volumes	184
Water, draining	185
Water, filling with	185
Weight details for special equipment	249
Wheel chocks	43
Wheel rim size	230
Wheel rim type	227
Wheels	227
Window, conversion door	
Roman shade, closing	55
Roman shade, opening	55
Windows	65
Blind	69
Insect screen	69, 70

Roman shade	70, 71
Shade	71
Windows, cleaning	204
Wind-up skylight	75
Closing	75
Insect screen	75
Opening	75
Roman shade	75
Troubleshooting	247
Winter care	209
Winter operation	209

