

Dear Reader ...

We would like to congratulate you on the purchase of your new motorhome. You have selected a top-quality vehicle which will afford you many years of enjoyment.

To enable you to always use and operate your motorhome properly and easily, your Bürstner dealer will first provide you detailed instructions for all important functions when you take delivery.

This manual, the instruction manuals from the base vehicle manufacturer as well as the instruction manuals from the appliance manufacturer will always be at hand to answer any questions you may have regarding your motorhome.

Before your first journey

Please familiarise yourself with this manual rather than relying on it strictly for reference.

Fill in the warranty cards for the appliances and special equipment in the individual instructions and send these cards to the respective manufacturers. This ensures your warranty claim for each appliance.



1	Introduction.....	7	5.5.1	General instructions.....	43
1.1	General.....	8	5.5.2	Rear axle air suspension.....	44
1.2	Environmental tips.....	8	5.5.3	Front and rear axle air suspension.....	46
2	Weatherproof guarantee.....	11	5.6	Seat belts.....	49
2.1	Bürstner Warranty Conditions.....	11	5.6.1	General.....	49
2.2	Proof of water ingress tests.....	13	5.6.2	Fastening the seat belt correctly.....	49
2.2.1	Vehicle data.....	13	5.7	Child restraint systems.....	50
2.2.2	Water ingress test (certificates).....	14	5.8	Pilot seats for the driver's and front passenger's seats.....	51
3	Safety.....	15	5.9	Seat heater (special equipment).....	52
3.1	Fire prevention.....	15	5.10	Headrests.....	52
3.1.1	Avoidance of fire risks.....	15	5.11	Seating arrangement.....	53
3.1.2	Fire-fighting.....	15	5.12	Roman shade in the driver's cabin.....	53
3.1.3	In case of fire.....	15	5.12.1	Pleated Roman shades.....	53
3.2	General.....	16	5.12.2	Roman shades, Remis (special equipment).....	54
3.3	Road safety.....	16	5.13	Refuelling.....	54
3.4	Towing.....	18	6	Setting up the vehicle.....	55
3.5	Gas system.....	18	6.1	Handbrake.....	55
3.5.1	General instructions.....	18	6.2	Entrance step.....	55
3.5.2	Gas bottles.....	20	6.3	Ramps.....	55
3.6	Electrical system.....	20	6.4	Wheel chocks.....	55
3.7	Water system.....	21	6.5	Supports.....	55
4	Before the journey.....	23	6.5.1	General instructions.....	55
4.1	Keys.....	23	6.5.2	Steady legs (AL-KO) (partially special equipment).....	56
4.2	Registration.....	23	6.6	230 V connection.....	56
4.3	Payload.....	23	6.7	Refrigerator.....	57
4.3.1	Terms.....	24	6.8	Satellite unit (special equipment).....	57
4.3.2	Calculating the payload.....	26	6.9	Satellite unit with manual satellite selection (TeleSat).....	58
4.3.3	Loading the vehicle correctly.....	27	6.10	Satellite unit with automatic antenna alignment (Teleco).....	59
4.3.4	Rear garage/rear storage space.....	29	6.11	Satellite unit with automatic antenna alignment (Oyster Premium).....	60
4.3.5	Double floor.....	29	6.12	Awning (special equipment).....	62
4.3.6	Bike rack (special equipment).....	30	7	Living.....	63
4.3.7	Bike/e-bike bike rack (special equipment).....	32	7.1	Central locking system (special equipment).....	63
4.3.8	Removable load rack AL-KO (special equipment).....	33	7.2	Conversion door.....	64
4.4	Towing.....	34	7.2.1	Conversion door, outside.....	64
4.5	Caravan coupling (special equipment).....	35	7.2.2	Conversion door, inside.....	65
4.6	Electrically operated entrance step.....	36	7.2.3	Window of conversion door (partially special equipment).....	65
4.7	TV unit (special equipment).....	37	7.2.4	Folding insect screen on the conversion door (partially special equipment).....	66
4.8	Securing add-on parts.....	38	7.3	External flaps.....	66
4.9	Snow chains (special equipment).....	39	7.3.1	Flap lock with recessed handle.....	67
4.10	Road safety.....	39	7.3.2	Flap lock, square.....	67
5	During the journey.....	41	7.3.3	Garage flap emergency release.....	68
5.1	Driving.....	41	7.3.4	Flap lock with push button.....	68
5.2	Reversing camera (partially special equipment).....	42	7.3.5	Flap for the 230 V connection, square.....	69
5.3	Driving speed.....	42			
5.4	Brakes.....	43			
5.5	Air suspension (special equipment).....	43			

Contents

7.3.6	Cap for the drinking water filler neck.	69	9	Electrical system	109
7.4	Furniture flaps and inner doors	70	9.1	General safety instructions	109
7.4.1	Furniture flaps with push button	70	9.2	Terms	109
7.4.2	Furniture flaps with release handle.	70	9.3	USB socket	110
7.4.3	Furniture flaps with handle and push button	71	9.4	12 V power supply.	111
7.4.4	Floor compartment cover	71	9.4.1	Selector switch for radio (special equipment).	111
7.4.5	Driver's cabin partition	72	9.4.2	Starter battery	112
7.5	Light switch	73	9.4.3	Living area battery.	113
7.5.1	Entrance area	73	9.4.4	Charging batteries via a 230 V power supply	115
7.5.2	Interior	73	9.4.5	Charging batteries via the vehicle engine	115
7.6	Spotlight	74	9.5	Transformer/rectifier (EBL 223).	115
7.7	Light control.	75	9.5.1	Battery separation.	117
7.8	Holder for flat screen	77	9.5.2	Battery selector switch	117
7.8.1	Holder on the column.	77	9.5.3	Battery monitor	117
7.9	Ventilation	77	9.5.4	Charging the battery.	118
7.10	Windows	78	9.5.5	Entrance step	118
7.10.1	Hinged window	79	9.5.6	Solar charge regulator	118
7.10.2	Blind and insect screen	81	9.6	Panel LT 511	118
7.10.3	Roman shade and insect screen.	82	9.6.1	230 V indicator lamp	119
7.10.4	Roman shades for windscreen, driver's window and front passenger's window	83	9.6.2	12 V main switch	120
7.11	Skylights	84	9.6.3	Batteries gauge.	120
7.11.1	Heki skylight (mini and midi) (partially special equipment)	85	9.6.4	Tank gauge.	122
7.11.2	Wind-up skylight (partially special equipment)	87	9.6.5	Alarms	122
7.11.3	Omni-Vent skylight with fan (special equipment).	88	9.6.6	Temperature display	123
7.11.4	Skyroof skylight	89	9.6.7	Switch for water pump	123
7.12	Suspension table	91	9.7	Solar installation (special equipment).	124
7.13	Divan adjustment mechanism.	93	9.8	230 V power supply	125
7.14	Additional seat	94	9.8.1	230 V connection (CEE socket outlet)	125
7.15	Beds	94	9.8.2	Connecting the 230 V power supply	126
7.15.1	Overcab bed.	94	9.9	Fuses.	127
7.15.2	Fixed bed (adjustable head section)	96	9.9.1	12 V fuses.	127
7.16	Converting seating groups for sleeping.	96	9.9.2	230 V fuse	130
7.16.1	Central seating group.	96	9.10	External socket (special equipment).	131
7.17	Shower connection point for external shower (special equipment).	97	9.11	Circuit diagrams	132
8	Gas system	99	9.11.1	Circuit diagrams, interior	132
8.1	General	99	9.11.2	Circuit diagram, exterior	135
8.2	Gas bottles	101	10	Appliances	137
8.3	Gas isolator taps.	102	10.1	General	137
8.4	External gas connection (special equipment).	103	10.2	Heater	138
8.5	Gas bottle switching facility (special equipment).	104	10.2.1	Models with waste gas vent on the right-hand side of the vehicle	138
8.6	Changing gas bottles	107	10.2.2	Alde hot-water heater	138
			10.2.3	Wall flue	146
			10.2.4	Electrical floor warming unit (special equipment).	146
			10.3	Air conditioning unit (special equipment).	147



10.3.1	Truma Aventa air conditioning unit	147	12.3.2	Cleaning the water pipes	179
10.3.2	Telair	151	12.3.3	Disinfecting the water system	180
10.4	Cooker	152	12.3.4	Cleaning the waste water tank	180
10.4.1	Gas cooker with gas oven and gas grill	152	12.4	Extractor hood	181
10.4.2	Microwave oven (special equipment)	154	12.5	Air conditioning unit	181
10.4.3	Extractor hood (partially special equipment)	155	12.5.1	Truma	181
10.5	Refrigerator	156	12.5.2	Telair	181
10.5.1	Refrigerator ventilation grill	156	12.6	Winter care	182
10.5.2	Dometic MES/AES	157	12.6.1	Preparations	182
10.5.3	Refrigerator door locking mechanism	160	12.6.2	Winter operation	182
			12.6.3	At the end of the winter season	182
			12.7	Lay-up	183
			12.7.1	Temporary lay-up	183
			12.7.2	Winter lay-up	184
			12.7.3	Starting up the vehicle after a temporary lay-up or after lay-up over winter	185
11	Sanitary fittings	163	13	Maintenance	187
11.1	Water supply, general	163	13.1	Official inspections	187
11.2	Water system	164	13.2	Inspection work	187
11.2.1	Water tank	164	13.3	Maintenance work	188
11.2.2	Auxiliary water tank (special equipment)	164	13.4	Doors	188
11.2.3	Drinking water filler neck with cap	165	13.5	Living area battery	188
11.2.4	Filling the water system	165	13.6	Extractor hood	188
11.2.5	Topping up the water	166	13.7	Alde hot-water heater	188
11.2.6	Closing/opening the overflow	167	13.7.1	Checking the fluid level	189
11.2.7	Draining water (rotary handle with overflow)	167	13.7.2	Topping up heating fluid	189
11.2.8	Emptying the water system	168	13.7.3	Bleeding the heating system	190
11.3	Waste water installation	169	13.7.4	Position of the bleeding valves	190
11.3.1	Draining waste water	169	13.8	Replacing bulbs, external	191
11.3.2	Heater for waste water tank and waste water pipes (special equipment)	170	13.8.1	Front lights	191
11.4	Toilet compartment	171	13.8.2	Rear lights	192
11.5	Toilet	172	13.8.3	Side lights	192
11.5.1	Preparing toilet	172	13.8.4	Types of bulbs for exterior lighting	193
11.5.2	Swivel toilet	173	13.9	Replacing bulbs, internal	193
11.5.3	Emptying the sewage tank	174	13.9.1	Halogen ceiling lamp	194
			13.9.2	Recessed lights with LED	194
			13.9.3	Wardrobe light	195
			13.9.4	Surface mounted light	195
			13.10	AL-KO rear axle	196
			13.11	Spare parts	196
			13.12	Vehicle identification plate	197
			13.13	Warning and information stickers	197
12	Care	175	14	Wheels and tyres	199
12.1	External care	175	14.1	General	199
12.1.1	General	175	14.2	Tyre selection	200
12.1.2	Washing with a high-pressure cleaner	175	14.3	Tyre specifications	201
12.1.3	Washing the vehicle	176	14.4	Handling of tyres	201
12.1.4	Windows of acrylic glass	176	14.5	Changing wheels	201
12.1.5	Entrance step	176	14.5.1	General instructions	201
12.1.6	Air suspension	177	14.5.2	Tightening torque	202
12.2	Interior care	177	14.5.3	Changing a wheel	203
12.2.1	Scratch-resistant surface (kitchen worktop and table top) (special equipment)	178			
12.3	Water system	179			
12.3.1	Cleaning the water tank	179			

Contents

14.6	Spare wheel support under the vehicle (special equipment)	204	16	Special equipment.....	221
14.6.1	Spare wheel support under the vehicle (basket).....	204	16.1	Weight details for special equipment	221
14.7	Tyre pressure.....	205	17	Technical data	223
15	Troubleshooting.....	207	17.1	View of ground plans	223
15.1	Braking system	207	17.2	Table of linear measures / sleeping places	223
15.2	Air suspension	207	18	Helpful notes.....	225
15.3	Electrical system	208	18.1	Traffic rules in foreign countries.....	225
15.4	Gas system.....	211	18.2	Help on Europe's roads.....	225
15.5	Heater/boiler	212	18.3	Gas supply in European countries ...	226
15.5.1	Alde heater/boiler	212	18.4	Toll regulations in European countries	226
15.6	Air conditioning unit	213	18.5	Tips on staying overnight safely during travel	227
15.6.1	Truma	213	18.6	Tips for winter campers.....	227
15.6.2	Telair.....	214	18.7	Travel checklists.....	228
15.7	Cooker	214	19	Inspection plan.....	231
15.7.1	Gas cooker/gas oven	214			
15.7.2	Extractor hood	215			
15.7.3	Microwave oven.....	215			
15.8	Refrigerator	216			
15.8.1	General	216			
15.8.2	Dometic MES/AES	217			
15.9	Water supply	218			
15.10	Body	220			

Please read this instruction manual completely before using the vehicle for the first time!

Always keep this instruction manual in the vehicle. Also inform all other users of the safety regulations.



- ▶ The non-observance of this symbol can lead to personal injury.



- ▷ The non-observance of this symbol can lead to damage being caused to, or inside the vehicle.



- ▷ This symbol indicates recommendations or special aspects.



- ▷ This symbol indicates actions which lead to environmental awareness.

This instruction manual contains sections which describe model-specific equipment or special equipment. These sections are specially marked. It may be that your vehicle has not been fitted with this special equipment. In some cases, the actual equipment of your vehicle may therefore be different from that shown in some illustrations and descriptions.

However, your vehicle may be fitted with other special equipment not described in this instruction manual.

Special equipment is described when an explanation is required.

Adhere to the instruction manuals which are separately enclosed.



- ▷ The details "right", "left", "front" and "rear" always refer to the vehicle in direction of travel.
- ▷ All dimensions and weight details are "approximate".

Should the vehicle be subjected to damage due to a failure to follow the instructions in this instruction manual, then the guarantee claim is deemed invalid.

Our vehicles are subjected to continuous development. Please understand that we reserve the right to alter the form, equipment and technology. Therefore, no claims can be made against the manufacturer as a result of the contents of this instruction manual. The equipment which was known and included at the time of going to press is described.

The reprinting, translation and copying, including extracts is not permitted without prior written authorisation from the manufacturer.

1.1 General

The vehicle is constructed in accordance with the latest technology and the recognised safety regulations. Nevertheless, personal injury may result and the vehicle may be damaged if the safety instructions in this instruction manual are not followed.

Before using the vehicle for the first time, equip it with the legally prescribed equipment (e.g. first aid kit, warning vest, hazard warning triangle etc.). Observe the relevant equipment regulations when travelling abroad.

Only use the vehicle in a technically impeccable condition. Follow the instructions in the instruction manual.

Malfunctions which impair the safety of persons or the vehicle should be immediately remedied by qualified personnel. To avoid further damages, observe the duty to avert, minimise or mitigate loss for the user during faults.

Have the vehicle's braking and gas systems inspected and repaired by an authorised specialist workshop only.

Alterations to the body are only to be carried out with the authorisation of the manufacturer.

The vehicle is designed for the exclusive transport of persons. Luggage and accessories may only be transported up to the maximum permissible gross weight.

Observe the test and inspection periods stipulated by the manufacturer.

1.2 Environmental tips



- ▷ Be considerate of the environment.
- ▷ Remember that: All kinds of waste water and household waste are not to be disposed of in drains or in the open countryside.
- ▷ On board, collect waste water only in the waste water tank or – if necessary – in other containers designed for that purpose.
- ▷ Only empty the waste water tank and toilet cassette or sewage tank at disposal stations at the camping or caravan sites, which are especially provided for this purpose. When stopping in towns and communities, observe the instructions at caravan sites or ask where there are disposal stations.
- ▷ Empty waste water tank as often as possible, even when it is not completely full (hygiene).

If possible, flush out waste water tank and, if necessary, drainage pipe with fresh water every time it is emptied.
- ▷ Never allow the toilet cassette or sewage tank to become too full. Empty the toilet cassette or sewage tank frequently, at the latest as soon as the level indicator lights up.
- ▷ Separate household waste according to glass, tin cans, plastic and wet waste also when on a journey. Enquire at the town or community authority about disposal points. Household waste is not to be disposed of in waste paper baskets which are situated at car parks.
- ▷ Empty waste bins as often as possible into the containers provided for this purpose. This helps to avoid unpleasant smells and an accumulation of rubbish on board.



- ▷ When parked, do not allow the engine to run more than necessary. When running idle, a cold engine releases more contaminants than usual. The running temperature of the engine is achieved more quickly whilst the vehicle is in motion.
- ▷ Use an environmentally-friendly WC chemical agent for the WC which can also be biologically degraded and only use small doses.
- ▷ When staying in towns and communities for long periods, search for parking areas which are specially reserved for motorhomes. Enquire at the town or community authority about parking spaces.
- ▷ Always leave the parking places in a clean condition.

2.1 Bürstner Warranty Conditions



1. BÜRSTNER GmbH & Co. KG, Weststraße 33, 77694 Kehl (Guarantor) grants a 10-year water ingress warranty on vehicles manufactured from model year 2019 onwards, up to a maximum mileage of 120,000 km and that the following components of the caravan or motorhome are sealed in such a way that there is no ingress of moisture from the outside to the inside (interior) during normal, contractual and non-commercial use of the vehicle.

Exterior connecting seams:

- Roof/side wall
- Roof/rear wall
- Roof/driver's cabin
- Walls/underbody
- Chassis/underbody

Outer seal seams between built-in parts and the cut-outs of the body:

- Doors
- Windows
- Service and garage flaps
- Skylights
- Water filling devices
- Power supply flaps

The party covered by the warranty is responsible for proving that the vehicle is covered by the warranty.

2. In the event of proof of a warranty claim due to faulty sealing (cf. Point 1.), the guarantor is exclusively obliged under these warranty conditions to repair the affected vehicle parts free of charge or to replace the affected parts, depending on what the guarantor considers necessary to remedy the water ingress. The required work shall be carried out by the guarantor or by an authorised workshop in accordance with the guarantor's guidelines. Should additional costs arise while remedying the water ingress due to installations or other changes to the vehicle compared to the original condition, these shall be borne by the guarantor. The cost of warranty work carried out by neither the guarantor nor one of the guarantor's authorised workshops is non-refundable, irrespective of the existence of a warranty claim. The party covered by the warranty shall not be entitled to other claims under this warranty, in particular regarding subsequent delivery, withdrawal from the purchase contract, price reduction or compensation for damages (including consequential damages), as well as compensation for direct or indirect, material or immaterial consequential damages. Excluded are e.g. claims for compensation for transport or travel costs, towing costs, loss of earnings or holiday cancellation, as well as compensation for futile expenditure. The legal rights of the party covered by the warranty with regards to its seller remain unaffected by this warranty. The legal rights of the party covered by the warranty with regards to its seller remain independent of claims under this warranty.

3. Depending on which occurs earlier, the warranty period begins either on the date of first registration or on the handover of the vehicle to the original purchaser, but no later than one year after the first delivery of the vehicle to the dealer.
It applies for the duration of the vehicle's usability, but no longer than 10 years or up to a maximum mileage of 120,000 km, whichever occurs earlier. Change of ownership of the vehicle does not affect the warranty. The warranty shall expire if the yearly inspections required in accordance with Point 4. are not carried out. The performance of warranty work does not extend the warranty period, nor does it result in the period starting anew.
4. The successful assertion of a warranty claim is dependent on the vehicle undergoing a yearly water ingress test at a BÜRSTNER authorised workshop. This inspection shall be carried out each year within the 11th to 13th month after the beginning of the warranty period (cf. Point 3.). The costs of carrying out the water ingress test shall be borne by the party covered by the warranty. Claims under this warranty by the party covered by the warranty are only valid if the performance of the yearly inspections has been properly verified by a BÜRSTNER authorised workshop.
This includes an inspection record filled out by the BÜRSTNER authorised dealer. Proof of the regular performance of water ingress tests shall be provided by the party covered by the warranty.
5. The occurrence of water ingress, or moisture indicative of water ingress, shall be reported by the party covered by the warranty to a BÜRSTNER authorised workshop, in writing, within 15 days of becoming aware of the issue. Knowledge is equivalent to grossly negligent and negligent ignorance. Compliance with the 15-day deadline is dependent on receipt of the notification at a BÜRSTNER authorised workshop. The notification shall be attached to the warranty document. If the water ingress is not reported correctly and in due time, no claims under this warranty are possible.
6. The necessity, method and scope of remedying the water ingress is at the sole discretion of the guarantor or its authorised workshops.
7. Warranty claims are excluded in the event of:
 - Forces of nature (e.g. floods, hail, etc.) and animal damage of any kind.
 - Damage resulting from an accident.
 - Water ingress due to conversions or additions to the vehicle that were not carried out by a BÜRSTNER authorised workshop.
 - Water ingress due to improper damage repairs that were not carried out by a BÜRSTNER authorised workshop.
 - Damage to the outer shell discovered during inspections that was not repaired immediately by the party covered by the warranty.
 - Aluminium corrosion that cannot be attributed to water ingress.
 - If the vehicle is modified using spare parts that have not been authorised by BÜRSTNER, and a warranty claim arises as a result.

- Condensation due to insufficient ventilation.
 - Improper, non-contractual handling and use of the vehicle.
 - Damage due to incorrect use of care products or cleaning agents (see “Care” instructions in the instruction manual).
 - Damage due to non-compliance with the instruction manual or the manufacturer’s repair and maintenance instructions.
 - All other damages that are not the responsibility of the guarantor or an authorised workshop of the guarantor.
8. Water ingress tests are subject to a fee. The costs of the inspections shall be paid by the party covered by the warranty (cf. Point 4).
9. As far as legally permissible, the exclusive place of jurisdiction shall be Kehl, Germany. The place of performance for all claims under this Warranty is Kehl. This warranty is governed exclusively by the law of the Federal Republic of Germany. This applies regardless of the place of residence or business of the party covered by the warranty.

2.2 Proof of water ingress tests

Providing proof



- ▷ The annual water ingress tests are a prerequisite for the weatherproof guarantee of the housing body.

It is mandatory that the inspection record is filled in completely, entered in the online system, and printed out for you after each carried out test by your dealer.

2.2.1 Vehicle data

The following inspection records apply exclusively to the vehicle:

Datum	Entry
Model, type	
Chassis number	
Key no.	
First registration / date of handover	
Purchased from company	

2.2.2 Water ingress test (certificates)

12 months _____	
Stamp of the Bürstner dealer	
Date	Signature

24 months _____	
Stamp of the Bürstner dealer	
Date	Signature

36 months _____	
Stamp of the Bürstner dealer	
Date	Signature

48 months _____	
Stamp of the Bürstner dealer	
Date	Signature

60 months _____	
Stamp of the Bürstner dealer	
Date	Signature

72 months _____	
Stamp of the Bürstner dealer	
Date	Signature

84 months _____	
Stamp of the Bürstner dealer	
Date	Signature

96 months _____	
Stamp of the Bürstner dealer	
Date	Signature

108 months _____	
Stamp of the Bürstner dealer	
Date	Signature

Date: August 2018

Chapter overview

This chapter contains important safety instructions. The safety instructions are for the protection of persons and property.

3.1 Fire prevention

3.1.1 Avoidance of fire risks



- ▶ Never leave children in the vehicle unattended.
- ▶ Keep flammable materials clear of heating and cooking appliances.
- ▶ Halogen lamps can get very hot. When the light is switched on, there must always be a safety distance of 30 cm between light and flammable objects. Fire hazard!
- ▶ Never use portable heating or cooking appliances.
- ▶ Only authorised qualified personnel may make changes to the electrical system, gas system or appliances.

3.1.2 Fire-fighting



- ▶ Always carry a dry powder fire extinguisher in the vehicle. The fire extinguisher must be approved, tested and close at hand.
- ▶ Have the fire extinguisher tested at regular intervals by authorised qualified personnel. Observe the date of testing.
- ▶ Depending on the equipment, the fire extinguisher is included in the scope of delivery.
- ▶ Always keep a fire blanket near the cooker.

3.1.3 In case of fire



- ▶ Evacuate all passengers.
- ▶ Cut off the electrical power supply and disconnect from the mains.
- ▶ Close regulator tap on the gas bottle.
- ▶ Sound the alarm and call the fire brigade.
- ▶ Fight the fire if this is possible without risk.



- ▷ Acquaint yourself with the position and operation of the emergency exits.
- ▷ Keep escape routes clear.
- ▷ Observe the fire extinguisher instructions for use.

3.2 General



- ▶ The oxygen in the vehicle interior is used up by breathing and the use of gas operated appliances. That is why the used air must be replaced permanently. For this purpose, forced ventilation systems (e.g. skylights with forced ventilation, mushroom-shaped vents or floor vents) are installed in the vehicle. Never cover or block forced ventilations from the inside or outside with objects such as e.g. a winter mat. Keep forced ventilations clear of snow and leaves. There is a danger of suffocation due to increased CO₂ levels.
- ▶ Do not use storage spaces or rear garages as places for people or animals to stay or sleep in. These spaces are not forced-air ventilated. There is a danger of suffocation due to oxygen deprivation or exhaust from the heater.
- ▶ Observe the headroom of the doors.



- ▷ As far as the fitted appliances (heater, cooker, refrigerator, etc.) and the base vehicle (engine, brakes, etc.) are concerned, the instruction manuals are authoritative. It is imperative that they be observed.
- ▷ Fitting accessories or special equipment can alter the dimensions, weight and road behaviour of the vehicle. Some of the parts must be entered in the vehicle papers.
- ▷ Only use wheel rims and tyres which are approved for the vehicle. Information concerning the size of the approved wheel rims and tyres is included in the vehicle documents or can be obtained from authorised dealers and service centres.
- ▷ Firmly apply the handbrake when parking the vehicle.
- ▷ If the maximum permissible gross weight of the vehicle exceeds 4 tonnes, wheel chocks must be used when parking on gradients. The wheel chocks are provided as standard for vehicles with a maximum permissible gross weight exceeding 4 tonnes.



- ▷ When leaving the vehicle, it is imperative that all doors, external flaps and windows are closed.
- ▷ Always carry the legally prescribed equipment (e.g. first aid kit, warning vest, hazard warning triangle etc.) with you. The regulations of the host country apply when travelling abroad.
- ▷ The vehicle may only be driven by drivers who hold a driving licence which is valid for the respective vehicle class.
- ▷ When selling the vehicle, hand over all instruction manuals for the vehicle and the fitted appliances.

3.3 Road safety



- ▶ Before commencing the journey, carry out a functional check of indicating and lighting equipment, the steering and the brakes.
- ▶ If the vehicle has been stationary for a long period (approx. 10 months) have the braking and gas systems checked by an authorised specialist workshop.
- ▶ Before commencing the journey and after short interruptions of the journey, ensure that the entrance step is completely retracted.



- ▶ Before commencing the journey, open and secure the shades on the windscreen and on the driver's and front passenger's windows.
- ▶ Before commencing the journey, place and secure the flat screen and screen support in the initial position. If the screen holder is installed in a TV cabinet: Close TV cabinet.
- ▶ Before commencing the journey, remove the loose sink cover (if present) and store it securely in the kitchen unit or wardrobe.
- ▶ Carefully store all moving parts and all loose objects before starting your journey.
- ▶ Before commencing the journey, fix adjustable tables.
- ▶ Before commencing the journey, rotate all swivel seats in the direction of travel and lock in position. During the journey, the swivel seats must remain locked in place in the direction of travel.
- ▶ It is not permitted to stay in the alcove during the journey.
- ▶ During the journey, persons are only to sit on the permitted seats (see chapter 5). The authorised number of seats is stipulated in the vehicle documents.
- ▶ Seat belts must be worn by all passengers.
- ▶ Fasten your seat belts before the beginning of the journey and keep them fastened during the journey.
- ▶ When travelling, secure children under 13 years of age that are smaller than 150 cm, with a suitable and officially approved child restraint system.
- ▶ Only attach the child restraint system to seats that are specified for this purpose. We strongly recommend to install child restraint systems preferably in the second row of seats.
- ▶ **Never** use rearward-facing child restraints on a seat with **activated front airbag**. This may lead to **death** or to **serious injuries** in children.
- ▶ The base vehicle is a commercial vehicle (small truck). Adjust your driving technique accordingly.
- ▶ In case of underpasses, tunnels or similar obstacles, note the total height of the vehicle (including the roof load).
- ▶ In winter, the roof must be free of snow and ice before commencing the journey.
- ▶ Check tyre pressure before a journey or every 2 weeks. Wrong tyre pressure causes excessive wear and can lead to damage or even to tyre burst. You can lose control of the vehicle (see section 14.7).
- ▶ Do not operate the heater at petrol stations. Danger of explosion!
- ▶ Do not operate the heater in closed spaces. Danger of suffocation!



- ▷ Before commencing the journey, distribute the payload evenly within the vehicle (see chapter 4).
- ▷ When loading the vehicle and when taking a rest from driving, in order to load luggage or food, for example, observe the maximum permissible gross weight and axle loads (refer to vehicle documents).
- ▷ Before commencing the journey, close and lock, if possible, all inner doors, adjustable partition walls, drawers and flaps. Engage the refrigerator door securing device.



- ▷ Before commencing the journey, close windows and skylights.
- ▷ Before commencing the journey, close all external flaps and lock them.
- ▷ Before commencing the journey, remove the external supports and retract the corner steadies or steady legs, which are fitted to the vehicle.
- ▷ Before commencing the journey, put the antenna in park position.
- ▷ During the initial journey and each time after changing a wheel, re-tighten the wheel bolts/wheel nuts after 50 km (30 miles). Subsequently inspect them at regular intervals in order to ensure that they are firmly seated. See chapter 14 for tightening torque.
- ▷ Tyres should not be older than 6 years as the material becomes brittle over time (see chapter 14).
- ▷ When using snow chains, the tyres, wheel suspension and steering are subjected to an additional load. When using snow chains, drive slowly (maximum speed 50 km/h) and only on streets which are completely covered with snow. Otherwise the vehicle could be damaged.

3.4 Towing



- ▶ Care is to be taken when connecting and detaching a trailer. Risk of accident and injury!
- ▶ No persons are to be between the towing vehicle and the trailer during positioning for connecting and detaching.

3.5 Gas system

3.5.1 General instructions



- ▶ The operator of the gas system is responsible for the performance of recurring inspections and for complying with the maintenance intervals.
- ▶ Before commencing the journey, when leaving the vehicle or when gas equipment is not in use, close all gas isolator taps and the main isolator tap on the gas bottle.
- ▶ All gas-operated devices (heater, cooker, oven, grill, refrigerator - depending on the equipment) must be switched off for refuelling, on ferries or in the garage. Danger of explosion!
- ▶ Do not use gas-operated devices in closed spaces (e.g. garages). Danger of poisoning and suffocation!
- ▶ Only have the gas system maintained, repaired or altered by an authorised specialist workshop.
- ▶ Have the gas system checked by an authorised specialist workshop according to the national regulations before commissioning. This also applies for not registered vehicles. For modifications to the gas system have the gas system immediately checked by an authorised specialist workshop.
- ▶ The gas pressure regulator, the gas tubes, and the exhaust gas pipes must also be inspected. The gas pressure regulator and the gas tubes must be replaced observing the nationally defined deadlines (the latest after 10 years). The vehicle owner is responsible for seeing that this is carried out.



- ▶ In case of a defect of the gas system (gas odour, high gas consumption) there is danger of explosion! Close regulator tap on the gas bottle immediately. Open doors and windows and ventilate well.
- ▶ If the gas system is defective: Do not smoke; do not ignite any open flames, and do not operate electric switches (light switches etc.). Check the tightness of gas-conducting parts and lines with leakage search spray. Do not check with an open flame.
- ▶ Only the stipulated devices may be connected to internal connections. Do not operate any device outside the vehicle if it is connected to an internal connector.
- ▶ Cooking is prohibited during the journey.
- ▶ Before using the cooker make sure that there is sufficient ventilation. Open a window or the skylight.
- ▶ Do not use gas-operated cooking and baking facilities for heating purposes.
- ▶ If there are several gas devices, each gas device must have its own gas isolator tap. If individual gas devices are not in use, close the respective gas isolator tap.
- ▶ Ignition safety valves must close within 1 minute after the gas flame has extinguished. A clicking sound is audible. Check function from time to time.
- ▶ The built-in gas devices are exclusively meant for use with propane or butane gas or a mixture of both. The gas pressure regulator as well as all built-in gas devices are designed for a gas pressure of 30 mbar.
- ▶ Propane gas is capable of gasification up to $-42\text{ }^{\circ}\text{C}$, whereas butane gas gasifies at $0\text{ }^{\circ}\text{C}$. Below these temperatures no gas pressure is available. Butane gas is unsuitable for use in winter.
- ▶ Due to its function and construction, the gas bottle compartment is a space which is open to the exterior. Never cover or block up the standard forced ventilations. Otherwise gas that is emitted can not be diverted to the outside.
- ▶ The gas bottle compartment must not be used as storage space.
- ▶ Secure the gas bottle compartment against unauthorised access. To do this, lock the compartment.
- ▶ The regulator tap on the gas bottle must be accessible.
- ▶ Only connect gas-operated devices (e.g. gas grill) which have been designed for a gas pressure of 30 mbar.
- ▶ The exhaust gas pipe must be fitted tightly to the heating system and to the vent and must be sealed. The exhaust gas pipe must not show any evidence of damage.
- ▶ Exhaust fumes must be able to escape into the atmosphere unhindered and fresh air must be able to enter unhindered. For this reason, keep the exhaust pipe and intake openings clean and unobstructed (e.g. free from snow and ice). For this reason, no snow walls or aprons may lie against the vehicle.

3.5.2 Gas bottles



- ▶ Handle full or emptied gas bottles outside the vehicle only with closed regulator tap and attached protective cap.
- ▶ Gas bottles are only to be transported within the designated gas bottle compartment.
- ▶ Place the gas bottles in vertical position in the gas bottle compartment.
- ▶ Fasten the gas bottles so that they are unable to turn or tilt.
- ▶ Connect the gas tube to the gas bottle without tension.
- ▶ If the gas bottles are not connected to the gas tube, always place the protective cap on top.
- ▶ Close the regulator tap on the gas bottle before the gas pressure regulator or gas tube are removed from the gas bottle.
- ▶ Depending on the connection, unscrew the gas tube from the gas bottle and screw it on the gas bottle again by hand or using a suitable special spanner. The screw connection on the gas bottle generally has a left-hand thread. **Do not** tighten too firmly.
- ▶ Only use special gas pressure regulators with a safety valve designed for vehicle use. Other gas pressure regulators are not permitted and cannot meet the demanding requirements.
- ▶ Use the gas pressure regulator defroster if the temperature falls below 5 °C.
- ▶ Use only 11 kg or 5 kg gas bottles. Camping gas bottles with built-in check valve (blue bottle with max. 2.5 or 3 kg content) are can be used in exceptional cases with a safety valve.
- ▶ Use the shortest possible tube lengths (150 cm max.) for external gas bottles.
- ▶ Never block the floor ventilation openings below the gas bottles.

3.6 Electrical system



- ▶ Only allow qualified personnel to work on the electrical system.
- ▶ Prior to carrying out work on the electrical system, switch off all devices and lights, disconnect the battery and disconnect the vehicle from the mains.
- ▶ Only use original fuses with the stipulated values.
- ▶ Only replace defective fuses when the cause of the defect is known and has been remedied.
- ▶ Never bridge or repair fuses.

3.7 Water system



- ▶ Water left standing in the water tank or in the water pipes becomes undrinkable after a short period. Therefore, before each use of the vehicle, thoroughly clean the water pipes and the water tank. After each use of the vehicle completely empty the water tank and the water pipes.
- ▶ In the case of lay-ups lasting more than a week disinfect the water system before using the vehicle (see chapter 12).



- ▷ If the vehicle is not used for several days or if it is not heated when there is a risk of frost, empty the entire water system. Make certain that the water pump is switched off on the panel. Otherwise, the water pump will overheat and may get damaged. Leave the water taps on in central position. Leave the safety/drainage valve (if there is one) and all drain cocks open. Frost damage to appliances, frost damage to the vehicle and deposits in water-carrying components can be avoided in this way.

Chapter overview

This chapter contains important information which has to be noted before commencing your journey or carrying out any tasks before the journey.

At the end of the chapter there is a checklist which once again summarises the most important points.

4.1 Keys

The following keys are included with your vehicle:

Two keys for

- ignition lock
- driver's and passenger's doors
- fuel tank

Two keys for

- conversion door of the body
- drinking water filler neck
- external flaps

Always deposit a replacement key outside the vehicle. Make a note of the key number. Our authorised dealers and workshops can offer assistance in case of loss.

4.2 Registration

Your vehicle is a motor vehicle subject to registration. Observe national regulations on registration.

Please remember that certain countries require a separate national code sticker in addition to the EU plate.

4.3 Payload



- ▶ Overloading the vehicle and wrong tyre pressure can cause tyres to burst. You can lose control of the vehicle (see section 14.7).
- ▶ The maximum permissible gross weight and the weight including special equipment fitted at the factory (actual weight) is shown in the vehicle documents, but not the weight of the loaded vehicle (see section 4.3.1). For your own safety, we recommend that you have your loaded vehicle (with all passengers, luggage and personal objects) weighed on a public weighbridge before you set out on your journey.
- ▶ Adapt the speed to the payload. The stopping distance is increased if the payload is high.



- ▷ Do not exceed the maximum permissible gross weight (permissible total weight) stated in the vehicle documents and the maximum axle loads as a result of the payload.
- ▷ Built-in accessories and special equipment reduce the payload.
- ▷ Adhere to the axle load stated in the vehicle documents.

On loading, make sure that the payload's centre of gravity is as low as possible (directly above the floor of the vehicle). Otherwise this may affect the driving characteristics of the vehicle.

Maximum permitted payloads

Description	Load (kg)
Overcab bed	200
Roof load	200
Rear garage and rear storage space	200
Bike rack	Double 60
	Triple 60
E-bike bike rack	100
Load rack (AL-KO)	150

4.3.1 Terms



▷ Technically speaking, the term "mass" has now replaced the term "weight". However, "weight" is still the term more frequent in common use. For better understanding, "mass" is therefore only used in the following sections for fixed formulations.

Maximum permissible gross weight in a laden condition

The maximum permissible gross weight in a laden condition is the weight that a vehicle may never exceed.

The maximum permissible gross weight in a laden condition consists of the **actual weight** and the **payload**.

In the vehicle documents, the manufacturer has specified the maximum permissible gross weight in a laden condition.

Actual weight

The actual weight consists of the mass in ready-to-drive condition and the weight of the special equipment fitted at the factory.

Mass in ready-to-drive condition

The mass in ready-to-drive condition is the weight of the ready-to-drive standard vehicle (excluding special equipment fitted at the factory).

The mass in ready-to-drive condition is made up as follows:

- Unladen weight (mass of the empty vehicle) with factory-installed standard equipment (excluding special equipment fitted at the factory)
- Driver's weight
- Basic equipment weight

Unladen weight includes lubricants such as oils and coolants which have been filled, the on-board tool set and a fuel tank which has been filled up to 90 %.

75 kg are calculated for the weight of the driver, regardless of how much the driver really weighs.

Basic equipment includes all equipment and fluids required for safe and proper vehicle use. The weight of the basic equipment includes:

- A full fresh water system
- A gas bottle filled up to 90 %
- A full heating system
- The power cables for the 230 V power supply

- A full toilet flushing system
- The installation kit for an auxiliary battery if an auxiliary battery can be used

The waste water and sewage tanks are empty.

Example for calculating the basic equipment

Water tank in the ready-to-drive state with 100 l (overflow open)	100 kg
Aluminium gas bottle	+ 11.5 kg
Boiler with 20 l	+ 20 kg
230 V power cable	+ 4 kg
Total	= 135.5 kg

The mass in ready-to-drive condition and the actual weight are shown in the vehicle documents (e.g. 2900/2950 kg).

Payload

The payload is made up as follows:

- Conventional load
- Additional equipment
- Personal equipment



▷ The vehicle's payload can be increased by reducing the actual weight. To do this, it is allowed for example to empty the fluid containers or to remove the gas bottles.

You will find explanations on the individual components of the payload in the following text.

Conventional load

The conventional load is the weight specified by the manufacturer for the passengers.

Conventional load means: 75 kg are calculated for every seat specified by the manufacturer, regardless of how much the passengers actually weigh. The driver's seat is already included as part of the mass in ready-to-drive condition and must **not** be calculated as part of the conventional load.

In the vehicle documents, the manufacturer specifies the number of seats.

Additional equipment

Additional equipment includes accessories and special equipment. Examples of additional equipment include:

- Caravan coupling
- Awning
- Bike or motorcycle rack
- Satellite unit
- Microwave oven

Chapter 16 lists the weights of the various items of special equipment; they may also be obtained from the manufacturer.

Personal equipment

Personal equipment includes all items in the vehicle that are not included in the conventional load or in the additional equipment. For example, personal equipment can include the following:

- Foodstuffs
- Crockery
- Television

- Radio
- Clothes
- Bedding
- Toys
- Books
- Toiletries

No matter where kept, personal equipment also includes:

- Animals
- Bikes
- Boats
- Surfboards
- Sports equipment

For the personal equipment, according to the applicable regulations, the manufacturer must use a minimum weight that is determined according to the following formula:

Formula Minimum weight M (kg) = 10 x N + 10 x L

Explanation N = maximum number of people including the driver, as stated by the manufacturer
L = total length of the vehicle in metres

4.3.2 Calculating the payload



- ▶ The payload calculation at the factory is partly based on all-inclusive weights. For safety reasons, the maximum permissible gross weight in a laden condition must not be exceeded.
- ▶ The maximum permissible gross weight and the weight including special equipment fitted at the factory (actual weight) is shown in the vehicle documents, but not the weight of the loaded vehicle (see section 4.3.1). For your own safety, we recommend that you have your loaded vehicle (with all passengers, luggage and personal objects) weighed on a public weighbridge before you set out on your journey.

The payload (see section 4.3.1) is the difference in weight between

- the maximum permissible gross weight in a laden condition and
- the actual weight.

Example for calculating the payload

	Mass in kg to be calculated	Calculation
Maximum permissible gross weight according to vehicle documents	5000	
Actual weight including basic equipment according to vehicle documents	- 4300	
This results in a permissible payload of	700	

The calculation of the payload from the difference between the maximum permissible gross weight in laden condition and the actual weight specified by the manufacturer is however only a theoretical value.

Only if the vehicle is weighed with full tanks (fuel and water), full gas bottles and complete additional equipment on a public weighbridge, can the actual payload be determined.

To do this, proceed as follows:

- First only drive the vehicle on to the weighbridge with the front wheels and have it weighed.
- Then drive the vehicle on to the weighbridge with the back wheels and have it weighed.

The individual values give the current axle loads. These are important for the correct loading of the vehicle (see section 4.3.3). The sum of these values is the current weight of the vehicle.

The actual payload is the difference between the maximum permissible gross weight in laden condition and the weighed vehicle weight.

This can be used to determine the weight that remains for the personal equipment:

- Determine the weight of the passengers and subtract it from the value for the actual payload.

The result is the weight that is permitted for the actual load of the personal equipment.

4.3.3 Loading the vehicle correctly



- ▶ For safety reasons, never exceed the maximum permissible gross weight in a laden condition.
- ▶ Distribute the load evenly on the left and right sides of the vehicle.
- ▶ Distribute the load evenly on both axles. In doing so, observe the axle loads specified in the vehicle documents. Observe the permissible load-carrying capacity of the tyres (see chapter 14).
- ▶ Heavy loads behind the rear axle can reduce the load on the front axle due to the leverage effect () . This applies especially to long rear extensions, if a motorbike is transported on the rear carrier or if there is a heavy load in the rear storage space. The release of the front axle negatively affects the driving quality, especially for front-driven vehicles.
- ▶ Store all objects in such a way that they cannot slip.
- ▶ Store heavy objects (awning, tin cans, etc.) close to the axles. Low-lying storage spaces whose doors do not open in the direction of travel are particularly suited for storing heavy objects.
- ▶ Stack light objects (laundry) in the roof storage cabinets.
- ▶ Load the bike rack with bicycles only (max. three units).

Large storage spaces, such as the rear garage, also have room for heavy objects (e.g. motorcycle). This might mean that the axle load on the rear axle is exceeded.

However, the individual axles may not be overloaded under any circumstances. That is why it is important, at which distance to the axles the load is stored.

To distribute the load correctly, you will need a scale, a tape measure, a calculator and some time.

Two simple formulas are needed to calculate the effect of the weight of the load on the axles:

Formulas $A \times G : R = \text{weight on the rear axle}$

Weight on the rear axle – G = weight on the front axle

Explanation A = distance between storage space and front axle in cm
G = weight of the load in the storage space in kg
R = wheelbase of the vehicle (distance between axles) in cm



▷ Measure the external distances horizontally from the centre of the front wheel to the centre of the storage space or to the centre of the back wheel.

Calculating axle loads:

- Multiply the distance between storage space and front axle (A) with the weight of the load in the storage space (G) and divide the result by the wheelbase (R). The result is the weight of the load in the storage space on the rear axle. Make a note of this weight and of the storage space.
- In a second step, subtract the weight in the storage space (G) from the weight calculated beforehand. If the result is a **positive** value (example 1), this means that the load on the front axle is **reduced** by this value. If the result is a **negative** value (example 2), this means that the load on the front axle is **increased**. Make a note of this value, too.
- Calculate all storage spaces of the vehicle in the same way.
- In a last step, add all weights calculated for the rear axle to the rear axle load and add (or subtract) all weights calculated for the front axle to (from) the front axle load.
How to determine rear axle load and front axle load is described in section 4.3.2.

If the calculated value exceeds the permissible axle load, the load must be distributed in a different way.

If the load on the front axle is too low, the grip of the tyres on the road is reduced (traction), as is the vehicle's steerability. This applies in particular to vehicles with front-wheel drive. In this case, the load must be redistributed, too.

Example calculation

		Example 1	Example 2
Distance to the front axle	A	(A1) 450 (cm)	(A2) 250 (cm)
Weight in the storage space	G	× 100 (kg)	× 50 (kg)
Wheelbase of the vehicle	R	÷ 325 (cm)	÷ 325 (cm)
Load on the rear axle (add to the axle load)		138.5 (kg)	38.5 (kg)
Weight in the storage space		- 100 (kg)	- 50 (kg)
Load relief to the front axle (subtract from the axle load)		38.5 (kg)	
Load on the front axle (add to the axle load)			-11.5 (kg)

4.3.4 Rear garage/rear storage space



- ▶ Do not use storage spaces or rear garages as places for people or animals to stay or sleep in. These spaces are not forced-air ventilated. There is a danger of suffocation due to oxygen deprivation or exhaust from the heater.
- ▶ Observe the permissible axle loads and maximum permissible gross weight when loading the rear garage/the rear storage space.
- ▶ The maximum permitted load of the rear garage/the rear storage space is 200 kg. Do not exceed the permissible rear axle load.
- ▶ Observe: If the rear garage or (depending on the model) the rear storage space is **loaded** to its maximum capacity, this will **reduce the load** on the front axle due to the levering action. The driving quality is impaired.



- ▷ Depending on the vehicle equipment, clamping rails with clamping eyelets are mounted in the rear garage or in the rear storage space. Always secure loads onto the clamping eyelets. Always use tightening straps or lashing nets for securing the load, never rubber expanders.
- ▷ When clamping loads, always check that the clamping eyelets are placed tightly in the clamping rails. If the clamping eyelet is not anchored tightly in the clamping rail, the load may slide or loosen during forcible movements of the steering wheel or when braking.
- ▷ Distribute the load evenly. Excessive spot loads can lead to damages of the floor covering.
- ▷ If there is a pull-out present in the rear storage space: make sure that the pull-out is engaged.
- ▷ Use the supporting system offered by your dealer if two-wheelers are transported in the rear garage.

4.3.5 Double floor



- ▶ Observe the permissible axle loads and maximum permissible gross weight when loading the double floor.



- ▷ Distribute the load evenly. Excessive spot loads can lead to damages of the floor covering.

4.3.6 Bike rack (special equipment)



- ▶ Observe the permissible axle loads and maximum permissible gross weight when loading the bike rack.
- ▶ A total width of 2.55 m must not be exceeded. Adjust the attachments for the bikes accordingly. The overhang to the side and rear must be marked in accordance with the regulations for the country in which you are travelling.
- ▶ Load the bike rack with bicycles only (max. three units).
- ▶ Fasten bicycles using the straps provided and check to see that they are secure after you have driven a few kilometres.
- ▶ Check the secure attachment of the bicycles on the bike rack after the first 10 km and then at each break in the journey.
- ▶ Do not use the bike rack as luggage rack or ladder.



- ▷ The bike rack is only to be used for transporting bicycles.
- ▷ The gross weight specified by the manufacturer must not be exceeded.
- ▷ The identification plate and rear lights must not be covered.
- ▷ The maximum permissible payload of the bike rack is 60 kg.
- ▷ When loading the bike rack, observe the centre of gravity. If the bike rack is only loaded with **one** bicycle, position the bicycle as closely as possible to the vehicle wall.
- ▷ Driving with a folded out bike rack without bicycles is not permitted.
- ▷ Before every journey, check:
 - Is the bike rack without bicycles folded in correctly?
 - Are the bicycles securely fastened to the bike rack using the bike rack belts?

Loading the bike rack with bicycles

When loading the bike rack, observe the centre of gravity. The centre of gravity of the bicycles must be as close as possible to the rear wall of the vehicle. The bike rack should always be loaded from the inside to the outside.

Loading the bike rack correctly:

- Depending on the model, fold the bike rack down or pull it out.
- Place the heaviest bicycle directly against the rear wall.
- Place the lightest bicycles in the centre or on the outside of the bike rack.
- Secure the front and rear wheels of each bicycle with the retaining straps on the bike rack.
- In addition, fasten the outermost bicycle depending on the model of the bike rack on the retaining clip or the retaining bracket and to the spacer respectively.

If the bike rack is only loaded with **one** bicycle, position the bicycle as closely as possible to the rear wall.

Bike rack, not lowerable

▷ Also read the manufacturer's instruction manual.



Fig. 1 Bike rack, not lowerable

Depending on the model, the bike rack can be used to transport 2 or 3 bicycles comfortably.

Loading the bicycles:

- Fold the swivel clip down.
- Place the bicycles on top and secure them with quick straps.
- Fasten the spacer to the frame of the outermost bicycle.

Bike rack, lowerable

▷ Also read the manufacturer's instruction manual.

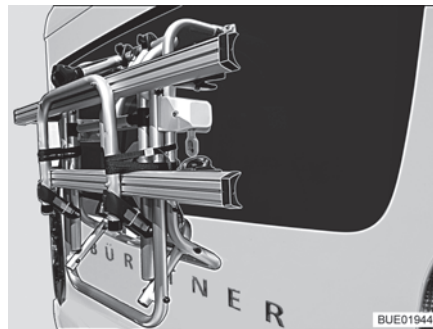

Fig. 2 Bike rack, folded upwards

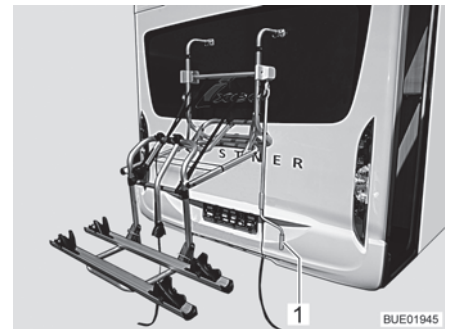

Fig. 3 Bike rack, lowered

The bike rack (Fig. 2) permits to easily transport 2 bicycles. Expansion for 3 bicycles is possible. A winding system can be used to lift and lower the bike rack. The winding system brings the bicycles to gripping height within seconds.

Loading the bicycles:

- Attach the hand crank (Fig. 3,1) to the bike rack and lower the bike rack to gripping height.
- Place the bicycles on top and secure them with quick straps.
- Fasten the bike-block spacer to the frame of the outermost bicycle.
- Use the hand crank to raise the bike rack again.

4.3.7 Bike/e-bike bike rack (special equipment)



- ▶ Observe the permissible axle loads and maximum permissible gross weight when loading the bike rack.
- ▶ A total width of 2.55 m must not be exceeded. Adjust the attachments for the bikes accordingly. The overhang to the side and rear must be marked in accordance with the regulations for the country in which you are travelling.
- ▶ Lock bike rack in drive position before starting your journey.
- ▶ Fasten bicycles using the straps provided and check to see that they are secure after you have driven a few kilometres.
- ▶ Check the secure attachment of the bicycles on the bike rack after the first 10 km and then at each break in the journey.
- ▶ Do not use the bike rack as luggage rack or ladder.



- ▷ The bike rack is designed only to carry bicycles and electrically assisted bicycles (e-bikes, pedelecs).
- ▷ The gross weight specified by the manufacturer must not be exceeded.
- ▷ The identification plate and rear lights must not be covered.
- ▷ The maximum permitted payload of the bike rack is 80 kg.
- ▷ When loading the bike rack, observe the centre of gravity. If the bike rack is only loaded with **one** bicycle, position the bicycle as closely as possible to the vehicle wall.
- ▷ Before fixing bicycles, check that the retaining arms and the wheel-holders of the bike rack are in the correct position. If necessary, adjust the retaining arm or wheel-holder to fit the bicycle.
- ▷ Driving with a folded out bike rack without bicycles is not permitted.
- ▷ Before every journey, check:
 - Is the bike rack without bicycles folded in correctly?
 - Are the bicycles securely fastened to the bike rack using the bike rack belts?
- ▷ If the bicycle rack is equipped with a charging unit:
 - Are the charging cables securely fastened? Otherwise, charging cables can tear off.

Loading the bike rack with bicycles

When loading the bike rack, observe the centre of gravity. The centre of gravity of the bicycles must be as close as possible to the rear wall of the vehicle. The bike rack should always be loaded from the inside to the outside.

Loading the bike rack correctly:

- Place the heaviest bicycle directly against the rear wall.
- Position the lighter bicycle on the outside of the bike rack.
- Secure the front and rear wheels of each bicycle with the retaining straps on the bike rack.
- Fix every bicycle to the retaining arm.

If the bike rack is only loaded with **one** bicycle, position the bicycle as closely as possible to the rear wall.

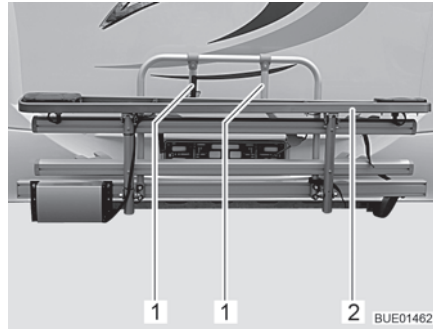

Fig. 4 E-bike bike rack



Fig. 5 Positioning of e-bikes

- Loosen the strap and fold the e-bike bike rack (Fig. 4,2) down.
- Lift the first e-bike onto the bike rack and place it on the wheel-holders (with the front wheel pointing left).
- Swing out the shorter retaining arm (Fig. 4,1) and secure the e-bike's front frame tube (Fig. 5,1) with straps.
- Using the straps, fix both wheels to the wheel-holders.
- Lift the second e-bike onto the bike rack and place it on the wheel-holders (with the front wheel pointing right).
- Swing out the longer retaining arm (Fig. 4,1) and secure the e-bike's front frame tube (Fig. 5,1) with straps.
- Using the straps, fix both wheels to the wheel-holders.
- If necessary, place third e-bike on the wheel-holders and secure it.
- Check that all bicycles are securely fastened.

4.3.8 Removable load rack AL-KO (special equipment)



- ▶ Do not exceed the rear axle load.
- ▶ Heavy loads behind the rear axle can reduce the load on the front axle due to the leverage effect ($\frac{1}{2}$). This applies especially to long rear extensions, if a motorbike is transported on the rear carrier or if there is a heavy load in the rear storage space. The release of the front axle negatively affects the driving quality, especially for front-driven vehicles.
- ▶ Always make sure to store the load roadworthy and secure it against falling.
- ▶ The load may not jut out beyond the maximum width of the vehicle. The lighting and the official licence plate on the load rack may not be covered by the load.
- ▶ Always mount or dismount the load rack with 2 persons.
- ▶ Only mount the unloaded load rack.



- ▶ The load rack and caravan coupling must not be used simultaneously.



- ▶ The load rack has a EG type approval number.
- ▶ Have your dealer or service centre install the load rack.



- ▷ Observe the country-specific regulations.
- ▷ Also read the manufacturer's instruction manual.

The load rack permits transport of a load (e.g. a motorcycle or a motor scooter) weighing up to 150 kg. Always remove the load rack after use.

Installation:

- Apply the handbrake.
- Insert the spars in the holders on the left and right side of the frame and push them in completely.
- Close the clamping levers. To do so, press and rotate the clamping levers.
- Close the clamp fasteners on the support tubes.
- On the left and the right side, put a locking lever through the holes in the holders and in the spars, and secure them with cotter pins.
- Connect the electrics between the load rack and the vehicle.
- Check the fixing of the load rack on the vehicle and the functioning of the lamps.

Removal:

- Apply the handbrake.
- Disconnect the electrics between the load rack and the vehicle.
- On the left and the right side, remove the cotter pin from the locking levers and pull locking levers out off the holders.
- Open the clamp fasteners on the support tubes.
- Open the clamping levers. To do so, press and rotate the clamping levers.
- Remove the spars from the holders on the frame.

Requirement for mounting

If the load rack is to be mounted, two galvanised tube mounts must be attached to the left and right side of the vehicle frame. They are designed to hold the load rack.

4.4 Towing



- ▶ Care is to be taken when connecting and detaching a trailer. Risk of accident and injury!
- ▶ No persons are to be between the towing vehicle and the trailer during positioning for connecting and detaching.
- ▶ Observe the permissible nose weight and rear axle load of the motorhome. Refer to the vehicle documents for the rear axle load.



- ▷ Trailer with an overrun brake: Do not connect or detach trailer with the overrun brake on.
- ▷ Caravan coupling with detachable ball neck: If the ball neck is mounted incorrectly, there is the danger of the trailer breaking away. Observe the instruction manual for the caravan coupling.
- ▷ If the vehicle is equipped with air suspension: The distance between the tow ball of the caravan coupling and the road must be 350 to 420 mm in loaded condition.

The permissible nose weight is 80 kg.

4.5 Caravan coupling (special equipment)



- ▶ When mounting a caravan coupling, see the vehicle documents for information on maximum nose weight and caravan load.
- ▶ Retighten the caravan coupling fixing screws after 1000 operating hours.



- ▷ The load rack and caravan coupling must not be used simultaneously.



- ▷ If the caravan coupling is retrofitted, this must be entered in the vehicle documents. The required documents are enclosed with the caravan coupling.
- ▷ If the caravan coupling was fitted at the factory, this is entered in the vehicle documents. Always keep the appropriate documents in the vehicle.
- ▷ Also read the manufacturer's instruction manual.

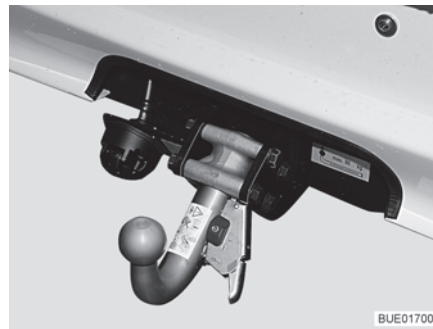

Fig. 6 Caravan coupling, detachable

Entry in the vehicle documents

Have your dealer or service centre install the add-on parts. They will also take care of all the formalities for you.

4.6 Electrically operated entrance step



- ▶ Before commencing the journey and after short interruptions of the journey, ensure that the entrance step is completely retracted.
- ▶ Do not stand in the direct range of the entrance step while it is being retracted or extended.
- ▶ Do not step on the entrance step until it has extended completely. There is a risk of injury.
- ▶ Do not under any circumstances raise or lower persons or loads with the entrance step.



- ▷ Take note of the different step heights and make certain that the ground is firm and even when exiting.
- ▷ Do not grease or lubricate the pivot bearing and joints of the entrance step (see chapter 12).



- ▷ The button to operate the entrance step is located on the inside of the vehicle in the area of the conversion door.
- ▷ If the entrance step has not been retracted correctly, a red indicator lamp lights up on the dashboard when switching on the ignition.
- ▷ Follow the warning notice on the entrance step.

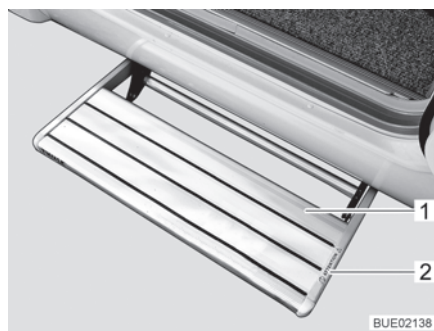

- 1 Entrance step
- 2 "Risk of crushing" warning notice

Fig. 7 Entrance step

The vehicles have a one-step, electrically extendable entrance step (Fig. 7,1).

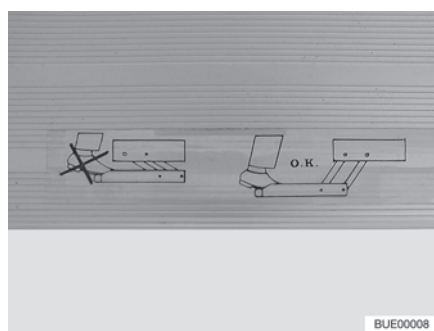

Fig. 8 Warning notice for entrance step

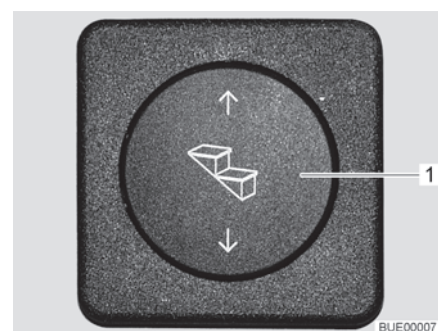

Fig. 9 Operating button for entrance step

Before stepping on the entrance step, fully extend it (Fig. 8).

- Extending:**
- Press the rocker button (Fig. 9,1) down and hold it pressed (at least 3 seconds) until the entrance step has extended completely.

- Retracting:**
- Press the rocker button (Fig. 9,1) up until the entrance step has retracted completely.

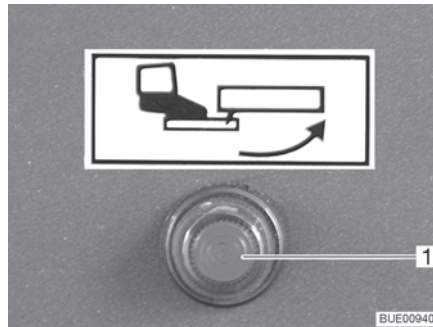

Fig. 10 Indicator lamp

When the ignition is switched on and the entrance step is extended, an indicator lamp (Fig. 10,1) is illuminated on the dashboard.

4.7 TV unit (special equipment)



- ▶ Before commencing the journey, place and secure the flat screen and screen support in the initial position. If the screen holder is installed in a TV cabinet: Close TV cabinet.
- ▶ Before commencing the journey, ensure that the antenna is in park position. Danger of accidents! Park position means: The antenna points towards the back, is fully lowered and is locked in this position.



- ▷ Further information on positioning the flat screen can be obtained from chapter 7.

4.8 Securing add-on parts



- ▶ In the event of an accident or emergency braking, loose add-on parts could injure the occupants of the vehicle. Before setting off, secure loose add-on parts in the holders provided or stow them in a secure place inside the vehicle.



- ▷ Unsecured flaps and doors can spring open during the journey and damage parts of the interior. Secure all flaps and doors before setting off.

Add-on parts Add-on parts include bed extensions, ladders or table extensions.



Fig. 11 Bed extension in the rear garage



Fig. 12 Access ladder in the wardrobe

- Securing add-on parts:**
- Place the add-on parts (Fig. 11,1 and Fig. 12,1) in the holders provided and secure them with the available means of attachment.
 - If no holder is provided for the add-on part, stow the add-on part in a storage space the doors of which cannot be opened in the direction of travel (e.g. wardrobe or rear storage space).

Doors and flaps Doors are, for example, inner doors or partition walls. See section 7.4 for furniture flaps.



Fig. 13 Shower partition

- Securing doors:**
- Secure doors or partition walls (Fig. 13,1) with the locks or means of securing provided.

4.9 Snow chains (special equipment)



- ▷ Only mount snow chains if there is a clearance of at least 50 mm between the tyres and the vehicle body.
- ▷ When using snow chains, the tyres, wheel suspension and steering are subjected to an additional load. When using snow chains, drive slowly (maximum speed 50 km/h) and only on streets which are completely covered with snow. Otherwise the vehicle could be damaged.
- ▷ Observe the fitting instructions issued by the manufacturer of the snow chains.
- ▷ Do not fit snow chains on alloy wheel rims.

Only use suitable snow chains:

Tyre size	Snow chain size
215/70 R 15 C	230
225/75 R 16 C	245

The use of snow chains is subject to the legal regulations of the individual countries.

- Always mount snow chains to the drive wheels.
- After a few metres, check the tension of the snow chains.

4.10 Road safety



- ▶ Check tyre pressure before a journey or every 2 weeks. Wrong tyre pressure causes excessive wear and can lead to damage or even to tyre burst. You can lose control of the vehicle (see section 14.7).

Before commencing the journey, work through the checklist:

Base vehicle

No.	Checks	Checked
1	All vehicle documents are on board	
2	Tyres in proper condition and tyre pressure correct	
3	Vehicle lighting, brake lights and reversing lights function	
4	Oil levels for engine, gearbox and power steering controlled	
5	Coolant and fluid for windscreen washers filled up	
6	Brakes function	
7	Brakes react evenly	
8	When braking, the vehicle remains in the lane	

Housing body, outside

9	Awning completely retracted	
10	Roof free of snow and ice (in winter)	
11	External connections and lines disconnected and stored away	
12	External supports removed	
13	Fitted supports retracted and fixed in place	
14	Wheel chocks removed and stored away	

No.	Checks	Checked
15	Entrance step is stored securely or retracted	
16	External flaps closed and locked	
17	Conversion door locked	
18	Overall height of the vehicle including roof rack when loaded measured and noted. Keep the height information close at hand in the driver's cabin	

Housing body, inside

19	Windows and skylights closed and locked	
20	Flat screen secured	
21	Television antenna retracted (if one is built in)	
22	Loose parts and add-on parts stored away or fixed in position	
23	Open storage spaces empty	
24	Refrigerator door secured	
25	Refrigerator set to 12 V operation (only in case of manual power selection)	
26	All drawers and flaps closed	
27	All inner doors closed and all adjustable partition walls open and secured	
28	Children's seats mounted to seats with three-point safety belts	
29	Swivel seat locking device for driver's seat and front passenger's seat locked	
30	Shades in the driver's cabin opened and secured	

Gas system

31	Gas bottles firmly fixed in the gas bottle compartment so that they are unable to turn	
32	If the gas bottles are not connected to the gas tube, always place the protective cap on top	
33	If there is no supplied crash protection unit: Regulator tap on the gas bottle and gas isolator taps are closed	

Electrical system

34	<p>Check the battery voltage of the starter and living area battery (see chapter 9). If the panel indicates that the battery voltage is too low, the respective battery will need to be recharged. Observe the notes and instructions in chapter 9</p> <p> ▷ Commence journey with fully charged starter and living area batteries.</p>	
----	--	--

Chapter overview

This chapter contains instructions on how to drive the motorhome.

5.1 Driving



- ▶ The base vehicle is a commercial vehicle (small truck). Adjust your driving technique accordingly.
- ▶ Before commencing the journey and after short interruptions of the journey, ensure that the entrance step is completely retracted.
- ▶ A seat belt is fitted for each seat which is permitted for travel. Please keep your seat belt fastened during the journey.
- ▶ Never open your seat belts when travelling.
- ▶ Passengers must remain in the seats provided.
- ▶ The doors must remain locked.
- ▶ Avoid braking with a jerk.
- ▶ If a navigation system is used, only change the destination when the vehicle is stationary. Drive to a car park or stop in a safe area when changing the destination.
- ▶ Do not play DVDs using the monitor of the navigation system during the journey.
- ▶ Always switch off outdoor light/awning light during the journey.



- ▷ Drive slowly on poor roads.
- ▷ Take extreme care when driving onto ferries, crossing uneven roads and driving in reverse. Because of the relatively large overhang, larger vehicles might swing out and "touch ground" in unfavourable conditions. This can cause damage to the underbody or to parts fitted there.



- ▷ If an accident occurs as a result of these instructions not being observed, the manufacturer will not be responsible for damages caused.
- ▷ The safety measures stipulated in chapter 3 have to be observed.
- ▷ If a reversing camera is installed in the vehicle, the camera is automatically switched on when driving in reverse gear.

5.2 Reversing camera (partially special equipment)



Fig. 14 Reversing camera with infrared illumination

A reversing camera (Fig. 14) is installed in the vehicle.

When it is dark, the infrared LEDs of the reversing camera illuminate the field of view.

The image of the reversing camera is fed into the central multimedia/navigation system and shown on the existent LCD monitor.

If the engine is running or the ignition is switched on, the reversing camera and LCD monitor switch themselves on automatically when you engage reverse.

If the engine is running or the ignition is switched on, the reversing camera and LCD monitor can also be switched on manually via a pushbutton or a switch on the display.

The system can be switched off via an operating button or via a button on the display.



▷ Further information can be obtained in the manufacturer's instruction manual.

5.3 Driving speed



- ▶ The vehicle is equipped with a powerful engine. This means there are sufficient reserves in difficult traffic situations. This high power enables a high maximum speed and requires above-average driving ability.
- ▶ The vehicle provides a large contact surface for wind. A sudden cross-wind can be especially dangerous.
- ▶ Uneven or one-sided loading affects road performance.
- ▶ Driving on unknown streets, you may encounter hazardous road conditions and unexpected driving situations. Therefore, in the interest of safety, make sure your driving speed is appropriate to any given driving situation and environment.
- ▶ Adhere to the national legal speed limits.

5.4 Brakes



- ▶ Have defects on the braking system immediately remedied by an authorised specialist workshop.

Before each journey

Before each journey, check by means of a braking test:

- Do the brakes function?
- Do the brakes react evenly?
- Does the vehicle remain in the lane when braking?

5.5 Air suspension (special equipment)

5.5.1 General instructions



- ▶ Overloading of the vehicle cannot be observed visually in the case of an air suspension with automatic levelling.
Never exceed the axle load nor the maximum permissible gross weight.
- ▶ Never use the air suspension to lift the vehicle for servicing (e.g. changing the wheel).
- ▶ Only raise or lower the vehicle when it is stationary or moving slowly.
- ▶ Only operate the remote control, if people or objects are not in the working area under the vehicle.
- ▶ Do not allow children to play with the system.
- ▶ Only drive at a steady, low speed if there is a fault with the air suspension and have the fault immediately repaired by an authorised specialist workshop.



- ▷ Do not operate the brake pedal during lifting or lowering of the vehicle. This prevents chassis tension.
- ▷ In the case of long periods of inactivity, the vehicle level may gradually become lower. This can damage the air bellows. The following measures can therefore be adopted in the event of long periods of inactivity:
 - Use steady legs.
 - Fill the air bellows once a week with compressed air.

An air suspension keeps the vehicle at the same driving level in every loading condition. Additionally, different functions are operated manually. The increase of ground clearance simplifies e.g. driving onto ferries (bigger gradient angle).

5.5.2 Rear axle air suspension



- ▶ In the following cases, do not drive faster than 25 km/h (15 mph):
 - While the vehicle is being raised.
 - While the vehicle is being lowered.
 - When the driving level is raised or lowered.
 Then drive at a higher speed once the driving level is set.



- ▷ The distance between the tow ball of the caravan coupling and the road must be 350 to 420 mm in loaded condition.

The different functions of the air suspension can be operated manually via the remote control buttons.



- ▷ When the vehicle is stationary, the button functions are only available if the ignition is switched on.
When driving, the button functions are only available for speeds under 25 km/h (15 mph).
- ▷ If the speed exceeds 25 km/h (15 mph), the driving level is controlled automatically.

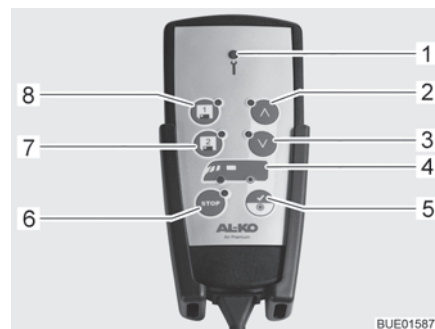















- 1 Indicator lamp
- 2 Raising the level
- 3 Lowering the level
- 4 Axle indicator
- 5 Driving level
- 6 Stop button
- 7 Storage 2
- 8 Storage 1

Fig. 15 Remote control

The following functions can be selected via the buttons:

Function	Button	Display	Signification
Start the system (switch on the ignition)		LED lights up for a second	System ready
		LED lights up	Vehicle in driving level
Set driving level	 Press shortly	LED lights up	Vehicle is set to driving level

Function	Button	Display	Signification
Raise the vehicle	 Press until the desired level has been reached	Button blinks	Vehicle is raised
	Release	Button lights up	Level reached
	 Press shortly	Button blinks	Vehicle is raised
		Button lights up	Highest level reached
Lower the vehicle	 Press until the desired level has been reached	Button blinks	Vehicle is lowered
	Release	Button lights up	Level reached
	 Press shortly	Button blinks	Vehicle is lowered
		Button lights up	Lowest level reached
Save level	 or  Press	-	Set level
	 or  Press	Sound is emitted	Setting is saved
Control saved level	 or  Press shortly	Button blinks	Level is set
		Button lights up	Level reached
Emergency stop	 Press once (during functional process)	-	All functions are immediately interrupted
	 Press twice	-	System is reactivated
Switch the system off	 Press once	Button lights up	System is switched off
Switch the service mode on/off (vehicle in park but with the ignition still switched on)	 Press shortly	Button lights up	Service mode switched on
	 Press again	Button goes out	Service mode switched off



- ▷ Further information can be obtained in the manufacturer's instruction manual.

5.5.3 Front and rear axle air suspension



- ▶ Do not exceed the speed limit while the vehicle's level is being changed or when the vehicle is **not** set at the driving level. Once the vehicle is set at the driving level, you may drive at a faster speed.



- ▷ The distance between the tow ball of the caravan coupling and the road must be 350 to 420 mm in loaded condition.

The different functions of the air suspension can be operated manually via the remote control buttons.



- ▷ When the vehicle is stationary, the button functions are only available if the ignition is switched on. When travelling, the button functions are only available up until a particular speed limit.
- ▷ If the speed limit is exceeded, the driving level is controlled automatically.

























Fig. 16 Remote control

Button	Description	Speed limit
1	Indicator lamp	-
2	Off-road position	Up to 25 km/h (15 mph)
3	Parking position	Up to 25 km/h
4	Raising the level	Up to 5 km/h (3 mph)
5	Lowering the level	Up to 5 km/h
6	Axle indicator	Up to 5 km/h
7	Driving level	Up to 25 km/h
	Manual operation	Up to 5 km/h
8	Stop button	Up to 25 km/h
9	Automatic level	-

Button	Description	Speed limit
10	Lateral inclination	Up to 5 km/h
11	Lowering the front	Up to 25 km/h
12	Lowering the rear	Up to 25 km/h

The following functions can be selected via the buttons:

Function	Button	Display	Signification
Start the system (switch on the ignition)		LED lights up for a second	System ready
		Two LEDs light up	Vehicle in driving level
Set driving level	 Press shortly	Both LEDs light up	Vehicle is set to driving level
Automatic level ¹⁾	 Press	Button blinks	Vehicle is aligned horizontally
		Button lights up for 10 seconds	Best possible position is reached
	 Press shortly	-	End the function Vehicle is reset to driving level
Axle is selected for manual use	 Press multiple times (approx. 3 seconds), until the desired axle is selected	 Axle's LED lights up	Axle is selected
Lift the vehicle (axle is selected)	 Press until the desired level has been reached	Button blinks	Vehicle is raised
	Release	Button lights up	Level reached
	 Press shortly	Button blinks	Vehicle is raised
		Button lights up	Highest level reached
Lower the vehicle (axle is selected)	 Press until the desired level has been reached	Button blinks	Vehicle is lowered
	Release	Button lights up	Level reached
	 Press shortly	Button blinks	Vehicle is lowered
		Button lights up	Lowest level reached
Off-road position (high driving position)	 Press shortly	Button blinks	Vehicle is raised
		Button lights up	Level reached

Function	Button	Display	Signification
Parking position (low driving position)	 Press shortly	Button blinks Beeping noise while the function is active	Vehicle is lowered
		Button lights up	Level reached
Lower the rear (easier to load)	 Press shortly	Button blinks	The rear of the vehicle is lowered
		Button lights up	Lowest possible level reached
Lower the front (large ground clearance in the rear area)	 Press shortly	Button blinks	The front of the vehicle is lowered
		Button lights up	Lowest possible level reached
Lateral inclination (emptying the tank)	 Press until the desired angle has been reached	Button blinks	Vehicle inclines
	Release	Button lights up	Maximum inclination angle has been reached
	 Press shortly	-	End the function Vehicle is reset to driving level
Emergency stop	 Press once (during functional process)	-	All functions are immediately interrupted
	 Press twice	-	System is reactivated
Switch the system off	 Press once	Button lights up	System is switched off
Switch the service mode on/off (vehicle in park but with the ignition still switched on)	 Press shortly	Button lights up	Service mode switched on
	 Press again	Button goes out	Service mode switched off

¹⁾ This function is available for another 6 minutes after the ignition has been switched off



▷ Further information can be obtained in the manufacturer's instruction manual.

5.6 Seat belts

5.6.1 General

The vehicle is equipped with seat belts in the living area on the seats for which seat belts are compulsory by law. National regulations apply to fastening of seat belts.



- ▶ Fasten your seat belts before the beginning of the journey and keep them fastened during the journey.
- ▶ Do not damage or trap belts. Have damaged seat belts changed by an authorised specialist workshop.
- ▶ Do not alter the belt fixing devices, automatic seat belt winders and the belt clips.
- ▶ Only use one seat belt for **one** adult person.
- ▶ Do not belt in objects together with persons.
- ▶ Seat belts are not sufficient for persons who are less than 150 cm tall. In these cases use additional restraining devices. Observe test certificate.
- ▶ Only attach the child restraint system to seats that are specified for this purpose. We strongly recommend to install child restraint systems preferably in the second row of seats.
- ▶ After an accident, replace the seat belts.
- ▶ During the journey, do not tilt the backrest too far backwards. Otherwise the functionality of the seat belt is no longer guaranteed.

5.6.2 Fastening the seat belt correctly



- ▶ Do not twist the belt. The belt must be positioned smoothly against the body.
- ▶ When fastening the seat belt, adopt the correct sitting position.

The seat belt is correctly fastened when the lap belt passes below your stomach and across the hip bone. The shoulder belt must pass across the chest and shoulder (not across your neck). The belt must always be taut against your body. Any bulky or padded clothing should therefore be removed before you start your journey.

5.7 Child restraint systems



- ▶ When travelling, secure children under 13 years of age that are smaller than 150 cm, with a suitable and officially approved child restraint system.
- ▶ Only attach the child restraint system to seats that are specified for this purpose. We strongly recommend to install child restraint systems preferably in the second row of seats.
- ▶ Fasten the childrens' seat belts before commencing the journey and make sure that their seat belts are kept fastened during the journey.
- ▶ Use a rear-facing child restraint system ("reboard system") only when the front and side air bags on the passenger side are switched off. Observe the separate operating instructions of the chassis manufacturer and the warning notices in the vehicle. If no rear-facing child restraint system is in use, switch the airbags back on again.
- ▶ Never use rearward-facing child restraint system on a seat with activated front airbag. This may lead to death or to serious injuries in children.



Fig. 17 Warning notice on child restraint system (front passenger's seat sun visor)

Rearward-facing child restraint systems on the front passenger's seat

The front passenger's seat is equipped with an airbag. When this airbag is activated, it is not permitted to use a rearward-facing child restraint system on the front passenger's seat. In the event of an accident, the triggered airbag may cause serious injuries in the child or to its death. A warning notice (Fig. 17) depicting this hazard is attached to both sides of the sun visor.

The airbag of the front passenger's seat can be deactivated. Refer to the instruction manual of the base vehicle for instructions.

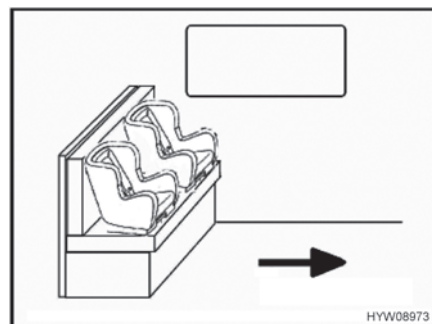

Fig. 18 Child seats on bench

Child restraint systems in the living area

The arrow in Fig. 18 shows the direction of travel.

- Lower the table.

Child restraint systems are divided into five classes:

Class	Body weight	Approximate age
0	Up to 10 kg	Up to 9 months
0+	Up to 13 kg	Up to 18 months
I	9 kg to 18 kg	9 months to 4 years
II	15 kg to 25 kg	3 years to 7 ½ years
III	22 kg to 36 kg	6 years to 12 years

The following table shows, which child restraint systems can be used on which seats.

Seats	Age groups			
	< 10 kg (0-9 months)	< 13 kg (0-24 months)	9-18 kg (9-48 months)	15-36 kg (4-12 years)
Front passenger's seat	X	U ¹⁾	U ¹⁾	U ¹⁾
Second and third row of seats	U ²⁾	U	U	U
Here, the following meanings apply:				
U:	Suitable for "universal" restraint systems which are authorised for this age group.			
X:	Seat is not suitable for children in this age group.			

- ¹⁾ This only applies without airbag or with deactivated airbag.
- ²⁾ Only possible in the respective seat if the distance between the seat and the table is large enough or if the table has been removed.

5.8 Pilot seats for the driver's and front passenger's seats



- ▶ Before commencing the journey, rotate all swivel seats in the direction of travel and lock in position.
- ▶ The seats must remain fixed in position during the journey and are not to be rotated.



- ▷ Before rotating the seats in the pitched vehicle, always apply the hand-brake.



- ▷ The driver's seat and the front passenger's seat are part of the base vehicle. The adjustment of the seats is described in the instruction manual of the base vehicle.

5.9 Seat heater (special equipment)



▷ The seat heater only works when the ignition is switched on.

Depending on equipment levels, the driver's seat and the front passenger's seat may have a 2-level seat heater.

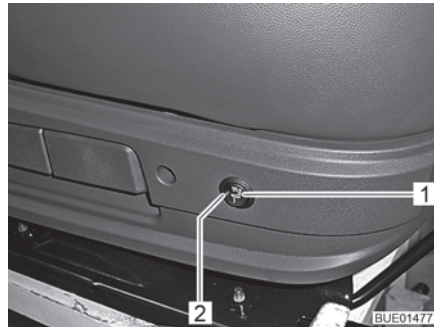

Fig. 19 Switch for seat heater

Switching on the seat heater:

- Press the switch (Fig. 19,1) at the back on the left side of the seat console.
 - For minimal heating: Press the switch so that it is in the down position.
 - For the highest heat level: Press the switch so that it is in the up position.

The LED (Fig. 19,2) comes on when the seat heater is in use.

Switching off the seat heater:

- Set switch (Fig. 19,1) to the middle position. The LED goes out.

5.10 Headrests

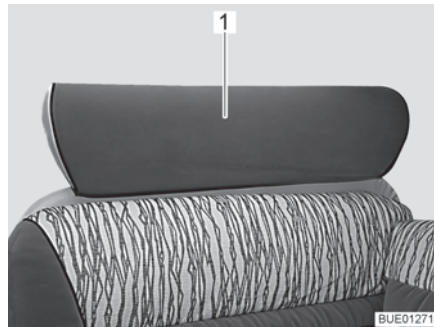

Fig. 20 Bench headrest, one-part

Before commencing the journey, adjust the headrest (Fig. 20,1) so that the back of the head is supported at approximately ear height.

Push the headrests upwards or downwards by hand.

5.11 Seating arrangement



- ▶ During the journey, persons are only to sit on the permitted seats. The authorised number of seats is stipulated in the vehicle documents.
- ▶ During the journey sitting on the divans is not permitted.
- ▶ Seat belts must be worn by all passengers.



Fig. 21 Symbol "Do not use seat during the journey"

Seats which may not be used during the journey are equipped with a sticker (Fig. 21).

5.12 Roman shade in the driver's cabin

5.12.1 Pleated Roman shades



- ▶ When on the move, the Roman shades for the windscreen, driver's window and the front passenger's window respectively must be completely removed.



Fig. 22 Pleated Roman shades

Removing the pleated shade:

- Open the snap fasteners (Fig. 22,1), loosen the magnetic strips and detach the pleated shade from the window (shown here on the passenger window).
- Stow away the pleated shades in the living area.

5.12.2 Roman shades, Remis (special equipment)



- ▶ While travelling, the Roman shades for the windscreen, driver's window and front passenger's window must be open, in a fixed position and secured.

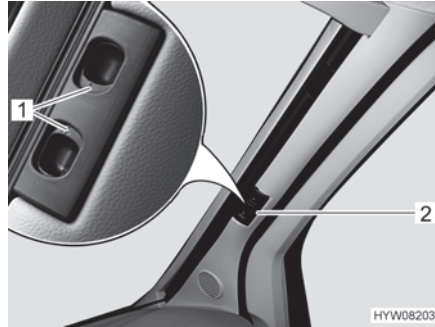

Fig. 23 Roman shade for the windscreen

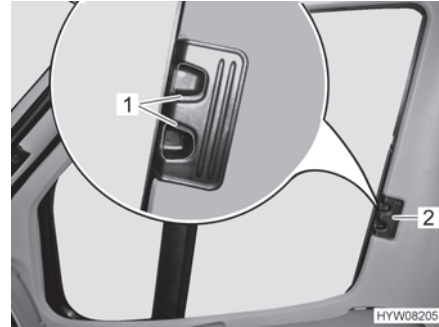

Fig. 24 Roman shade for driver's and passenger's window

- Securing:
- Use the handle (Fig. 23,2) to pull the two halves of the Roman shade for the windscreen outwards as far as they will go. When doing so, move the handle horizontally in the direction of the locking recess.
 - Allow the release handles (Fig. 23,1) to engage.
 - Use handle (Fig. 24,2) to push in the Roman shades for the driver's and passenger's window as far as possible.
 - Allow the release handles (Fig. 24,1) to engage.

5.13 Refuelling



- ▶ All gas-operated devices must be switched off for refuelling (heater, cooker, oven, grill, refrigerator - depending on the equipment). Danger of explosion!



- ▷ The fuel filler neck is part of the base vehicle.
- ▷ The fuel filler neck is labelled with the word "Diesel".

Refer to the instruction manual for the base vehicle for the position of the fuel filler neck.

Chapter overview

This chapter contains instructions on how to pitch the vehicle.

6.1 Handbrake

Firmly apply the handbrake when parking the vehicle.

6.2 Entrance step

In order to exit the vehicle, first fully extend the entrance step. Observe the indicator lamp on the dashboard.

For operating the entrance step, see section 4.6.

6.3 Ramps



- ▷ Ramps are not included in the scope of delivery. Different models are available from accessory shops.

To enable the vehicle to be parked on the level, ramps can be used for height compensation when the vehicle is parked on a hill or on uneven ground.

6.4 Wheel chocks

When parking the vehicle on slopes or inclines use the wheel chocks.

If the maximum permissible gross weight of the vehicle exceeds 4 tonnes, wheel chocks must be used when parking on gradients. The wheel chocks are provided as standard for vehicles with a maximum permissible gross weight exceeding 4 tonnes.

6.5 Supports

6.5.1 General instructions



- ▶ The steady legs must not be used to jack up the vehicle in order to work beneath it, e.g. to change a wheel or carry out maintenance work.
- ▶ Whilst the vehicle is in a jacked up position, persons must not lie down under it.



- ▷ Always apply the handbrake before extending the steady legs.
- ▷ Do not use the fitted supports as a vehicle jack. They supports are only for stabilising the parked vehicle to prevent the rear axle from bottoming out.
- ▷ When pitching the vehicle, ensure that the supports are evenly loaded.
- ▷ Before driving away, wind up the supports as far as they can go, fully retract and secure them.



- ▷ When the ground is soft, place a pad or block under the supports in order to prevent the vehicle from sinking into the ground.
- ▷ Pitch the vehicle so that it is as horizontal as possible. Otherwise, the water from the shower tray will not be able to drain properly.

6.5.2 Steady legs (AL-KO) (partially special equipment)

In order to ensure their correct function, clean and grease the interior tubes of the steady legs regularly.

The length of the steady legs can be adjusted according to the model.

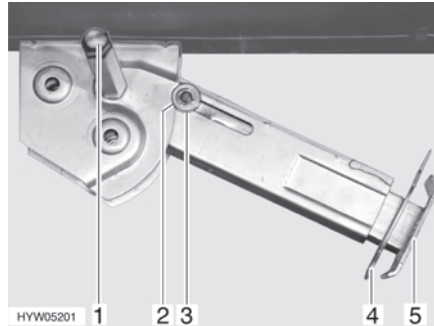

Fig. 25 Steady leg

- Extending:**
- Place the socket spanner on the hexagon nut (Fig. 25,1) and rotate until the steady leg is in a perpendicular downward position.
 - Remove the splint (Fig. 25,4) out of the support foot extension (Fig. 25,5).
 - Extend the support foot extension until it has reached the required length.
 - Insert the splint in the support foot extension.
 - Rotate the hexagonal nut until the steady leg rests completely on the ground and the vehicle is in a horizontal position.
- Retracting:**
- Place the socket spanner on the hexagon nut (Fig. 25,1) and rotate until the steady leg is clear of the ground.
 - Remove the splint (Fig. 25,4) out of the support foot extension (Fig. 25,5).
 - Push in the support foot extension (Fig. 25,5) and insert the splint (Fig. 25,4) in the drilled hole in the support foot extension.
 - Rotate the hexagonal nut (Fig. 25,1) with the socket spanner until the steady leg has swung upwards and the guide disc (Fig. 25,3) has completely retracted into the notch (Fig. 25,2).
- ▷ Before commencing the journey, observe the following: Are all steady legs and support foot extensions retracted completely and secured with the splint?



6.6 230 V connection

The vehicle can be connected to a 230 V power supply (see chapter 9).

6.7 Refrigerator



- ▶ If the refrigerator is set to 12 V operation, it will constantly consume current. Therefore, switch over to gas operation when the vehicle engine is **not** running, and the vehicle is **not** connected to the 230 V power supply.

In the case of appliances with automatic power selection, the 12 V operation of the refrigerator will only be selected in the automatic mode when the vehicle engine is running.

In the case of appliances with manual power selection: When the vehicle engine is switched off, switch the refrigerator to 230 V operation or gas operation.

6.8 Satellite unit (special equipment)



- ▶ Before commencing the journey, ensure that the antenna is in park position. Danger of accidents!



- ▷ Before switching on the satellite unit, make sure that there is no obstacle in the way, e.g. a branch or the garage roof, while erecting the antenna.
- ▷ Move the antenna into parking position in the event of strong wind (above 80 km/h).
- ▷ Do not wash a vehicle with a satellite antenna in a brush washing system, nor in a vehicle washing installation, nor with high-pressure cleaners.
- ▷ In the event of backward shipping, e.g. by truck or train, secure antenna against unintentional erection.



- ▷ The vehicle must be still during the satellite search. Do not walk through the vehicle.
- ▷ Satellite reception is only possible, when the antenna is positioned in direct line of sight of the chosen satellite and the view is not blocked in any way.
- ▷ Further information can be obtained in the device manufacturer's instruction manual.

6.9 Satellite unit with manual satellite selection (TeleSat)

The selection of the desired satellite is carried out on the operating panel of the unit. The automatic advance unit ensures that the antenna is precisely aligned to the desired satellite.

When switching on the unit, the antenna is extended automatically. When switching off the unit and when starting the vehicle engine, the antenna is retracted automatically.

The satellite unit is operated via the operating panel. When the antenna is moving (retracting/extending or satellite search), this is indicated by an animation on the display.

The operating panel changes into standby mode after a few seconds without any operation.

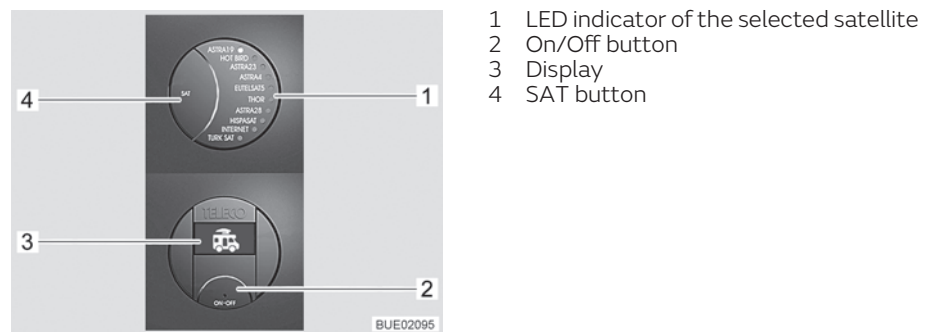

Fig. 26 Operating panel (TeleSat)

Switching on the unit:

- Press the On/Off button (Fig. 26,2). The LED indicator of the selected satellite (Fig. 26,1) and the background lighting of the buttons are lit. The symbol of the vehicle with retracted antenna appears on the display (Fig. 26,3).
- Press the On/Off button (Fig. 26,2) again. The system has been switched on. If the antenna had been retracted, it will now extend to operating position. If the LED of the desired satellite (Fig. 26,1) is already flashing, wait a few seconds. The antenna automatically aligns with this satellite (the last satellite position is saved after switching off). When the unit has found the satellite, the LED (Fig. 26,1) is lit permanently and "SAT OK" is shown on the display (Fig. 26,3).
- Switch on the SAT receiver and select the desired television channel.

Choosing a satellite:

- Press the SAT button (Fig. 26,4) repeatedly until the LED (Fig. 26,1) indicates the desired satellite. The antenna automatically aligns with this satellite.
- When the unit has found the satellite, the LED (Fig. 26,1) is lit permanently and "SAT OK" is shown on the display (Fig. 26,3).

Switching off the unit:

- Press the On/Off button (Fig. 26,2). The LED indicator of the selected satellite (Fig. 26,1) and the background lighting of the buttons are lit. The currently selected satellite is shown on the display (Fig. 26,3).
- Press the On/Off button (Fig. 26,2) again. The antenna retracts. When the antenna has been fully retracted, the symbol of the vehicle with retracted antenna is shown on the display. The system changes to the standby mode after a few seconds.

6.10 Satellite unit with automatic antenna alignment (Teleco)

The satellite unit is equipped with an automatic advance unit. This automatic advance unit ensures that the antenna is aligned precisely.

When switching on the unit, the antenna is extended automatically. When switching off the unit or when starting the vehicle engine, the antenna is retracted automatically.

When the desired TV programme is chosen, the corresponding satellite is selected and aimed at automatically.

The satellite unit is operated via remote control. Optionally, a simplified remote control is available.



- 1 Television on/off button
- 2 AUTO button (advance unit and television on/off)
- 3 INPUT button (selection of the signal source)
- 4 Programme selection buttons

Fig. 27 Remote control

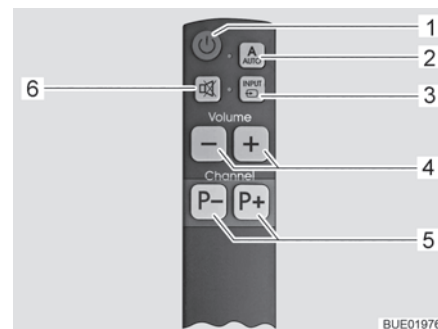

- 1 Television on/off button
- 2 AUTO button (advance unit and television on/off)
- 3 INPUT button (selection of the signal source)
- 4 Volume buttons
- 5 Programme selection buttons
- 6 Mute button

Fig. 28 Simplified remote control (optional)

Switching on the unit:

- Press the AUTO button (Fig. 27,2 or Fig. 28,2) for 1 second. Thus, the television and the advance unit are switched on.

If the antenna had been retracted, it will now extend to operating position. The antenna then automatically starts searching for the satellite suitable for the set TV programme.

When the unit finds the satellite, the TV programme appears automatically.

Choosing a TV programme:

- Press the programme selection buttons (Fig. 27,4 or Fig. 28,5) until the desired TV programme has been selected.

The antenna automatically searches for the suitable satellite.

When the unit finds the satellite, the TV programme appears automatically.

- Choosing the signal source:**
- Press the INPUT button (Fig. 27,3 or Fig. 28,3) repeatedly until the desired signal source has been selected.
 - To return to the satellite channels display, press the INPUT button (Fig. 27,3 or Fig. 28,3) repeatedly until the signal source DVB-S2 has been selected.

- Switching off the unit:**
- Press the AUTO button (Fig. 27,2 or Fig. 28,2).

The antenna automatically moves into parking position. When reaching the parking position, this is displayed on the screen.

The television and advance unit switch off after a few seconds.

- Operating the unit without using the antenna:**
- Press the Television on/off button (Fig. 27,1 or Fig. 28,1). The advance unit is not switched on, the antenna remains in parking position.
 - Press the INPUT button (Fig. 27,3 or Fig. 28,3) repeatedly until the desired signal source (e.g. DVD) has been selected.
 - Press the Television on/off button (Fig. 27,1 or Fig. 28,1) to switch the television off.

6.11 Satellite unit with automatic antenna alignment (Oyster Premium)



- ▷ In the event of a longer stationary period, disconnect the flat screen from the power supply with the flip switch to prevent the living area battery from getting discharged.



- ▷ If the location is adjusted with the help of the list of countries, the satellite search will be accelerated.
- ▷ If the antenna has been retracted by switching on the ignition, it is required to restart the system by switching it off and on.
- ▷ The reception of DVB-T/T2 channels (digital terrestrial television) is only possible if there is a DVB-T/T2 antenna present.

The antenna will automatically be aligned with a pre adjusted satellite if the receiver system is within the reach of this satellite.

When switching on the unit, the antenna is extended automatically. When switching off the unit or when starting the vehicle engine, the antenna is retracted automatically.

When the desired TV programme is chosen, the corresponding satellite is selected and aimed at automatically.

The remote control's basic operating functions are listed here; refer to the manufacturer's separate instruction manual for a full description.

The system is equipped in the factory with list of standard channels as well as lists of favourites. You can change or add to these standard lists manually as desired.

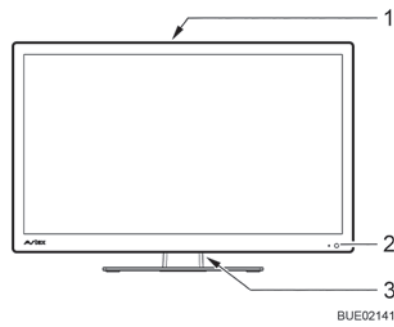

- 1 Operating buttons on the back of the device
- 2 Standby mode/operation LED
- 3 ON/OFF flip switch

Fig. 29 Operation on the flat screen

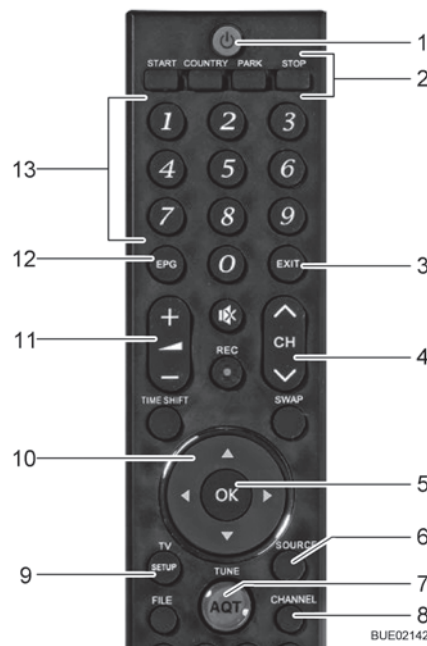

- 1 POWER button
- 2 Manual control of antenna
- 3 EXIT button - exit menu without saving
- 4 Programme selection button
- 5 OK button - confirm selection or save setting
- 6 SOURCE button - select signal source
- 7 AQT button - start DVB-T/T2 channel scan
- 8 CHANNEL button - call list of channels
- 9 SETUP button - call main menu
- 10 Navigation buttons in the menu
- 11 Volume button
- 12 EPG button - programme guide
- 13 Numeric keys - call programme channel directly or enter numbers

Fig. 30 Remote control

Switching on the unit:

- Set flip switch (Fig. 29,3) on the flat screen's back to ON. The system changes to standby mode. The LED (Fig. 29,2) is lit red.

Further operation is performed via the remote control and the indicators displayed on the flat screen.

- Press the POWER button (Fig. 30,1) on the remote control. The LED (Fig. 29,2) is lit blue.

Choosing a TV programme:

- Press the programme selection buttons (Fig. 30,4 or Fig. 30,13) until the desired TV programme has been selected.

The antenna automatically searches for the suitable satellite.

When the unit finds the satellite, the TV programme appears automatically.

Choosing the signal source:

- Press the SOURCE button (Fig. 30,6) repeatedly until the desired signal source has been selected.
- To return to the satellite channels display, press the SOURCE button repeatedly until the signal source DVB-S has been selected.

Operating the unit without using the antenna:

- Press the PARK button (Fig. 30,2). The antenna moves into parking position.
- Press the SOURCE button (Fig. 30,6) repeatedly until the desired signal source (e.g. DVD) has been selected.

Switching off the unit:

- Press the POWER button (Fig. 30,1) on the remote control. The system changes to standby mode. The LED (Fig. 29,2) is lit red.
- Set flip switch (Fig. 29,3) on the flat screen's back to OFF.

The system is disconnected from the power supply.

The antenna automatically moves into parking position.

6.12 Awning (special equipment)



- ▷ Retract the awning in strong wind, rain or snow.
- ▷ In the case of light rain, shorten one of the support legs so that water can run off.
- ▷ Only retract the awning when the fabric is dry. When the awning must be retracted while the fabric is still wet: Extend the awning as soon as possible, in order to dry out the fabric.
- ▷ Before retracting, remove leaves and coarse dirt from the awning.



- ▷ Only use the awning for protection against the sun.
- ▷ Also read the manufacturer's instruction manual.

Advantages of the awning

The advantages of an awning are:

- The awning provides shade.
- The awning creates a covered vestibule and thus expands the space.
- The vehicle thus becomes more homelike.
- The integrated LED lighting (special equipment) provides additional light.



Fig. 31 Awning

Putting up the awning:

- Use the manual crank to open up the awning (Fig. 31,1).
- Set up the brackets (Fig. 31,2) when the awning is open.

Chapter overview

This chapter contains instructions about living in the vehicle.

7.1 Central locking system (special equipment)



- ▷ The central locking mechanism locks the driver's door, the passenger's door and the conversion entrance door of the body.
- ▷ The central locking system has no function, if the battery cut-off switch on the transformer/rectifier is switched off.

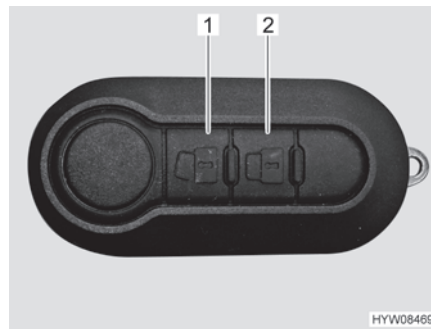

Fig. 32 Remote control for central locking system (2 buttons)

Unlocking doors:

- Press the  button (Fig. 32,1) once briefly. The door locks are unlatched.

Locking doors:

- Press the  button (Fig. 32,2) once briefly. The door locks are locked.

Multifunctional remote control for central locking system

Depending on the equipment, the vehicle will be equipped with a remote control with 3 buttons.

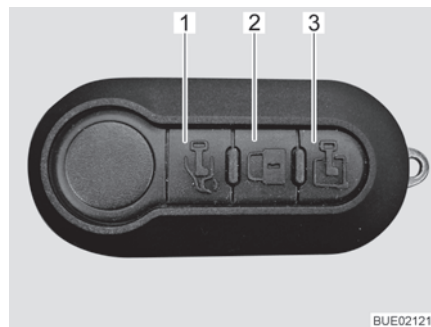



Fig. 33 Multifunctional remote control (3 buttons)

Unlocking driver's door:

- Press the  button (Fig. 33,1) once briefly. The driver's door is unlocked.

Unlocking conversion door:

- Press the  button (Fig. 33,3) once briefly. The conversion door is unlocked.

Locking all doors:

- Press the  button (Fig. 33,2) once briefly. All doors have been locked.

If one or more doors have not been correctly closed, the direction indicators will be flashing rapidly.



- ▷ Further information can be found in the instruction manual of the base vehicle.

7.2 Conversion door



- ▶ Only drive with locked doors.



- ▷ Locking the doors can prevent them from opening of their own accord, e.g. during an accident.
- ▷ Locked doors also prevent forced entry, e.g. when waiting at traffic lights. However, in an emergency, locked doors make it more difficult for helpers to enter the vehicle.
- ▷ When leaving the vehicle, always lock the doors.

7.2.1 Conversion door, outside

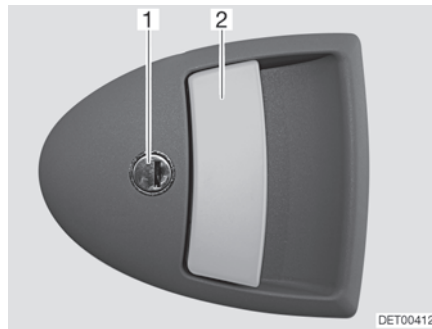

Fig. 34 Door lock of conversion door, outside

- Opening:**
- Insert the key into locking cylinder (Fig. 34,1) and turn until the door lock is unlatched.
 - Return the key to the central position and remove it.
 - Pull on the door handle (Fig. 34,2). The door is open.
- Locking:**
- Insert the key into locking cylinder (Fig. 34,1) and turn until the door lock is engaged.
 - Return the key to the central position and remove it.

7.2.2 Conversion door, inside

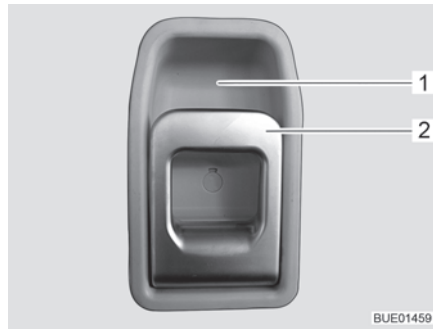

Fig. 35 Door lock of conversion door, inside

- Opening:** ■ Pull on the handle (Fig. 35,2). The door lock is unlatched.
- Locking:** ■ Press the upper part of the handle (Fig. 35,2) in the direction of the recessed handle (Fig. 35,1).

7.2.3 Window of conversion door (partially special equipment)

The conversion door window is fitted with a Roman shade.

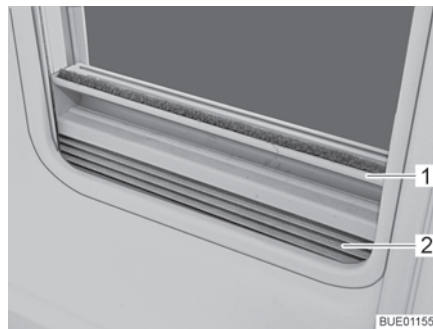

Fig. 36 Roman shade

- Closing:** ■ Grip the Roman shade (Fig. 36,2) in the middle of the holding bar (Fig. 36,1), pull it upwards and then release it at the desired height. The Roman shade will stay at this height.
- Opening:** ■ Grip the Roman shade in the middle of the holding bar and push it down.

7.2.4 Folding insect screen on the conversion door (partially special equipment)



- ▷ Open the insect screen completely before closing the conversion door.



Fig. 37 Insect screen

- Closing:** ■ Pull out the insect screen completely by the bar (Fig. 37,1).
- Opening:** ■ Push the insect screen into its initial position by the bar (Fig. 37,1).

7.3 External flaps



- ▷ Before commencing the journey, close all external flaps and lock them.
- ▷ To open and close the external flap, open or close all locks that are fitted to the external flap.



- ▷ When leaving the vehicle, close all external flaps.

The external flaps fitted to the vehicle are all fitted with identical locking cylinders. Therefore, all locks can be opened with a single key.

7.3.1 Flap lock with recessed handle



- ▷ To open the external flap, pull all the lock handles fitted to that particular external flap at the same time.

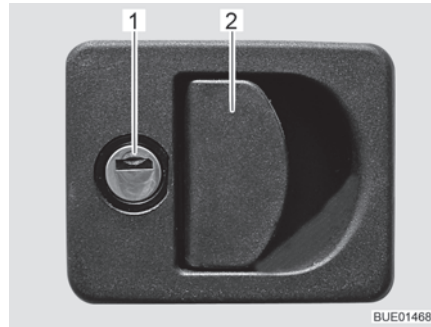

- 1 Locking cylinder
2 Lock handle

Fig. 38 Flap lock with recessed handle

- Opening:**
- Insert key into locking cylinder (Fig. 38,1) and turn a quarter turn. The flap lock is unlatched.
 - Remove the key.
 - Pull on the lock handle (Fig. 38,2). The external flap is open.
- Closing:**
- Firmly close the external flap.
 - Insert key into locking cylinder and turn a quarter turn. The flap lock is locked.
 - Remove the key.

7.3.2 Flap lock, square

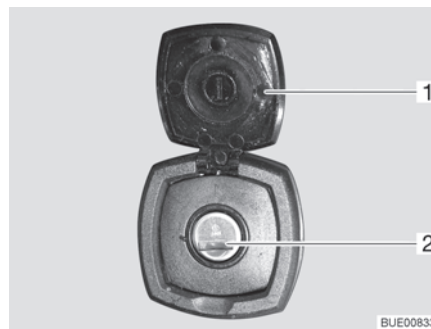

- 1 Cap
2 Locking cylinder

Fig. 39 Flap lock, square

- Opening:**
- Open the cap (Fig. 39,1).
 - Insert key into locking cylinder (Fig. 39,2) and turn a quarter turn.
 - Remove the key.
- Closing:**
- Firmly close the external flap.
 - Insert key into locking cylinder.
 - Turn key one quarter turn.
 - Remove the key.

7.3.3 Garage flap emergency release

The garage flap can be opened from the interior using the emergency release. The emergency release is even possible if the garage flap has been locked with the key.



Fig. 40 Garage flap emergency release

- Unlocking the garage flap:
- Pull both handles of the emergency release (Fig. 40,2).
 - Push the garage flap (Fig. 40,1) outwards.

7.3.4 Flap lock with push button

Depending on the flap size the service flap is equipped with one or two lockable push-button locks.



Fig. 41 Service flap push-button lock

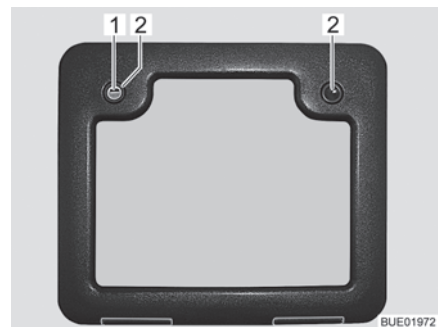
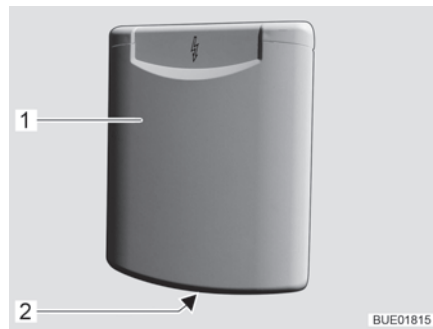

Fig. 42 Service flap push-button lock (alternative)

- Opening:
- Insert the key into locking cylinder of the lockable push-button lock (Fig. 41,1 or Fig. 42,1) and turn a quarter turn. The push-button lock is unlatched.
 - Remove the key.
 - If equipped, unlock the second lockable push-button lock as well.
 - Press the two push buttons (Fig. 42,2) of the push-button locks simultaneously with the thumb and open the service flap.
- Closing:
- Close the service flap and press it shut. The push-button locks are now engaged but not locked.
 - Insert the key into locking cylinder of the lockable push-button lock (Fig. 41,1 or Fig. 42,1) and turn a quarter turn. The push-button lock is locked.
 - Remove the key.
 - If equipped, lock the second lockable push-button lock as well.

7.3.5 Flap for the 230 V connection, square



- 1 External flap
- 2 Recessed grip

Fig. 43 Flap for the 230 V connection

- Opening:**
- Reach into the recessed grip (Fig. 43,2) on the external flap (Fig. 43,1) and swing the external flap upward.
- Closing:**
- Swivel the external flap downwards and press it shut.

7.3.6 Cap for the drinking water filler neck

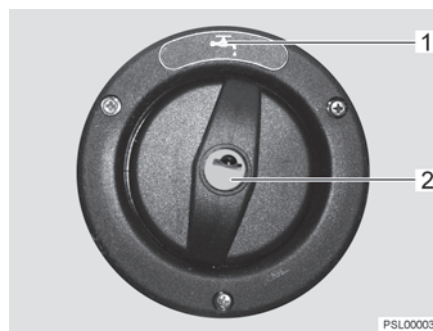

Fig. 44 Cap for the drinking water filler neck



▷ The drinking water filler neck is indicated by the symbol "☕" (Fig. 44,1).

- Opening:**
- Insert the key in the locking cylinder (Fig. 44,2) and turn it in an anticlockwise direction.
 - Remove cap.
- Closing:**
- Insert the cap in the drinking water filler neck.
 - Turn key in a clockwise direction.
 - Remove the key.

7.4 Furniture flaps and inner doors



- ▷ Before commencing the journey, close all furniture flaps and inner doors and lock them.
- ▷ The furniture flaps shown in this section are examples. Depending on the model, the locks and handles on the furniture flaps may differ to those displayed here.

7.4.1 Furniture flaps with push button

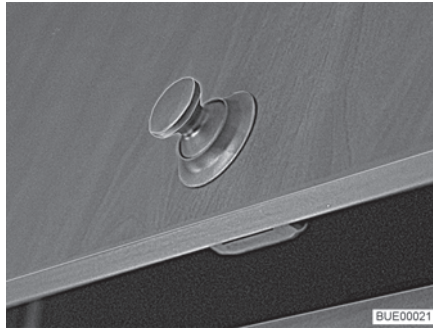

Fig. 45 Furniture flap with round push button

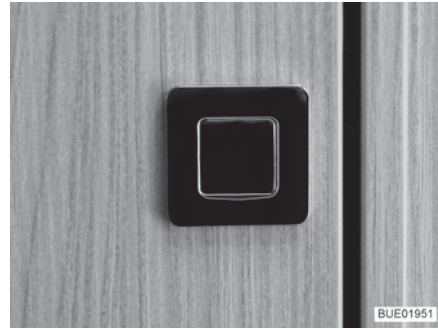

Fig. 46 Furniture flap with rectangular push button

- Opening:**
- Press inner part of the lock. The push button (Fig. 45 or Fig. 46) jumps out.
 - Hold push button and open furniture flap.
- Closing:**
- Press furniture flap shut.
 - Press push button in until it locks. The furniture flap is closed correctly when the fastener locks into place.

7.4.2 Furniture flaps with release handle

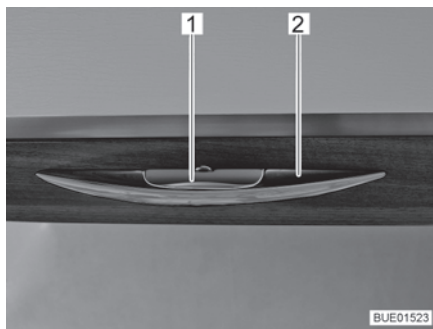

Fig. 47 Furniture flap with release handle

- Opening:**
- Press the release handle (Fig. 47,1) and hold it down.
 - Pull the handle (Fig. 47,2) until the furniture flap is open.
- Closing:**
- Press the furniture flap down until you can feel the flap hinge close and hear the lock snap into place.

7.4.3 Furniture flaps with handle and push button

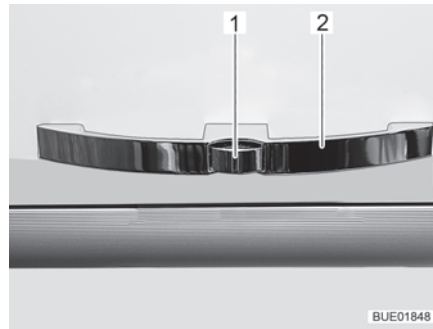

Fig. 48 Furniture flap with handle (example)

- Opening:**
- Press the release knob (Fig. 48,1) on the handle (Fig. 48,2) and hold it down.
 - Pull handle until furniture flap is open.
- Closing:**
- Press the furniture flap down until you can feel the flap hinge close and hear the lock snap into place.

7.4.4 Floor compartment cover

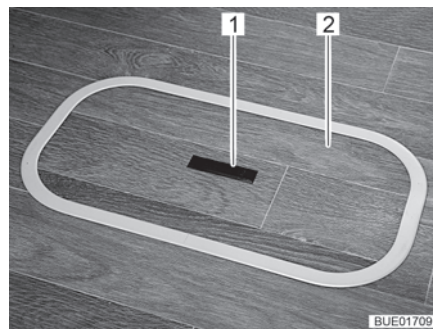

Fig. 49 Floor compartment cover (handle recessed)

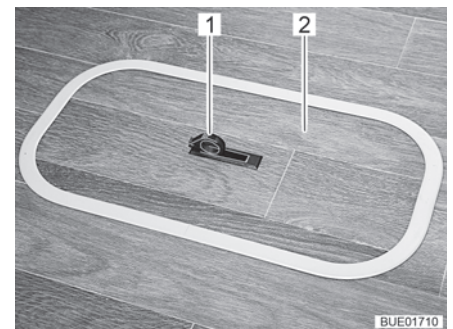

Fig. 50 Floor compartment cover (handle swung out)

- Opening:**
- Push one side of the grip plate (Fig. 49,1) downwards. The handle (Fig. 50,1) swivels upwards.
 - Remove the cover (Fig. 49,2 or Fig. 50,2) upwards.
- Closing:**
- Insert the cover in the frame on the floor.
 - Swivel handle downwards.

7.4.5 Driver's cabin partition



▷ Drive only with the driver's cabin partition secured.

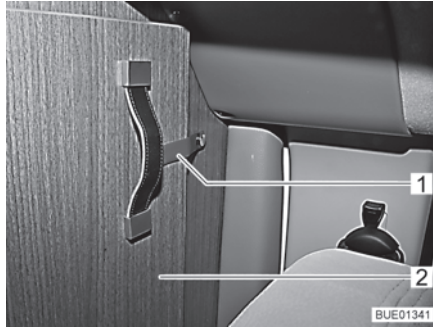

Fig. 51 Securing strap

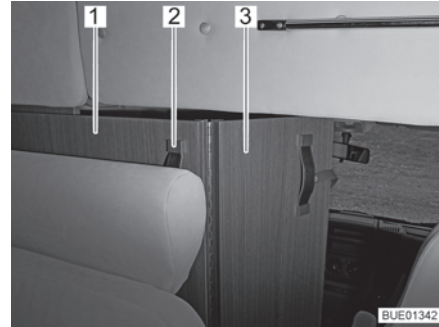

Fig. 52 Driver's cabin partition

- Closing:**
- Release the securing strap (Fig. 51,1) from the foldable section of the driver's cabin partition (Fig. 51,2).
 - Grip the handle (Fig. 52,2) of the driver's cabin partition (Fig. 52,1) and pull it inwards until the edge of the driver's cabin partition is roughly level with the backrest of the bench seat (Fig. 52).
 - Fold out the folding part of the driver's cabin partition (Fig. 52,3) between the seats of the driver's cabin.

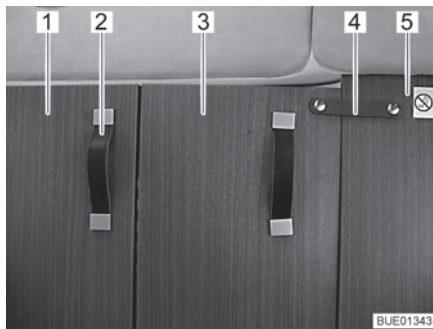

Fig. 53 Driver's cabin partition, closed

- Pull the driver's cabin partition (Fig. 53,1) completely inwards using the handle (Fig. 53,2).
 - Using the securing strap (Fig. 53,4), secure the folding section of the driver's cabin partition (Fig. 53,3) to the fixed partition wall (Fig. 53,5) behind the front passenger seat.
- Opening:**
- Open and secure the driver's cabin partition in the reverse order of the closing process.

7.5 Light switch

7.5.1 Entrance area



▷ The light switches shown in this section are examples. Depending on the model, the type and allocation of the light switches may differ to those displayed here.

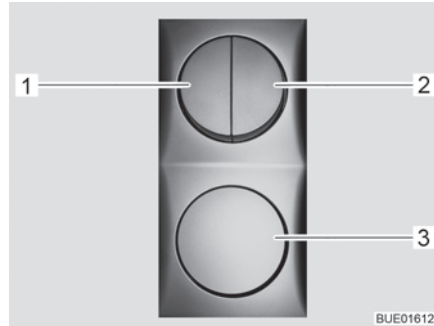

Fig. 54 Light switch



Fig. 55 Awning light

The entrance area has light switches (Fig. 54,1-3) for the following lamps:

- Entrance lights
- Awning lights
- Living area lights
- Canvas blind lighting (special equipment)

7.5.2 Interior



▷ The lamps shown in this section are examples. Not all lamps used in the vehicle are shown. The examples are intended to clarify the possible positions for the light switches. The type and appearance of the light switches can deviate from those shown here.

▷ Depending on the equipment, there may also be the option of switching lights on and off in groups with separate light switches.

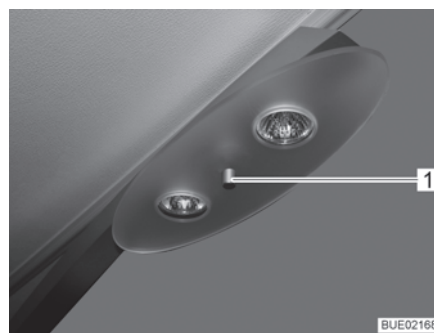

Fig. 56 Spotlight, switch mounted directly on the lamp

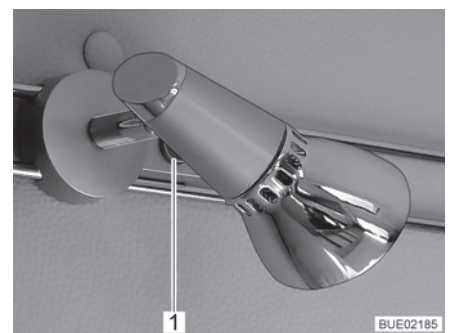

Fig. 57 Spotlight, switch mounted directly on the lamp

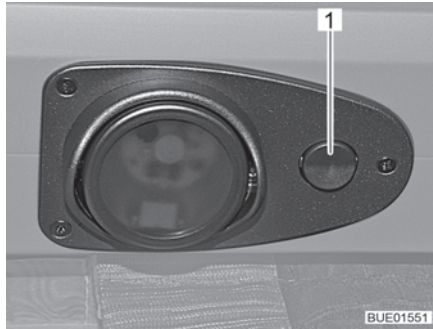

Fig. 58 Recessed LED light, light switch directly on the lamp

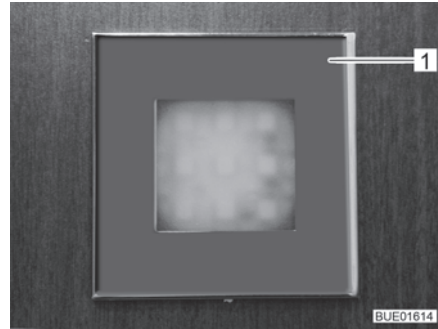

Fig. 59 Spotlight

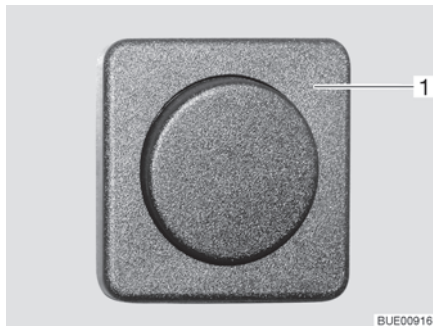

Fig. 60 Switch, separate from the lamp (example)

The light switches in the interior are located either on the lamp itself (Fig. 56,1, Fig. 57,1, Fig. 58,1) or near the lamp (Fig. 59,1 and Fig. 60,1).

7.6 Spotlight



- ▶ Bulbs and light fittings can be extremely hot.
- ▶ Allow the light bulbs and lamp holders to cool down before touching them.
- ▶ If the light is switched on or still hot, there must always be a safety distance of at least 30 cm between stores or curtains and flammable objects. Fire hazard!

The spotlight can be rotated, moved or detached.

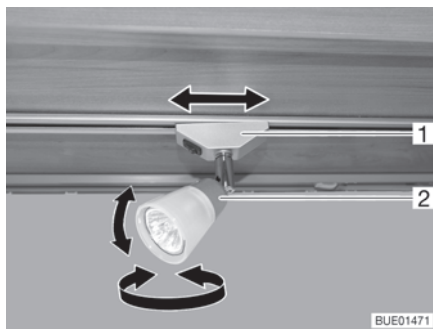

Fig. 61 Spotlight

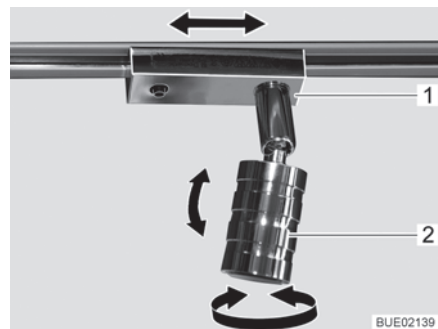

Fig. 62 Spotlight (alternative)

Rotating: ■ Grasp the housing (Fig. 61,2 or Fig. 62,2) and turn it.

The housing can be turned in different directions:

- To the left and to the right
- Up and down

Shifting: ■ Grip socket (Fig. 61,1 or Fig. 62,1) and turn by approx. 45°.
 ■ Push spotlight along the rail system to desired position.
 ■ Turn socket back.

Removing: ■ Grip socket (Fig. 61,1 or Fig. 62,1) and turn by 90°.
 ■ Remove spotlight from rail.

The spotlight can be installed in any position into the rails.

7.7 Light control

Functions

Depending on the model, the vehicle is fitted with a central lighting system. This lighting system operates and dims single lamps or lamp groups that form part of the lighting system.

Furthermore, scene functions are integrated into the lighting system. These scene functions enable the user to save and automatically recall the desired brightness of all lamp groups.



▷ The lights that are not integrated into the lighting system (e.g. kitchen light, bathroom light or reading spotlights) are switched on and off via separate light switches.

Light switch

The lights that are integrated into the lighting system are controlled via buttons on the panel (Fig. 63) or via buttons on two switches (Fig. 64 and Fig. 65). The switches are installed at various points in the vehicle.

Buttons on the panel

All light control functions are available on the panel.



Fig. 63 Panel

Buttons on the switch Not all light control functions are available on the two switches.









Fig. 64 Buttons in the living area



Fig. 65 Buttons in the living or sleeping area

Symbols The symbols listed in the following table always have the same meaning.

Symbol	Signification
M	Light scene
	Main light, living area
	Indirect lighting, living area
	Main light, sleeping area
	Indirect lighting, sleeping area
	Night light
	All lights "OFF"

Operation Each button has different functions:

Button	Press shortly	Keep pressed
Scene	Switch the preset scene on/off	Save the current scene setting (> 3 seconds, until all lamps which are switched on flicker briefly)
Light	Switch the appropriate lamp on/off	Dim the appropriate lamp (> 1 second)

7.8 Holder for flat screen



- ▶ Before commencing the journey, place and secure the flat screen and screen support in the initial position. If the screen holder is installed in a TV cabinet: Close TV cabinet.

7.8.1 Holder on the column

The holder for the flat screen is attached to a column.

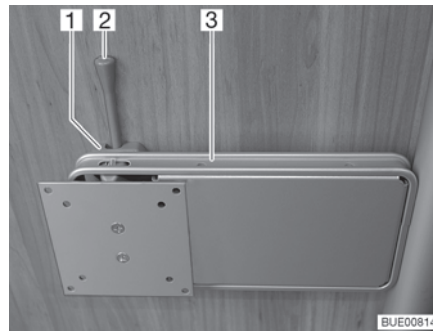

Fig. 66 Holder on the column

- Positioning:**
- Push the release lever (Fig. 66,2) to the side and turn the holder (Fig. 66,3) with the flat screen to the desired position.
 - Press the flat screen slightly upwards and swivel it to the desired position. Three different inclination angles may be used.
- Storing away:**
- Turn the flat screen back until the holder (Fig. 66,3) engages in the lock (Fig. 66,1).

7.9 Ventilation



- ▶ The oxygen in the vehicle interior is used up by breathing and the use of gas operated appliances. That is why the used air must be replaced permanently. For this purpose, forced ventilation options (e.g. skylights with forced ventilation, mushroom-shaped vents or floor vents) are fitted to the vehicle. Never cover or block forced ventilations from the inside or outside with objects such as e.g. a winter mat. Keep forced ventilations clear of snow and leaves. There is a danger of suffocation due to increased CO₂ levels.



- ▷ Although sufficient ventilation is provided, in certain weather conditions, condensation can form on metal objects (e.g. screwed connections in the floor).
- ▷ Additional cold spots can occur at thermal "bridges" (e.g. mushroom-shaped vents, skylight edges, sockets, filler necks, flaps, etc.).

Condensation Ensure that there is a continuous exchange of air by providing frequent and efficient ventilation. This is the only method for ensuring that condensation and resulting mould is not formed during cool weather. During the colder season, a pleasant living climate is created if heating output, air distribution and ventilation are synchronised. To avoid draft close the air outlet nozzles on the dashboard and set the air distribution of the base vehicle to air circulation. If the vehicle is laid up for a longer period, occasionally ventilate it well, especially in summer as heat accumulation can occur. Do not only air the interior, but also the storage spaces which are accessible from the outside. Air the parking place as well if the vehicle is parked in a closed space (e.g. garage). The occurrence of condensation could lead to the formation of mould.

7.10 Windows



- ▷ The windows are fitted with a blind or Roman shade and with an insect screen or folding insect screen. After the latch has been released, the blind and insect screen automatically spring back to the initial position by tensile force. In order not to damage the tension mechanics, hold onto the blind or insect screen and allow it to slowly return to the initial position. The Roman shade and folding insect screen are made of thin woven fabric. In order not to damage the Roman shade or the insect screen, grasp the respective handle and carefully return it to the initial position.
- ▷ Do not keep blinds closed over a longer period of time as that can cause increased material wear.
- ▷ If the blind or the Roman shade is completely closed, exposure to direct sunlight can cause heat to accumulate between the blind/the Roman shade and the window. The window could be damaged. Therefore, if the shade is installed in the bottom blind box, close the shade only 2/3 when sunlight is intense. This allows the heat to escape between the window and the shade. If the shade is installed in the top blind box, close the shade fully and open it regularly. Also move the window into the "continuous ventilation" position.
- ▷ Before commencing the journey, close the windows.
- ▷ Depending on the weather, close the windows far enough to prevent moisture from entering.
- ▷ To open and close the window, open or close all catch levers which are fitted to the window.



- ▷ When leaving the vehicle, always close the windows.
- ▷ In extreme weather conditions or if the temperature fluctuates strongly, a light condensation film can form on the double-glazed acrylic glass. The glass is designed in such a way that condensation can evaporate when the external temperature increases. There is no danger of the double-glazed acrylic glass being damaged by condensation.

7.10.1 Hinged window



- ▷ If windows with automatic hinges are fitted, open the window fully in order to release the lock. If the locking device is not released and the window is closed nevertheless, there is the danger of the window breaking due to the massive counter-pressure.
- ▷ When opening the hinged windows, ensure that there are no torsional forces. Open and close the hinged windows evenly.
- ▷ If the catch lever is equipped with a safety knob, press the safety knob when operating the catch lever.

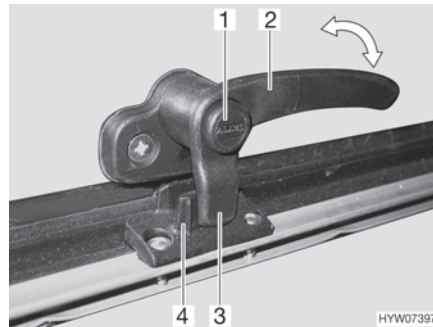

Fig. 67 Catch lever with safety knob in "closed" position

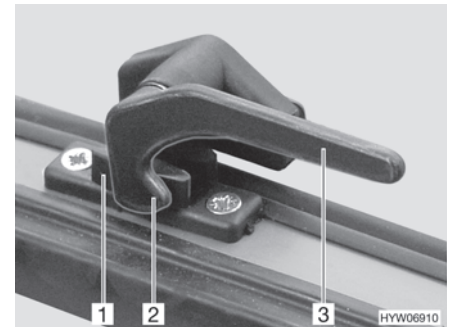

Fig. 68 Catch lever in "closed" position

Opening:

- Press and hold the security button (Fig. 67,1), if present.
- Turn the catch lever (Fig. 67,2 or Fig. 68,3) a quarter turn towards the centre of the window.

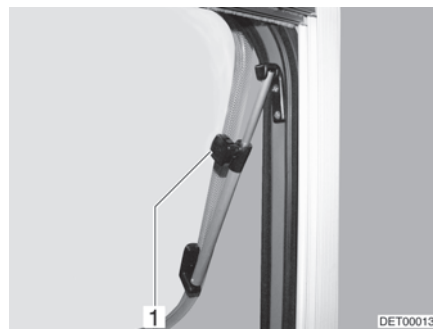

Fig. 69 Hinged window with rotary hinge



Fig. 70 Hinged window with automatic hinge

- Hinged window with rotary hinge: Open the hinged window until the required position has been reached and use knurled knob (Fig. 69,1) to secure in position.
Hinged window with automatic hinge: Open the hinged window to the desired latched position. The automatic hinge (Fig. 70,1) locks in place automatically.

The hinged window remains locked in the required position.

- Closing:
- Hinged window with rotary hinge: Turn knurled knob (Fig. 69,1) until the latch is released.
Hinged window with automatic hinge: Open the hinged window as wide as is necessary to release the lock.
 - Close the hinged window.
 - Press and hold the security button (Fig. 67,1), if present.
 - Turn the catch lever (Fig. 67,2 or Fig. 68,3) a quarter turn towards the window frame. The locking catch (Fig. 67,3 or Fig. 68,2) on the catch lever is entirely on the inner side of the window catch (Fig. 67,4 or Fig. 68,1).

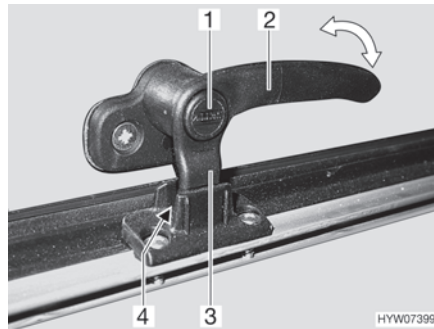

Fig. 71 Catch lever with safety knob in "continuous ventilation" position

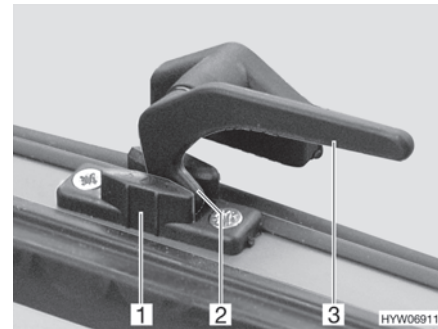

Fig. 72 Catch lever in "continuous ventilation" position

Continuous ventilation

With the catch lever, the hinged window can be placed in two positions:

- "Continuous ventilation" (Fig. 71 and Fig. 72)
- "Firmly closed" (Fig. 67 and Fig. 68)

To place the hinged window into the "continuous ventilation" position:

- Press and hold the security button (Fig. 71,1), if present.
- Turn the catch lever (Fig. 71,2 or Fig. 72,3) a quarter turn towards the centre of the window.
- Slightly open the hinged window outwards.
- Return the catch lever to its initial position. Move the locking catch (Fig. 71,3 or Fig. 72,2) on the catch lever into the recess of the window catch (Fig. 71,4 or Fig. 72,1).
- Press and hold the security button (Fig. 71,1), if present.
- Make certain that the safety knob is not pushed in but rather that it secures the catch lever.

During the journey, the hinged window may not be in "continuous ventilation" position.

If it rains, the "continuous ventilation" hinged window position could lead to splashing water penetrating the living area. Therefore, close the hinged windows completely.

7.10.2 Blind and insect screen



- ▷ Open blinds before commencing the journey. When the blinds are closed, vibrations can damage the spring shaft.



- ▷ Depending on the window size, the blinds are fitted with one or two handles.

The windows are fitted with a blind and an insect screen. The blind and insect screen are adjusted separately.

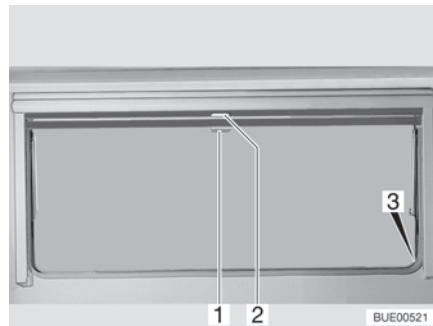

Fig. 73 Hinged window

Blind The blind is located in the upper blind box.

- Closing:**
- Pull blind at the handle (Fig. 73,2) downwards. If the blind is to be completely closed, it is suspended into the locking devices (Fig. 73,3) situated on both sides of the window frame.
- Opening:**
- If the blind is completely closed: Press handle (Fig. 73,2) downwards and, at the same time, tilt it slightly inward. The blind can be taken out of the locking devices situated on both sides of the window frame.
 - If the blind is in an intermediate position: Pull the handle (Fig. 73,2) slightly downwards until the locking device releases.
 - Use handle to return blind slowly to its initial position.

Insect screen The insect screen is located in the upper blind box.

- Closing:**
- Pull insect screen at the handle (Fig. 73,1) down and hang it into the locking devices (Fig. 73,3) situated on both sides of the window frame.
- Opening:**
- Press handle (Fig. 73,1) downwards and, at the same time, tilt it slightly inward. The insect screen can be taken out of the locking devices situated on both sides of the window frame.
 - Use handle to return the insect screen slowly to its initial position.

7.10.3 Roman shade and insect screen

The windows are fitted with a Roman shade and an insect screen. The insect screen can only be moved together with the Roman shade.

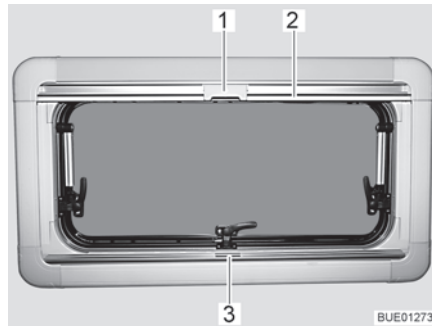

Fig. 74 Hinged window

Roman shade The Roman shade is located in the bottom blind box.

Closing: ■ Grip the Roman shade in the centre of the holding bar (Fig. 74,3), pull it from the bottom to the top and then release it at the desired height. The Roman shade will stay at this height.

Opening: ■ Grip the Roman shade in the centre of the holding bar and push it down.

Insect screen The insect screen is located in the upper blind box.

Closing: ■ Pull the insect screen down using the holding bar (Fig. 74,2), until it touches the holding bar of the Roman shade (Fig. 74,3).
 ■ Clip the catch (Fig. 74,1) on the insect screen into the handle of the Roman shade.

Opening: ■ Push the catch (Fig. 74,1) on the insect screen inwards.
 ■ Move the insect screen back slowly on the holding bar (Fig. 74,2).

7.10.4 Roman shades for windscreen, driver's window and front passenger's window

Depending on the model, the driver's cabin is shaded either with pleated shades or with Remis Roman shades (special equipment).

Pleated shades

The pleated shades are standard equipment on the vehicle.



Fig. 75 Pleated shades on passenger window



Fig. 76 Fixing of pleated shades

The pleated shades (Fig. 75,2) are fixed with snap fasteners (Fig. 75,1 and Fig. 76,1).

Remis Roman shades (special equipment)

The Roman shades are fixed with magnetic strips and are permanently fitted to the vehicle inside the frame.

Proceed as described below to open or close permanently installed Roman shades.

Windscreen



Fig. 77 Roman shade for the windscreen

Shading:

- Press the release handles (Fig. 77,1) and hold them down.
- Use the handle (Fig. 77,2) to pull the Roman shade for the windscreen towards the centre of the window.
- Close the second Roman shade for the windscreen in the same way. A magnetic catch holds both parts of the Roman shade together in the centre.

- Opening the Roman shade:
- Press the release handles (Fig. 77,1) and hold them down.
 - Use the handle (Fig. 77,2) to pull the two halves of the Roman shade for the windscreen outwards as far as they will go. As you do so, lift the handle up as high as the locking recess.
 - Let go of the release handles (Fig. 77,1) and let them engage.

Driver's window and front passenger's window

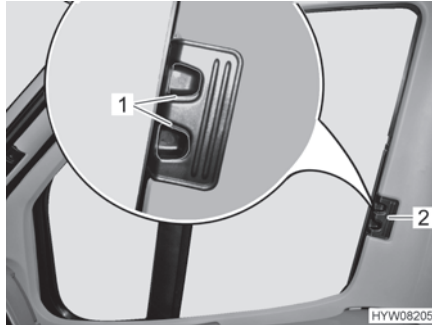

Fig. 78 Roman shade for driver's and passenger's window

- Shading:
- Press the release handles (Fig. 78,1) and hold them down.
 - Using the handle (Fig. 78,2), draw the Roman shades for the driver's and passenger's window to the other side of the window and secure them to the magnetic strips.

- Opening the Roman shade:
- Press the release handles (Fig. 78,1) and hold them down.
 - Use handle (Fig. 78,2) to push in the Roman shades for the driver's and passenger's window as far as possible.
 - Let go of the release handles (Fig. 78,1) and let them engage.

7.11 Skylights

Depending on the model, skylights with or without forced ventilation are fitted to the vehicle. If a skylight is fitted without forced ventilation, the forced ventilation is performed using mushroom-shaped vents.



- ▶ The apertures for forced ventilation must always be kept open. Never cover or block forced ventilations with objects such as e.g. a winter mat. Keep forced ventilations clear of snow and leaves.



- ▷ The skylights are fitted with a blind or Roman shade and with an insect screen or folding insect screen. After the latch has been released, the blind and insect screen automatically spring back to the initial position by tensile force. In order not to damage the tension mechanics, hold onto the blind or insect screen and allow it to slowly return to the initial position. The Roman shade and folding insect screen are made of thin woven fabric. In order not to damage the Roman shade or the insect screen, grasp the respective handle and carefully return it to the initial position.
- ▷ Do not keep blinds closed over a longer period of time as that can cause increased material wear.



- ▷ If the blind or the Roman shade is completely closed, exposure to direct sunlight can cause heat to accumulate between the blind/the Roman shade and the skylight. The skylight could be damaged. For that reason, close the blind/Roman shade only 2/3 of the way in direct sunlight. Open the skylight slightly or move it to ventilation position.
- ▷ Depending on the weather, close the skylights far enough to prevent moisture from entering.
- ▷ Do not climb on the skylights.
- ▷ Before commencing the journey, close the skylights.
- ▷ Before commencing the journey, check that the skylights are closed and locked.



- ▷ When leaving the vehicle, always close the skylights.

7.11.1 Heki skylight (mini and midi) (partially special equipment)

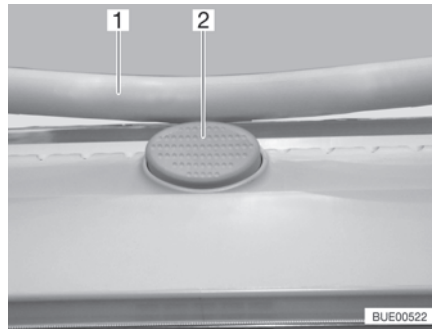

Fig. 79 Safety knob on the Heki skylight

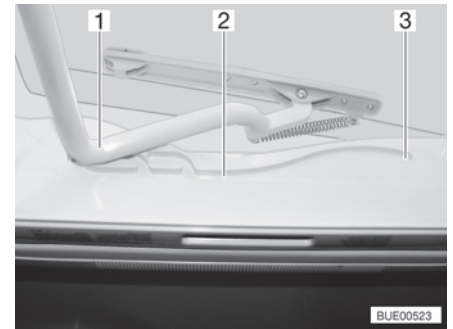

Fig. 80 Heki skylight, guide

The Heki skylight is opened on one side only.

- Opening:**
- Press the safety knob (Fig. 79,2) and pull the bar (Fig. 79,1) down with both hands.
 - Pull the bar (Fig. 80,1) in the guides (Fig. 80,2) to the rearmost position (Fig. 80,3).
- Closing:**
- Use both hands to push the bar (Fig. 80,1) slightly upwards.
 - Push the bar back in the guides.
 - Push the bar upwards with both hands until it is above the safety knob (Fig. 79,2).

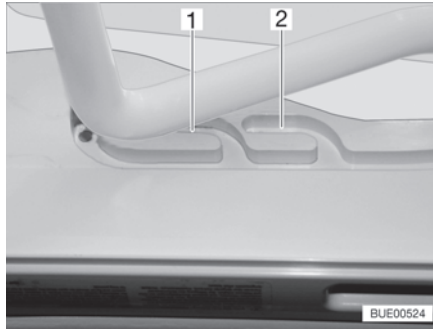

Fig. 81 Heki skylight in ventilation position

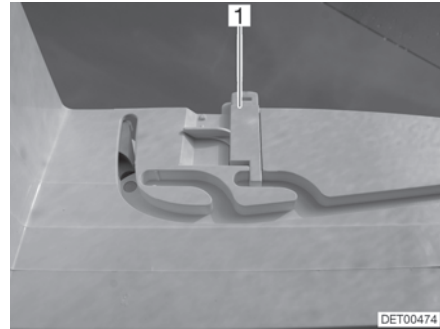

Fig. 82 Ventilation position locking mechanism

Ventilation position

The Heki skylight can be put in two ventilation positions: Bad weather position (Fig. 81,1) and central position (Fig. 81,2). Depending on the model, the skylight can be locked in the central position with both left and right latches (Fig. 82,1) on the skylight frame.

- Press the safety knob (Fig. 79,2) and pull the bar (Fig. 79,1) down with both hands.
- Pull the bar in the guides (Fig. 80,2) to the desired position.
- Push the bar slightly upwards and into the selected guide (Fig. 81,1 or 2) and lock if necessary.

Roman shade

To close and open the Roman shade:

- Closing:**
- Pull out Roman shade at the handle and release in the required position. The Roman shade will stay in that position.
- Opening:**
- Slowly push the Roman shade at the handle to its initial position.

Insect screen

To close and open the insect screen:

- Closing:**
- Pull the insect screen by the handle to the opposite handle of the Roman shade.
- Opening:**
- Press the rear part of the handle of the insect screen. The latch is released.
 - Use handle to return the insect screen slowly to its initial position.

7.11.2 Wind-up skylight (partially special equipment)



Fig. 83 Wind-up skylight

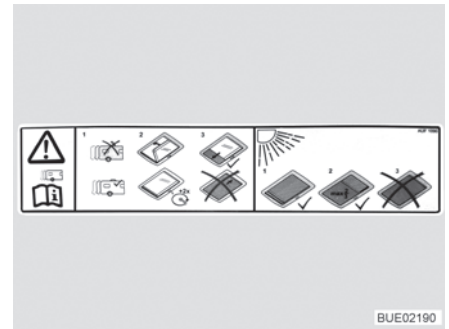

Fig. 84 Wind-up skylight warning notice

The wind-up skylight can be opened using the hand crank.

- Opening:**
- Rotate the hand crank (Fig. 83,2) until a resistance can be felt.
- Closing:**
- Rotate the hand crank until the wind-up skylight is closed. The wind-up skylight can be locked after rotating two or three more times.
 - Check the locking mechanism. To do so, press your hand against the acrylic glass.

Roman shade The Roman shade can be closed in any position, as desired. If the Roman shade is locked with the insect screen, the insect screen is also moved along on closing the Roman shade.

- Closing:**
- Pull the handle of the Roman shade (Fig. 83,3) and release in the desired position. The Roman shade will stay in that position.
- Opening:**
- Slowly push the Roman shade at the handle to its initial position.

Insect screen If the insect screen is locked with the Roman shade, the Roman shade is also moved along on closing the insect screen.

- Closing:**
- Pull insect screen at the handle (Fig. 83,1) to the opposite handle of the Roman shade (Fig. 83,3) and allow to engage.
- Opening:**
- Press the handle of the insect screen (Fig. 83,1) at the back upwards and detach the insect screen from the Roman shade (Fig. 83,3).
 - Slowly push insect screen at the handle to its initial position.

7.11.3 Omni-Vent skylight with fan (special equipment)



- ▷ To save the battery, after one hour the fan automatically switches from level 6 down to level 1.

The skylight is equipped with an insect screen, blind and an adjustable fan for ventilation.

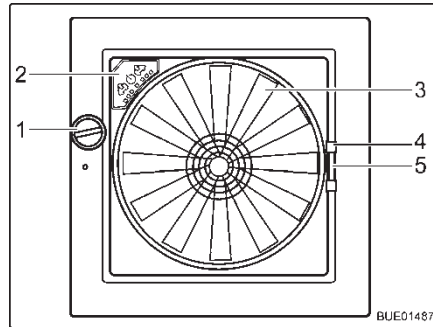

Fig. 85 Omni-Vent skylight

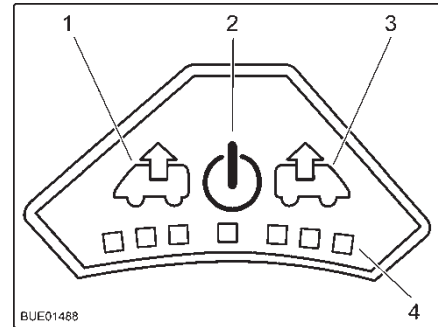

Fig. 86 Control panel for fan

Opening: ■ Turn the knob (Fig. 85,1) until the desired opening angle is reached.

Closing: ■ Turn the knob (Fig. 85,1) until the skylight is fully closed.

Insect screen To close and open the insect screen:

Closing: ■ Using the handle (Fig. 85,4) pull the insect screen across to the other side of the frame.

Opening: ■ Press the handle of the insect screen together. The latch is released.
■ Use handle to return the insect screen slowly to its initial position.

Shade To close and open the shade:

Closing: ■ Press together the handle (Fig. 85,5) of the shade.
■ Pull out the shade to the desired position and release. The shade will stay in that position.

Opening: ■ Press together the handle of the shade.
■ Slowly return the shade to its initial position.

Fan If the skylight is open, the interior can be vented and aerated with the 6-speed fan (Fig. 85,3). The fan is operated via the operating panel (Fig. 85,2).

Switching on: ■ Press the On/Off button (Fig. 86,2). The fan runs in comfort mode (venting at slowest fan speed).

Venting: ■ To increase the fan speed: Press the Vent button (Fig. 86,1). The fan speed in the venting direction increases by one level. LEDs (Fig. 86,4) show the operating levels.
■ To lower the fan speed: Press the Aerate button (Fig. 86,3). The fan speed decreases by one level.

- Aerating:**
- To increase the fan speed: Press the Aerate button (Fig. 86,3). The fan speed in the aerating direction increases by one step. LEDs (Fig. 86,4) show the operating levels.
 - To lower the fan speed: Press the Vent button (Fig. 86,1). The fan speed decreases by one level.
- Boost function:**
- Press and hold the Aerate button for approx. 3 seconds. The fan switches to the maximum aeration level and then, after approximately 5 minutes, automatically switches back to the previously selected level.
 - Press and hold the Vent button for approx. 3 seconds. The fan switches to the maximum venting level and then, after approximately 5 minutes, automatically switches back to the previously selected level.
- Switching off:**
- Press the On/Off button (Fig. 86,2). The fan stops, the LEDs go out.

7.11.4 Skyroof skylight



- ▷ When opening the skylight, ensure that there are no torsional forces. Open and close the skylight evenly.
- ▷ If the catch lever is equipped with a safety knob, press the safety knob when operating the catch lever.

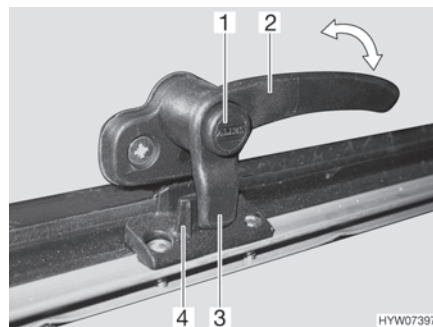

Fig. 87 Catch lever with safety knob in "closed" position

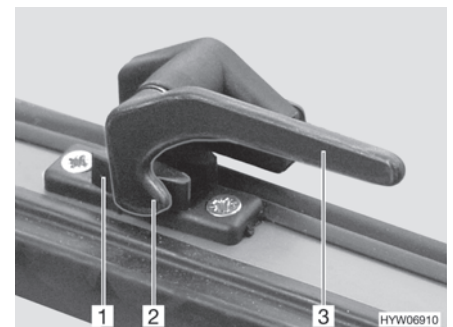

Fig. 88 Catch lever in "closed" position

- Opening:**
- Press and hold the security button (Fig. 87,1), if present.
 - Turn all catch levers (Fig. 87,2 or Fig. 88,3) a quarter turn towards the centre of the skylight.
 - Press and hold the security button, if present.

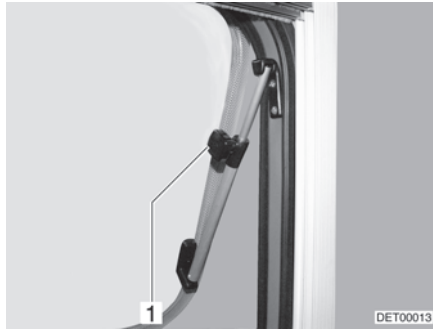

Fig. 89 Skylight with rotary hinges, open

- Open the skylight until the required position has been reached and use knurled knob (Fig. 89,1) to secure in position.

The skylight remains locked in the desired position.

- Closing:**
- Turn knurled knob (Fig. 89,1) until the latch is released.
 - Close the skylight.
 - Press and hold the security button (Fig. 87,1), if present.
 - Turn all catch levers (Fig. 87,2 or Fig. 88,3) a quarter turn towards the frame. The locking catch (Fig. 87,3 or Fig. 88,2) is located on the inside of the skylight lock (Fig. 87,4 or Fig. 88,1).
 - Press and hold the security button, if present.

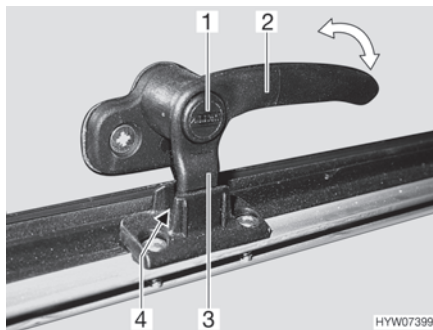

Fig. 90 Catch lever with safety knob in "continuous ventilation" position

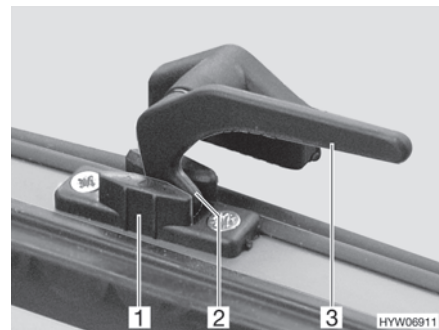

Fig. 91 Catch lever in "continuous ventilation" position

Continuous ventilation

With the catch levers, the skylight can be placed in 2 different positions:

- "Continuous ventilation" (Fig. 90 and Fig. 91)
- "Firmly closed" (Fig. 87 and Fig. 88)

To place the skylight into the "continuous ventilation" position:

- Press and hold the security button (Fig. 90,1), if present.
- Turn all catch levers (Fig. 90,2 or Fig. 91,3) a quarter turn towards the centre of the skylight.
- Slightly push the skylight outwards.
- Return all catch levers to their initial position. The locking catch (Fig. 90,3 or Fig. 91,2) has to be moved into the recess of the skylight lock (Fig. 90,4 or Fig. 91,1).
- Press and hold the security button, if present.

During the journey, the skylight may not be in the "continuous ventilation" position.

If it rains, the "continuous ventilation" skylight position could lead to splashing water penetrating the living area. Therefore, close the skylight completely.



- ▷ If the Roman shade is completely closed, heat can accumulate between the Roman shade and the glass windows when exposed to direct sunlight. The skylight could be damaged. For that reason, close the Roman shade only 2/3 of the way in direct sunlight. Open the skylight slightly or move it to ventilation position.



Fig. 92 Skyroof skylight

Roman shade The Roman shade is fitted in the frame, at the bottom.

- Closing:**
- Hold the Roman shade in the centre of the bottom rod and carefully draw it upwards.
 - Release the Roman shade at the desired position. The Roman shade will stay in that position.
- Opening:**
- Carefully return the bottom rod of the Roman shade downwards to the limit stop on the frame.

Insect screen The insect screen is fitted in the frame, at the top.

- Closing:**
- Hold the insect screen in the centre of the bottom rod and carefully pull it down.
 - Continuous adjustment of the insect screen may be made by moving the bottom rod.
- Opening:**
- Carefully return the bottom rod of the insect screen upwards to the limit stop on the frame.

7.12 Suspension table

Table leg The table leg can be set up at two different heights:

- Normal table height
- Decreased table height (when converting to a bed foundation)

To lower the table, there are the following possibilities (depending on model):

- Replacing the long table leg with a short one
- Folding in one part of the table leg
- Removing one part of the table leg

Table-top Depending on the model, the table-top can be extended.

Swing-out table extension The table surface can be expanded by swinging out the table extension.



Fig. 93 Swing-out table extension

Expanding the table:

- Pull the knob (Fig. 93,3) of the lock down and swing out the table extension (Fig. 93,2).

Reducing the table size:

- Swing the table extension (Fig. 93,2) under the table-top (Fig. 93,1) until the lock latches in place audibly.

Insertable table extension The suspension table size can be enlarged by inserting a table extension.

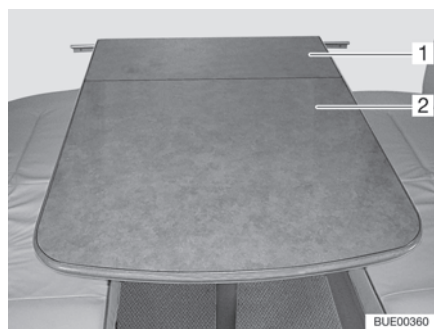

Fig. 94 Insertable table extension

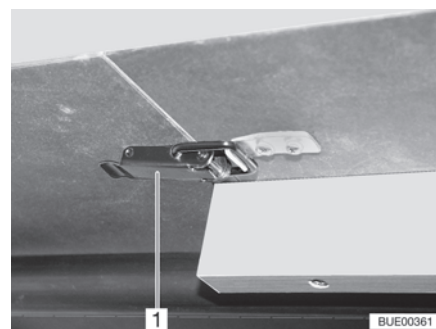

Fig. 95 Catch

Expanding the table:

- Open catches (Fig. 95,1).
- Raise the table-top (Fig. 94,2) slightly and pull it out as far as possible.
- Set down the table.
- Insert the table extension (Fig. 94,1) and secure it with the catch (Fig. 95,1).
- Lift the table-top slightly and push back as far as possible.
- Secure the table-top with the catches.

Reducing the table size:

- Open catches (Fig. 95,1).
- Slightly lift the front of the table-top and pull out.
- Remove table extension (Fig. 94,1) and lay it aside.
- Lift the table-top slightly and push back as far as possible.
- Set down the table.
- Secure the table-top with the catches.



- ▷ The extension frame beneath the table-top is locked into the mounting rail. Release the lock before lifting the table-top.

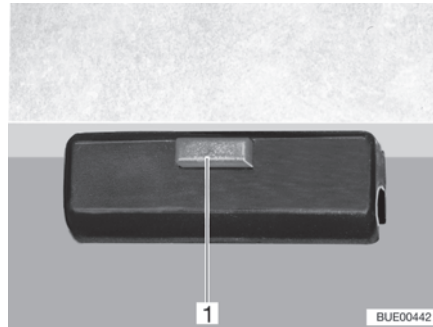

Fig. 96 Lock

Conversion to bed foundation:

- Lift the front of the table-top by approx. 45°.
- Depending on the model, shorten the table leg to the conversion level.
- Release the lock (Fig. 96,1) on the table top.
- Take the table-top out of the upper retainer.
- Hook the table-top at a 45° angle to the supports into the lower retainer and place on the floor with the shortened table leg.
- Lock the table-top.

7.13 Divan adjustment mechanism



- ▷ To avoid increased wear and tear of the cushion, push both sides of the seat cushion slightly inwards when folding the neck cushion downwards.

The "Reliner[®]" divan allows you to adjust the seat and fold the neck cushion down along the length of the seat. When the neck cushion is folded down along the divan, the divan can be used as a comfortable sleeping area or as an extra bed.

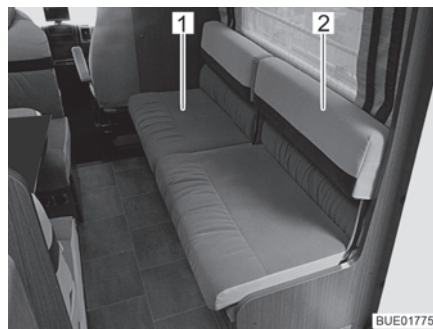

Fig. 97 Adjusting the seat

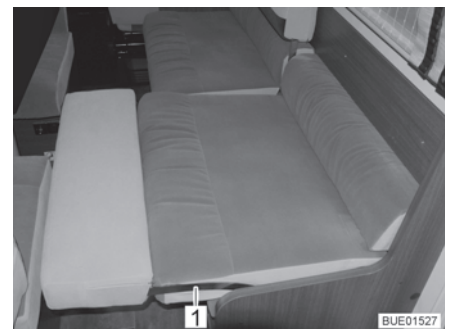

Fig. 98 Adjusting the neck cushion

Adjusting the seat:

- Slightly lift the seat (Fig. 97,1).
- Pull seat forward to the desired position and lower it.

- Adjusting the neck cushion:
- Hold the neck cushion (Fig. 97,2) and carefully fold it downwards.
 - Push the seat cushion slightly inwards in the area around the metal clip (Fig. 98,1).

7.14 Additional seat

Using a folding bench seat enlargement on the front bench, it is possible to create an additional seat or a comfortable lying surface.

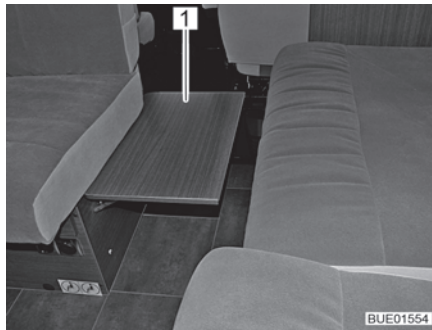

Fig. 99 Folding bench seat enlargement

- Using the additional seat:
- Fold up the bench seat enlargement (Fig. 99,1) on the front bench and lock into place.
 - Place the supplied seat cushion on the bench seat enlargement.
 - If required, move the Reliner[®] seat far enough forwards to create a continuous cushioned surface.
- Removing the additional seat:
- Remove the seat cushion from the bench seat enlargement and store it securely.
 - Release bench seat enlargement on the front bench on both sides at the same time and swing it downward.

7.15 Beds



- ▶ Always use the safety guards supplied.
- ▶ Never remove or dismantle the safety guards supplied.

7.15.1 Overcab bed



- ▶ The maximum permitted overcab bed load is 200 kg.
- ▶ Only use the overcab bed, if the safety net is set up.
- ▶ Never allow small children to remain in the overcab bed without supervision.
- ▶ But in particular with regard to small children less than 6 years of age, users should ensure that they cannot fall out of the overcab bed.
- ▶ Use separate children's beds or travel cots suitable for children.



- ▷ Do not load the overcab bed without mattress. The plastic mould part can break!

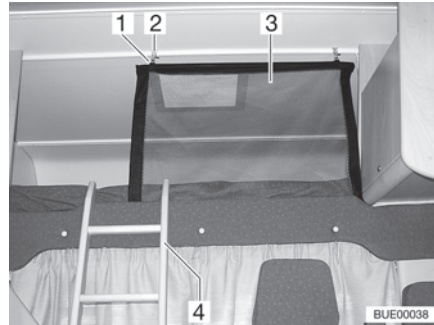

Fig. 100 Overcab bed

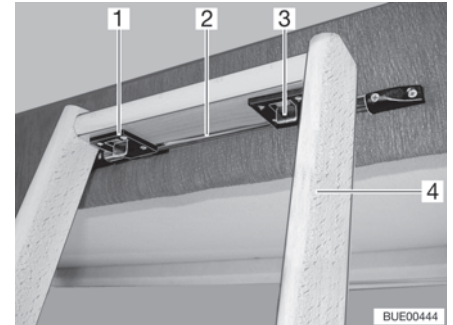

Fig. 101 Access ladder, catch

Access ladder

Always use the access ladder (Fig. 100,4 and Fig. 101,4) provided as standard to access the overcab bed.

Attaching:

- Hang the ladder with the two hooks (Fig. 101,1) on the rail (Fig. 101,2) of the alcove flap.
- Push the two catches (Fig. 101,3) forward.

Safety net

The safety net (Fig. 100,3) is stored as standard between the mattress and slatted frame. Only use the safety net if persons are already in the alcove.

Setting up:

- Attach the holder (Fig. 100,1) to the eyes on the ceiling (Fig. 100,2).

Folding mechanism

The overcab bed can be folded up. This simplifies passage from driver's cabin to living area.

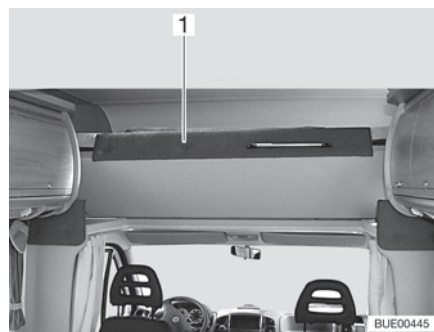

Fig. 102 Overcab bed, folded upwards

Folding upwards:

- If necessary, open the driver's cabin partition.
- Tip mattress backwards.
- Fold the front of the overcab bed (Fig. 102,1) upwards. The overcab bed is kept in the upper position by gas-pressure springs.

Folding downwards:

- Pull overcab bed downwards.
- Tip mattress forwards.

7.15.2 Fixed bed (adjustable head section)



▶ Do not let the slatted frame fall down when closing the bed!

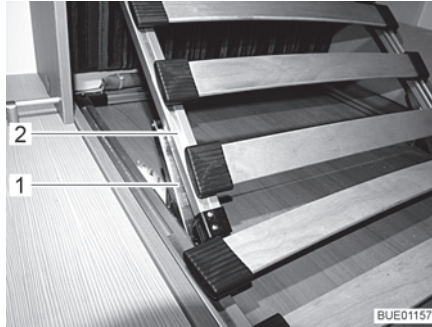

Fig. 103 Adjustable head section

Depending on the configuration, the head section of the slatted frame can be adjusted in several stages.

Raising the head section:

- Raise the head section (Fig. 103,2) of the slatted frame to the desired position. The support (Fig. 103,1) locks automatically into place.

The head section remains locked in the required position.

Lowering the head section:

- Raise the head section (Fig. 103,2) of the slatted frame until the lock is released.
- Guide the head section downwards slowly.

7.16 Converting seating groups for sleeping

7.16.1 Central seating group

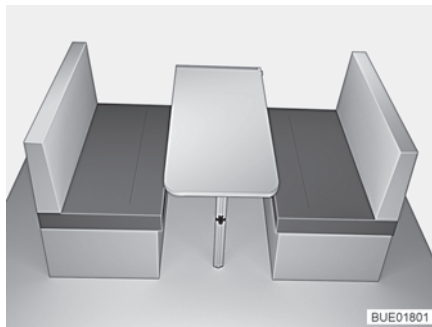

Fig. 104 Prior to conversion

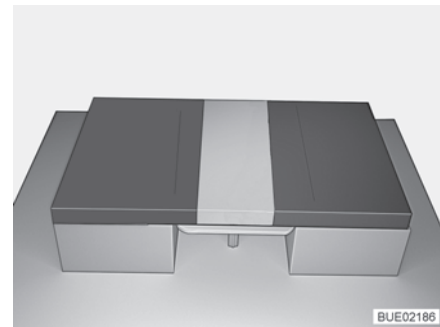

Fig. 105 After conversion

- Convert the table to a bed foundation (see section 7.12).
- Remove the back cushions.
- Insert a back cushion between the seat cushions on the table (see Fig. 105).

7.17 Shower connection point for external shower (special equipment)



- ▶ Only use the external shower if there is a gap of at least 1.20 m between the shower and the nearest electrical device or connection. Risk of electric shock!



- ▷ If decommissioned for a longer time or if there is a risk of frost, drain the water system.

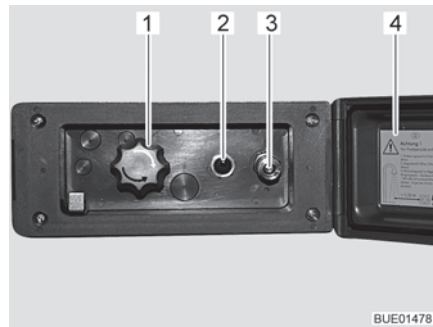

Fig. 106 External shower connection point

Connecting an external shower:

- Unlock and open the cover (Fig. 106,4).
- Attach hose of the external shower to the quick closure (Fig. 106,3).

Using the shower:

- Switch on the water pump using the switch (Fig. 106,2).
- Adjust the water temperature with the rotary knob (Fig. 106,1) as desired.
- Switch off the water pump using the switch (Fig. 106,2).

Shutting off the shower connection point:

- Switch off the water pump using the switch (Fig. 106,2).
- Disconnect the hose from the quick closure. The quick closure is equipped with a check valve to prevent any further water from escaping.
- Close the cover (Fig. 106,4) and lock with key.

Emptying:

- Attach hose of external shower to quick closure. The check valve is opened and the connections can run dry.
- Turn knob (Fig. 106,1) to the centre position.
- Empty the water system (see section 11.2.8).

Chapter overview

This chapter contains instructions regarding the gas system of the vehicle. The operation of the gas operation appliances of the vehicle is described in chapter 10.

8.1 General



- ▶ The operator of the gas system is responsible for the performance of recurring inspections and for complying with the maintenance intervals.
- ▶ Before commencing the journey, when leaving the vehicle or when gas equipment is not in use, close all gas isolator taps and the main isolator tap on the gas bottle.
- ▶ All gas-operated devices (heater, cooker, oven, grill, refrigerator - depending on the equipment) must be switched off for refuelling, on ferries or in the garage. Danger of explosion!
- ▶ Do not use gas-operated devices in closed spaces (e.g. garages). Danger of poisoning and suffocation!
- ▶ Only have the gas system maintained, repaired or altered by an authorised specialist workshop.
- ▶ Have the gas system checked by an authorised specialist workshop according to the national regulations before commissioning. This also applies for not registered vehicles. For modifications to the gas system have the gas system immediately checked by an authorised specialist workshop.
- ▶ The gas pressure regulator, the gas tubes, and the exhaust gas pipes must also be inspected. The gas pressure regulator and the gas tubes must be replaced observing the nationally defined deadlines (the latest after 10 years). The vehicle owner is responsible for seeing that this is carried out.
- ▶ In case of a defect of the gas system (gas odour, high gas consumption) there is danger of explosion! Close regulator tap on the gas bottle immediately. Open doors and windows and ventilate well.
- ▶ If the gas system is defective: Do not smoke; do not ignite any open flames, and do not operate electric switches (light switches etc.). Check the tightness of gas-conducting parts and lines with leakage search spray. Do not check with an open flame.
- ▶ Only the stipulated devices may be connected to internal connections. Do not operate any device outside the vehicle if it is connected to an internal connector.
- ▶ Cooking is prohibited during the journey.
- ▶ Before using the cooker make sure that there is sufficient ventilation. Open a window or the skylight.
- ▶ Do not use gas-operated cooking and baking facilities for heating purposes.



- ▶ If there are several gas devices, each gas device must have its own gas isolator tap. If individual gas devices are not in use, close the respective gas isolator tap.
- ▶ Ignition safety valves must close within 1 minute after the gas flame has extinguished. A clicking sound is audible. Check function from time to time.
- ▶ The built-in gas devices are exclusively meant for use with propane or butane gas or a mixture of both. The gas pressure regulator as well as all built-in gas devices are designed for a gas pressure of 30 mbar.
- ▶ Propane gas is capable of gasification up to -42 °C, whereas butane gas gasifies at 0 °C. Below these temperatures no gas pressure is available. Butane gas is unsuitable for use in winter.
- ▶ Due to its function and construction, the gas bottle compartment is a space which is open to the exterior. Never cover or block up the standard forced ventilations. Otherwise gas that is emitted can not be diverted to the outside.
- ▶ The gas bottle compartment must not be used as storage space.
- ▶ Secure the gas bottle compartment against unauthorised access. To do this, lock the compartment.
- ▶ The regulator tap on the gas bottle must be accessible.
- ▶ Only connect gas-operated devices which have been designed for a gas pressure of 30 mbar.
- ▶ The exhaust gas pipe must be fitted tightly to the heating system and to the vent and must be sealed. The exhaust gas pipe must not show any evidence of damage.
- ▶ Exhaust fumes must be able to escape into the atmosphere unhindered and fresh air must be able to enter unhindered. For this reason, keep the exhaust pipe and intake openings clean and unobstructed (e.g. free from snow and ice). For this reason, no snow walls or aprons may lie against the vehicle.

8.2 Gas bottles



- ▶ Handle full or emptied gas bottles outside the vehicle only with closed regulator tap and attached protective cap.
- ▶ Gas bottles are only to be transported within the designated gas bottle compartment.
- ▶ Place the gas bottles in vertical position in the gas bottle compartment.
- ▶ Fasten the gas bottles so that they are unable to turn or tilt.
- ▶ Connect the gas tube to the gas bottle without tension.
- ▶ If the gas bottles are not connected to the gas tube, always place the protective cap on top.
- ▶ Close the regulator tap on the gas bottle before the gas pressure regulator or gas tube are removed from the gas bottle.
- ▶ Depending on the connection, unscrew the gas tube from the gas bottle and screw it on the gas bottle again by hand or using a suitable special spanner. The screw connection on the gas bottle generally has a left-hand thread. **Do not** tighten too firmly.
- ▶ Only use special gas pressure regulators with a safety valve designed for vehicle use. Other gas pressure regulators are not permitted and cannot meet the demanding requirements.
- ▶ Use only 11 kg or 5 kg gas bottles. Camping gas bottles with built-in check valve (blue bottle with max. 2.5 or 3 kg content) are can be used in exceptional cases with a safety valve.
- ▶ Use the shortest possible tube lengths (150 cm max.) for external gas bottles.
- ▶ Never block the floor ventilation openings below the gas bottles.



- ▷ With some models, the gas bottle compartment is located right next to the conversion door. With these models, only open the gas bottle compartment when the conversion door is closed. Danger from damages.



- ▷ The screw connections on the gas bottles generally have a left-hand thread.
- ▷ For gas-operated units the gas pressure must be reduced to 30 mbar.
- ▷ Connect gas pressure regulator complete with safety valve directly to bottle valve.
The gas pressure regulator reduces the gas pressure in the gas bottle down to the operating pressure of the gas devices.
- ▷ For filling and connecting the gas bottles in Europe the accessories shops have corresponding Euro filling sets and Euro bottle sets.
- ▷ Information available at the dealers or service centre.
- ▷ For information on the gas supply in Europe see chapter 18.

The gas pressure regulator is permanently installed in the gas bottle compartment. The gas bottle is connected to the gas pressure regulator via a high-pressure gas hose.

The high-pressure gas hoses and their connections are different in the various countries. The accessories shop offers the respective country-specific models and adapters.

8.3 Gas isolator taps

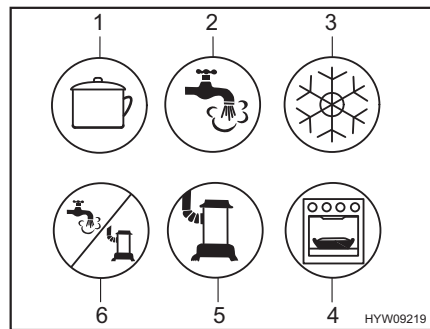

- 1 Cooker
- 2 Hot water
- 3 Refrigerator
- 4 Oven/grill
- 5 Heater
- 6 Hot water/heater

Fig. 107 Possible symbols for the gas isolator taps

A gas isolator tap (Fig. 107) for every gas device is built into the vehicle. The gas isolator taps are located in the vehicle at different positions, and can also be fitted separately. Generally, you will have access to the gas isolator taps in the kitchen unit opening a door or a drawer.

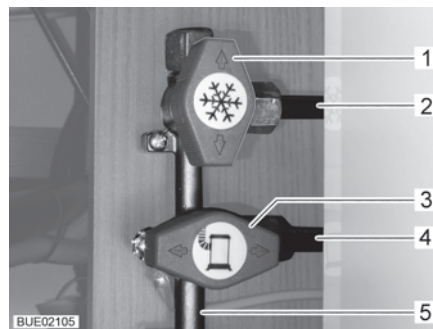

- 1 Gas isolator tap for refrigerator closed
- 2 Pipe to refrigerator
- 3 Heater gas isolator tap open
- 4 Pipe to heater
- 5 Gas pipe from gas bottle

Fig. 108 Gas isolator taps position (example)

- Opening:** ■ Position the gas isolator tap of the corresponding gas device parallel (Fig. 108,3) to the pipe (Fig. 108,4) leading to the gas device.
- Closing:** ■ Position the gas isolator tap of the corresponding gas device transverse (Fig. 108,1) to the pipe (Fig. 108,2) leading to the gas device.

8.4 External gas connection (special equipment)



- ▶ If the external gas connection is not in use, always close the gas isolator tap.
- ▶ Only gas appliances with a suitable adapter should be connected to the external gas connection.
- ▶ Connect only external gas appliances which are designed for an operation pressure of 30 mbar.
- ▶ Once you have made the connection and opened the gas isolator tap, make sure that no gas is escaping at the connection point. If there is a leak in the external gas connection, gas will escape into the open air. Immediately close the gas isolator tap and the regulator tap on the gas bottle. Have the external gas connection checked by an authorised specialist workshop.
- ▶ When connecting an external gas appliance, make sure that there is nothing near the external gas connection that could cause a spark.
- ▶ Only connect a gas appliance to the external gas connection. Do not use the external gas connection as supply (connection of an additional gas bottle).
- ▶ Do not use the external gas connection to fill gas bottles. Observe the information stickers on the external gas connection.

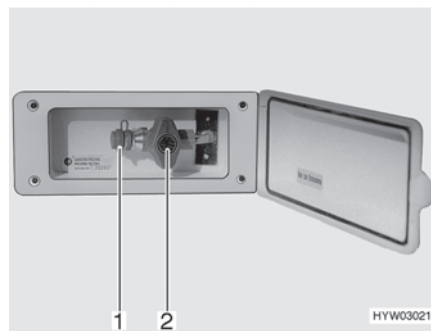

Fig. 109 External gas connection (gas isolator tap closed)

The external gas connection (Fig. 109) is located at the rear or to the left or right of the vehicle depending on the model.

- Connect the external gas device to the connection point (Fig. 109,1).
- Open the gas isolator tap (Fig. 109,2).

8.5 Gas bottle switching facility (special equipment)



- ▶ If the vehicle is equipped with a gas bottle switching facility without Crash Protection Unit (CPU), it is not permitted to operate gas devices during the journey. Close the regulator taps on the gas bottles and the gas isolator taps before setting off.



- ▷ When the vehicle is equipped with the crash protection unit the living area heater may be operated during the journey.
- ▷ The gas bottle switching facility and the hose lines shall be changed at the latest 10 years after manufacturing date. The operator is responsible for this.

The automatic switching facility automatically switches gas supply from the primary bottle to the reserve bottle as soon as the primary bottle is either empty or no longer ready for operation. The gas appliances may still continue operation. The switching facility is suitable for all commercial gas bottles from 3 kg to 33 kg.

Facility without Crash Protection Unit (CPU)

The gas bottle switching facility consists of a combined gas pressure regulator with reversing valve and indicator (Fig. 110,3). The gas bottle switching facility is installed between the two gas tubes (Fig. 110,1).

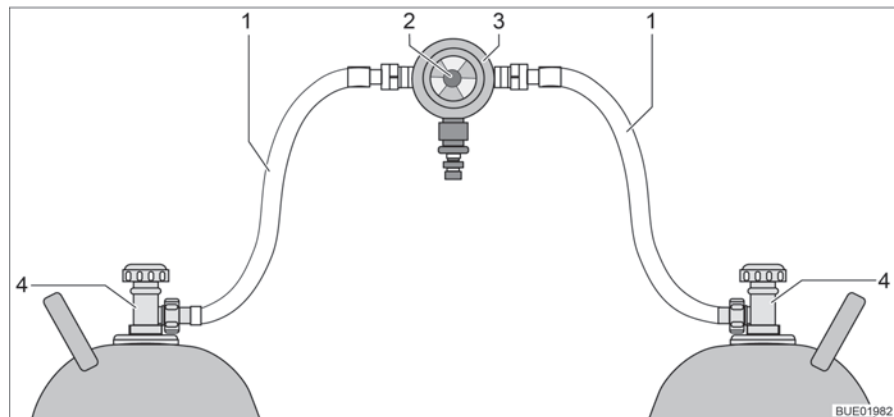

Fig. 110 Gas bottle switching facility

- 1 Gas tube
- 2 Knob for manual switching of the gas bottles
- 3 Gas pressure regulator with reversing valve and indicator
- 4 Regulator tap on the gas bottle

Facility with Crash Protection Unit (CPU)

The gas bottle switching facility consists of a combined gas pressure regulator with reversing valve and indicator (Fig. 111,4), and an electrovalve (Fig. 111,2). The electrovalve blocks the gas supply to the vehicle in the event of a full braking, an accident, or an unusually great inclined position. The gas bottle switching facility is installed between the two gas tubes (Fig. 111,1) with hose break guards (Fig. 111,5).

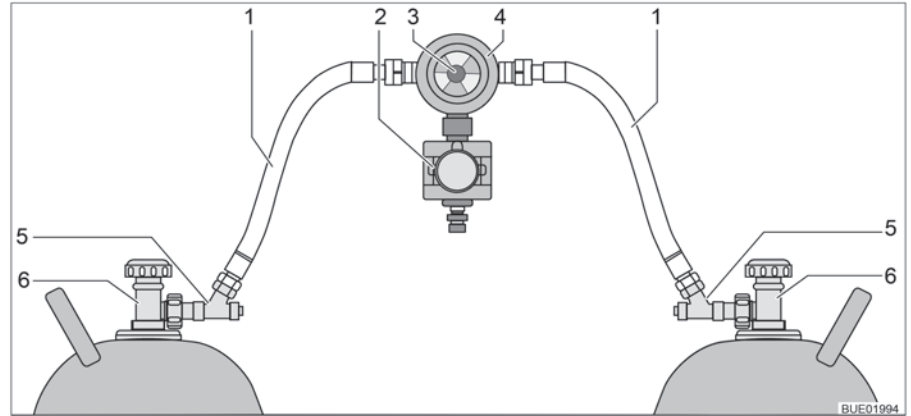

Fig. 111 Gas bottle switching facility with CPU

- 1 Gas tube
- 2 Electrovalve (CPU)
- 3 Knob for manual switching of the gas bottles
- 4 Gas pressure regulator with reversing valve and indicator
- 5 Hose break guard
- 6 Regulator tap on the gas bottle

Function

The gas bottle switching facility ensures a constant gas pressure, regardless of which gas bottle is being drawn upon. The display in the reversing valve shows the filling level of the primary bottle. When the display is green the primary bottle is full. When the display is red the primary bottle is empty. In this case, the reserve bottle is used for the gas supply.

Use the knob (Fig. 110,2 or Fig. 111,3) on the gas bottle switching facility to select which of the gas bottles is to be used as a primary bottle and which is to be used as a reserve bottle.

Operating unit

Depending on the equipment, the gas bottle switching facility is additionally equipped with an electrical operating unit (with or without remote display).



Fig. 112 Operating unit



Fig. 113 Operating unit with remote display

Only the electrical functions can be switched at the operating unit (Fig. 112). The regulator taps on the gas bottles (Fig. 110,4 or Fig. 111,6) must be opened and closed manually.

Without remote display The indicator lamp on the operating unit shows the condition of the gas system. The system is okay when the indicator lamp (Fig. 112,1) lights up green. When the indicator lamp lights up or flashes red a fault has occurred. The gas supply is interrupted.

With remote display The indicator lamp on the operating unit (Fig. 112,1) shows the condition of the gas system:

Indicator lamp	Signification
Off	System switched off, gas supply switched off
Green	System switched on, gas supply switched on
Red	Gas supply switched off, triggered by sloping position or excessive acceleration, e.g. in the event of an accident
Yellow	System switched on, gas supply switched on, primary bottle empty
Flashes yellow	Self-check, for approx. 2 seconds, after switching on
Flashes red once	Valve not connected to control unit or internal error
Flashes red twice	Overvoltage determined, gas supply interrupted
Flashes red three times	Undervoltage determined, gas supply interrupted

Putting into operation:

- Open the regulator taps of the gas bottles (Fig. 110,4 or Fig. 111,6).
- Press the hose break guards (Fig. 111,5) successively for 10 seconds.
- Use the knob (Fig. 110,2 or Fig. 111,3) on the switching facility to select the gas bottle which is to be the primary source of gas (primary bottle). Always turn the knob as far as it will go.
- Switch on the switching facility on the operating unit. For this, set the rocker switch (Fig. 112,2 or Fig. 113,2) to "ON". The reversing valve is now deaerated. The indicator lamp (Fig. 112,1 or Fig. 113,1) flashes yellow (system test) and lights up green.

Switching off:

- Set the rocker switch (Fig. 112,2 or Fig. 113,2) to "OFF". The indicator lamp (Fig. 112,1 or Fig. 113,1) goes out.
- Close the regulator taps of the gas bottles (Fig. 110,4 or Fig. 111,6).



- ▶ When changing gas bottles, do not smoke or create any open fire.
- ▶ Depending on the connection, unscrew the gas tube from the gas bottle and screw it on the gas bottle again by hand or using a suitable special spanner. The screw connection on the gas bottle generally has a left-hand thread. **Do not** tighten too firmly.

Changing gas bottles:

- Change the position of the knob of the switching facility. The display is green again. Should the display stay red the reserve bottle is also empty and has to be changed as well.
- Close regulator tap on the empty gas bottle.
- Unscrew the gas tube of the gas bottle.
- Attach the protective cap to the gas bottle.
- Release the fixing belts and remove the gas bottle.

- Place a new gas bottle in the gas bottle compartment.
- Fix gas bottle in place with the fixing belts.
- Remove the protective cap from the gas bottle.
- Connect the full gas bottle to the gas tube.
- Open the regulator tap on the gas bottle.
- Press the hose break guard for 10 seconds.
- Turn the knob on the reversing valve to the changed bottle. Open the release button when the display is green.
- Set the knob on the reversing valve with a half-turn, so that the newly replaced gas bottle will serve as a reserve bottle.

8.6 Changing gas bottles



- ▶ When changing gas bottles, do not smoke or create any open fire.
- ▶ Depending on the connection, unscrew the gas tube from the gas bottle and screw it on the gas bottle again by hand or using a suitable special spanner. The screw connection on the gas bottle generally has a left-hand thread. **Do not** tighten too firmly.
- ▶ When you have changed the gas bottle, check whether gas escapes at the connection points and unions. Use a leakage search spray to spray the relevant connection point or union. These agents are available at the accessories shop.

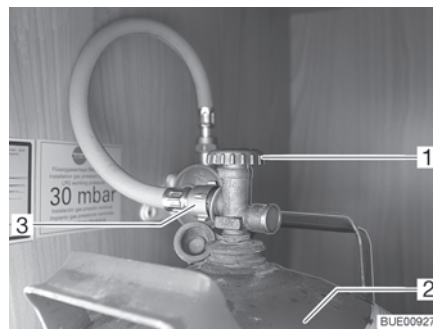

Fig. 114 Gas bottle compartment

- Open the external flap for the gas bottle compartment (see chapter 7).
- Close the regulator tap (Fig. 114,1) on the gas bottle (Fig. 114,2). Pay attention to the direction of the arrow.
- Unscrew the gas tube (Fig. 114,3) from the gas bottle.
- Attach the protective cap to the gas bottle.
- Release the fixing belts and remove the gas bottle.
- Place a filled gas bottle in the gas bottle compartment.
- Fix gas bottle in place with the fixing belts.
- Remove the protective cap from the gas bottle.
- Screw the gas tube onto the gas bottle.
- Close the external flap for the gas bottle compartment.

Chapter overview

This chapter contains instructions regarding the electrical system of the vehicle.

The operation of the electrical appliances of the housing body is described in chapter 10.

9.1 General safety instructions



- ▶ Only allow qualified personnel to work on the electrical system.
- ▶ All electronic devices (e.g. mobile telephones, radios, televisions or DVD players) which have been retrofitted to the vehicle and are operated during the journey must have certain features: These are the CE certification, the EMC inspection (electromagnetic compatibility) and the "e"-inspection.

Only in this way can the functional reliability of the vehicle be ensured. Otherwise the airbag may be triggered or interference to the on-board electronics may result.



- ▷ After the vehicle is started, delays to the output or forwarding of electrical impulses are possible.

The control unit of the basic vehicle does not release the D+ signal until the engine has reached full performance. In the event of a cold start in winter, this can take up to 15 seconds.

For this reason, output of warning signals (such as "entrance step extended") may sometimes be delayed.

The automatic retraction of a SAT antenna can also be delayed.

- ▷ During a storm, to protect the electrical devices disconnect the 230 V connection and retract the antennae.

9.2 Terms

Off-load voltage

The off-load voltage is the voltage of the battery in idle condition, i.e. no current is consumed and the battery is not being charged.



- ▷ The battery must remain idle for a while before measuring. After charging the last time, or after the last current has been drained by appliances, wait approximately 2 hours before measuring the off-load voltage.

Closed circuit current

Some electrical appliances, such as the clock and the indicator lamps, require continuous electric current, for this reason they are referred to as inactive appliances. This closed circuit current flows even if the device has been switched off.

Total discharge

Total discharge of the battery is imminent, if a battery is completely discharged by an active appliance and by closed circuit current and the off-load voltage falls below 12 V.



- ▷ Total discharge damages the battery.

Capacity Capacity refers to the amount of electricity which can be stored in a battery. The capacity of a battery is given in ampere hours (Ah). The so-called K20 value is normally used.

The K20 value indicates how much current a battery is able to dispense over a time period of 20 hours without causing damage, or how much current is required to charge a flat battery within 20 hours.

For example, if a battery can dispense 4 amps for 20 hours, then it has a capacity of $4 \text{ A} \times 20 \text{ h} = 80 \text{ Ah}$.

If more current flows, the discharging time of the battery will decrease proportionately.

External influences, such as temperature and age may alter the storage capacity of the battery. Capacity details refer to new batteries operating at room temperature.



- ▷ Depending on battery technology, capacity details have a conversion factor of 1.3 to 1.7, which lowers the real capacity by this value.

9.3 USB socket



- ▷ The charging current is maximum 1 amp.

The vehicle is equipped with one or more USB sockets.

All USB devices can be connected and charged via this USB socket.



Fig. 115 USB socket

9.4 12 V power supply



- ▷ Only connect devices with a maximum of 10 A to the sockets (Fig. 116,1) of the 12 V power supply.

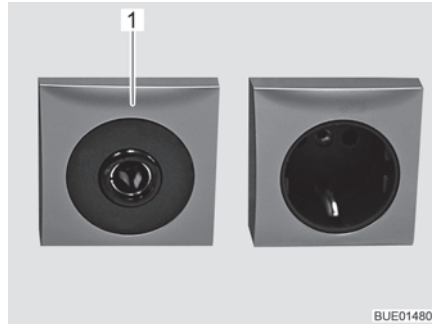

Fig. 116 12 V/10 A socket

9.4.1 Selector switch for radio (special equipment)



- ▷ Depending on the equipment level, a radio with integrated navigation device or a multimedia station will be present, referred to below simply as a "radio".
- ▷ The radio selector switch is installed in vehicles with Pioneer LCD display.



Fig. 117 Selector switch for operating behaviour

Switching the radio on and off with the ignition:

- Set the selector switch to the "0" position. The radio will be switched on and off with the ignition.

Operating the radio from the living area battery:

- Set the selector switch to the "1" position. The radio will be powered at all times from the living area battery.

9.4.2 Starter battery

The starter battery serves for starting the engine and supplies the electrical appliances of the base vehicle with voltage. See the instruction manual of the base vehicle for the position of the starter battery.



- ▷ The radio device in the driver's cabin is connected to the living area battery.

Discharging

This section contains information regarding the discharge of the starter battery.



- ▷ Total discharge damages the battery.
- ▷ Once a battery with acid is discharged, it can freeze in temperatures of below zero. This damages the battery.
- ▷ Recharge battery in good time.

The starter battery will be totally discharged via a closed circuit current (inactive appliances). Inactive appliances are optional devices such as a radio, alarm system, navigation system or a central locking system. Inactive appliances discharge the starter battery when the vehicle engine is switched off.

Low temperatures outside reduce the capacity available.

Charging

This section contains information regarding the charging of the starter battery.



- ▶ The acid in the battery is poisonous and corrosive. Any contact with the skin or the eyes is to be avoided. In the event of contact, rinse immediately with plenty of water (skin, eyes, clothes, objects) and seek medical attention if necessary.
- ▶ In the case of charging with an external charger there is danger of explosion. Sparks can be caused by attaching the battery terminals. Only charge the battery in a well ventilated area and away from naked flames or possible sources of sparks. Batteries can develop and release gases when they are charged.



- ▷ Before a temporary lay-up, charge the battery fully.
- ▷ Do not connect the battery cables to the wrong poles (red cable -> positive pole, black cable -> negative pole).
- ▷ If the starter battery or living area battery are disconnected, do not apply the ignition. There is a danger of short circuit from exposed cable ends.
- ▷ Before disconnecting or connecting the terminals of the battery, switch off the vehicle engine as well as the 230 V and 12 V power supplies and all appliances. Danger of short circuit!
- ▷ Observe the instruction manuals for the base vehicle and the charger.

The starter battery can only be fully charged with an external charger. When the vehicle is connected to the 230 V power supply, the transformer/rectifier charges the starter battery with a float charge only. Even in mobile operation, the vehicle engine alternator has a limited capability of completely charging the starter battery.

When charging the starter battery with an external charger, proceed as follows:

- Turn off the vehicle engine.
- Switch off the 12 V power supply on the panel. The indicator lamps or the displays on the panel go out.
- Switch off all gas appliances, all gas isolator taps and close the regulator tap on the gas bottle.
- Disconnect the starter battery from the vehicle (e.g. remove the battery terminals). There is a danger of short circuit when disconnecting the battery poles. For this reason, first disconnect the negative terminal on the starter battery and then the positive.
- Check that the external charger is turned off.
- Connect the external charger to the starter battery. Pay attention to the polarity: First connect the positive terminal "+" to the positive terminal of the starter battery, then connect the negative terminal "-" to the negative pole of the starter battery.
- Switch on the external charger.
- See the instructions for use of the connected charger for information concerning charge period required for the battery.
- See the specifications on the battery for information concerning its strength.
- Disconnect the charger in reverse order (the negative terminal first).
- Connect the battery terminals again (first the positive terminal).

9.4.3 Living area battery



- ▷ Use only the built-in transformer/rectifier to load the living area battery. In order to do this, connect the 230 V connection (CEE connector) of the vehicle to an external 230 V power supply.
- ▷ After the trip, charge the living area battery fully.
- ▷ Before a temporary lay-up, charge the battery fully.
- ▷ When the living area battery is changed, only use batteries of the same type and the same capacity.
- ▷ If there are several living area batteries, always change all the batteries together. The batteries must **always** be the same age and have the same capacity.
- ▷ When changing the living area battery, use only batteries which meet the minimum capacity of the charger. Observe the separate instruction manual for the charger. Lower-capacity batteries will generate a great deal of heat when they are charged. Danger of explosion!
- ▷ If the living area battery is replaced and the charging unit does not provide at least 10 % of the rating of a new battery, install an auxiliary charging unit. Example: With a battery capacity of 80 Ah, the charging unit must supply at least 8 A charging current.
- ▷ Before disconnecting or connecting the terminals of the battery, switch off the vehicle engine as well as the 230 V and 12 V power supplies and all appliances. Danger of short circuit!



- ▷ If the starter battery or living area battery are disconnected, do not apply the ignition. There is a danger of short circuit from exposed cable ends.
- ▷ Take note of the battery manufacturer's users and maintenance instructions.



- ▷ If possible, begin the trip with a fully charged living area battery. Therefore, charge the living area battery before starting the trip.
- ▷ During the trip, use every available opportunity to charge the living area battery.
- ▷ The radio device in the driver's cabin is connected to the living area battery.
- ▷ The battery is maintenance-free. Maintenance-free means:
 - It is not necessary to check the acid level.
 - It is not necessary to lubricate the battery poles.
 - It is not necessary to refill the distilled water.
 - Even a maintenance-free battery must be recharged.
 - Recommendation: perform a full charging cycle every 6 to 8 weeks.
 - Depending on the battery capacity and the charger, the charging cycle will last 24 to 48 hours.

When the vehicle is not connected to the 230 V power supply or the 230 V power supply is switched off, the living area battery supplies the living area with 12 V DC. The living area battery has a limited power supply only. For this reason, electrical appliances such as the radio and the lights should not be operated for a long time without using the 230 V power supply.

Position See chapter 17.

Discharging The living area battery is discharged by the closed circuit current which some electrical appliances continuously require.



- ▷ Total discharge damages the battery.
- ▷ Recharge battery in good time.



- ▷ Appliances such as the refrigerator, charger, solar charge regulator, panel, or similar, take power from the battery, even when the 12 V main switch is turned off. Therefore disconnect the living area battery from the 12 V power supply, if the vehicle will not be used for a long period of time.

Even a fully charged living area battery can, after an extended period, be fully discharged via a closed-circuit current (inactive appliances).

Low temperatures outside reduce the capacity available.

The self-discharge rate of the battery is also dependant on temperature. At 20 to 25 °C the self-discharge rate is approx. 3 % of the capacity per month. The self-discharge rate will increase with rising temperatures.

An older battery no longer has the complete capacity available.

The higher the number of active electrical appliances, the faster the energy of the living area battery is consumed.

9.4.4 Charging batteries via a 230 V power supply

If the vehicle is connected to the 230 V power supply, the living area battery and the starter battery are automatically charged by the charger module on the transformer/rectifier. The starter battery is only charged with a float charge. The charging current is adapted to suit the charging condition of the battery. This ensures that it is not possible to overload the battery.

To make use of the maximum output from the charger module on the transformer/rectifier, switch off all electrical appliances during charging.

9.4.5 Charging batteries via the vehicle engine

When the vehicle engine is running, the vehicle alternator recharges the living area battery and the starter battery. When the vehicle engine is switched off, the batteries are automatically disconnected from one another by a relay in the transformer/rectifier. This prevents the starter battery from being run down by electrical appliances in the living area. The starting capability of the vehicle is thus preserved. The charging condition of the living area battery or the starter battery can be read on the panel.

9.5 Transformer/rectifier (EBL 223)



- ▶ Potentially fatal electric shock or fire hazard.

In the event of a malfunction or damage, some parts of the device may be connected to line voltage.

- Do not carry out any maintenance or repair work on the unit.
- Do not open the device.
- Do not bring liquid into the device.
- In the event of damage on the cables or the housing, do not put the device into operation and disconnect it from the line voltage.



- ▷ Do not cover the ventilation slots. Danger of overheating!



- ▷ Depending on the model, not all slots for the fuses are occupied.
- ▷ If there are several living area batteries, use an auxiliary charging unit.
- ▷ Further information can be obtained in the device manufacturer's instruction manual.

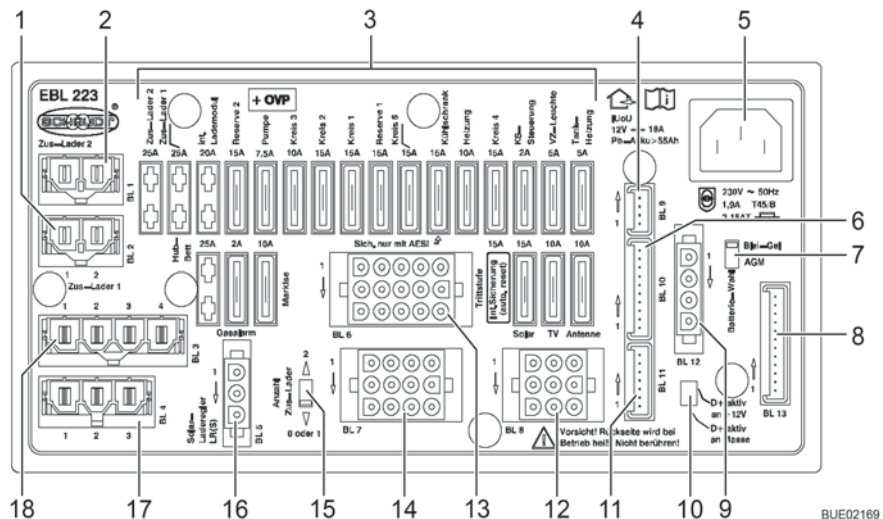

Fig. 118 Transformer/rectifier (EBL 223)

- 1 Connections BL 2 - auxiliary charging unit 1
- 2 Connections BL 1 - auxiliary charging unit 2
- 3 Flat fuses
- 4 Connections BL 9 - solar charge regulator
- 5 Mains connection 230 V
- 6 Connections BL 10 - panel
- 7 Battery selector switch (lead-gel/AGM)
- 8 Connections BL 13 - panel
- 9 Connections BL 12 - sensor for living area battery D+
- 10 Change-over switch D+ active to +12 V (D+ active to ground (factory setting))
- 11 Connections BL 11 - panel
- 12 Connections BL 8 - entrance step, TV, antenna
- 13 Connections BL 6 - heater, water pump, spare
- 14 Connections BL 7 - awning, tank heater, awning light
- 15 Selector switch for the number of auxiliary charging units
- 16 Connections BL 5 - solar charge regulator
- 17 Connections BL 4 - refrigerator from starter battery
- 18 Connections BL 3 - refrigerator

Functions The transformer/rectifier has the following functions:

- The transformer/rectifier charges the living area battery. The transformer/rectifier charges the starter battery with a float charge.
- The transformer/rectifier monitors the voltage in the living area battery.
- The transformer/rectifier distributes the current to the 12 V circuits and secures them. Devices with a maximum of 10 A can be connected to the sockets.
- The transformer/rectifier provides connections for a solar charge regulator, an auxiliary charging unit, as well as other control and monitoring functions.
- When the vehicle engine is turned off, the transformer/rectifier separates the starter battery electrically from the living area battery. This prevents the 12 V living area appliances from discharging the starter battery.

The transformer/rectifier only works in conjunction with a panel.

The power in the transformer/rectifier (≤ 18 A) is divided into charging current and current to the appliances. The charging current is always just the portion that is not being used by any appliances. If the current to the appliances exceeds the current available, then the living area battery is discharged.

The power supply of pull-down bed, awning, waste water tap, and awning light is disconnected automatically when the vehicle engine is running.

Position See chapter 17.

9.5.1 Battery separation



- ▷ Also switch off a refrigerator with automatic power selection system. The refrigerator will otherwise switch to gas operation.
- ▷ After deactivation of the battery separation, it may be necessary to reset the date and time. The remaining settings will be saved at the activation of the battery separation and will be maintained.

The battery separation switches off **all** 12 V appliances in the living area, even inactive ones. Even appliances such as the entrance step, basic lighting or the refrigerator will stop working. This prevents the living area battery from slowly discharging if the vehicle is not used for a longer period of time (e.g. temporary lay-up).

If the vehicle is connected to the 230 V power supply, the batteries can then be charged from the transformer/rectifier, even if the battery separation is activated.

This also applies for charging via a solar installation or fuel cell.

Activating/deactivating See section 9.6.2

9.5.2 Battery selector switch



- ▶ If the battery selector switch is set incorrectly, there is the danger of the formation of detonating (oxy-hydrogen gas). Danger of explosion!



- ▷ Incorrect setting of the battery selector switch damages the living area battery.
- ▷ The factory settings of the battery selector switch must not be changed.

9.5.3 Battery monitor



- ▷ You must fully recharge a discharged living area battery as soon as possible.

The battery monitor in the transformer/rectifier monitors the voltage in the living area battery.

A warning message is emitted if the battery voltage of the living area battery falls below 12 V.

If the battery voltage falls below 10.5 V, the battery monitor in the transformer/rectifier switches off all the 12 V appliances.

- Measures:
- Switch off all electrical appliances that are not absolutely essential at the corresponding switch.
 - If necessary, use the 12 V main switch to switch the 12 V power supply back on for a short while. This is only possible, however, when the battery voltage is above 11 V. If the voltage is below this level, the 12 V power supply cannot be switched on again until the living area battery has been recharged.

9.5.4 Charging the battery

When the vehicle engine is running, a relay in the transformer/rectifier alternator switches on the living area battery and the starter battery together and recharges them with the vehicle generator. When the vehicle engine is switched off, the batteries are automatically disconnected from one another again by the transformer/rectifier. This prevents the starter battery from being run down by electrical appliances in the living area. The starting capability of the vehicle is thus preserved. The terminal voltage of the living area battery or the starter battery can be read on the panel.

If the vehicle is connected to the 230 V power supply via the CEE socket outlet, the living area battery and the starter battery are charged by the charger module on the transformer/rectifier. The starter battery is only charged with a float charge. The charging current is adapted to suit the charging condition of the battery. This ensures that it is not possible to overload the battery.

To make use of the maximum output from the charger module on the transformer/rectifier, switch off all electrical appliances during charging.

9.5.5 Entrance step

After an overload, the self-resetting fuse will reset automatically within approx. 1 minute.

9.5.6 Solar charge regulator

Before removing or changing the living area battery, disconnect the connector of the solar charge regulator from the transformer/rectifier.

9.6 Panel LT 511



- ▷ The luminance of the LEDs and the symbols adapts automatically to the ambient light.
- ▷ The displays can only be called up if the 12 V power supply is switched on.
- ▷ As soon as a button is pressed, the gauge is automatically illuminated. The display goes out 20 seconds after the last key has been pressed.
- ▷ Further information can be obtained in the manufacturer's instruction manual.

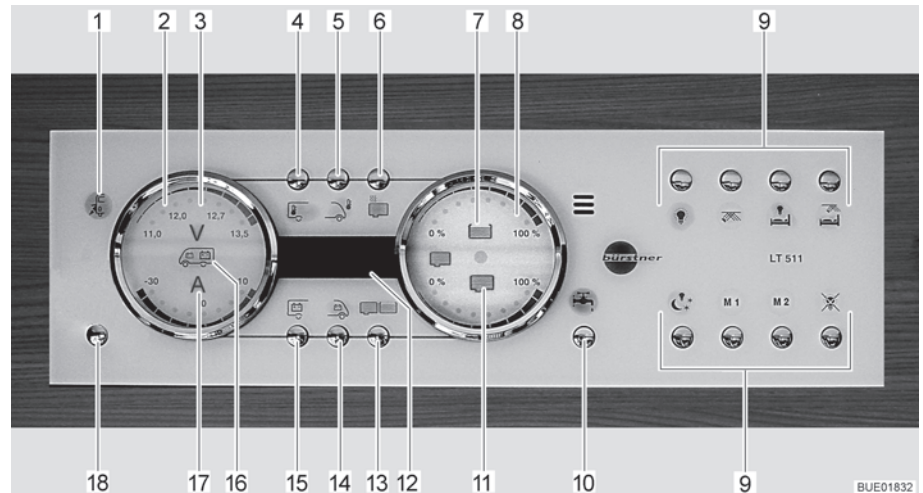

Fig. 119 Panel LT 511

- 1 230 V indicator lamp
- 2 Batteries gauge
- 3 Volt symbol
- 4 Interior temperature button
- 5 External temperature button
- 6 Not used/without function
- 7 Water tank symbol
- 8 Tanks gauge
- 9 Light control button
- 10 Water pump button
- 11 Waste water tank symbol
- 12 Digital display, temperature
- 13 Tanks button
- 14 Starter battery button
- 15 Living area battery button
- 16 Symbol for starter battery and living area battery
- 17 Ampere symbol
- 18 Button for 12 V power supply (12 V main switch)

9.6.1 230 V indicator lamp

The 230 V indicator lamp (Fig. 119,1) illuminates whenever line voltage is available at the transformer/rectifier input.



- ▷ The 230 V indicator lamp also lights up whenever the 12 V main switch is switched off.

9.6.2 12 V main switch

The 12 V main switch (Fig. 119,18) switches the panel and the 12 V power supply of the living area on and off.

Exception: Heater, basic light (lighting in the entrance area) and entrance step remain operational.

Switching on: ■ Briefly press the 12 V power supply button (Fig. 119,18). The 12 V living area power supply is switched on. The "12 V" indicator lights up.



▷ If, after switching on, the "11.0" LED of the volt indicator and the "V" volt symbol (Fig. 119,3) in the batteries gauge (Fig. 119,2) flash, the voltage of the living area battery is too low. Charge battery.

▷ If, after switching on, the "12 V" indicator and the "V" volt symbol (Fig. 119,3) flash three times, battery separation is activated. Deactivate battery separation.

Switching off: ■ Briefly press the 12 V power supply button (Fig. 119,18). The 12 V living area power supply is switched off. The "12 V power supply" indicator goes out.

Activating battery separation (transformer/rectifier without battery cut-off switch):

- Switch off 12 V power supply.
- Press button for living area battery (Fig. 119,15) and hold it down for approx. 10 seconds. The "V" volt symbol (Fig. 119,3) and the "12 V" indicator flash three times. The living area battery is disconnected from the 12 V power supply.

Deactivating battery separation (transformer/rectifier without battery cut-off switch):

- Press the 12 V power supply button (Fig. 119,18) and hold it down for approx. 5 seconds. The "V" volt symbol (Fig. 119,3) and the "12 V" indicator flash three times. The living area battery is connected to the 12 V power supply. The indicator lights up after approx. 5 seconds.



▷ When leaving the vehicle, switch off the main 12 V power supply at the panel. This prevents any unnecessary discharge of the living area battery.

▷ Appliances, such as control units (e.g. solar charge regulator, defroster or panel) or fitted appliances (e.g. heating, refrigerator or step) continue to take power from the battery capacity, even if the 12 V power supply on the panel is switched off. Therefore disconnect the living area battery from the 12 V power supply via the switch on the transformer/rectifier if the vehicle will not be used for a long period of time.

9.6.3 Batteries gauge

The voltage and charging/discharging of the living area battery or the starter battery voltage can be indicated using the batteries gauge.

- Displays: ■ Press button for living area battery (Fig. 119,15). The "V" volt symbol (Fig. 119,3) lights up. The "A" ampere symbol (Fig. 119,17) lights up as either white or red depending on whether it is charging or discharging. The battery voltage and electricity of the living area battery are displayed via the LEDs in the gauge.
- Press button for starter battery (Fig. 119,14). The "V" volt symbol (Fig. 119,3) lights up. The battery voltage of the starter battery is displayed using the LEDs in the gauge.

The following tables will help you interpret the statuses displayed on the panel.

Volt indicator (blue)

1 LED	2 LEDs	3 LEDs	4 LEDs	5 LEDs	6 LEDs	7 LEDs	8 LEDs
< 11.0 V	11.5 V	12.0 V	12.2 V	12.5 V	12.7 V	13.0 V	> 13.5 V

Danger of total discharge (battery alarm)

Battery voltage (values during operation)	Mobile operation (vehicle moving, no 230 V connection)	Battery operation (vehicle stationary, no 230 V connection)	Power operation (vehicle stationary, 230 V connection)
11 V or less ¹⁾	12 V power supply overload	If appliances are switched off: Battery flat If appliances are switched on: Battery overload	12 V power supply overload
	The battery is not charged by the alternator, the alternator's regulator is defective		The battery is not charged by the transformer/rectifier, the transformer/rectifier is defective
11.5 V to 13 V	12 V power supply overload ²⁾	Normal range	12 V power supply overload ²⁾
	The battery is not charged by the alternator, the alternator's regulator is defective		The battery is not charged by the transformer/rectifier, the transformer/rectifier is defective
Over 13.5 V	Battery is being charged (main charge)	Occurs only briefly after charging	Battery is being charged (main charge)

¹⁾ The battery guard switches all the appliances off (at 10.5 V).

²⁾ If the voltage does not exceed this range for several hours.

Values for off-load voltage	Charging condition of the battery
12.0 V or less	Discharge or totally discharge
12.2 V	25 %
12.3 V	50 %
More than 12.8 V	Full



▷ Total discharge causes irreparable damage to the battery.



▷ Measure the off-load voltage preferably several hours after the previous charging (e.g. in the morning) and not directly after a current drain.

Ampere indicator (blue)

1 LED	2 LEDs	3 LEDs	4 LEDs	5 LEDs	2 LEDs	3 LEDs	4 LEDs
Discharging with:					Charging with:		
Ap- prox. 0 A	> 1 A	> 3 A	> 10 A	> 30 A	> 1 A	> 3 A	> 10 A

Current displayed	System status	"A" ampere symbol
-30 A to -10 A	Battery is being heavily discharged	Lights up red
-10 A to -1 A	Battery is being discharged	Lights up white
0 A	Battery current is low or 0 A	Lights up white
+1 A to +10 A	Battery is being charged	Lights up white

9.6.4 Tank gauge

The water and waste water quantities can be indicated using the tank gauge.

- Displays:
- Press tanks button (Fig. 119,13). The water tank (Fig. 119,7) and waste water tank (Fig. 119,11) symbols light up. The fill levels of the water tank (upper scale) and of the waste water tank (lower scale) are indicated using the LEDs in the gauge.

The table below will help you interpret the levels displayed on the panel.

Level indicator (blue)

1 LED	2 LEDs	3 LEDs	4 LEDs	5 LEDs	6 LEDs	7 LEDs	8 LEDs
25 %		50 %		75 %		100 %	

9.6.5 Alarms



- ▷ Perform display checks regularly.
- ▷ It is best to perform checks in the morning, before the 12 V appliances are switched on.

The table below will help you interpret the alarms displayed on the panel.



- ▷ Total discharge damages the battery.



- ▷ If the battery voltage falls below 10.5 V, the battery monitor in the transformer/rectifier switches off all the 12 V appliances. The battery cut-off switch is tripped.

Display	Signification	Remedy
The "V" volt symbol (Fig. 119,3) and the LED "11.0" flash when the values for the living area battery are called up	The battery voltage has fallen below 11 V. Danger of total discharge	Switch off all 12 V appliances and charge the battery either by mobile operation or by connection to a 230 V supply
The "V" volt symbol (Fig. 119,3) flashes when the 12 V power supply is switched off	The 12 V power supply can no longer be switched on	Switch off all 12 V appliances and charge the battery either by mobile operation or by connection to a 230 V supply
	Battery overvoltage	Contact customer service
The "V" volt symbol (Fig. 119,3) and the LEDs "11.0" and "12.0" flash when the values for the starter battery are called up	The battery voltage has fallen below 11 V. Danger of total discharge	Switch off all 12 V appliances and charge the battery either by mobile operation or by connection to a 230 V supply

Tank alarm The water tank symbol (Fig. 119,7) or waste water tank symbol (Fig. 119,11) flashes when the water tank is empty or the waste water tank is full.



▷ If, when the fill levels are called up, the LEDs in the scale flash in addition to the tank symbol, a sensor error has occurred. Clean tank sensors.

Measures: ■ Fill water tank or empty waste water tank.

9.6.6 Temperature display

The internal and external temperatures can be indicated using the digital display (Fig. 119,12).

Displays: ■ Press the button for the internal temperature (Fig. 119,4). The internal temperature is displayed.
■ Press external temperature button (Fig. 119,5). The external temperature is displayed.

9.6.7 Switch for water pump

The water pump can be turned on and off using the water pump button (Fig. 119,10).

Switching on: ■ Press the water pump button (Fig. 119,10). The symbol lights up.

Switching off: ■ Press the water pump button (Fig. 119,10). The symbol goes out.



▷ The switch status of the water pump is saved when the 12 V power supply is switched off. This means: If the water pump was switched on when the 12 V power supply was switched off, it is also switched on after the 12 V power supply is switched back on.

9.7 Solar installation (special equipment)



- ▷ Protect the solar collectors (solar module) against mechanical overload.



- ▷ The solar installation supplies the most current under optimal sunlight conditions.
- ▷ Provide the solar collectors (solar module) open access to sunlight.
- ▷ Sunlight is greater in the open air than under trees and bridges.
- ▷ Tarpaulins block out sunlight.
- ▷ Always keep collector surfaces free of contamination.
- ▷ Also read the manufacturer's instruction manual.

The solar installation provides an environmentally compatible power supply independent of the mains. It converts energy from sunlight into electric current. The solar installation supplies additional current for the battery and appliances.

The solar charge regulator has an integrated overload protection as well as deep discharge protection.

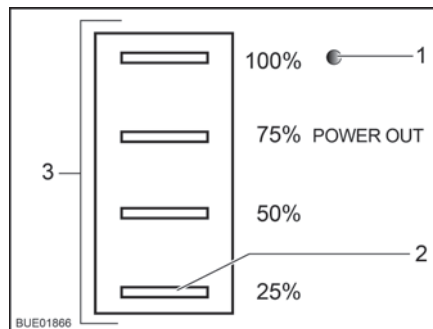

Fig. 120 Status indicator, solar charge regulator

Four LEDs (Fig. 120,3) show the current operating state. Another LED (Fig. 120,1) shows whether output voltage is present.

LED	Status	Signification
Operating state LEDs (Fig. 120,3)	Flashing cyclically	Battery being charged
	Lit up	Battery is fully charged
LED 25 % (Fig. 120,2)	Flashing	Battery is fully discharged
Output voltage LED (Fig. 120,1)	Lit up	Output voltage present
	Not lit up	Output voltage not present

9.8 230 V power supply



- ▶ Only allow qualified personnel to work on the electrical system.
- ▶ Have the vehicle's electrical system checked by a qualified electrician at least once every 3 years. If the vehicle is used frequently, an annual check is recommended.

The 230 V power supply provides electricity for the following devices (if present):

- sockets with earth contact for appliances with maximum 10 A
- refrigerator
- transformer/rectifier
- an auxiliary charging unit
- air conditioning unit

The electrical appliances connected to the 12 V power supply of the living area are supplied with voltage by the living area battery.

Connect the vehicle to an external 230 V power supply system as often as possible. The charger module in the transformer/rectifier automatically charges the living area battery. In addition to this, the starter battery is charged with a float charge of approx. 2 A.

Depending on the equipment, optional devices are fuse-protected by their own two-pole automatic circuit breaker.

9.8.1 230 V connection (CEE socket outlet)



- ▷ Overvoltage can damage connected devices. Overvoltage can be caused by lightning, irregular voltage sources (e.g. petrol-operated generators) or power connections on ferries for example.

Requirements concerning the 230 V connection

- The connecting cable, the plug connectors at the point of supply and the plug connector to the vehicle must comply with IEC 60309. The standard designation for the plug connectors is "CEE blue".
- Use H07RN-F rubber sheathed cable with a minimum cable cross-section of 2.5 mm² and a maximum length of 25 m.
- Earth contact connectors (safety) are not permitted. The interconnection of CEE/safety adapters is also prohibited.

9.8.2 Connecting the 230 V power supply



- ▶ The external 230 V power supply must be protected by fuse with a fault current protection switch (FI-switch, 30 mA).
- ▶ To prevent overheating, the cable must be fully uncoiled from the cable reel.
- ▶ In case of doubt or if the 230 V supply is not available or is faulty, contact the operator of the power supply device.



- ▷ The 230 V connection in the vehicle is equipped with a combined fault current protection switch with safety cut-out.
- ▷ For the connection points on camp sites (camping distributors) fault current protection switches (FI-switches, 30 mA) are obligatory.

The vehicle can be connected to an external 230 V power supply.



Fig. 121 230 V fuse box with safety cut-out and FI-switch



Fig. 122 230 V connection on vehicle

Connecting the vehicle:

- Check whether the power supply device is suitable regarding connection, voltage, frequency and current.
- Check whether the cables and connections are suitable.
- Check the plug connectors and cables for visible damage.
- Switch off the safety cut-outs (Fig. 121,2 and 4) in the fuse box (Fig. 121,3).
- Open the cover of the 230 V connection on the vehicle (Fig. 122) and insert the plug connector. Ensure that the detent of the spring-mounted pivoting cover is engaged in position.
- Plug the connector of the connecting cable into the socket of the power supply device. Ensure that the detent of the spring-mounted pivoting cover is engaged in position.
- Switch on the safety cut-outs in the fuse box.

Checking the fault current protection switch:

- When the vehicle is connected to the 230 V supply, press the test button (Fig. 121,1) of the fault current protection switch (FI-switch) (Fig. 121,4) in the fuse box (Fig. 121,3). The fault current protection switch must trip.
- Switch the fault current protection switch back on again.

Unplugging the connection:

- Switch off the safety cut-outs (Fig. 121,2 and 4) in the fuse box (Fig. 121,3).
- Loosen the detent on the power supply device and unplug the connection cable from the socket.
- Loosen the detent on the vehicle, unplug the plug connector and close the cover of the 230 V connection.

9.9 Fuses



- ▶ Only replace defective fuses when the cause of the defect is known and has been remedied.
- ▶ Replace defective fuses only after the power supply has been turned off.
- ▶ Never bridge or repair fuses.
- ▶ Only replace faulty fuses with a new fuse with the same rating.

9.9.1 12 V fuses

The appliances connected to the 12 V power supply in the living area are fused individually. The fuses are accessible at different positions in the vehicle.

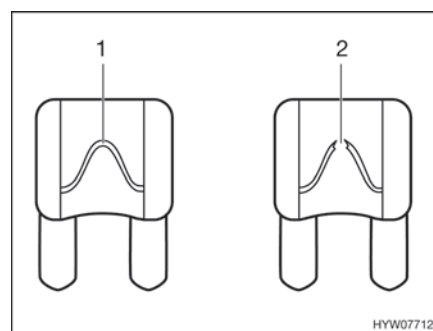

- 1 Unbroken fuse element
- 2 Broken fuse element

Fig. 123 12 V fuse

An intact 12 V fuse can be detected by the unbroken fuse element (Fig. 123,1). If the fuse element is broken (Fig. 123,2), change the fuse.

Before changing fuses, take the function, value and colour of the relevant fuses from the following specifications. When changing fuses, only use flat fuses with the values shown below.

Fuses on the starter battery

The fuses are installed in the vicinity of the starter battery. The starter battery is on the floor between the seats in the driver's cabin and can be accessed under a cover.

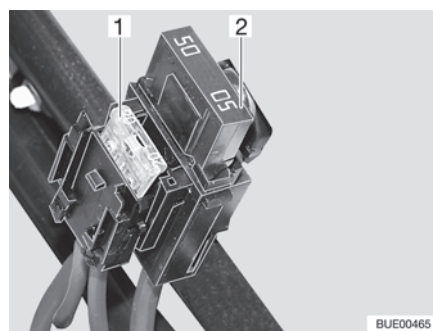

- 1 Flat fuse 20 A/yellow (for the refrigerator)
- 2 Jumbo flat fuse 50 A/red

Fig. 124 Fuses on the starter battery

Fuses on the living area battery

The fuses are fitted next to the living area battery.

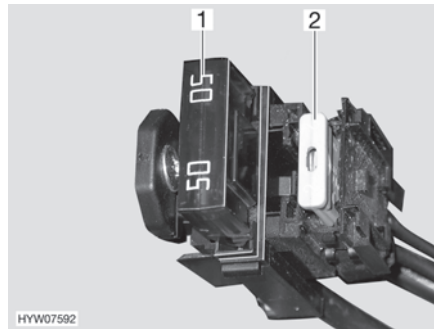

- 1 Jumbo flat fuse 50 A/red
(for the transformer/rectifier)
- 2 Flat fuse 2 A/grey
(for battery sensor, living area battery)

Fig. 125 Fuses on the living area battery

Fuses on the relay box AD01

A relay box (AD01) is installed in one of the two seat consoles. The relay box helps generate the signals for the chassis lighting not provided by the base vehicle. The relay box can be used anywhere.

The circuit used by us can vary from the circuit provided by the manufacturer. Consequently, the circuit can also vary from the display on the relay box type plate, which the manufacturer affixed.

FuNo	Function	Value/colour
B2	Cl. 15 (ignition on)	15 A blue
B3	Cl. 30 (constant positive)	15 A blue
B5	Signal D+	Internal Polyswitch (2 A)
B6	Spare	15 A blue
B7	Front side marker lights (white/red)	5 A light brown

Fuses on the transformer/rectifier (EBL 223)

Function	Value/colour
Auxiliary charging unit 2	25 A white
Auxiliary charging unit 1	25 A white
Internal charger module	20 A yellow
Spare 2	15 A blue
Pump (for water)	7.5 A brown
Circuit 3	10 A red
Circuit 2	15 A blue
Circuit 1	15 A blue
Spare 1	15 A blue
Circuit 5	15 A blue
Refrigerator	15 A blue
Heater	10 A red
Circuit 4	15 A blue
Refrigerator control	2 A grey
Awning light	5 A light brown

Function	Value/colour
Tank heater	5 A light brown
Antenna	10 A red
TV	10 A red
Solar	15 A blue
Step (self-resetting)	15 A
Awning	10 A red
Gas alarm	2 A grey
Pull-down bed	25 A white

Fuses for air suspension

The fuses are installed in the base vehicle's fuse box.

Function	Value/colour
Control	7.5 A brown
Compressor	40 A green

Fuse for the Thetford toilet (swivel toilet)

The fuse is located in the locker wall of the Thetford cassette.

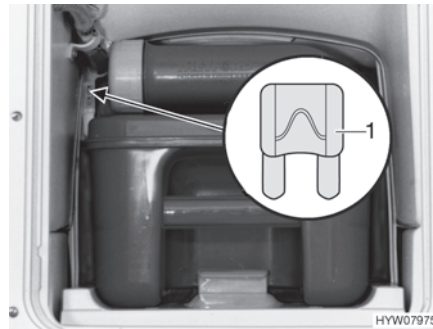

1 Flat fuse 3 A/purple

Fig. 126 Fuse for the Thetford toilet

Changing:

- Open the flap for the Thetford cassette on the outside of the vehicle.
- Pull out the Thetford cassette completely.
- Replace fuse (Fig. 126,1).

Protection for waste water heating

The control unit has an electronic overload protection. In the event of an overload, the waste water heating switches off. To restart, disconnect the control unit briefly from the power supply.

Depending on the model, the supply voltage of the waste water heating will be protected by the fuse circuit Spare 3 or Spare 4.

9.9.2 230 V fuse



- ▷ Check the fault current protection switch for each connection to the 230 V power supply, at least once every 6 months.



- ▷ In international language usage, the fault current protection switch is also denominated RCD (Residual Current Device).



Fig. 127 230 V fuse box

A combined fault current protection switch / safety cut-out (Fig. 127,4) in the fuse box (Fig. 127,3) protects the complete vehicle from fault current (0.03 A).

The integrated safety cut-out (16 A) protects the 230 V sockets, the power supply unit, the auxiliary charging unit, and the refrigerator.

For vehicles with special equipment, (e.g. air conditioning unit), the appliance is protected by an additional safety cut-out (10 A) (Fig. 127,2).

Position See chapter 17.

Checking the fault current protection switch:

- When the vehicle is connected to the 230 V power supply, press the test button (Fig. 127,1). The fault current protection switch must trip.

9.10 External socket (special equipment)

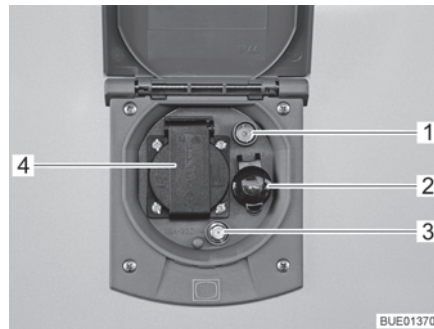

- 1 TV socket
- 2 12 V socket
- 3 SAT socket
- 4 230 V socket

Fig. 128 External socket

The 230 V socket and the 12 V socket can be used to power electrical devices in the awning.

Connection possibilities

TV socket and SAT socket offer various possibilities for TV operation:

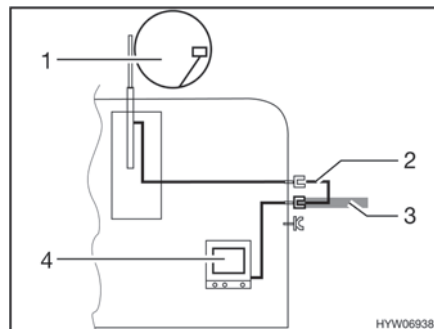

Fig. 129 TV inside the vehicle

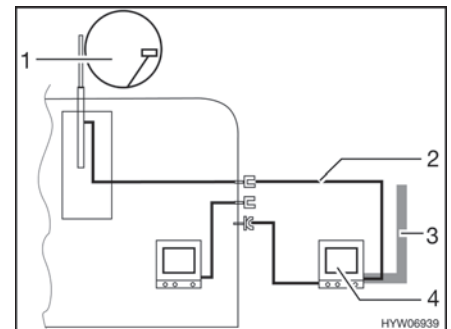

Fig. 130 TV in the awning

- TV inside the vehicle (Fig. 129,4): Connection to roof antenna (Fig. 129,1) with connection cable (Fig. 129,2)
- TV inside the vehicle (Fig. 129,4): Connection to external antenna (Fig. 129,3)
- TV inside the awning (Fig. 130,4): Connection to roof antenna (Fig. 130,1) with connection cable (Fig. 130,2)
- TV inside the awning (Fig. 130,4): Connection to external antenna (Fig. 130,3)

9.11 Circuit diagrams

9.11.1 Circuit diagrams, interior

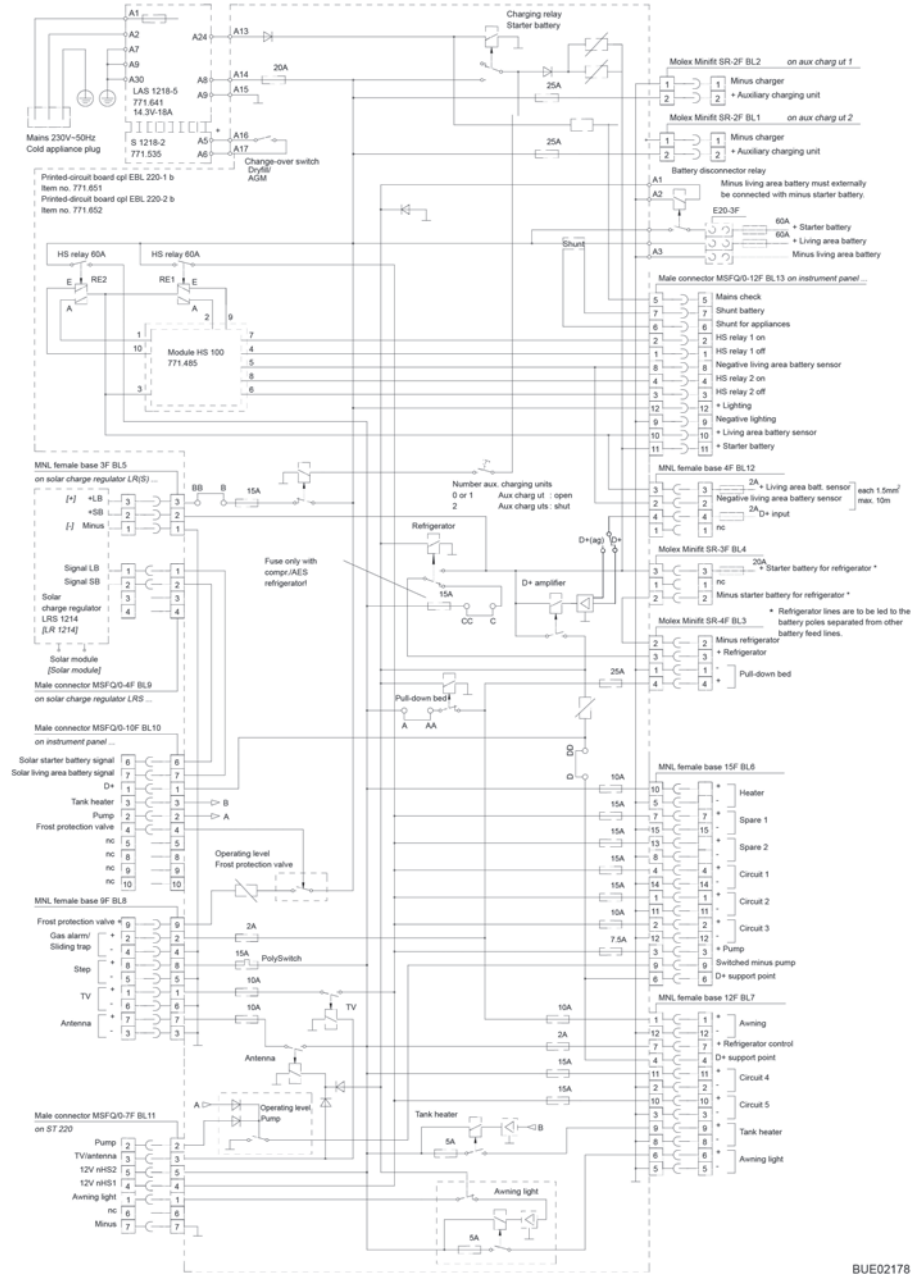

Fig. 131 Circuit diagram, interior (EBL 223)

BUE02178

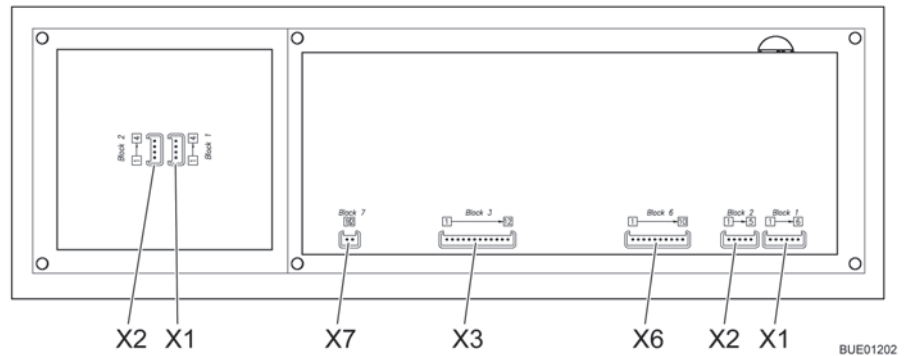

Fig. 132 Block diagram, panel (LT 511)

X1	Lumberg MSFQ 6-pin
1	Full
2	3/4
3	1/2
4	1/4
5	Base water tank
6	n. c.
X2	Lumberg MSFQ 5-pin
1	Full
2	3/4
3	1/2
4	1/4
5	Base waste water tank
X3	Lumberg MSFQ 12-pin
1	Main switch relay 1 off
2	Main switch relay 1 on
3	Main switch relay 2 off
4	Main switch relay 2 on
5	Mains signal
6	Shunt for appliances
7	Shunt battery
8	Negative living area battery sensor
9	n. c.
10	+ Living area battery sensor
11	+ Starter battery 12 V
12	+ Lighting

X6	Lumberg MSFQ 10-pin
1	D+
2	Pump
3	Tank heater
4	Anti-freeze
5	n. c.
6	Solar starter battery
7	Solar living area battery
8	n. c.
9	n. c.
10	n. c.
X7	Lumberg MSFQ 2-pin
1	KTY Pin 1
2	KTY Pin 2
X1	Lumberg MSFQ 4-pin
1	ADI1
2	ADI2
3	+12 V
4	GND
X2	Lumberg MSFQ 4-pin
1	ADI1
2	ADI2
3	+12 V
4	GND

9.11.2 Circuit diagram, exterior

Fiat

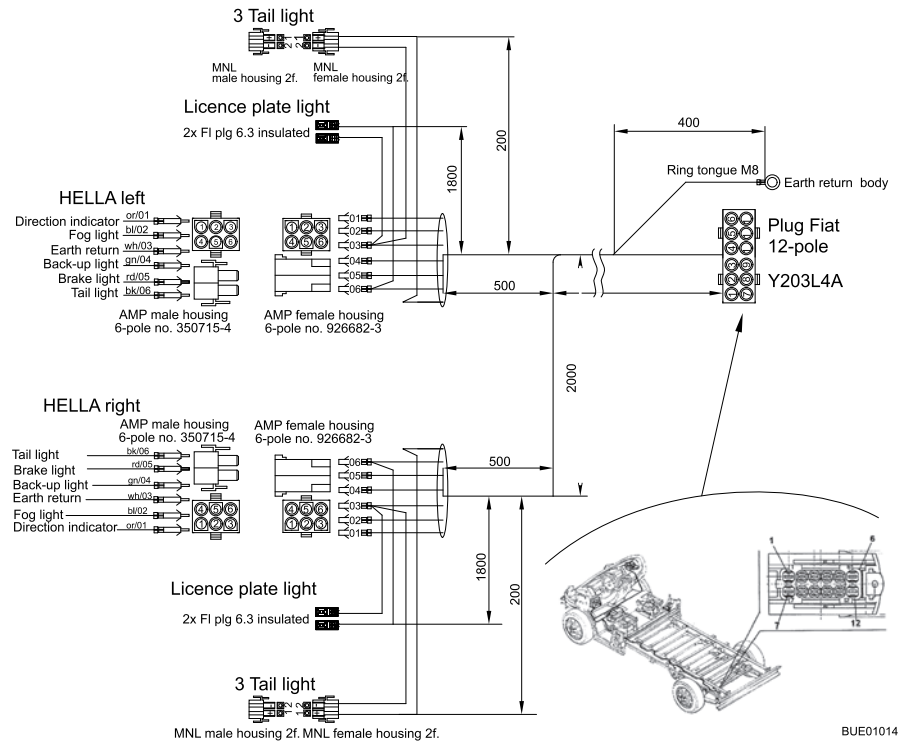

Fig. 133 Circuit diagram, exterior

Left side

Bürstner colours	Connection
Grey	Left direction indicator
Blue	Fog tail light
White	Earth return
Green	Back-up light
Red	Brake light
Black	Left rear light

Right side

Grey	Right direction indicator
Blue	Fog tail light
White	Earth return
Green	Back-up light
Red	Brake light
Black	Right rear light

Chapter overview

This chapter contains instructions regarding the appliances of the vehicle.

The instructions refer exclusively to the operation of the appliances.

Further information about the appliances can be found in the instruction manuals for the appliances, included separately with the vehicle.

The instructions address the following topics:

- heater
- air conditioning unit
- boiler
- gas cooker
- gas oven
- microwave oven
- extractor hood
- refrigerator

10.1 General



- ▷ For safety reasons, spare parts for pieces of heating appliances must correspond with manufacturer's instructions and be permitted by the manufacturer as a spare part. These spare parts may only be fitted by the manufacturer or an authorised specialist workshop.



- ▷ Further information can be obtained in the instruction manual for the respective appliance.

The heater, air conditioning unit, boiler, cooker and refrigerator are fitted depending on the model of the vehicle.

In this instruction manual a description is given only for the operation of the appliances and their particular features.

To operate gas appliances, first open the regulator tap on the gas bottle and the gas isolator tap corresponding to the appliance.

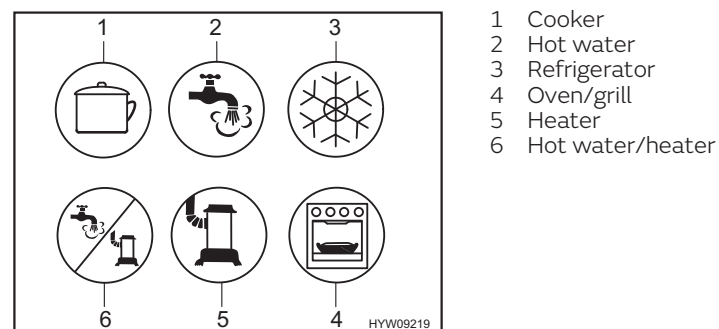

Fig. 134 Symbols for the gas isolator taps

10.2 Heater



- ▶ Never let gas escape unburned due to danger of explosion.
- ▶ Never run the heater in gas operation when refuelling, on ferries or in the garage. Danger of explosion!
- ▶ Never operate the heater in gas operation in closed spaces (e.g. garages). Danger of poisoning and suffocation!
- ▶ The waste gas vent may neither be closed nor blocked.
- ▶ Do not use the space behind the heater as a storage compartment.
- ▶ The water in the boiler can be heated up to 65 °C. Risk of scalding!



- ▷ Hot air may damage the floor covering. Do not point the air outlet nozzles towards the floor covering.

Initial start-up

When lighting the heater for the first time a small amount of smoke and odour will occur. Immediately set the operating switch of the heater to its highest position. Open doors and windows and ventilate well. Smoke and odour will disappear by themselves after a while.

10.2.1 Models with waste gas vent on the right-hand side of the vehicle



- ▶ If the awning is put up and the heater is running in gas operation, exhaust gases from the heater can escape into the awning area. Danger of suffocation! Make sure the area is sufficiently ventilated.

10.2.2 Alde hot-water heater



- ▷ Never run hot-water heater without heating fluid. Observe notes in chapter 13.
- ▷ Never drill holes in the floor. This might damage the hot-water pipes.



- ▷ The circulating pump must always be turned on when the hot-water heater is in operation.
- ▷ We recommend to bleed the heating system after the initial heater operation and to check the glycol content. Observe notes in chapter 13.
- ▷ When the heater is turned on, it starts with the last settings used.
- ▷ For further information, see the separate manufacturer's instruction manual and observe the maintenance instructions found in chapter 13.
- ▷ For further information about the use of the boiler see section "Boiler".

The hot-water heater is installed at the bottom of the wardrobe or under the beds.

Operating unit

The operating unit is divided into two sections:

- Display (touch screen)
- Operating buttons

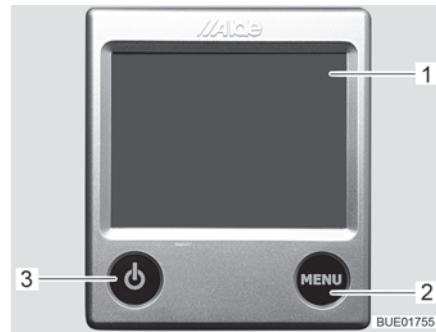

- 1 Display (touch screen)
- 2 "Menu" button
- 3 "On/Off" button

Fig. 135 Operating unit (hot-water heater)



- ▷ When no button is pressed, the operating unit automatically switches to home position after two minutes.
- ▷ Changes to the settings are saved automatically after 10 seconds.

Operating buttons

The operating buttons have the following functions:

Pos. in Fig. 135	Button	Function
2	MENU	Open adjustment menu
3		Activate heating

Display

The display (Fig. 135,1) is designed as a touch screen. Touching the symbols calls up the relevant function.







Fig. 136 Start screen (operating unit)

Start screen

The start screen appears on the display after the heater is switched on. The start screen contains the following information:

Symbol	Signification
	This symbol appears when the circulating pump is activated
	This symbol appears when the Automatic start function of the heater is activated
	This symbol appears when the daytime automatic mode function is activated
	This symbol appears when the night-time automatic mode function is activated

Symbol	Signification
	This symbol appears when a switching facility for gas bottles is activated
	This symbol appears when a voltage of 230 V is present at the heater
	The internal temperature is displayed next to this symbol
	The external temperature is displayed next to this symbol if an external sensor is fitted







Adjustment menu

The "MENU" button calls up the adjustment menu. The meanings of the individual symbols are described in the following table.



Fig. 137 Adjustment menu (operating unit)

The values can be increased or reduced via the "+" or "-" symbols.

Symbol	Signification
	Setting the desired temperature (from +5 °C to +30 °C)
	Setting the water temperature in the boiler
	Setting the heat output in electrical operation
	Heater button in gas operation On/Off
	Tool menu button
	AC button for switching on the automatic air conditioning (only visible when the Truma Aventa air conditioning unit is installed)
	Button for activated functions

Tool menus

The various heater functions can be called up and adjusted via the tool menus. The arrow symbols are used to change between the menus. The meanings of the individual symbols are described in the manufacturer's instruction manual.



Selecting the operating mode

The hot-water heater can be operated with the following energy sources:

- Gas operation
- 230 V electrical operation
- Gas and 230 V electrical operation

The operating mode is selected from the operating unit.

Selecting gas operation:

- Press "" button. The button lights up green. The gas operation is activated.
- Press "" button again. The button lights up blue. The gas operation is switched off.

Selecting 230 V electrical operation:

- Press the "+" button next to the "" symbol until the desired heat output is reached.
- ▷ Select the output level during 230 V electrical operation in such a way that it corresponds to the 230 V connection protection:
 - Level 1 (1 kW) at 6 A
 - Level 2 (2 kW) at 10 A
 - Level 3 (3 kW) at 16 A

Selecting gas and 230 V electrical operation:

- Select gas operation and 230 V electrical operation on the operating unit.
- ▷ If gas and 230 V electrical operation is selected and if the vehicle is connected to the 230 V power supply, then the hot-water heater at first only operates in 230 V electric operation. Only if the heat output is insufficient does the gas operation also automatically switch on.
- ▷ The gas operation is only possible when the regulator tap on the gas bottle and the gas isolator tap are opened.
- ▷ 230 V electrical operation is only possible when the vehicle is connected to the 230 V power supply.

When the heater is turned on, it starts with the last set operating mode.

Switching on the heater:

- Press "" button. The Start screen appears in the display. The heater starts automatically.

Switching off the heater:

- Press "" button. The heater is turned off.

Setting the rotational speed of the circulating pump



- ▷ The hot-water heater is equipped with a very powerful pump. Only operate the pump for approx. 5 minutes on full output when the system is emptied or the pipes are bled. Otherwise, this will increase wear; loud operating noises are the result.

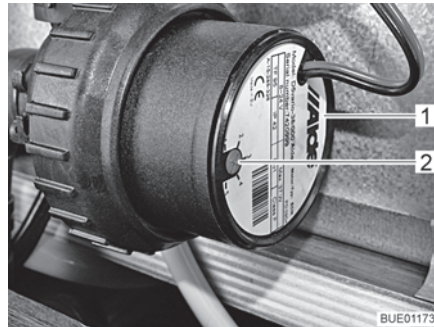

Fig. 138 Speed reduction

The rotational speed of the circulating pump can be set with the control knob (Fig. 138,2). At a lower rotary speed, the operating sounds of the pump are quieter.

The control knob is located on the circulating pump (Fig. 138,1).

Setting the output:

- Turn the control knob (Fig. 138,2) in an anticlockwise direction. The output is reduced.
- Rotate the control knob in a clockwise direction. The output is increased.

3-way valve

For models with a rear bed, a 3-way valve is connected to the hot water heater circulation. The 3-way valve is installed in the rear garage. The 3-way valve can be accessed via an external flap.

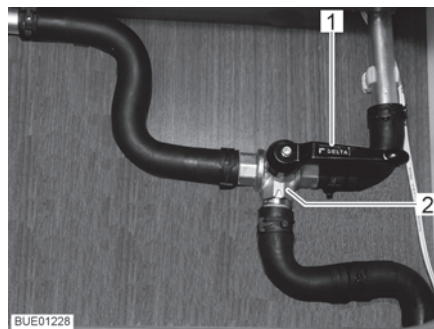

Fig. 139 3-way valve

Opening the heat circulation in the rear area:

- Set the lever (Fig. 139,1) of the 3-way valve (Fig. 139,2) parallel to the straight flow direction (Fig. 139).

Locking the heat circulation in the rear area:

- Set the lever (Fig. 139,1) of the 3-way valve (Fig. 139,2) transverse to the straight flow direction.

Alde heat exchanger (special equipment)



- ▷ The heat exchanger only works when the vehicle engine is running.
- ▷ If the heat exchanger is not being used (as in the summer), the heat exchanger on the stopcock should be shut off.

The heat exchanger can be used to heat the living area of the vehicle during travel without operating the hot-water heater in the living area.

The heat exchanger is connected to the vehicle engine's cooling circuit and thus has the same function as the vehicle heater.

Heat output is set with the living area's heating regulator.

The heat exchanger stopcock is located directly on the exchanger.

Turning on the vehicle heating by heat exchanger:

- Make sure the heat exchanger stopcock is open.
- Press the "⏻" button (Fig. 135,3) on the operating unit (Fig. 135). The Start screen appears in the display. That turns on the heating control system and makes the circulating pump run.
- Press "MENU" button (Fig. 135,2).
- Turn off gas operation or 230 V electrical operation (if turned on).
- Set the desired room temperature. To do that, press the "+" or "-" button next to the "🏠" symbol.

Turning off the vehicle heating by heat exchanger:

- Press the "⏻" button (Fig. 135,3) on the operating unit (Fig. 135).



Fig. 140 Alde heat exchanger

- Turning on: ■ Set stopcock handle (Fig. 140,1) parallel to the pipe.
- Turning off: ■ Set stopcock handle (Fig. 140,1) at a right angle to the pipe.

Position

The heat exchanger is installed in the rear bench seat of the central seating group.

Alde auxiliary circulating pump (special equipment)



- ▷ The auxiliary circulating pump works only if the heat exchanger has been installed and started, and the hot-water heater is running.

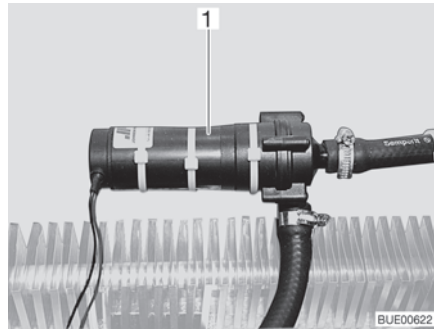

Fig. 141 Auxiliary circulating pump

The auxiliary circulating pump (Fig. 141,1) can be used to heat the vehicle engine when parked.

The auxiliary circulating pump is connected to the vehicle engine's cooling circuit and thus functions as an engine heater.



Fig. 142 Operating switch for auxiliary circulating pump

The auxiliary circulating pump switch (Fig. 142) is located next to the hot-water heater operating unit. The yellow indicator lamp illuminates when the pump is operated.

Filling/emptying the boiler



- ▷ The boiler can be supplied with water from the water tank.
- ▷ Depending on the model, the vehicle is fitted with one or two drain cocks.

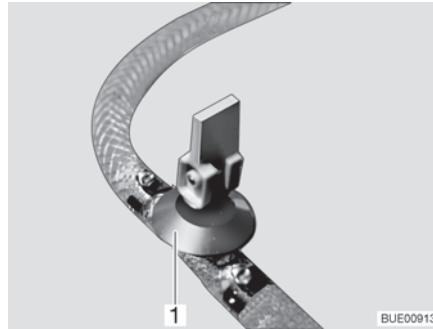

Fig. 143 Drain cock

Filling the boiler with water:

- Close the drain cock(s). Position the rocking lever (Fig. 143,1) horizontally.
- Switch on 12 V power supply on the panel.
- Set all the water taps to "Hot" and open them. The water pump is turned on. The warm water pipes are filled with water.
- Keep the taps open until the water flowing out of the taps has no bubbles in it. This is the only way to ensure that the boiler is full of water.
- Close all water taps.

Emptying the boiler:

- Switch off the boiler.
- Open all water taps and set to the central position.
- Open drain cock(s) (Fig. 143). To do so, set the rocking lever (Fig. 143,1) in a vertical position. The boiler is drained to the outside.
- Check whether the water has been drained completely from the boiler (approx. 10 litres).



- ▷ For further information, see the separate manufacturer's instruction manual and observe the maintenance instructions found in chapter 13.

Position of the drain cock(s)

See chapter 17.

10.2.3 Wall flue

Fresh air and exhaust gases of the heater system are conducted in a two-chamber wall flue.



- ▷ Park the vehicle such that the wall flue gets enough fresh air.
- ▷ The wall flue must be free at all times. Do not cover the wall flue.
- ▷ When camping in winter, maintain wall flue free of snow and ice.
- ▷ Check the wall flue periodically depending on the weather (snow, leaf fall, dirt, etc.). If necessary, clean the wall flue.
- ▷ When washing the vehicle do not aim the water jet directly at the wall flue.
- ▷ When disregarding this, the flawless operation of the heater can not be guaranteed.



Fig. 144 Wall flue (hot-water heater)

The wall flue is mounted on the left side wall.

10.2.4 Electrical floor warming unit (special equipment)



- ▶ On models with electrical floor warming unit, never drill holes in the floor or screw in any screws. Careful with sharp objects. There is danger of a power cut or a short circuit due to damage to a heater wire.



- ▷ Do not cover the transformer. Danger of overheating!



- ▷ The electrical floor warming unit only operates if the vehicle is connected to the 230 V power supply.
- ▷ The output of the electrical floor warming unit alone is not sufficient to heat the living area.

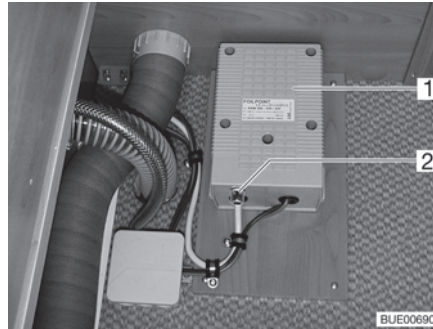

Fig. 145 Transformer for electrical floor warming unit



Fig. 146 Switch for electrical floor warming unit

The transformer (Fig. 145,1) for the electrical floor warming unit is installed either in the bench seat or in the bedding box, depending on the model.

- Switching on:**
- Connect the vehicle to the 230 V power supply (see chapter 9).
 - Press the rocker switch (Fig. 146,2). The indicator lamp (Fig. 146,1) on the switch is illuminated.
- Switching off:**
- Press the rocker switch (Fig. 146,2). The indicator lamp (Fig. 146,1) on the switch goes off.

After switching off, the floor remains warm for a while, due to residual heat. If the transformer is overloaded, the overload protection is actuated. The pin (Fig. 145,2) jumps out.

- Switching on overload protection:**
- Press the pin (Fig. 145,2) on the overload protection when the transformer is cooled.

10.3 Air conditioning unit (special equipment)

10.3.1 Truma Aventa air conditioning unit



- ▷ The cooling circuit may only be opened by the manufacturer or an authorised workshop.
- ▷ Do not block the air inlets and air outlets.
- ▷ Do not drive on any gradients or inclines greater than 8 % when the air conditioning unit is in operation. Otherwise the compressor could be damaged.
- ▷ Do not operate the unit in cooling mode for extended periods when the vehicle is on an incline. Condensation can enter the interior.



- ▷ The air conditioning unit only runs if the vehicle is connected to a 230 V power supply.
- ▷ The external 230 V power supply must be protected by a fuse of at least 6 A. It is otherwise not possible to operate the air conditioning unit properly.
- ▷ Heating at external temperatures below 4 °C is not possible, as the heating output then falls sharply. The unit switches to defrosting for a short time at temperatures between 4 °C and 7 °C. Unrestricted heating operation is possible at external temperatures above 7 °C.
- ▷ Always point the remote control at the infrared receiver when using it.
- ▷ Also read the manufacturer's instruction manual.

Operating modes The air conditioning unit can be operated in the following modes:

- Automatic
- Cooling
- Heater
- Air circulation

Remote control All functions of the air conditioning unit can be operated via the remote control.



- 1 Display
- 2 On/Off button
- 3 Buttons "+" and "-" for temperature selection
- 4 Sliding door for field with setting buttons
- 5 Fan setting selection button (three levels)
- 6 Mode selection button

Fig. 147 Remote control (air conditioning unit)

Automatic mode In automatic mode the desired temperature merely has to be set.

Depending on the room temperature, the air conditioning unit automatically selects cooling or heating mode and the fan setting.

Switching on: ■ Press the On/Off button (Fig. 147,2). The last settings selected are accepted.



▷ The circulation fan runs after switching on. The compressor switches itself on after no more than 3 minutes. The blue LED (cooling) or the yellow LED (heating) flashes.

■ Use the "+" and "-" buttons (Fig. 147,3) to set the desired temperature.

Switching off: ■ Press the On/Off button (Fig. 147,2). The lighting can continue to be operated.

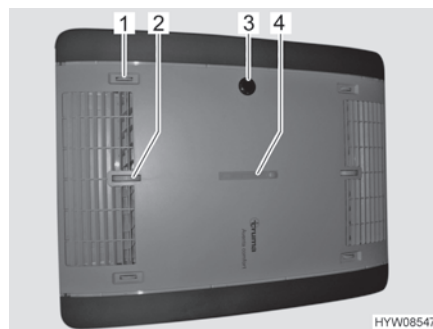

- 1 Air distribution right/left
- 2 Air distribution ceiling/floor
- 3 IR receiver, function display, manual on/off
- 4 Air distribution front/rear

Fig. 148 Function display and air distribution (air conditioning unit)

Operation and display on the unit

Certain functions can be operated directly on the unit.

Air distribution adjustment: ■ Set the small adjustment wheel and sliding regulator for stepless air distribution as desired.

Switching on/off manually: ■ Press the micro button (e.g. with a ballpoint pen if the remote control is not in reach).

Function display

Status LED	Signification
Blue LED flashes	Compressor starts up (cooling mode)
Blue LED lights up	Cooling operation
Yellow LED flashes	Compressor starts up (heating mode)
Yellow LED lights up	Heating mode
Red LED flashes	Data is transferred
Red LED lights up	Fault

Manual mode

In the manual mode, the cooling, heater, and air circulation can be set separately on the remote control.

- Switching on the cooling:**
- Press the On/Off button (Fig. 147,2).
 - Press the mode selection button (Fig. 147,6) until the cooling symbol appears in the display (Fig. 147,1).
 - Use the "+" and "-" buttons (Fig. 147,3) to set the desired temperature.
 - Use the "⌘" selection button (Fig. 147,5) to set the desired fan level.

When the room temperature set on the remote control is reached, the compressor switches itself off and the blue LED in the IR receiver goes out. The circulation fan continues to run.

When the room temperature rises above the set temperature, the unit automatically switches itself back to cooling mode.

- Switching on the heater:**
- Press the On/Off button (Fig. 147,2).
 - Press the mode selection button (Fig. 147,6) until the heating symbol appears in the display (Fig. 147,1).
 - Use the "+" and "-" buttons (Fig. 147,3) to set the desired temperature.
 - Use the "⌘" selection button (Fig. 147,5) to set the desired fan level.

When the room temperature set on the remote control is reached, the compressor switches itself off and the yellow LED in the IR receiver goes out. The circulation fan continues to run.

When the room temperature falls below the set temperature, the unit automatically switches itself back to heating mode.

- Switching on air circulation:**
- Press the On/Off button (Fig. 147,2).
 - Press the mode selection button (Fig. 147,6) until the air circulation symbol appears in the display (Fig. 147,1).
 - Use the "+" and "-" buttons (Fig. 147,3) to set the desired temperature.
 - Use the "⌘" selection button (Fig. 147,5) to set the desired fan level.

In air circulation mode, the inside air is circulated and is cleaned by the filter. No LEDs light up in the IR receiver.

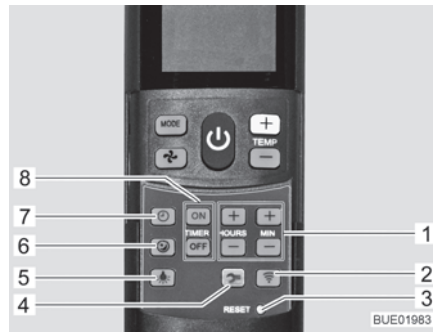

Fig. 149 Remote control with setting buttons (air conditioning unit)

- 1 Buttons for setting the time and the timer
- 2 Send button (repeat data transfer)
- 3 Micro button "RESET" (resetting to the factory setting)
- 4 Setup button for start-up
- 5 Light button (for operating the lighting)
- 6 Soft-start button (for quiet cooling operation)
- 7 Time button (for setting the time)
- 8 "TIMER" buttons for switching time preselection on/off

Activating soft-start: ■ Press the soft-start button (Fig. 149,6). The fan then runs at low speed in cooling mode, which makes it especially quiet.

Setting the time: ■ Press the time button (Fig. 149,7).
 ■ Set the hours and minutes with the buttons (Fig. 149,1).

Switching on the timer: ■ Press the On/Off button (Fig. 147,2).
 ■ Set the desired mode and temperature.

Programming the switching on time: ■ Press "ON" button (Fig. 149,8).
 ■ Press the buttons for setting the time (Fig. 149,1) until the desired time span until switch-on is reached.
 ■ Press "ON" button (Fig. 149,8).

Programming the switch-off time: ■ Press "OFF" button (Fig. 149,8).
 ■ Press the buttons for setting the time (Fig. 149,1) until the desired time span until switch-off is reached.
 ■ Press "OFF" button (Fig. 149,8).

Deactivating the timer: ■ Press the "ON" or "OFF" button (Fig. 149,8) again.

The integrated timer enables the switch-on/switch-off time for the air conditioning unit to be set between 15 minutes and 24 hours in advance (calculated from the current time).

Switching on the lighting: ■ Press the light button (Fig. 149,5). The light is switched on at the last set dimming level.

Dimming the lighting: ■ Press the light button (Fig. 149,5) and keep it pressed until the desired brightness is reached.

Switching off the lighting: ■ Press the light button (Fig. 149,5).



▷ The Setup button (Fig. 149,4) is used to connect the remote control with the air conditioning unit during first set-up.

10.3.2 Telair



- ▷ Always wait at least 2 minutes between switching off and switching on again. Otherwise the compressor will be damaged.
- ▷ If the unit is operating, always open at least one ventilation flap.



- ▷ The air conditioning unit only runs if the vehicle is connected to a 230 V power supply.
- ▷ In the winter, vehicle heating can be supported but not replaced by the air conditioning unit.
- ▷ Following switch-on the air conditioning unit needs approx. 3 minutes until the compressor starts to run and cold air or hot air is output.
- ▷ Also read the manufacturer's instruction manual.

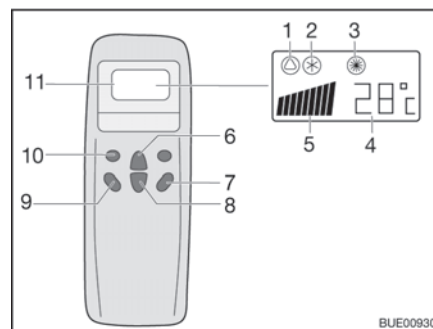

- 1 Symbol for automatic
- 2 Symbol for cooling
- 3 Symbol for heater
- 4 Temperature (set) display
- 5 Fan speed display
- 6 Temperature increase button
- 7 "ON/OFF" button
- 8 Temperature reduction button
- 9 Ventilation speed button
- 10 "Mode" button
- 11 Display

Fig. 150 Remote control

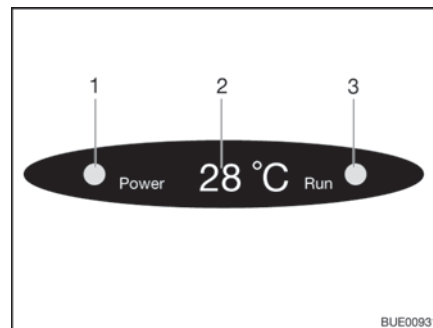

- 1 Mains connection indicator lamp
- 2 Temperature (current) display
- 3 Mode indicator lamp
Green: Cooling
Red: Heater

Fig. 151 Display on the diffuser

To execute the individual switching commands, always point the remote control in the direction of the receiver.

Operating modes

- Automatic
- Cooling
- Heater

Switching on:

- Press the "ON/OFF" button (Fig. 150,7).
- Press the "Mode" button (Fig. 150,10) as often as required until the required operating mode (Fig. 150,1, 2 or 3) is indicated on the display. The corresponding indicator lamp on the diffuser display (Fig. 151,3) lights up.

- Use the temperature increase button (Fig. 150,6) or temperature reduction button (Fig. 150,8) to set the required temperature.
- Use the ventilation speed button (Fig. 150,9) to select the required ventilation level.

Switching off:



- Press the "ON/OFF" button (Fig. 150,7).
- ▷ If the air conditioning unit has run in heating mode, the blower will run on for some minutes in order to dissipate the heat completely.

10.4 Cooker



- ▶ During operation of the gas cooker, do not leave the gas cooker unattended. Even if the gas cooker cannot be overseen for only a short time (e.g. Visit to the toilet), switch the gas cooker off.
- ▶ Never let gas escape unburned due to danger of explosion.
- ▶ Before using the cooker make sure that there is sufficient ventilation. Open windows or the skylight.
- ▶ Do not use gas-operated cooking and baking facilities for heating purposes.
- ▶ Do not fit any curtains in the immediate proximity of the cooker. Fire hazard!
- ▶ Always protect your hands with cooking gloves or potholders when handling hot pots, pans and similar items. There is a risk of injury!

10.4.1 Gas cooker with gas oven and gas grill

Gas cooker



- ▶ During activation and operation of the gas cooker, no flammable objects or highly inflammable objects such as dishcloths, napkins etc. must be near the gas cooker. Fire hazard!
- ▶ The process of ignition must be visible from above and must not be covered by cooking pans placed on the cooker.
- ▶ If the burner flame is accidentally extinguished, turn the control knob to the "0" position and leave the burner off for at least 1 minute. Then ignite it again.
- ▶ If there is a flame protection, always put it up when using the gas cooker.
- ▶ The gas cooker cover is held closed by a spring. When closing there is danger of getting injured!



- ▷ Do not use the glass gas cooker cover as a hob.
- ▷ Do not close the gas cooker cover while the gas cooker is in operation.
- ▷ Do not apply pressure on the gas cooker cover when it is closed.
- ▷ Do not place hot cooking pans on the gas cooker cover.
- ▷ Keep the gas cooker cover open after cooking until the burners are cool. Otherwise the glass plate could shatter.



- ▷ Only use pots and pans whose diameter is appropriate for the gas cooker burners.
- ▷ When the flame goes out, the thermocouple automatically cuts the gas supply.
- ▷ Further information can be obtained from the separate instruction manual "Gas cooker".

The vehicle's kitchen unit is equipped with a 3-burner gas cooker with separate oven and grill.

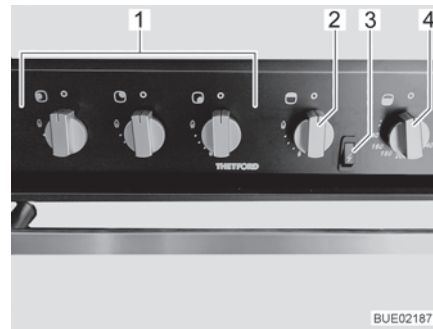

- 1 Control knob for gas cooker
- 2 Control knob for grill
- 3 Lighting knob for grill and oven
- 4 Control knob for oven

Fig. 152 Gas cooker with oven and grill

- Switching on:**
- Open the regulator tap on the gas bottle and the gas isolator tap "Cooker".
 - Open the gas cooker cover.
 - Turn the control knob (Fig. 152,1) of the burner you wish to use to the ignition position (large flame) and press until the flame is burning.
 - Once the flame is burning, the control knob must be held down for 10 to 15 seconds, until the thermocouple automatically keeps the gas supply open.
 - Release the control knob and turn to the desired setting.
 - If ignition is unsuccessful, repeat the entire procedure.

- Switching off:**
- Turn the control knob to the 0-position. The flame fades.
 - Close the gas isolator tap "Cooker" and the regulator tap on the gas bottle.

Gas oven and gas grill

The gas grill is located below the operating controls. The gas oven is located under the gas grill.



- ▶ When the gas oven is in operation, the grill area can also become very hot, even though the gas grill itself is switched off. Never touch hot parts with bare hands.
- ▶ Keep the ventilation openings on the gas oven open at all times.
- ▶ There must be no flammable or highly inflammable objects such as dishcloths, clothes, etc. near the gas oven when it is being lit or during operation. Fire hazard!
- ▶ The oven flap must remain open when it is being lit.
- ▶ When lighting the grill and when grilling, the flap of the gas grill must always remain open.
- ▶ Keep all flammable or highly inflammable objects such as dishcloths, napkins, etc. away from the gas grill during the lighting process and during operation. Fire hazard!



- ▶ If ignition has not taken place, repeat the entire procedure. If necessary, check if there is gas and/or current in the gas oven.
- ▶ If the gas oven still does not work, close the gas isolator tap and notify your service centre.
- ▶ If the burner flame is accidentally extinguished, turn the control knob to the "0" position and leave the burner off for at least 1 minute. Then ignite it again.



- ▷ Before using the gas oven for the first time run it for 30 minutes at maximum temperature without any contents.

Switching on the gas grill:

- Open the regulator tap on the gas bottle and the gas isolator tap "Cooker".
- Open the flap of the gas grill to the fully open position.
- Lightly press the control knob (Fig. 152,2) and turn to lighting position (large flame).
- Press the lighting knob (Fig. 152,3) until there is a flame.
- Once the flame is burning, the control knob must be held down for 10 to 15 seconds, until the thermocouple automatically keeps the gas supply open.
- Release the control knob and turn to the desired setting.
- Leave flap open while grilling.

Switching on the gas oven:

- Open the regulator tap on the gas bottle and the gas isolator tap "Cooker".
- Completely open oven flap.
- Press the control knob (Fig. 152,4) slightly and turn it to an ignition position between 1 and 6.
- Press the lighting knob (Fig. 152,3) until there is a flame.
- Once the flame is burning, the control knob must be held down for 10 to 15 seconds, until the thermocouple automatically keeps the gas supply open.
- Release the control knob and turn to the desired setting.

Switching off the gas oven and gas grill:

- Turn the control knob to the 0-position. The flame fades.
- Close the gas isolator tap "Cooker" and the regulator tap on the gas bottle.

10.4.2 Microwave oven (special equipment)



- ▶ Only qualified personnel may repair the microwave oven. Improper repairs can cause major risks to the user.
- ▶ The protection device against the escape of microwave energy should never be removed.
- ▶ Use the microwave oven only if it has been properly installed.
- ▶ Only use the microwave oven when the door seal is free of damage.
- ▶ Never leave the microwave oven unattended when it is in operation.
- ▶ If there is smoke, keep the microwave oven closed, switch it off and interrupt the power supply.



- ▷ Operate the microwave oven only with the rotary plate and the rotary cross in place.
- ▷ Use only crockery suitable for microwave use.
- ▷ Only operate the microwave with appropriate contents and never run it empty.



- ▷ For cooking times under 2 minutes: First twist the cooking time control knob past "2" and then twist it back to the desired cooking time.
- ▷ Further information can be obtained in the manufacturer's instruction manual.



Fig. 153 Operating controls for microwave oven

- Switching on:**
- Press the key (Fig. 153,3) to open the door and place food into the cooking area.
 - Close the door. A clicking noise can be heard when it engages.
 - Select the output on the control knob (Fig. 153,1).
 - Select the cooking time with the control knob (Fig. 153,2). Cooking begins.

The end of the cooking process is signaled by a signal tone. The microwave oven will switch off automatically.

- Switching off:**
- Press the key (Fig. 153,3) to open the door and take out the food.

10.4.3 Extractor hood (partially special equipment)



Fig. 154 Extractor hood

The cooking area is equipped with an extractor hood. The powerful fan blows the cooking steam directly outside. To switch on the extractor hood, press the right flip switch (Fig. 154,2).

Use the left flip switch (Fig. 154,1) to switch on the two lights in the extractor hood.

10.5 Refrigerator

During the journey, only operate the refrigerator via the 12 V power supply. At high ambient temperatures the refrigerator is unable to reach its full cooling power.



- ▷ When leaving the vehicle, always mount the refrigerator ventilation grill. Otherwise water can enter during rain.
- ▷ The cooling power of the refrigerator depends on the vehicle setup. The cooling power can decrease if the vehicle is inclined by 5° or more. Therefore, always park the vehicle on level ground.
- ▷ Absorption refrigerators operate at normal room temperature (approx. 21 °C) within the specified temperature range. At significantly higher ambient temperatures (> 30 °C), the cooling power is reduced.

10.5.1 Refrigerator ventilation grill

At high external temperatures, the full cooling power of the cooling unit is only guaranteed if the refrigerator is ventilated sufficiently. In order to achieve a better ventilation the refrigerator ventilation grill can be removed.

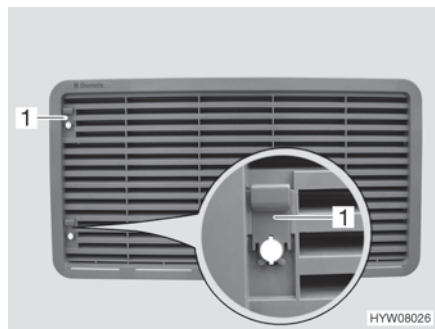

Fig. 155 Refrigerator ventilation grill (with sliding trap)



Fig. 156 Refrigerator ventilation grill (with screw)

- Removing:**
- Depending on version: Push up the sliding trap (Fig. 155,1) or turn the screw (Fig. 156,1) a quarter turn using a coin.
 - Remove refrigerator ventilation grill.

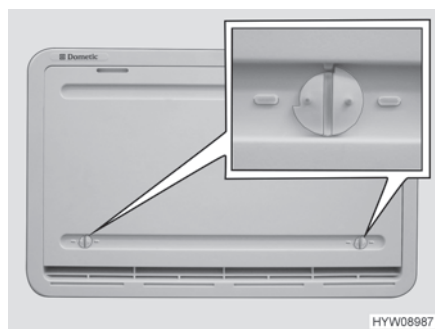

Fig. 157 Winter cover

- Winter cover** If the refrigerator is to be operated at low external temperatures, the manufacturer recommends the use of a winter cover (Fig. 157) for the refrigerator ventilation grills.

The table below shows the temperature ranges in which the winter cover or the insulated winter cover may be used.

Temperature	Cover
Below 10 °C	Winter cover (for refrigerators with capacity below 130 litres: fit only on the lower ventilation grill)
Below -5 °C	Insulated winter cover (fit only on the lower ventilation grill)



▷ If the temperatures are higher than the indicated values, it is absolutely necessary to remove the winter cover. Otherwise the vehicle could be damaged.

- Mounting:**
- Open both locks (Fig. 157) (groove in horizontal position).
 - Put winter cover in front of the ventilation grill.
 - Lock the locks with a small coin (groove in vertical position).

- Removing:**
- Open both locks (Fig. 157) (groove in horizontal position).
 - Remove winter cover from ventilation grill.



▷ The winter cover may remain mounted during the journey.

10.5.2 Dometic MES/AES

Depending on the equipment, different versions of the refrigerator will be installed.

Version MES Manual power selection, automatic ignition

Version AES Automatic and manual power selection, automatic ignition

Operating modes The refrigerator has 3 operating modes:

- 230 V operation
- 12 V operation
- Gas operation



▷ The refrigerator always requires a 12 V control voltage, regardless of which type of energy it is using. The control voltage is present as soon as the transformer/rectifier is switched on. Therefore the closed circuit current always flows even if the refrigerator is switched off. Always switch off the transformer/rectifier for a temporary lay-up.

▷ Close the gas isolator tap "Refrigerator" when the refrigerator is operated electrically.

230 V operation The refrigerator is operated via an external power supply.

12 V operation The refrigerator is operated via the vehicle battery.



▷ In the automatic mode (only AES version), the 12 V operation is only selected, when the vehicle engine is running.

Gas operation

The refrigerator is operated with gas from a connected gas bottle.



▷ If LPG is used, the gas burner must be cleaned more frequently.

Change-over between energy sources

During change-over between the different energy sources, intended delays are installed in the automatic mode (only AES version). This means, that after a change-over to a new energy source the refrigerator can not be operated immediately. When changing from 12 Volt operation to gas operation, the delay is 15 minutes. This prevents a change-over to gas operation when the vehicle is stopped briefly (e.g. stop to fill tank).

Stop to fill tank

▶ Open flames are prohibited at petrol stations.

If the refrigerator was manually set for gas operation during the journey: switch off the refrigerator in the petrol station area or change over to 12 V operation.

If the refrigerator was operated in the automatic mode during the journey (only in the case of the AES version) and the stop for filling the tank takes longer than 15 minutes: switch off the refrigerator. Otherwise, the AES will automatically change over to gas operation 15 minutes after stopping the vehicle engine.

Ignition fuse

When selecting gas operation the ignition fuse is opened automatically so gas can get into the burner. At the same time the electronic ignition is activated. If the gas flame is extinguished, e.g. by blast of wind, the ignition is activated immediately and re-ignites the gas. If there is a fault in gas operation, the illuminated buttons for Gas (Fig. 158,3) and Fault (Fig. 158,9) flash and an alarm sounds for 20 seconds.

Operation

Fig. 158 LED operating panel (Dometic refrigerator)

- 1 On/Off button
- 2 Illuminated button for 230 V mode
- 3 Illuminated button for Gas mode
- 4 Illuminated button for 12 V mode
- 5 Illuminated button for AES operating mode (depending on the model)
- 6 Illuminated button for frame heater (depending on the model)
- 7 Cooling level button
- 8 Cooling level indicator
- 9 Illuminated button for Fault/Reset in gas mode

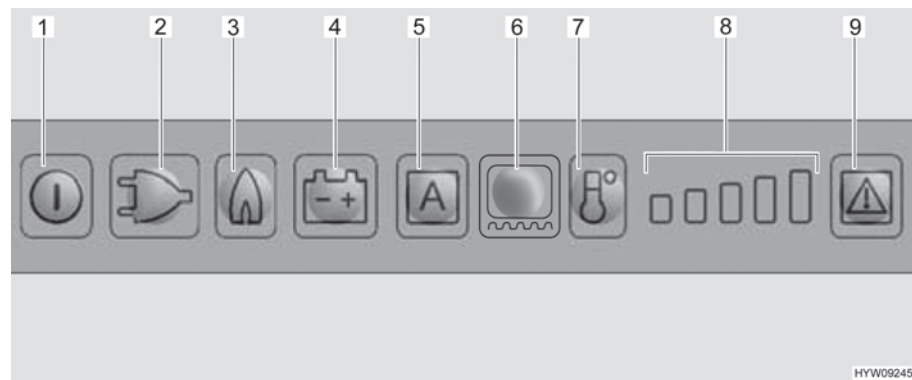

- ▷ If the refrigerator shall be operated with gas: Open the regulator tap on the gas bottle and the gas isolator tap "Refrigerator".

Switching on:

- Press and hold the On/Off button (Fig. 158,1) for about 2 seconds. The refrigerator switches on and the previously set operating mode is displayed.

Selecting operating mode:

- Press the illuminated button for the desired operating mode (Fig. 158,2 - 4) or the automatic mode "AES" (Fig. 158,5) (only in the case of AES version).

In the case of the AES version, the automatic energy selection is carried out in the following order as a function of the availability of the energy sources:

- 12 V solar (special equipment)
- 230 V AC
- 12 V DC
- Gas

Setting the refrigerating temperature:

- Use the cooling level button (Fig. 158,7) to set the refrigerating temperature. The cooling level indicator (Fig. 158,8) shows the selected thermostat setting.

Switching off:

- Press and hold the On/Off button (Fig. 158,1) for about 2 seconds.
- If the refrigerator had been operated with gas: Close the gas isolator tap "Refrigerator" and the regulator tap on the gas bottle.

Refrigerating temperature control

When turned on the first time the refrigerator automatically selects the middle thermostat position. This position can be adjusted manually using the cooling level button (Fig. 158,7). It takes a few hours till the refrigerator reaches its normal operating temperature. When changing over to another operating mode, the thermostat setting is kept.

Frame heater (depending on the model)



- ▷ When the frame heater is turned on, it uses about 4 Watts, including in gas operation. To avoid running down the living area battery, in gas mode refrain from running the frame heater in continuous operation or turn the frame heater off entirely.

The following options are available for operating times of the frame heater:

- 2 hours
- 5 hours
- Continuous operation (switched on for 30 minutes, then for 5 minutes on and 5 minutes off in alternating intervals)

- Setting operating time:
- Switch on the frame heater for a 2 hour period: Push the frame heater illuminated button (Fig. 158,6) once. One bar is lit on the cooling level indicator (Fig. 158,8).
 - Switch on the frame heater for a 5 hour period: Push the frame heater illuminated button (Fig. 158,6) twice. Two bars are lit on the cooling level indicator (Fig. 158,8).
 - Setting frame heater for continuous operation: Push the frame heater illuminated button (Fig. 158,6) three times. Three bars are lit on the cooling level indicator (Fig. 158,8).

The cooling level indicator (Fig. 158,8) shows the operating time of the frame heater for several seconds.

Additional functions

If, after switching on or after setting, no further button is pressed, the brightness of the display is reduced after a few seconds. When pressing a button, the display will light up again. By pressing again, the desired function is activated.

In the automatic mode (only AES version), "AES" and the type of energy currently in use are displayed.

If the refrigerator door remains open for more than 2 minutes, a warning signal sounds.

In the event of a fault, the illuminated Fault button (Fig. 158,9) will flash. Also, either one of the illuminated buttons for operating mode or the cooling level indicator will flash. In addition, a warning signal will sound. For instructions on the display of errors and troubleshooting, see chapter 15.



- ▷ After eliminating a fault of the gas operation, press the illuminated Reset button (Fig. 158,9).
- ▷ Further information can be obtained from the separate instruction manual "Refrigerator".

10.5.3 Refrigerator door locking mechanism

With some models, the refrigerator has a separate freezer compartment. The specifications in this section correspondingly also apply to the door of the freezer compartment.



- ▷ During the journey the refrigerator door must always be closed and locked in the closed position.



- ▷ Lock the refrigerator door in ventilation position when the refrigerator is switched off. This prevents mould forming.

There are two positions for locking the refrigerator door in place:

- Closed refrigerator door during travel and when the refrigerator is in operation
- Slightly opened refrigerator door as a ventilation position when the refrigerator is switched off

Dometic 8 series



Fig. 159 Release button (refrigerator door, Dometic 8 series)

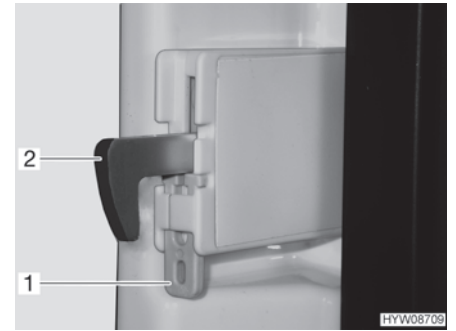

Fig. 160 Fixture (lock hook)

Opening: ■ Press the release button (Fig. 159,1) and open the refrigerator door.

Closing: ■ Close the refrigerator door. The lock hook engages audibly.

When the vehicle has been positioned, the lock hook can be fixed. The refrigerator door can now be opened without having to press the release button.

Fixing the lock hook: ■ Press the fixture (Fig. 160,1) upwards. The lock hook (Fig. 160,2) is pressed upwards and has no function.

Unlocking the lock hook: ■ Push the lock hook (Fig. 160,2) down. The lock hook functions again.

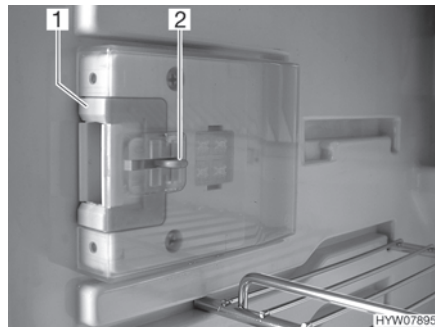

Fig. 161 Locking device (normal position)

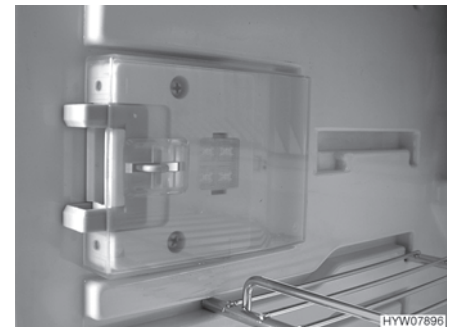

Fig. 162 Locking device (ventilation position)

Locking in the ventilation position:

- Open the refrigerator door.
- Press down the unlocking device (Fig. 161,2).
- Push locking device (Fig. 161,1) forwards (Fig. 162).

If the refrigerator door is closed now, a gap will remain between the refrigerator door and the refrigerator.



Chapter overview

This chapter contains instructions regarding the sanitary fittings of the vehicle.

11.1 Water supply, general



- ▶ Fill water tank from supply systems that have been verified to provide drinking water quality.
- ▶ Only use such hoses or containers when filling that have been approved for use with drinking water.
- ▶ Thoroughly rinse filling hose or container with drinking water before use (2 to 3 times capacity).
- ▶ Empty filling hose or container completely after use and close openings of the filling hose or container.
- ▶ Water left standing in the water tank or in the water pipes becomes undrinkable after a short period. Therefore, before each use of the vehicle, thoroughly clean the water pipes and the water tank. After each use of the vehicle completely empty the water tank and the water pipes.
- ▶ In the case of lay-ups lasting more than a week disinfect the water system before using the vehicle (see chapter 12).



- ▷ If the vehicle is not used for several days or if it is not heated when there is a risk of frost, empty the entire water system. Make certain that the water pump is switched off on the panel. Otherwise, the water pump will overheat and may get damaged. Leave the water taps on in central position. Leave all drain cocks open. Frost damage to appliances, frost damage to the vehicle and deposits in water-carrying components can be avoided in this way.
- ▷ The water pump will overheat without water and can get damaged after one minute at the latest. Never operate water pump when the water tank is empty.

The vehicle is equipped with a fitted water tank. An electric water pump pumps the water to the individual water taps. Opening a water tap automatically switches on the water pump and pumps water to the tap.

The waste water tank collects the waste water. The water level in the water and waste water tanks can be checked on the panel.



- ▷ Before the water fittings can be used, the 12 V power supply and water pump on the panel must be turned on. Otherwise the water pump will not work.
- ▷ When the water tank is re-filled, an air bubble may form at the bottom of the pump. This air bubble will prevent water from being drawn in. Shake the water pump up and down energetically in the water.

11.2 Water system

11.2.1 Water tank



▷ The water tank holds 130 litres. However the volume has been limited to 100 litres (overflow installed) for payload reasons. The panel has not been adjusted to this volume. The level indicator on the panel shows the actual amount of water in the tank.

If necessary or if there is a sufficiently large residual vehicle payload, the water tank can be filled up to its actual capacity. To do this, close overflow. The rotary handle is on the water tank.

11.2.2 Auxiliary water tank (special equipment)

The auxiliary water tank holds 130 l. The auxiliary water tank is installed in the double floor and can be accessed via a side service flap.

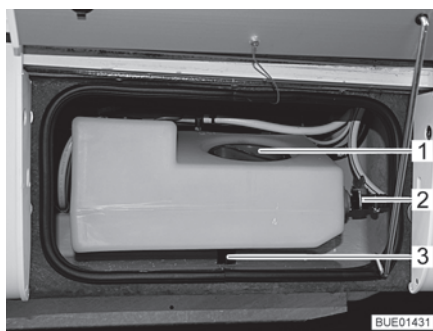

Fig. 163 Auxiliary water tank

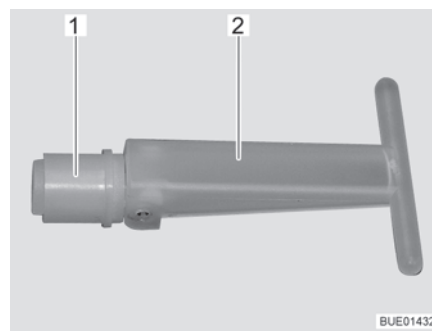

Fig. 164 Stopper

The auxiliary water tank and the water tank are both filled via the drinking water filler neck. Both tanks are connected to each other via a hose.

When the emptying valve (Fig. 163,2) is open, the fill quantity of the auxiliary water tank is limited to approximately 30 litres; excess water will drain off. When the emptying valve is shut, the entire tank volume is available.

When the stopper (Fig. 164,1) is pulled in the inside of the auxiliary water tank, the water drains away via the drain (Fig. 163,3). The stopper can be accessed via the service opening (Fig. 163,1).

- Filling with water:**
- Ensure that the stopper (Fig. 164,1) in the auxiliary water tank is shut (handle (Fig. 164,2) is folded out).
 - Ensure that the emptying valve (Fig. 163,2) is shut.
 - Add water via the drinking water filler neck until both tanks are full.

- Draining water:**
- Open the service opening (Fig. 163,1) in the auxiliary water tank.
 - Open the emptying valve until no more water runs out.
 - Access the handle (Fig. 164,2) of the stopper (Fig. 164,1) via the service opening, turn the handle to the vertical position and remove the stopper.



▷ For reasons of weight it is recommended to empty the auxiliary water tank before commencing the journey.

11.2.3 Drinking water filler neck with cap

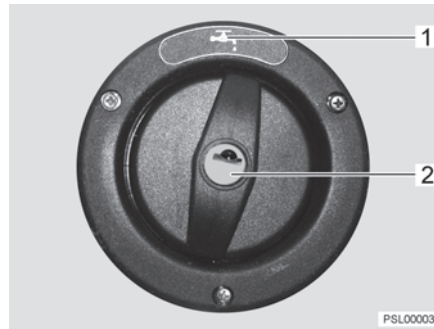

Fig. 165 Cap for the drinking water filler neck

The drinking water filler neck is on the left side of the vehicle.

The drinking water filler neck is indicated by the symbol "🔑" (Fig. 165,1). The cap is open and closed using the key for the external flap locks.

- Opening:**
- Insert key into locking cylinder (Fig. 165,2) and turn a quarter turn in an anticlockwise direction.
 - Remove cap.
- Closing:**
- Place cap on the drinking water filler neck.
 - Turn key one quarter turn in a clockwise direction.
 - Remove the key.
 - Check that the cap sits firmly on the drinking water filler neck.

11.2.4 Filling the water system



- ▶ When filling the water tank, observe the maximum permissible gross weight of the vehicle. Luggage must be reduced accordingly when the water tank is full.



- ▷ The water pump will overheat without water and can get damaged. Never operate water pump when the water tank is empty.



- ▷ Depending on the model, the Alde system (heater/boiler) has one or two drain cocks for emptying.
- ▷ The water quantity can be monitored on the panel while the water tank is filled.

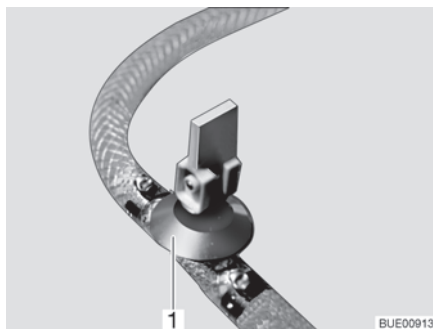

Fig. 166 Drain cock (with rocking lever)

- Position the vehicle horizontally.
- Switch on 12 V power supply on the panel.
- If necessary, switch on the water pump on the panel.
- Clean or disinfect water system.
- Close all drain cocks. In order to do this, position the rocking lever of the drain cock (Fig. 166,1) horizontally.
- Close the drainage opening of the water tank.
- Close all water taps.
- Open the drinking water filler neck on the outside of the vehicle.
- Fill the water tank with drinking water. Use a water hose, a water canister with a funnel or similar for filling.
- Set all the water taps to "Hot" and open them. The water pump is turned on. The warm water pipes are filled with water.
- Keep the taps open until the water flowing out of the taps has no bubbles in it. This is the only way to ensure that the boiler is full of water.
- Set all water taps to "Cold" and leave them open. This will fill the cold water pipes with water.
- Keep the taps open until the water flowing out of the taps has no bubbles in it.
- Close all water taps.
- Close drinking water filler neck.
- Check that the cap on the water tank is not leaking.

Position of the drain cocks and safety/drainage valve

See chapter 17.

11.2.5 Topping up the water



- ▶ When filling the water tank, observe the maximum permissible gross weight of the vehicle. Luggage must be reduced accordingly when the water tank is full.

- Open drinking water filler neck.
- Fill the water tank with drinking water. Use a water hose, a water canister with a funnel or similar for filling.
- Close drinking water filler neck.

11.2.6 Closing/opening the overflow



- ▶ When filling the water tank, observe the maximum permissible gross weight of the vehicle. Luggage must be reduced accordingly when the water tank is full.



Fig. 167 Water tank with rotary handle

- Closing:**
- Turn the rotary handle (Fig. 167,1) on the water tank in a clockwise direction as far as it will go.
 - Fill the water tank with drinking water.
- Opening:**
- Turn the rotary handle (Fig. 167,1) on the water tank in an anticlockwise direction as far as it will go. Excess water will drain away leaving 60 litres in the tank.

11.2.7 Draining water (rotary handle with overflow)



Fig. 168 Water tank with rotary handle

- Turn the rotary handle (Fig. 168,1) on the water tank in an anticlockwise direction as far as possible beyond the resistance to fully open the drainage opening.

11.2.8 Emptying the water system



- ▷ If the vehicle is not used for several days or if it is not heated when there is a risk of frost, empty the entire water system. Make certain that the water pump is switched off on the panel. Otherwise, the water pump will overheat and may get damaged. Leave the water taps on in central position. Leave the safety/drainage valve (if there is one) and all drain cocks open. Frost damage to appliances, frost damage to the vehicle and deposits in water-carrying components can be avoided in this way.
- ▷ If the water pump can be turned off from the panel, always turn off the water pump from the panel before you empty the water system. Otherwise the water pump runs until it overheats or the battery is empty.



- ▷ Take note of the environmental tip in this chapter.



- ▷ Depending on the model, the Alde system (heater/boiler) has one or two drain cocks for emptying.

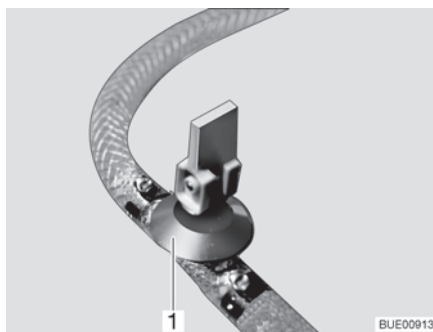

Fig. 169 Drain cock (with rocking lever)

To empty and ventilate the water system, proceed as follows. This will avoid frost damage:

- Position the vehicle horizontally.
- Switch off water pump on panel.
- Switch off the 12 V power supply on the panel.
- Shut off the boiler (see section 10.2.2).
- Open all drain cocks. In order to do this, position the rocking lever of the drain cock (Fig. 169,1) vertically.
- Open the water tank drain.
- Open all water taps and set to the central position.
- Hang the shower handset up in the shower position.
- Unscrew the lock ring on the water tank.
- Take water pump (fitted to the cover) as far as the connecting lines allow.
- Hold the water pump up until the water pipes are completely empty.
- Check whether the water tank is completely empty.
- Set the shower handset down in the shower tray.

- Blow out the remaining water in the water pipes (max. 0.5 bar). In order to do this, remove the water pipe from the water pump and blow into the water pipe in the direction of the appliances.
- Empty the waste water tank. Take note of the environmental tips in this chapter.
- Empty toilet cassette or sewage tank. Take note of the environmental tips in this chapter.
- Clean the water tank and then rinse it out thoroughly.
- Let the water system dry for as long as possible.
- After emptying, leave all water taps on in the central position.
- Leave all drain cocks open.

Position of the drain cocks and safety/drainage valve

See chapter 17.

11.3 Waste water installation



- ▷ Never pour boiling water directly into the sink outlet. Boiling water could cause deformation and leaks in the waste water pipe system.



- ▷ Only empty the waste water tank at disposal stations, camping sites or caravan sites especially provided for this purpose.

11.3.1 Draining waste water

Waste water from the kitchen and washing unit flows through plastic pipes into the waste water tank.

The drain cock and the cleaning opening are located on the underside of the waste water tank.

The waste water tank holds 90 litres.

Drain cock in the vehicle



- ▷ If the living area heater is out of order, the waste water tank no longer is sufficiently protected against frost. Therefore in case of frost, empty the waste water tank and leave the drain cock open or add enough anti-freeze (e.g. kitchen salt) to the waste water tank to prevent the waste water from freezing.

The waste water tank is in the double floor of the vehicle. The waste water tank can be accessed via an external flap or a cover.

The vehicle is equipped with an electrically operated drainage valve.

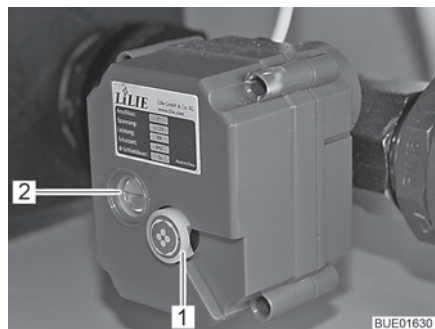

Fig. 170 Electrically operated drainage valve



Fig. 171 Operating switch for electrically operated drainage valve

A red line in the inspection window (Fig. 170,2) of the electrically operated drainage valve shows the valve setting:

- horizontal line = valve open
- vertical line = valve shut

Emptying:

- Attach the waste water hose to the drain pipe.
- Press the operating switch (Fig. 171) at the top. The waste water is drained.
- Completely empty waste water tank.
- Once all the waste water has drained completely, press the operating switch (Fig. 171) at the bottom.
- Remove the waste water hose.

Emergency drainage:

- Set the operating switch (Fig. 171) to the "0" position (power off).
- Pull out the rotary knob (Fig. 170,1) on the electrically operated drainage valve and rotate (in any direction).

11.3.2 Heater for waste water tank and waste water pipes (special equipment)

In order to prevent waste water fittings freezing up, the waste water tank and the waste water pipes can be electrically heated separately.



- ▷ The heater for the waste water system requires up to 250 W for operation. Therefore, wherever possible, connect the vehicle to a 230 V power supply while the heater for the waste water system is working.

The waste water heating continues to function even if the 12 V power supply is switched off on the panel.

In order to prevent the waste water installation from freezing, depending on the model and the equipment, the following components of the waste water system can be heated electrically:

- Waste water tank
- Waste water pipes
- Waste water tank and drainage

When the respective heater has been switched on, temperature sensors monitor the temperature of the waste water tank and the waste water pipes. If there is a risk of frost, the heating elements are switched on. If the temperature rises above a pre-set value, the heating elements are switched off again.



Fig. 172 Switch for waste water heating

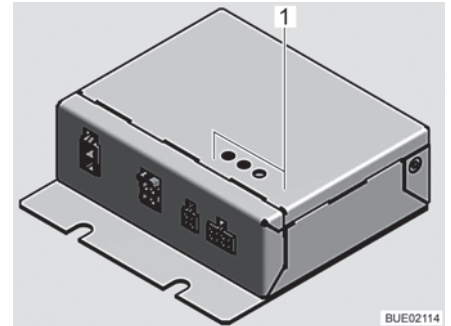

Fig. 173 Control unit for waste water heating

Switching on: ■ Press the upper part of the switch (Fig. 172). The waste water heating is switched on and prevents the heated components from freezing.

Switching off: ■ Press the lower part of the switch.

Three LEDs (Fig. 173,1) indicate the status of the control unit for the waste water heating:

LED HK 1 is lit	Heating circuit 1 is active
LED HK 2 is lit	Heating circuit 2 is active
LED HK 2 is flashing every 16 seconds	The device is in the power saving mode
LED ERR is flashing	The control has detected an error. Contact customer service

11.4 Toilet compartment



▷ Do not transport any loads in the shower tray. The shower tray or other items of equipment in the toilet compartment can be damaged.



- ▷ For ventilation purposes during or after a shower, and for drying wet clothing, close the toilet compartment door and open the window or the toilet compartment skylight. This improves the air circulation.
- ▷ Close the shower curtain completely when showering, so that no water is able to enter the area between the wash room wall and the shower tray.
- ▷ After taking a shower, rinse soap residue from the shower tray, otherwise cracks can appear in the shower tray over time.
- ▷ After using the shower, wipe it dry to prevent moisture from collecting.
- ▷ Further information about cleaning the toilet compartment can be found in the section 12.2.

11.5 Toilet



- ▷ If there is any risk of frost and the vehicle is not heated, empty the sewage tank (cassette).
- ▷ Do not sit on the lid of the toilet. The lid is not designed to bear the weight of a person and could break.
- ▷ Use a suitable chemical for this toilet. The ventilation will merely remove the odour but not germs and gases. Germs and gases will have a detrimental effect on the sealing rubbers.
- ▷ Never put the sanitary liquid directly in the toilet bowl.
- ▷ Do not drive when the sewage tank (cassette) is more than three-quarters full, as otherwise liquid may leak from the sewage tank through the ventilation system.



- ▷ The sewage tank (cassette) can only be taken out if the sliding trap is closed.
- ▷ Further information can be obtained in the device manufacturer's instruction manual.



- ▷ Only empty the sewage tank (cassette) at disposal stations, at camping sites or caravan sites, that are especially provided for this purpose.

The flushing of the toilet is fed directly from the water system of the vehicle.

11.5.1 Preparing toilet



- ▷ The sewage tank (cassette) can only be taken out if the sliding trap is closed.



Fig. 174 Flap for sewage tank



Fig. 175 Sewage tank (example)

- Open the flap for the sewage tank on the outside of the vehicle. Insert the key into the locking cylinder of the push-button lock (Fig. 174,1) and turn a quarter turn.
- Remove the key.
- Press both push-button locks (Fig. 174,2) simultaneously with your thumb and open the flap.
- Pull up the retaining clip (Fig. 175,1) and lift the sewage tank (Fig. 175,2) straight up as far as it will go.
- Tilt the sewage tank slightly and remove fully.

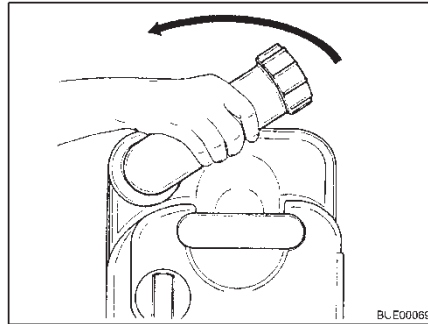

Fig. 176 Turning drainage neck

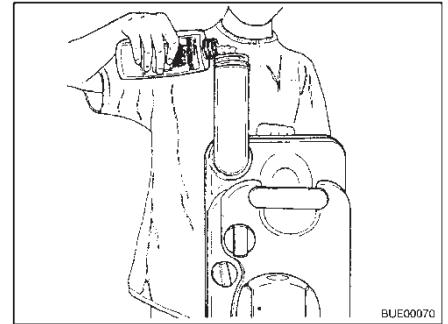

Fig. 177 Filling with sanitary liquid

- Put the sewage tank down vertically.
- Turn the drainage neck upwards (Fig. 176).
- Remove the cap of the drainage neck.
- Fill the stated amount of sanitary liquid into the sewage tank (Fig. 177).
- Then add enough water so that the bottom of the sewage tank is completely covered.
- Close drainage neck with the cap.
- Return the drainage neck to its original position.
- Push the sewage tank back to its original position without applying any force.
- Ensure that the sewage tank is secured by the retaining clip.
- Lock the flap for the sewage tank.

11.5.2 Swivel toilet

The flushing of the Thetford toilet is fed directly from the water system of the vehicle. The toilet bowl can be moved into the optimal position.

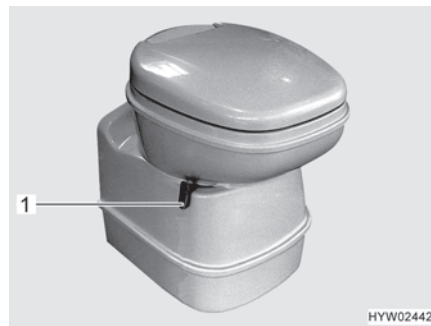

Fig. 178 Thetford toilet bowl, swivelling

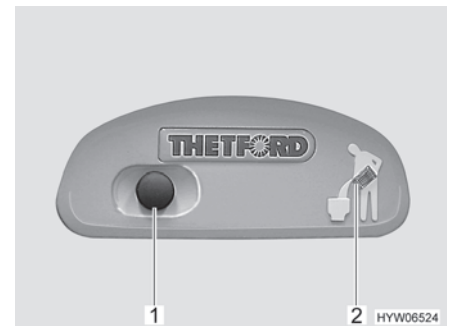

Fig. 179 Flush button/indicator lamp Thetford toilet

- Flushing:**
- Before flushing open the sliding trap of the Thetford toilet. To do this, push the slide lever (Fig. 178,1) in an anticlockwise direction.
 - For flushing, press the blue flush button (Fig. 179,1).
 - After flushing close the sliding trap. To do this push the slide lever in a clockwise direction.

The indicator lamp (Fig. 179,2) goes on whenever the Thetford cassette has to be emptied.

11.5.3 Emptying the sewage tank



▷ The sewage tank can only be taken out if the sliding trap is closed.



Fig. 180 Flap for the sewage tank



Fig. 181 Sewage tank

- Slide the slide lever on the toilet bowl in a clockwise direction. The sliding trap is closed.
- Open the flap for the sewage tank on the outside of the vehicle. Insert the key into the locking cylinder of the push-button lock (Fig. 180,1) and turn a quarter turn in a clockwise direction.
- Remove the key.
- Press both push-button locks (Fig. 180,2) simultaneously with your thumb and open the flap for the sewage tank.
- Pull the retaining clip (Fig. 181,1) upwards and pull out the sewage tank (Fig. 181,2).
- Completely empty the sewage tank at disposal stations that are especially provided for this purpose.



▷ Actuate the aeration knob on the sewage tank with your thumb to empty it completely.

Chapter overview

This chapter contains instructions regarding the care of the vehicle.

At the end of the chapter there is a checklist of measures you must carry out if you are not going to use the vehicle for an extended period of time.

The checklist address the following topics:

- temporary lay-up
- winter lay-up
- start-up after a lay-up

12.1 External care

12.1.1 General

Standard external care consists of regular washing. The use and the environmental conditions will determine how often the vehicle needs to be washed. Wash the vehicle more frequently in areas which are exposed to heavy air pollution or heavy traffic or roads treated with de-icing salts. If the vehicle is exposed to salty and humid air (coastal areas, humid climates), wash the vehicle more frequently.

Do not park under trees if at all possible. The resin-like discharge which many trees secrete, give the paintwork a matt look and can promote the onset of corrosion.

Wash off bird droppings straight away and thoroughly, as the acid it contains is extremely corrosive.

12.1.2 Washing with a high-pressure cleaner



- ▷ Do not clean the tyres with a high-pressure cleaner. The tyres might be damaged.
- ▷ Do not spray external applications (deco-films) directly with the high-pressure cleaner. The external applications could come off.

Before cleaning the vehicle with a high-pressure cleaner, observe the operating instructions of the high-pressure cleaner.

When cleaning with the nozzle for circular jet between the vehicle and the cleaning nozzle, maintain a minimum distance of approx. 700 mm.

Take into consideration that the jet of water comes out of the cleaning nozzle with pressure. The vehicle may be damaged by incorrect handling of the high-pressure cleaner. The temperature of the water should not be above 60 °C. Keep the jet of water in constant movement during the washing process. Do not direct the water jet at clearances, built-in electrical parts, plugs, seals, the ventilation grill or the skylights. The vehicle may be damaged or water may enter the interior.

12.1.3 Washing the vehicle



- ▷ Never clean the vehicle in the car wash. Water can penetrate the refrigerator grills, the waste gas vent or the forced ventilations. The vehicle could be damaged.
- Wash the vehicle only on a washing site intended for this purpose. Avoid full sunshine. Observe environmental measures.
- Only clean external applications and synthetic parts with plenty of warm water, dish washing liquid and soft cloth.
- Wash down the vehicle with plenty of water, a clean sponge or a soft brush. In the case of stubborn dirt add dish washing liquid to the water.
- Painted exterior walls may also be cleaned with a caravan cleaner.
- Add-on parts made of glass-fibre reinforced plastic (GRP) require a regular follow-up treatment with a polisher. This way these parts will not turn yellow and the sealing of the surface remains intact.
- Rub a conventional rubber care product onto the rubber seals on doors and storage flaps.
- Treat locking cylinder of doors and storage flaps with graphite dust.

12.1.4 Windows of acrylic glass



Acrylic glass windows are delicate and require very careful handling.

- ▷ Never rub acrylic glass windows dry as dust particles might damage the surface!
- ▷ Only clean acrylic glass windows with plenty of warm water, some dish washing liquid and a soft cloth.
- ▷ Never use glass cleaning agents with chemical, abrasive or alcohol-containing additives. Premature brittleness of the panes and associated cracks may result from their use.
- ▷ Avoid contact of cleansing agents used for the body (e.g. tar- or silicone-removing agents) with acrylic glass.
- ▷ Do not clean vehicle in car wash.
- ▷ Do not attach stickers to the acrylic glass windows.
- ▷ Having cleaned the vehicle rinse acrylic glass with sufficient clear water.
- ▷ Treat rubber seals with a conventional rubber care product.



- ▷ An acrylic glass cleanser with antistatic effect is suitable for a follow-up treatment. Small scratches can be treated with an acrylic glass polish. These agents are available at the accessories shop.

12.1.5 Entrance step

If the entrance step is lubricated, coarse particles of dirt can settle on the lubricant during the journey and cause damage to the operating mechanism of the entrance step. Therefore, do not lubricate the moving parts of the entrance step.

12.1.6 Air suspension



- ▷ Never clean the individual parts of the air suspension with steam or high-pressure cleaners, abrasive or organic solvents.

Clean the air suspension bellows, air duct and shock absorber regularly. Use soapy water, methanol, ethanol or isopropyl alcohol for cleaning.

12.2 Interior care



- ▷ If possible, treat stains immediately.
- ▷ Acrylic glass windows are delicate and require very careful handling (see section 12.1.4).
- ▷ Synthetic parts in the toilet and living area are very delicate and should be treated with care. Do not use solvents, alcohol-containing cleansers or scourers. This procedure will help you to avoid brittleness and formation of cracks.
- ▷ Hair colourants, nail varnish, cigarette ash and similar substances may cause permanent stains or discolouration. For this reason, you should prevent these substances from getting onto plastic parts. If they do get onto plastic parts, you should remove these substances immediately.
- ▷ Do not pour any corrosive agents into the drain holes. Never pour boiling water directly into the drain holes. Corrosive agents and boiling water cause damage to drainage pipes and siphon traps.
- ▷ Do not use vinegar based products to clean the toilet and water system, or for decalcification of the water system. Vinegar-based products may cause damage to seals or parts of the installation. Use standard decalcifying products for decalcification.
- ▷ Save water. Mop up all remaining water.
- ▷ Vacuum off carpets and cushions with a suitable brush attachment.



- ▷ For information about the use of maintenance products, our representatives and service centres will be glad to advise.
- Surface and knobs of furniture, lamps and synthetic parts in the toilet and living area should be cleaned with water and a wool cloth. A mild cleanser may be added to the water. If required, use furniture polish for the painted surfaces.
- Clean upholstery with dry foam specially manufactured for the use on upholstery or with the foam of a mild detergent. Do not wash upholstery. Always have it cleaned. Protect upholstery from direct sunlight so that it does not lose its colour.
- Leather covers should be cleaned with a cotton cloth and a mild soap (curd soap). Make sure that the leather is not soaked through and that no water seeps through the seams of the leather covers.
- Wash panel curtains and gathered blinds. When washing observe washing instructions on the product. The sticks may be removed for washing.
- Vacuum clean the carpet, if necessary clean with carpet shampoo.

- Clean PVC-floor covering with a mild, soapy cleanser for PVC floors. Do not place carpet on wet PVC-floor covering. The carpet and the PVC-floor covering may stick together.
- Never clean the sink or the gas cooker with a scourer. Avoid anything which may cause scratching or grooves.
- Clean the burners on the gas cooker using a damp cloth only. Prevent any water from penetrating the burner covers. Water may damage the burners on the gas cooker.
- Brush insect screens on doors, windows and skylights with a soft brush or vacuum with the brush attachment of the vacuum cleaner.
- Brush blinds with a soft brush or vacuum with the brush attachment of the vacuum cleaner. Grease or stubborn dirt may be removed with a mild soap at 30 °C (curd soap).
- Brush Roman shades with a soft brush or vacuum with the brush attachment of the vacuum cleaner. Grease or stubborn dirt may be removed with a mild soap at 30 °C (curd soap).
- Unrolled seat belts can be cleaned with warm soapsuds. The seat belt must be completely dry before being rolled up.

12.2.1 Scratch-resistant surface (kitchen worktop and table top) (special equipment)



- ▷ Do not use any cleaning agents with abrasives.
- ▷ Do not use any sponges with abrasive material.
- ▷ Do not use any steel wool.
- ▷ Do not use any cleaning agents with high acid content.
- ▷ Do not use any furniture polish nor any cleaning agent based on wax.
- Wipe the surface with a damp cloth.
- In the case of heavy soiling, wipe the surface with an of-the-shelf cleaner, glass cleaner, dirt eraser, or disinfectant.
- Remove adhesive, dried up bio-waste, chewing gum with sponge, hot water, and household cleaner.
- Remove hairspray, cooking oil, wax, ball pen ink, make-up, nail varnish, marker pens (Edding) with a cloth moistened with alcohol or acetone.
- Remove oil paints with a cloth moistened with paint thinner.
- For descaling use a cleaning agent that contains no more than 10 % acetic or citric acid.
- Remove minor scratches with a dirt eraser.
- Cover deeper scratches with moist kitchen paper. Using an iron set to level II, iron the scratcher in circular motion for no more than 20 seconds. Using a lint-free cloth, rub the scratch in circular motion.

12.3 Water system

12.3.1 Cleaning the water tank

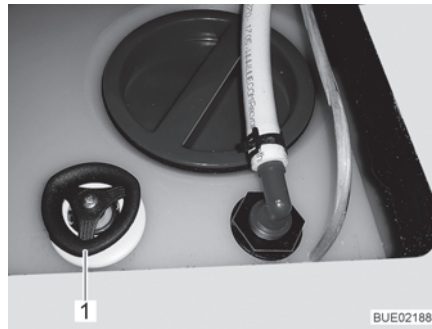

Fig. 182 Water tank with rotary handle

- Empty the water tank and close the drainage opening.
- Remove the cap (Fig. 182,1) of the water tank.
- Fill water tank with water and some washing-up liquid (do not use any scourers).
- Using a trade standard brush for washing dishes, scrub the water tank until there is no longer any visible deposit.
- If possible, clean fresh water sensors through the cleaning openings by hand.
- Rinse water tank with copious amounts of drinking water.

12.3.2 Cleaning the water pipes



- ▷ Only use suitable cleaning agents as sold by the specialist trade.
- ▷ The cleaning agent must meet national regulations and be approved (if required).



- ▷ Collect any emerging mixture of water and cleaning agent for correct disposal.

- Empty the water system.
- Close all drainage openings and drain cocks.
- Fill mixture of water and cleaning agent into the water tank. Observe the manufacturer's instructions regarding the mixing ratio.
- Open the drain cocks one by one.
- Leave the drain cocks open until the mixture of water and cleaning agent has reached the respective drain.
- Close the drain cocks.
- Set all the water taps to "Hot" and open them.
- Leave the water taps open until the mixture of water and cleaning agent has reached the drain.
- Set all water taps to "Cold" and open them.
- Leave the water taps open until the mixture of water and cleaning agent has reached the drain.
- Close all water taps.

- Flush the toilet several times.
- Allow the cleaning agent to act in accordance with the manufacturer's instructions.
- Empty the water system. Collect the mixture of water and cleaning agent for correct disposal.
- For rinsing fill the entire water system with drinking water and empty again several times over.

12.3.3 Disinfecting the water system



- ▷ Only use suitable disinfectants as sold by the specialist trade.
- ▷ The disinfectant must meet national regulations and be approved (if required).



- ▷ Collect any emerging mixture of water and disinfectant for correct disposal.

When disinfecting the water system, proceed the same way as when cleaning the water pipes (see section 12.3.2). Simply use disinfectant instead of cleaning agent.

12.3.4 Cleaning the waste water tank

Clean the waste water tank after every use.

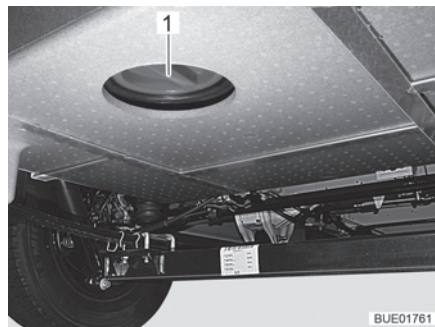

Fig. 183 Cleaning opening of the waste water tank

- Empty the waste water tank.
- Open the cleaning opening (Fig. 183,1) on the waste water tank and the drain cock.
- Thoroughly rinse out the waste water tank with fresh water.
- If possible, clean waste water sensors through the cleaning opening by hand.

12.4 Extractor hood

Clean the extractor hood filter occasionally. How often cleaning is necessary depends on how often the extractor hood is used. Do not wait to clean the filter until the performance of the extractor hood has noticeably decreased.

Cleaning the filter: ■ Wash the filter with warm water and some washing-up liquid.

12.5 Air conditioning unit

12.5.1 Truma



- ▷ Do not clean the air conditioning unit with a high-pressure cleaner. Water entering can damage the air conditioning unit.
- ▷ Do not clean vehicle in car wash.
- ▷ Do not use any sharp or hard objects when cleaning. Otherwise the air conditioning unit could be damaged.

- Use only water and a gentle cleaning agent to clean the air conditioning unit.
- Wipe the air conditioning unit housing and the air outlet occasionally with a damp cloth.
- Clean the remote control occasionally with a slightly damp cloth. Clean the display with a spectacles cleaning cloth.
- Remove leaves and other dirt from the ventilation openings on the air conditioning unit regularly.
- Check the condensation drain holes regularly to ascertain whether the condensation can run off freely.
- Clean the filters on both sides of the air discharge unit regularly.



- ▷ Further information can be obtained in the manufacturer's instruction manual.

12.5.2 Telair

Every now and then clean the filter and the ventilation grilles on the outside of the housing. How often cleaning is necessary depends on how often the air conditioning unit is used. Do not wait to clean the filter and the ventilation grill until the performance of the air conditioning unit has noticeably decreased.



- ▷ Only use mild cleaning solutions to clean the filter, never use benzene or solvents.

Cleaning the filter: ■ Wash the filter with warm water and some washing-up liquid.
 ■ Allow the filter to dry thoroughly before reassembly.

Cleaning the ventilation grill: ■ Use a brush to remove coarse dirt or deposits from the external ventilation grilles. If a cleaning solution is used, ensure that no water ingresses into the inside of the housing.

12.6 Winter care

De-icing salt damages the underbody and the parts open to water spray. We recommend that you wash the vehicle more frequently during wintertime. Mechanical and surface treated parts and the underside are under particular strain, and should therefore be cleaned thoroughly.



- ▷ If there is any risk of frost, always run heater at a minimum of 15 °C. Switch the circulation fan (if there is one) to automatic. In the case of extreme external temperatures, the furniture flaps and doors should be left slightly open. The inflowing warm air can help prevent the freezing of water pipes, for example, and counteract the formation of condensation in the storage spaces.
- ▷ If there is any risk of frost, cover the outside surface of the windows with winter insulation mats.
- ▷ Keep waste gas vents and forced ventilations free of snow. Use a vent extension, if necessary.

12.6.1 Preparations

- Check the vehicle for paint and rust damage. Repair damage as necessary.
- Make certain that water cannot penetrate the automatic floor ventilation system and the heater.
- Use a wax-based rust inhibitor to protect the metal parts of the underbody.
- Use appropriate protection for external painted surfaces.

12.6.2 Winter operation

During winter operation, condensation develops when the vehicle is occupied under low-temperature conditions. To ensure good interior air quality and avoid vehicle damage from condensation, sufficient ventilation is essential.

- When heating the vehicle, the heater should be at the highest setting and roof storage cabinets, curtains and blinds should be opened. This ensures optimal ventilation.
- Only heat if the circulation system is switched on.
- In the morning, lift up all cushions, air out storage boxes and dry any damp areas.



- ▷ If condensation has still developed, just wipe it off.
- ▷ It is only possible to guarantee unrestricted operation during winter for models without double floor in connection with the "winter package" from the original equipment.

12.6.3 At the end of the winter season

- Thoroughly clean the underbody of the vehicle and the engine. When this is done, corrosion-inducing anti-freeze agents (salts, alkaline residues) are removed.
- Clean the exterior and use regular car wax to protect metal surfaces.

12.7 Lay-up

12.7.1 Temporary lay-up



- ▶ If the vehicle has been stationary for a long period (approx. 10 months) have the braking and gas systems checked by an authorised specialist workshop.
- ▶ Take into consideration that water is undrinkable after only a short time.
- ▶ Animal damage to cables can lead to short circuits. Fire hazard!

Before laying up the vehicle, go through the following checklist:

	Activities	Done
Base vehicle	Completely fill fuel tank. This prevents corrosion damage within the fuel tank system	
	Jack up vehicle so that the wheels do not bear any load, or move vehicle every 4 weeks. This prevents any pressure points from occurring on tyres and wheel bearings	
	Protect the tyres from direct exposure to the sun. Danger of formation of cracks!	
	Inflate tyres up to the recommended maximum pressure	
	Always provide for sufficient ventilation in the underbody area	
	 ▷ Humidity or lack of oxygen e.g. by covering with plastic film may cause optical irregularities to the underbody.	
	In addition observe the notes in the operating manual of the base vehicle	
Body	All vents should be sealed with the appropriate caps and all other openings (apart from forced ventilations) should also be sealed. This prevents animals (e.g. mice) from gaining entry	
	Air the interior, all storage spaces accessible from the outside, and the parking space (e.g. garage) every 3 weeks in order to prevent the occurrence of condensation and resulting mould formation	
Interior	Place upholstery in an upright position for ventilation, and cover	
	Clean refrigerator	
	Allow refrigerator and freezer compartment doors to remain slightly open	
	Search for traces of animals that have gained entry	
	Disconnect the flat screen from the mains and, if necessary, remove it from the vehicle	
Gas system	Close regulator tap on the gas bottle	
	Close all gas isolator taps	
	Always remove gas bottles from the gas bottle compartment, even if they are empty	

	Activities	Done
Electrical system	Fully charge living area and starter battery  ▷ Charge the battery for at least 20 hours before laying up.	
	Disconnect the living area battery from the 12 V power supply. In order to do this switch off the battery cut-off switch on the transformer/rectifier or activate the battery separation via the panel (see chapter 9)	
Water system	Empty the entire water system. Blow out the residual water from the water pipes (0.5 bar max.). Leave the water taps on in central position. Leave the safety/drainage valve (if there is one) and all drain cocks open. Observe the notes in chapter 11	

12.7.2 Winter lay-up

Additional measures are required if laying up the vehicle over winter:

	Activities	Done
Base vehicle	Clean body and underbody thoroughly and spray with hot wax or protect with varnish	
	Fill fuel tank with winter diesel	
	Check antifreeze in the cooling water	
	Rectify damage to the paintwork	
	Fill in washer fluid with frost protection	
Body	Clean vehicle from outside thoroughly	
	Keep the forced ventilation open	
	Clean and grease installed supports	
	Clean and grease all door and flap hinges	
	Brush oil or glycerine on all locking mechanisms	
	Treat all rubber seals with a conventional rubber care product	
Use graphite dust to treat locking cylinders		
Interior	Set up the de-humidifier (granulate)	
	Remove cushions and mattresses from the vehicle and store them in a dry place	
	Air the interior every 3 weeks	
	Empty all cabinets and storage compartments, open flaps, doors and drawers	
	Thoroughly clean the interior	
	If there is a risk of frost, do not leave the flat screen in the vehicle	
Electrical system	Remove the starter battery and the living area battery and store them in a place protected from frost (see chapter 9) or connect the vehicle to a 230 V supply. Before removing, remove the fuses on the living area battery	

	Activities	Done
Water system	Clean the water system using a cleaning agent from a specialised store	
Complete vehicle	Arrange the tarpaulins in such a way that the ventilation openings are not covered, or use porous tarpaulins	

12.7.3 Starting up the vehicle after a temporary lay-up or after lay-up over winter

Go through the following checklist before start-up:

	Activities	Done
Base vehicle	Check the tyre pressure on all tyres Check the tyre pressure of the spare wheel	
Body	Clean the pivot bearing of the entrance step Check the functioning of the fitted supports Check that the doors, windows and skylights are working properly Check that all the external locks are working, such as the storage flaps, the filler neck and the conversion door Remove the cover from the waste gas vent of the heater (if there is one) Remove the winter cover from the refrigerator grills (if there is one)	
Gas system	Put the gas bottles in the gas bottle compartment, tie down and connect to the gas pressure regulator	
Electrical system	Connect to 230 V power supply using the external socket Install the living area battery and starter battery, insert the fuses on the living area battery and fully charge the battery  ▷ Charge the battery for at least 20 hours after lay-up. Connect the living area battery with the 12 V power supply. In order to do this switch on the battery cut-off switch on the transformer/rectifier or deactivate the battery separation via the panel (see chapter 9) Check that the electrical system are working, e.g. interior light, socket and all installed electrical appliances	
Water system	Disinfect water pipes and water tank Check the functionality of the operating lever for the waste water tank Close all drain cocks and water taps Check water system for leaks	
Appliances	Check the function of the appliances	

Chapter overview

This chapter contains instructions about inspection and maintenance work concerning the vehicle.

At the end of the chapter you will find important instructions on how to obtain spare parts.

13.1 Official inspections

Depending on the national legislative provisions, the following official inspections must be carried out periodically:

- Main inspection
- Emissions test
- Inspection of the gas system

The inspection intervals in accordance with the national legislative provisions must be adhered to. The inspection stickers attached to the vehicle indicate when the next inspection is required.



- ▷ Any changes on the gas system must be carried out by an authorised specialist workshop.
- ▷ Even in the case of vehicles that are not registered, an inspection of the gas system is required.

13.2 Inspection work

Like any technical appliance, the vehicle must be inspected at regular intervals.

This inspection work must be carried out by qualified personnel.

Special technical knowledge, which cannot be taught within the framework of this instruction manual, is required for these tasks. Personnel possessing this technical knowledge are available for assistance at all our service centres. Their experience and regular technical instruction by the factory as well as equipment and tools guarantee expert and up-to-date inspection of the vehicle.

Have the "First Programmed Inspection" carried out at one of our service centres 12 months after initial registration.

Further inspections should be carried out once a year.

The service centre in charge will confirm the work performed.

Have chassis inspections confirmed in the chassis manufacturer's customer service booklet.



- ▷ Observe the inspections indicated by the manufacturer and have them carried out at the specified intervals. The value of the vehicle is thus preserved.
- ▷ The confirmation of the inspection work carried out serves as valid proof in the event of damage and guarantee claims.

13.3 Maintenance work

As with every machine, this vehicle requires maintenance. The extent and frequency of the maintenance work required depend on conditions of operation and use. More difficult operating conditions make it necessary to service the vehicle more often.

Have the base vehicle and the appliances serviced at the intervals specified in the corresponding instruction manuals.

13.4 Doors

To maintain gliding capability between springs and hinges, grease the conversion door hinges occasionally.



▷ We recommend either Molykote PG 65 or Vaseline as lubricants.

13.5 Living area battery

Observe the following to extend battery life:

- Keep the battery surface clean and dry.
- Protect the battery poles and the terminals from corrosion.
- Check the charging condition periodically or use a charge conservation device.
- Always keep stored batteries in charged condition and in a cool place.

13.6 Extractor hood

The active carbon filter in the recirculating extractor hood must be replaced with a conventional active carbon filter if necessary.

- Remove the metal grease filter and clean if necessary.
- Remove the active carbon filter.
- Shake the new active carbon filter if necessary, such that the carbon granules are evenly distributed.
- Insert a new active carbon filter.
- Insert the metal grease filter.

13.7 Alde hot-water heater



- ▷ Check the level of the heating fluid regularly on the compensator reservoir.
- ▷ During or after the first operating hours of the hot-water heater, the filling level may fall below the minimum mark. If this is the case, top up the heating fluid.
- ▷ We recommend to bleed the heating system after the initial heater operation and to check the glycol content.



- ▷ Have heating fluid changed by an authorised dealer or a service centre at intervals of approximately two years as corrosion-protection wears off after some time.
- ▷ Top up heating system with a water-glycol mixture (60 : 40) only. This mixture offers frost protection up to approx. -25 °C. When topping up hot-water heaters that are connected to the engine's cooling circuit, please observe the instructions in the instruction manuals of the manufacturers.



- ▷ Further information can be obtained in the device manufacturer's instruction manual.

13.7.1 Checking the fluid level

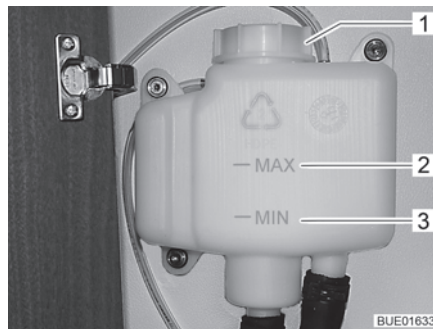

Fig. 184 Compensator reservoir without panel

- Switch off the hot-water heater and allow it to cool down.
- Check if the fluid level is between the marks "MIN" (Fig. 184,3) and "MAX" (Fig. 184,2) on the compensator reservoir (Fig. 184).

13.7.2 Topping up heating fluid

- Position the vehicle horizontally. This prevents the formation of bubbles.
- Switch off the hot-water heater and allow it to cool down.
- If necessary, unscrew or remove the panel (depending on the model).
- Open the rotary lid (Fig. 184,1) on the compensator reservoir.
- Remove cover.
- Check anti-freeze with an anti-freeze hydrometer. The frost protection content must be 40 % or correspond to a frost protection of -25 °C.
- Fill water frost protection mixture slowly into the compensator reservoir.



- ▷ The optimum fluid level is reached when the fluid in the compensator reservoir is 1 cm above the "MIN" mark when it is cooled down.

13.7.3 Bleeding the heating system

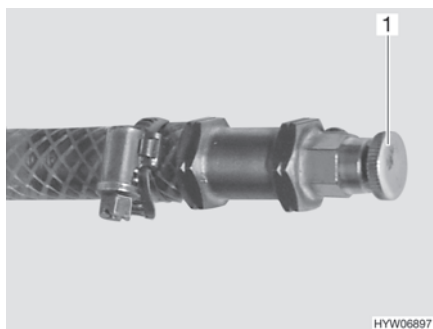

Fig. 185 Bleeding valve of hot-water heater

The bleeding valves are built in nearby the radiators.

For position of the bleeding valves, see also table "Position of the bleeding valves".

- Switch off the hot-water heater and allow it to cool down.
- Open bleeding valve (Fig. 185,1) and leave open until no more air escapes.
- Close bleeding valve.
- Repeat this procedure at all bleeding valves.
- Check to see if the hot-water heater warms up.

13.7.4 Position of the bleeding valves

A 747-2

Position of the bleeding valves	
	Drain for complete emptying under the garage flap under the vehicle at the right
	On the overcab bed, right and left
	In the seating group away from the direction of travel, access via the bench seat cover
	In the divan in the front area, access via the service flap
	In the cabinet at the left access
	In the bathroom on the radiator
	On the rear bed, left and right
	In the kitchen behind the drawer
	In the rear to the right, access via the garage flap

13.8 Replacing bulbs, external



- ▶ Bulbs and light fittings can be extremely hot. Therefore, allow lights to cool down before changing bulbs.
- ▶ Store bulbs in a safe place inaccessible to children.
- ▶ Do not use any bulb that has been dropped or which shows scratches in its glass. The bulb might burst.



- ▷ A new bulb should not be touched with the fingers. Use a cloth when installing the new bulb.
- ▷ Use only bulbs of the same type and with the correct wattage (see section 13.8.4 "Types of bulbs for exterior lighting").
- ▷ If LEDs in lights are defect, contact an authorised dealer or service centre.

Types of bulbs

Different types of bulbs are used in the vehicle. Below, we have described how to change the different types of bulbs.

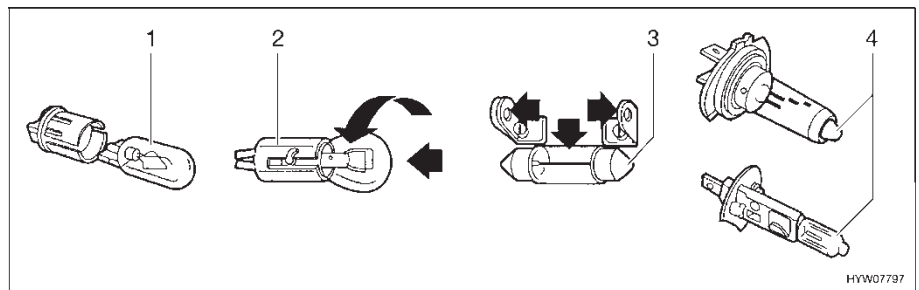

Fig. 186 Types of bulbs

Pos. in Fig. 186	Fixture type/bulb type	Changing
1	Plug-in fixture	To remove, pull out the bulb To mount, push the bulb into the socket with gentle pressure
2	Bayonet socket	To remove, press the bulb down and turn in an anticlockwise direction To insert, place the bulb in the socket and turn in a clockwise direction
3	Cylindrical bulbs	To remove and to insert, carefully bend the contacts of the lamp holder outwards
4	Halogen bulb	To remove, release retaining springs After inserting, hook the retaining springs again

13.8.1 Front lights

The lamps for low beam, main beam and parking light as well as for the direction indicator are part of the basic vehicle. Replacement of light bulbs is described in the instruction manual of the base vehicle.

13.8.2 Rear lights

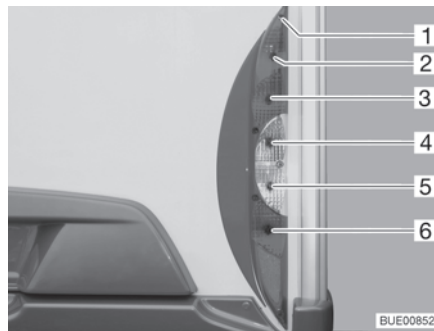

- 1 Housing screws
- 2 Rear light
- 3 Brake light
- 4 Direction indicator
- 5 Reverse light
- 6 Fog tail light

Fig. 187 Rear lights

- Undo the five housing screws (Fig. 187,1).
- Remove housing.
- Remove bulb.
- Put in a new bulb.
- Reassemble the lamp in the reverse order.

13.8.3 Side lights

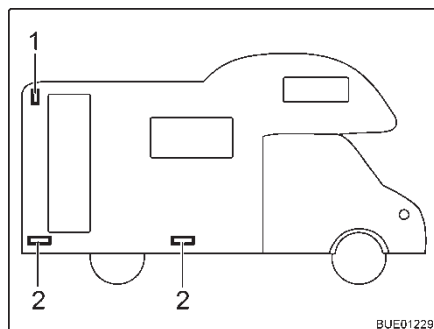

- 1 Side marker light
- 2 Marker light

Fig. 188 Side lights

Side marker light

The side marker light is fixed in the rear area at the top.

Marker lights

The marker lights are fitted in the lower part of the vehicle. Depending on the length of the vehicle, there may be 2 or 3 marker lights.



- ▷ The lights have LEDs. To change the LEDs, contact an authorised dealer or a service centre.

13.8.4 Types of bulbs for exterior lighting

	Exterior lighting	Type of bulb
Rear	Brake light	Ba15s 12 V 21 W
	Rear light	Ba15s 12 V 5 W
	Direction indicator	Ba15s 12 V 21 W orange
	Fog tail light	Ba15s 12 V 21 W
	Licence plate light	LED
	Reverse light	Ba15s 12 V 21 W
	Third brake light	LED
Side	Marker light	LED
	Side marker light	LED

13.9 Replacing bulbs, internal



- ▶ Bulbs and light fittings can be extremely hot. Therefore, allow lights to cool down before changing bulbs.
- ▶ Shut off the power supply on the safety cut-out in the 230 V fuse box before changing bulbs.
- ▶ Store bulbs in a safe place inaccessible to children.
- ▶ Do not use any bulb that has been dropped or which shows scratches in its glass. The bulb might burst.
- ▶ Halogen lamps can get very hot. When the light is switched on, there must always be a safety distance of 30 cm between light and flammable objects. Fire hazard!
- ▶ Do not replace the LEDs in lights with standard light bulbs. Risk of fire due to intense heat build up.



- ▷ A new bulb should not be touched with the fingers. Use a cloth when installing the new bulb.
- ▷ Only use bulbs of the same type and with the correct wattage.
- ▷ If LEDs in lights are defect, contact an authorised dealer or service centre.

13.9.1 Halogen ceiling lamp

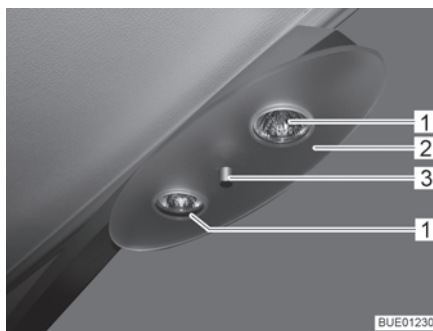

Fig. 189 Halogen ceiling lamp

Halogen bulb 12 V/10 W

- Changing bulbs:
- Unscrew retaining nut (Fig. 189,3) and remove cover plate (Fig. 189,2).
 - Remove halogen bulb (Fig. 189,1).
 - Put in a new halogen bulb.
 - Reassemble the lamp in the reverse order.

13.9.2 Recessed lights with LED

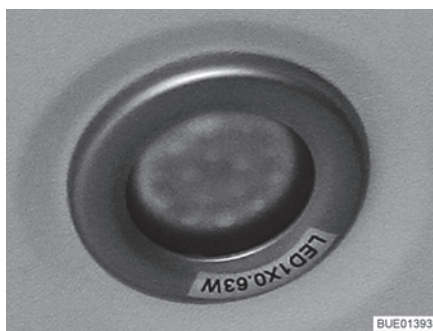

Fig. 190 Recessed LED light



Fig. 191 LED light with switch



- ▷ LED lights have a very long life. It is not normally necessary to replace a light.

- Changing bulbs: ■ Contact a dealer or service centre.

13.9.3 Wardrobe light

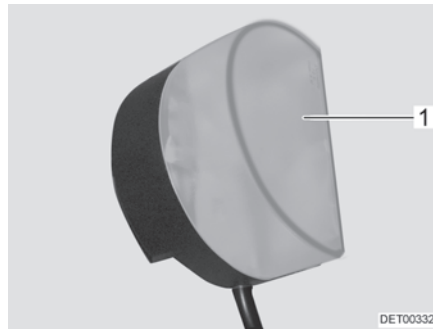

Fig. 192 Wardrobe light

Halogen bulb 12 V/8 W

- Changing bulbs:
- Press the light covering (Fig. 192,1) lightly together and remove it.
 - Remove halogen bulb.
 - Put in a new halogen bulb.
 - Reassemble the lamp in the reverse order.

13.9.4 Surface mounted light

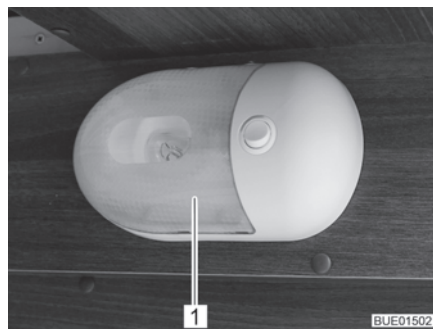

Fig. 193 Surface mounted light

12 V/16 W halogen bulb

- Changing bulbs:
- Carefully push the transparent cover (Fig. 193,1) together from both sides, pull it lightly from the switch and pull it off forwards.
 - Remove halogen bulb.
 - Put in a new halogen bulb.
 - Reassemble the lamp in the reverse order.

13.10 AL-KO rear axle

Fiat vehicles with AL-KO rear axle without air suspension



- ▷ In addition to the regulations and notes in the operator manual of the basic vehicle as well as in the maintenance manual, the rear axles must be relubricated after 20,000 km, or at least every 12 months.
- ▷ The rear axles must not bear any load while they are being lubricated.
- ▷ Use one of the following types of grease for lubrication:
 - Costrac GL 1501 by the firm Klüber
 - Cardex 3746 SP by the firm CONDA



- ▷ If the vehicle is equipped with a maintenance-free torsion bar spring axle or a rear axle with air suspension, the two lubricator nipples are left out.

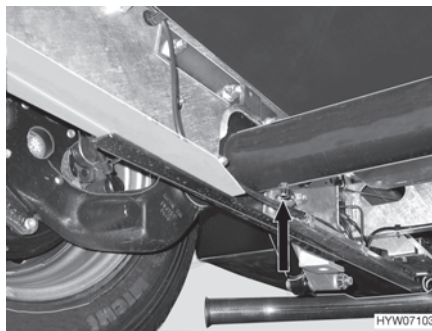

Fig. 194 AL-KO rear axle (Fiat)

The lubricator nipples (Fig. 194, arrow) are situated on the underside of the axle tube.

13.11 Spare parts



- ▶ Every alteration of the original condition of the vehicle can alter road behaviour and jeopardize road safety.
- ▶ The special equipment and original spare parts recommended by us have been specially developed and supplied for your vehicle. These products are available at the authorised dealer or service centre. The authorised dealer or service centre is informed about admissible technical details and carries out the required work correctly.
- ▶ The use of accessories, parts and fittings not supplied by us may cause damage to the vehicle and jeopardize road safety. Even if an expert's report, a general type approval or a design certification exists, there is no guarantee for the proper quality of the product.
- ▶ No liability can be assumed for damage caused by products which have not been released by us. This also applies to impermissible alterations to the vehicle.

For safety reasons, spare parts for pieces of equipment must correspond with manufacturer's instructions and be permitted by the manufacturer as a spare part. These spare parts may only be fitted by the manufacturer or an authorised specialist workshop. The authorised dealers and service centres are available for any spare parts requirement.

Here are some suggestions of important spare parts:

- Fuses
- V-belt
- Windscreen blades
- Bulbs
- Water pump (submerged pump)

When ordering spare parts please indicate the chassis number and the vehicle type to the dealer.

The vehicle described in this instruction manual is built and equipped to factory standards. Special equipment is offered depending on its purpose or use. When fitting special equipment check if such equipment has to be entered in the vehicle documents. Observe the max. permissible gross weight. The authorised dealer or service centre will be happy to advise you.

13.12 Vehicle identification plate

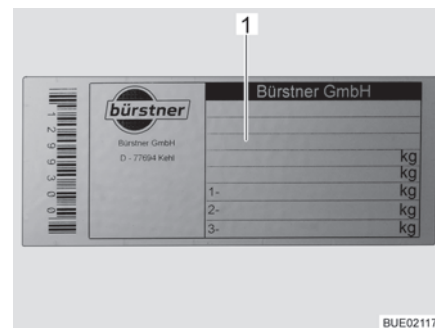

1 Chassis number

Fig. 195 Vehicle identification plate

The vehicle identification plate (Fig. 195) with the chassis number is attached inside, to the B pillar.

Do not remove the vehicle identification plate. The vehicle identification plate:

- Identifies the vehicle
- Helps with the procurement of spare parts
- Together with the vehicle documents identifies the vehicle owner



- ▷ Always include the **chassis number** with all inquiries for the customer service office.

13.13 Warning and information stickers

There are warning and information stickers on and inside the vehicle. Warning and information stickers are for the sake of safety and must not be removed.



- ▷ Replacement stickers can be obtained from an authorised dealer or a service centre.



Chapter overview

This chapter contains instructions regarding the tyres of the vehicle.

At the end of the chapter there is a table you can use to find the correct tyre pressure for your vehicle.

14.1 General



- ▶ Check tyre pressure before a journey or every 2 weeks. Wrong tyre pressure causes excessive wear and can lead to damage or even to tyre burst. You can lose control of the vehicle (see section 14.7).



- ▷ Check the tyre pressure on cold tyres. Do not reduce the higher tyre pressure when the tyres are warm.
- ▷ Tubeless tyres have been installed on the vehicle. Never install tubes in these tyres.
- ▷ Read the instruction manual for the base vehicle.



- ▷ Depending on the model, the vehicle may only be equipped with a tyre repair kit as standard.
- ▷ In the case of a puncture, pull the vehicle over to the side of the road. Make vehicle safe with a hazard warning triangle. Switch on the warning lights.
- ▷ Tyres on vehicles with tandem axles may wear faster.
- ▷ Tyres should not be older than 6 years because the material will become brittle over time. Have the tyres inspected after 6 years. The four-digit DOT number on the tyre flank indicates the date of manufacture. The first two digits designate the week, the last two digits the year of manufacture.

Example: **0718** Week 07, year of manufacture 2018.

Observe:

- Check the tyres regularly (every 2 weeks) for equal tread wear, tread depth and external damage.
- Replace tyres at the latest, when the minimum depth of tread stipulated by law is reached.
- We recommend always using tyres of the same model, same brand and same version (summer and winter tyres).
- Only use tyres approved for the wheel rim type fitted. The permitted rim and tyre sizes are quoted in the vehicle documents and the authorised dealer or service centre will always be glad to give you advice.
- Run-in new tyres for approx. 100 km (60 miles) at low speed since only then do they reach full strength.

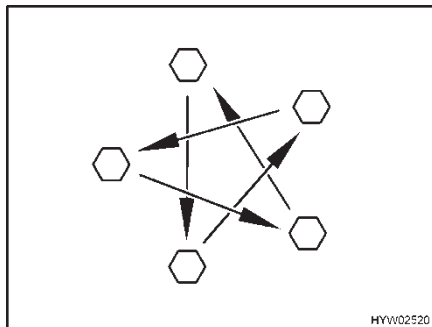

Fig. 196 Tighten the wheel nuts or wheel bolts cross-wise

- Check regularly that the wheel nuts or wheel bolts are firmly seated. Re-tighten the wheel nuts or wheel bolts of a changed wheel after 50 km (30 miles) (Fig. 196). See section 14.5.2 for tightening torque.
- When using new or newly painted wheel rims, re-tighten the wheel nuts or wheel bolts once again after approx. 1,000 to 5,000 km (600 miles to 3,000 miles) (Fig. 196).
- For lay-ups or long periods of inactivity of the vehicle, keep the tyres and tyre bearings free from pressure points: Jack up the vehicle so that the wheels do not bear any load, or move the vehicle every 4 weeks in such a way that the position of the wheels is changed.

14.2 Tyre selection



- ▶ A wrong tyre can damage the tyres during the journey and even cause it to burst.



- ▷ If tyres that are not approved for the vehicle are used, then the type approval for the vehicle and subsequently the insurance coverage can lapse. The authorised dealer or service centre will be happy to advise you.

The tyre sizes approved for the vehicle are given in the vehicle documents or can be obtained from the authorised dealers or service centres. Each tyre must fit the vehicle on which it will be driven. This applies to the external dimensions (diameter, width), which are indicated with the standardised size designations. In addition, the tyres must meet the requirements of the vehicle with regard to weight and speed.

Weight refers to the maximum permissible axle load which can be distributed on two tyres. The maximum load-carrying capacity of a tyre is indicated by its load index (= LI, load index code).

The axle geometry of a vehicle, such as wheel camber and track, is also important for tyre selection. The maximum permissible speed for a tyre (with full load-carrying capacity) is indicated by the speed index (= SI). Together, load index and speed index form the operating code of a tyre. This is an official component of the complete, standardised dimensions description which appears on every tyre. The information on the tyres must correspond to the specifications which appear in the vehicle papers.

14.3 Tyre specifications

215/70 R 15C 109/107
Q (example)

Description	Explanation
215	Tyre width in mm
70	Height-to-width proportion in percent
R	Tyre design (R = radial)
15	Rim diameter in inches
C	Commercial (transporter)
109	Load index code for single tyres
107	Load index code for twin tyres
Q	Speed index (Q = 160 km/h)

14.4 Handling of tyres

- Drive over kerbs at an obtuse angle. Otherwise the flanks of the tyres may get pinched. Driving over a kerb at a sharp angle can damage the tyre and result in it getting ruptured.
- Drive over high manhole covers at a slow speed. Otherwise the tyres may get pinched. Driving over a high manhole cover at high speed can damage the tyre and result in it getting ruptured.
- Check the shock absorbers regularly. Driving with poor shock absorbers significantly increases wear.
- In the event of an uneven thread wear, contact customer service.
- Do not clean the tyres with a high-pressure cleaner. The tyres can suffer serious damage within just a few seconds and rupture as a result.

14.5 Changing wheels

14.5.1 General instructions



- ▶ The vehicle must be on level, firm ground, secure from slipping.
- ▶ Go into first gear. In the case of automatic transmission, change gear to "P" position.
- ▶ Before jacking up the vehicle firmly apply the handbrake.
- ▶ Prevent the vehicle from rolling away by blocking the opposite wheel with the wheel chocks.
- ▶ Under no circumstances jack the vehicle with the fitted supports.
- ▶ If a trailer is connected: Detach the trailer before lifting the vehicle.
- ▶ Position the vehicle jack underneath the axle, not under any circumstances on the bodywork.
- ▶ Never overload the vehicle jack. The maximum permissible load is specified on the vehicle jack's identification plate.
- ▶ Use the vehicle jack only for lifting the vehicle briefly while changing the tyre.
- ▶ No persons may be in the vehicle while it is raised.



- ▶ Do not start the motor while the vehicle is jacked up.
- ▶ Whilst the vehicle is in a jacked up position, persons must not lie down under it.



- ▷ Do not damage the thread of the thread bolt or wheel bolt when changing the wheel.
- ▷ Tighten the wheel nuts or wheel bolts cross-wise (Fig. 196).
- ▷ When changing wheels (e.g. alloy wheel rims or wheels with winter tyres), use the correct wheel bolts of the correct length and shape. Otherwise the wheels may not be securely fixed or the braking system may not work correctly.
- ▷ The use of wheel rims or tyres that are not approved for the vehicle can make it less than fully roadworthy; such wheel rims or tyres must be separately inspected and approved by an accredited test centre.
- ▷ Do not replace wheels cross-wise.



- ▷ Protect the vehicle according to the national regulations, e.g. with a hazard warning triangle.
- ▷ Before changing the wheel, check the wheel rim and tyre size, the max. tyre load and the speed index on the tyres. Only use the wheel rim and tyre sizes stated in the vehicle documents.
- ▷ Further information can be found in the instruction manual of the base vehicle.

14.5.2 Tightening torque

Depending on the wheel rim type and the wheel manufacturer, the wheels must be tightened with different tightening torques.

Steel wheel rims

Description	Tightening torque
16" Fiat X250 Heavy	170 Nm



Fig. 197 Steel wheel rim (standard)

Alloy wheel rims

Description	Tightening torque
16" Fiat X250 Heavy	170 Nm



Fig. 198 Fiat Heavy

14.5.3 Changing a wheel



- ▶ The footplate of the vehicle jack must be levelly positioned on the ground.
- ▶ Do not tilt the vehicle jack.
- ▶ Never apply the handbrake when changing wheels on the rear axle of Model A 747-2. If the handbrake is applied, the vehicle jack could break.



- ▷ The wheel you have replaced should be repaired immediately.
- ▷ Take note of the general instructions in this chapter.



Fig. 199 Securing vehicle

- Park the vehicle on as even and stable a surface as possible.
- Switch off the engine and safeguard the area.
- Engage first gear or reverse gear.
- Apply the handbrake.
- Place wheel chocks or other appropriate objects beneath the opposite wheel of the vehicle to secure it (Fig. 199).
- Remove the spare wheel from the spare wheel support.
- If the ground is soft, place a stable support such as a wooden board beneath the vehicle jack.

- Apply the vehicle jack to the designated mounting points (refer to the instruction manual for the base vehicle).
- Using the wheel brace, turn the wheel bolts several times to loosen them, but do not remove them.
- Lift the vehicle until the wheel has been lifted 2 to 3 cm above the ground.
- Remove the wheel bolts and take off the wheel.
- Place the spare wheel on the wheel hub and adjust.
- Screw in the wheel bolts and slightly tighten them cross-wise.
- Crank down the vehicle jack and remove it.
- Using the wheel brace, tighten the wheel bolts evenly (see section 14.5.2 for tightening torque).
- Have the tightening torque checked by an authorised specialist workshop.

14.6 Spare wheel support under the vehicle (special equipment)

Depending on the model, the spare wheel can be found under the vehicle or in the rear garage.

14.6.1 Spare wheel support under the vehicle (basket)



- ▶ Due to its weight and fitted position, the spare wheel can be raised or lowered by a very strong person only. Always get a second person to assist.

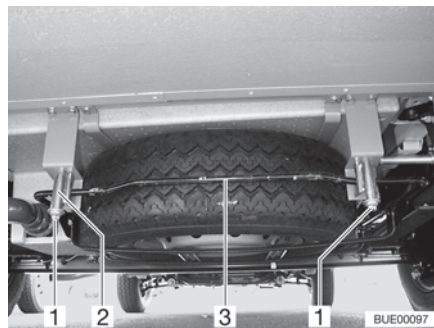

Fig. 200 Spare wheel support (basket)

Removing the spare wheel:

- Loosen the nuts (Fig. 200,1) on the right and left rear hooks (Fig. 200,2) of the spare wheel support.
- Unscrew the wheel nuts approx. 3 to 4 cm.
- Pull the bar (Fig. 200,3) slightly upwards. At the same time, pull down the hooks and unhook the bar.
- Take down the basket and remove the spare wheel.

14.7 Tyre pressure



- ▶ Tyres overheat if the tyre pressure is too low. This can cause serious tyre damage.
- ▶ Check tyre pressure before a journey or every 2 weeks. Wrong tyre pressure causes excessive wear and can lead to damage or even to tyre burst. You can lose control of the vehicle.
- ▶ Use only valves that are approved for the specified tyre pressure.



- ▷ Check the tyre pressure on cold tyres. Do not reduce the higher tyre pressure when the tyres are warm.

The payload and the durability of tyres is directly dependent on the tyre pressure. Air is a volatile medium. It is unavoidable that it will escape from tyres.

As a rule of thumb it can be assumed that a filled tyre loses pressure at a rate of 0.1 bar every two months. To prevent the tyres becoming damaged or burst, check the tyre pressure regularly.

The contact surface of the tyre changes, depending on the tyre pressure.

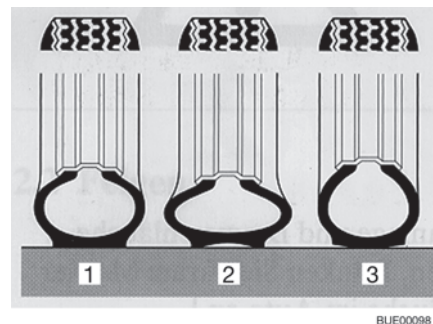

- 1 Correct tyre pressure
- 2 Tyre pressure too low
- 3 Tyre pressure too high

Fig. 201 Contact surface of the tyre



- ▷ The information on pressure levels is valid for cold tyres and loaded vehicles.
- ▷ Pressure in hot tyres must be 0.3 bar higher than in cold tyres. Recheck the pressure when the tyres are cold.
- ▷ Tyre pressures in bar.
- ▷ The tyre pressure tolerance is +/- 0.05 bar.

Types	Tyre size	Front air pressure in bar	Rear air pressure in bar
All types	215/70 R 15 C (109/107) Q	4.1	4.5
All types with motorhome tyres	215/70 R 15 CP (109/107) Q	5.0	5.5
All types with winter tyres (M+S)	215/70 R 15 C (109/107) Q or 215/70 R 15 CP (109/107) Q	4.3	4.75
All types	225/70 R 15 C (109/107) Q	4.1	4.5
All types with motorhome tyres	225/70 R 15 CP (109/107) Q	5.0	5.5
All types with winter tyres (M+S)	225/70 R 15 C (109/107) Q or 225/70 R 15 CP (109/107) Q	4.3	4.75
All types	225/75 R 16 C (116/114) Q	4.5	5.0
All types with motorhome tyres	225/75 R 16 CP (116/114) Q	5.5	5.5
All types with winter tyres (M+S)	225/75 R 16 C (116/114) Q or 225/75 R 16 CP (116/114) Q	5.2	5.2
Light Chassis	235/60 R 17 C (117) R Pirelli, type Chrono/Carrier	4.5	4.5
All types	225/75 R 16 C (116/114) Q (tandem axle)	4.5	3.8
All types with motorhome tyres	225/75 R 16 CP (116/114) Q (tandem axle)	5.5	3.8
All types with winter tyres (M+S)	225/75 R 16 C (116/114) Q (tandem axle) or 225/75 R 16 CP (116/114) Q (tandem axle)	5.2	3.8

The vehicles are constantly brought up to the newest technical standards. It is possible that new tyre sizes are not yet included in this table. If this is the case, any authorised dealer or service centre will be happy to provide the newest values.

Chapter overview

This chapter contains instructions about possible faults in your vehicle. The faults are listed with their possible causes and corresponding remedies. The specified faults can be remedied with relative ease and without a great deal of specialised knowledge. In the event that the remedies detailed in this instruction manual should not be successful, an authorised specialist workshop must find and eliminate the cause of the fault.

15.1 Braking system



- ▶ Have defects on the braking system immediately remedied by an authorised specialist workshop.

15.2 Air suspension



- ▶ Have defects on the air suspension immediately remedied by an authorised specialist workshop.

Fault	Cause	Remedy
Vehicle is at an angle	Alternation of load after switching off the air suspension	Switch air suspension on, lower it and reset the driving level
Remote control does not react	Ignition switched off	Switch on ignition
	Fuse 7.5 A is defective	Change fuse 7.5 A
Compressor does not run	Operating voltage too low	Charge vehicle battery
	Ignition switched off	Switch on ignition
Compressor does not switch off	Fuse 40 A is defective	Replace fuse
	Operating voltage too low	Charge the starter battery
Air suspension does not lower	Compressor relay is defective	Remove fuse 40 A
	Deflation	Contact a specialist workshop
Air suspension does not lift	Driving speed is too high	Observe speed limit
	Fuse is defective	Change fuse 7.5 A
Air suspension does not lift	Vehicle too heavily loaded	Reduce load
	Driving speed is too high	Observe speed limit
	Fuse is defective	Change fuse 7.5 A



- ▷ If the system identifies a fault, the indicator lamp will blink. A fault code can then be called up using the stop button.

See the manufacturer's operating manual for the meaning of individual fault codes.

15.3 Electrical system



- ▷ When the living area battery is changed, only use batteries of the same type and the same capacity.



- ▷ See chapter 9 for changing the fuses.

Fault	Cause	Remedy
Road light system does no longer work correctly	Bulb is defective	Replace bulb. Note volts and watts specifications
Interior lighting does no longer work correctly	Bulb is defective	Replace bulb. Note volts and watts specifications
	Plug connector or cable defective	Contact customer service
	Fuse on the transformer/rectifier is defective	Replace fuse on the transformer/rectifier
One or several light circuits cannot be switched on	One of the voltage inputs is not supplied	Check supply from transformer/from the 12 V supply: <ul style="list-style-type: none"> ● If a fuse is defective: Change the fuse ● If the supply device is switched off: Switch the supply device on ● If the supply device is defective: Contact customer service
	Defective cabling	Check connection cable and plugs and replace if necessary
	Defective light control	Contact customer service
No light circuit can be switched on	Battery is discharged	Charge the battery
	Defective light control	Contact customer service
Light scenes cannot be saved	Defective light control	Contact customer service
The electrically operated entrance step cannot be moved in or out	Fuse on the transformer/rectifier is defective	Replace fuse on the transformer/rectifier

Fault	Cause	Remedy
"-40" or "60" flashes when the temperature display is selected	External temperature sensor or connecting cable to the external temperature sensor is defective	Contact customer service
230 V indicator lamp does not light up, although 230 V mains power supply is connected	The mains connection is de-energised	Check mains connection (e.g. campsite)
No 230 V power supply despite connection	230 V automatic circuit breaker has triggered	Switch on the 230 V automatic circuit breaker
	The mains connection is de-energised	Check the mains connection
Starter or living area battery is not charged when operated in 230 V mode	Jumbo flat fuse (50 A) on the starter or living area battery is defective	Replace jumbo flat fuse (50 A) on the starter or living area battery
	Charger module in the transformer/rectifier is defective	Contact customer service
Living area battery is not charged during vehicle operation	Fuse on terminal D+ of the alternator is defective	Replace fuse
	Disconnecter relay in the transformer/rectifier is defective	Contact customer service
Living area battery overloaded ("hot")	Battery selection switch set wrongly	Move position of battery selection switch
	Defective load sensor or relay	Contact customer service
12 V power supply does not work	12 V power supply switched off	Switch 12 V power supply on
	Battery cut-off switch on the transformer/rectifier switched off or battery separation activated	Switch on battery cut-off switch or deactivate battery separation via the panel
	Living area battery is discharged	Charge the living area battery
	Jumbo flat fuse (50 A) on the living area battery is defective	Replace jumbo flat fuse (50 A) on the living area battery
	Disconnecter relay in the transformer/rectifier is defective	Contact customer service

Fault	Cause	Remedy
12 V power supply does not work in 230 V operation	12 V power supply switched off	Switch 12 V power supply on
	Battery cut-off switch on the transformer/rectifier switched off or battery separation activated	Switch on battery cut-off switch or deactivate battery separation via the panel
	Charger module in the transformer/rectifier is defective	Contact customer service
	230 V automatic circuit breaker has triggered	Contact customer service
	Jumbo flat fuse (50 A) on the living area battery is defective	Replace jumbo flat fuse (50 A) on the living area battery
Starter battery is discharged in 12 V operation	Disconnecter relay in the transformer/rectifier is defective	Contact customer service
	Battery cut-off switch on the transformer/rectifier switched off or battery separation activated	Switch on battery cut-off switch or deactivate battery separation via the panel
No voltage is supplied by the living area battery	Living area battery is discharged	Charge living area battery immediately  ▷ Total discharge damages the battery. Before the vehicle is laid up for a long period, fully charge the living area battery and then activate the battery separation/lay-up Discharging is caused by inactive appliances e.g. frost protection valve of the hot-water heater (see chapter 9)
The 12 V indicator lamp does not light up or there is no display on the panel	12 V power supply switched off	Switch 12 V power supply on
	Battery cut-off switch on the transformer/rectifier switched off or battery separation activated	Switch on battery cut-off switch or deactivate battery separation via the panel
	Starter or living area battery is not charged	Charge the starter or living area battery
	Disconnecter relay in the transformer/rectifier is defective	Contact customer service
	Flat fuse (2 A) in the living area battery is defective	Replace flat fuse (2 A) in the living area battery

15.4 Gas system



- ▶ In case of a defect of the gas system (gas odour, high gas consumption) there is danger of explosion! Close regulator tap on the gas bottle immediately. Open doors and windows and ventilate well.
- ▶ If the gas system is defective: Do not smoke; do not ignite any open flames, and do not operate electric switches (light switches etc.). Check the tightness of gas-conducting parts and lines with leakage search spray. Do not check with an open flame.
- ▶ Have the defective gas system repaired by an authorised specialist workshop.

Fault	Cause	Remedy
No gas	Gas bottle is empty	Change gas bottle
	Gas isolator tap closed	Open the gas isolator tap
	Regulator tap on the gas bottle is closed	Open regulator tap on the gas bottle
	External temperature is too low (-42 °C for propane gas, 0 °C for butane gas)	Wait for higher external temperatures
	Built-in appliance is defective	Contact customer service

15.5 Heater/boiler

In the event of a defect contact the nearest customer service workshop of the relevant appliance manufacturer. The list of addresses is enclosed with the accompanying appliance documentation. Only authorised qualified personnel may repair the appliance.

15.5.1 Alde heater/boiler



▷ If a fault occurs in the system, the cause is shown on the display.

Fault	Cause	Remedy
Heater does not ignite with gas operation	Lack of gas	Open regulator tap and gas isolator tap Connect a full gas bottle
Heater does not ignite	Battery voltage too low	Charge battery. If the battery voltage rises above 11 V, the heater is switched on automatically
Heater does not ignite at 230 V electrical operation	No 230 V power supply	Switch on the 230 V automatic circuit breaker Connect the 230 V power supply
Heater switches off	Overheating	Allow the heater to cool. To reset the display, interrupt the 12 V power supply to the heater and switch it back on again
Heater running, but no heat at the convectors	Circulating pump does not work	Switch on room thermostat Contact customer service
Heater and circulating pump running, but no heat at the convectors	Air in the heating system	Bleed hot-water heater

15.6 Air conditioning unit
15.6.1 Truma

Fault	Cause	Remedy
Air conditioning unit does not start up	No 230 V power supply	Connect the vehicle to the local power supply
	230 V automatic circuit breaker has triggered	Switch on the 230 V automatic circuit breaker
Remote control is not working	Remote control batteries empty	Change remote control batteries
Air conditioning unit does not respond to remote control commands	Obstacle between remote control and IR receiver	Remove obstacle
Air conditioning unit does not cool	Temperature has been set incorrectly	Adjust the temperature
	Thermostat defective	Contact customer service
	Defrosting process is running (external temperature between 4 °C and 7 °C)	Wait until defrosting process is finished
Air conditioning unit does not warm up	External temperature below 4 °C	Heating mode not possible
	Temperature has been set incorrectly	Adjust the temperature
	Thermostat defective	Contact customer service
	Filter dirty	Change filter
	Air passages are soiled/obstructed	Clean/clear air passages
	Defrosting process is running (external temperature between 4 °C and 7 °C)	Wait until defrosting process is finished
Water is entering the vehicle	Drainage holes for condensation are clogged	Clean air conditioning unit
	Seal is defective	Contact customer service
	Inclined position	Do not drive on gradients or inclines greater than 8 %
No more air circulation	Air filter clogged	Clean air filter
	Fan wheel defective	Contact customer service

15.6.2 Telair

Fault	Cause	Remedy
Air conditioning unit does not start up	No 230 V power supply	Connect 230 V power supply
	230 V automatic circuit breaker has triggered	Switch on the 230 V automatic circuit breaker
	Remote control batteries empty	Change batteries (2 x AAA)
Air conditioning unit does not cool	Room temperature is lower than the preset temperature	Reset temperature
Air conditioning unit does not heat	Room temperature is higher than the preset temperature	Reset temperature
Insufficient ventilation rating	Ventilation flaps closed	Open at least one ventilation flap
	Filter dirty	Clean the filter
Water is entering the vehicle	Drainage holes for condensation are clogged	Clean air conditioning unit

15.7 Cooker

15.7.1 Gas cooker/gas oven

Fault	Cause	Remedy
Ignition fuse does not operate (flame does not burn after the control knobs are released)	Heat-up time is too short	Keep control knob pressed for approx. 15 to 20 seconds after ignition
	Ignition fuse is defective	Contact customer service
Flame extinguishes when being reduced to its minimum setting	Thermocouple sensor is incorrectly set	Correctly reset thermocouple sensor (do not bend). The sensor tip should protrude by 5 mm beyond the burner. The sensor neck should not be more than 3 mm away from the burner ring; if necessary, contact customer service

15.7.2 Extractor hood

Fault	Cause	Remedy
Extractor hood does not work	230 V automatic circuit breaker is switched off	Switch on 230 V automatic circuit breaker
	Fuse (15 A) at the transformer/rectifier is defective	Replace fuse (15 A)
	Extractor hood is defective	Contact customer service

15.7.3 Microwave oven



► Only qualified personnel may repair the microwave oven. Improper repairs can cause major risks to the user.

Fault	Cause	Remedy
Microwave oven does not cut in	Fuse is defective	Replace fuse
	Door of the microwave oven is not properly closed	Remove foreign bodies stuck in the door of the microwave oven and close door properly

15.8 Refrigerator

15.8.1 General

In the event of a defect contact the nearest customer service workshop of the relevant appliance manufacturer. The list of addresses is enclosed with the accompanying appliance documentation. Only authorised qualified personnel may repair the appliance.



▷ Further information can be obtained in the manufacturer's instruction manual.

Fault	Cause	Remedy
Refrigerator does not refrigerate sufficiently	Insufficient ventilation of unit	Check if ventilation grills are covered; remove covers if necessary
		Remove ventilation grills and clean the space behind them (of leaves etc.)
	Thermostat adjusted too low	Adjust higher value on thermostat
	Post evaporator heavily iced-over	Check if refrigerator door closes correctly
	Too many warm foods stored in a short period of time	Let warm foods cool down before storage
	Appliance has not been running long enough	Check again after 4 or 5 hours if the refrigerator cools
	Ambient temperature is too high	Remove the ventilation grills periodically
Refrigerator does not refrigerate in gas operation	Lack of gas	Connect a full gas bottle
		Open regulator tap and gas isolator tap
	Air in the gas pipe	Switch appliance off and start it up again (if necessary, repeat procedure 3 to 4 times)
Refrigerator does not refrigerate in 12 V operation	Fuse is defective	Replace fuse
	Battery is discharged	Check and charge battery
	Ignition switched off	Switch on ignition
	Heating element is defective	Contact customer service

Fault	Cause	Remedy
Refrigerator does not refrigerate in 230 V operation	Fuse is defective	Replace fuse
	No 230 V power supply	Connect 230 V power supply
	Heating element is defective	Contact customer service
Refrigerator changes into gas mode in spite of mains connection	Line voltage too low	Check line voltage (refrigerator will automatically change into 230 V operation in case of correct line voltage)

15.8.2 Dometic MES/AES

In addition to the faults mentioned in section 15.8.1, the following faults can be indicated via light symbols on the Dometic refrigerator.



- ▷ In the event of a fault, the illuminated Fault button will flash. Also, either one of the illuminated buttons for operating mode or the cooling level indicator will flash. In addition, a warning signal will sound.

Fault	Cause	Remedy
LED "⚡" flashes	No 230 V power supply	Connect 230 V power supply
	230 V automatic circuit breaker has triggered	Switch on 230 V automatic circuit breaker
	230 V operating voltage too low	Have the 230 V power supply checked by an authorised specialist workshop
LED "⚡" flashes	Fuse on the transformer/rectifier is defective	Replace fuse on the transformer/rectifier
	Disconnecter relay in the transformer/rectifier is defective	Contact customer service
	12 V operating voltage too low	Have the 12 V power supply checked by an authorised specialist workshop
	No D+ signal	Contact customer service
LED "🔥" flashes ¹⁾	Lack of gas	Open regulator tap and gas isolator tap
		Connect a full gas bottle
	Cobwebs or burnt residue in the burning chamber	Remove the ventilation grill on the outside of the vehicle and clean the burning chamber
LEDs for display of the cooling level are flashing	Temperature sensor defective	Contact customer service

Fault	Cause	Remedy
LED "⚡" and LEDs for display of the cooling level are flashing	230 V heating element defective	Contact customer service
LED "⊕" and LEDs for display of the cooling level are flashing	12 V heating element defective	Contact customer service
LED "🔥" and LEDs for display of the cooling level are flashing	Faulty burner or power unit	Contact customer service

1) After fixing the issue, press the illuminated button for "Fault"/"Reset".

15.9 Water supply

Fault	Cause	Remedy
Leakage water inside the vehicle	A leak has occurred	Identify leak, re-connect water pipes
No water	Water tank is empty	Replenish drinking water
	Drain cock not closed	Close drain cock
	12 V power supply is switched off	Switch 12 V power supply on
	Fuse of the water pump is defective	Replace fuse on the transformer/rectifier
	Water pump defective	Exchange water pump (have it exchanged)
	Water pipe snapped off	Straighten water pipe or replace
	Transformer/rectifier defective	Contact customer service
	Water pump switched off on panel	Switch water pump on
Toilet has no flush water	Water tank is empty	Replenish drinking water
	Fuse for toilet is defective	Replace fuse
Display for water and waste water indicates a wrong value	Measuring probe in the waste water or water tank is soiled	Clean water/waste water tank
	Measuring probe is defective	Replace measuring probe
Waste water tank cannot be emptied	Drain cock is clogged	Open the cleaning cap on the waste water tank and drain the waste water. Rinse the waste water tank well
Drain on the single lever mixer tap is clogged	Perlator calcified	De-calcify or replace perlator
Water jets on the shower nozzle clogged	Water jets calcified	De-calcify shower nozzle or rub off nozzle burling

Fault	Cause	Remedy
Water drains from the shower tray slowly or does not drain at all	The vehicle is not in a horizontal position	Position the vehicle horizontally
Milkiess of the water	Tank filled with dirty water	Clean water tank mechanically and chemically; then disinfect and rinse copiously with drinking water
	Residues in the water tank or water system	Clean water system mechanically and chemically; then disinfect and rinse copiously with drinking water
Any change in the taste or odour of the water	Tank filled with dirty water	Clean water system mechanically and chemically; then disinfect and rinse copiously with drinking water
	Fuel filled into the water tank by mistake	Clean water system mechanically and chemically; then disinfect and rinse copiously with drinking water. If not successful: Contact a specialist workshop
	Microbiological deposits in the water system	Clean water system mechanically and chemically; then disinfect and rinse copiously with drinking water
Deposits in the water tank and/or water-carrying components	Water excessively long in the water tank and in water-carrying components	Clean water system mechanically and chemically; then disinfect and rinse copiously with drinking water

15.10 Body

Fault	Cause	Remedy
Flap hinges/door hinges are difficult to operate	Flap/door hinges are not sufficiently lubricated	Lubricate flap hinges/door hinges with acid-free and resin-free grease
Hinges/joints in the bathroom unit/toilet compartment are difficult to operate/make a grating noise	Hinges/joints are not sufficiently lubricated	Lubricate hinges/joints with solvent-free and acid-free grease  ▷ Spray cans often contain solvents
Storage compartment hinges are difficult to operate/make a grating noise	Storage compartment hinges are not sufficiently lubricated	Lubricate storage compartment hinges with acid-free and resin-free grease
Wind-up skylight is difficult to operate	Threaded spindle not lubricated	Lubricate threaded spindle
	Threaded spindle defective	Have threaded spindle replaced



- ▷ The authorised dealers and service centres are available for any spare parts requirement.

16.1 Weight details for special equipment



- ▶ The use of accessories, parts and fittings not supplied by us may cause damage to the vehicle and jeopardize road safety. Even if an expert's report, a general type approval or a design certification exists, there is no guarantee for the proper quality of the product.
- ▶ Every alteration of the original condition of the vehicle can alter road behaviour and jeopardize road safety.
- ▶ No liability can be assumed for damage caused by products which have not been released by us. This also applies to impermissible alterations to the vehicle.

Weight details for factory-provided special equipment are listed in the table below. If these objects are either carried in or on the vehicle and are not part of the standard equipment, they must be taken into consideration when calculating the payload.

All weight details are approximate.

Observe the max. permissible gross weight.

Item designation	Surplus weight (kg)
Alcove window, left	5
Caravan coupling	50
External shower	1
Automatic transmission	17
Omnivent skylight	4
Scatter cushions (4 pcs.)	2
Spare wheel 16" with support	28
External gas connection	1
Bike rack for 2 bicycles	9
Bike rack for 2 bicycles, lowerable	18
Bike rack for 3 bicycles	11
Bike rack for 3 bicycles, lowerable	19
Roman shade, driver's cabin	15
Floor warming unit	8
Gas bottle (11 kg) made of aluminium	12
Gas alarm system	1
Flat screen holder (additional)	4
Air conditioning unit (Truma)	33
Driver's cabin air conditioning unit	19
Air conditioning unit (Telair)	26
Preparation for air conditioning unit	20
Fuel tank 120 l	28
Alloy wheel rims (tandem axle)	-20
Air Premium II air suspension	79

Item designation	Surplus weight (kg)
Air Premium X4 air suspension	113
Awning 600 cm	72
Microwave oven	14
Minisafe	12
Multimedia system	5
Satellite unit + flat screen	14–25
Solar installation 1 x 100 W	12
Solar installation 2 x 100 W	20
Telescopic ladder	8
Carpet in living area and driver's cabin	14
Water tank, additional 130 l	14
Winter insulation mat, outside	7
Conversion door central locking system	2

Engine variants

The vehicle mass in a ready-to-drive state relates to the base vehicle. If a more powerful engine is fitted, the mass increases in a ready-to-drive state.

Engine variant	Surplus weight (kg)
2.3 Mjet Maxi	40

Equipment packages

The equipment packages depend on the model. To calculate the additional weight, add the additional weights of the individual special equipment per package.

17.1 View of ground plans

Explanations

- (1) 230 V fuse
- (2) Transformer/rectifier with 12 V fuses
- (3) Living area battery with main fuse
- (4) Water pump mounted in the tank area
- (5) Drain cock, waste water tank
- (8) Water drain cock – yellow
- (9) Water tank
- (11) Alde hot-water heater
- (12) Compensator reservoir for Alde hot-water heater
- (13) Alde auxiliary heat exchanger
- * Access via service flap

Specifications without guarantee

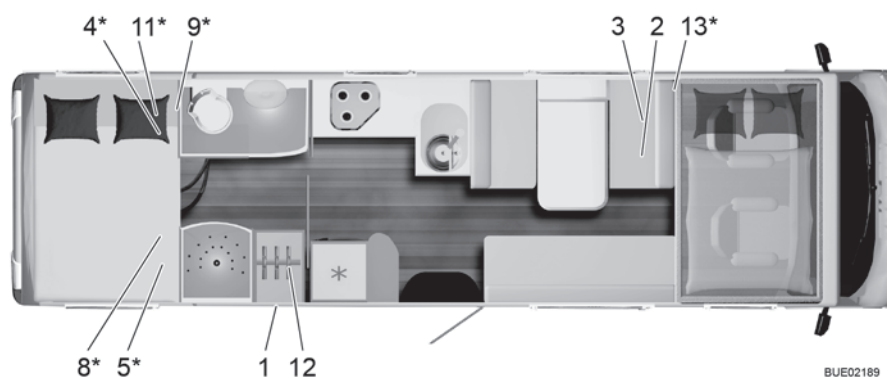

Fig. 202 Ground plan A 747-2 G

17.2 Table of linear measures / sleeping places

Type	Body width, exterior	Total length without ladder	Wheel-base	Overall height without antenna	Sleeping places
A 747-2 G	2300	8860	4656/ 800	3250	7

Chapter overview

This chapter contains helpful tips for the journey.

At the end of the chapter there is a checklist containing the most important equipment for the journey.

18.1 Traffic rules in foreign countries



- ▷ The vehicle driver is required to inform himself as to the traffic rules of the countries in which he plans to travel before beginning the trip. Contact your automobile club or embassy for further information.
- ▷ In some European countries, warning vests must be worn when exiting the vehicle outside of towns in the case of vehicle failures or accidents.
- ▷ Depending on the country, different rules and regulations apply (e.g. different warning signs for rear carriers, obligation to carry breathalyzer kits, spare bulbs, high-visibility vests, size of reserve canister). The driver of the vehicle must familiarise him or herself with these rules before every journey.
- ▷ Up-to-date information can generally be found on the web pages of the national automobile associations.

Information about traffic regulations is especially important as state law applies in case of damage. For your own safety, always observe the following rules when travelling abroad:

- Carry your insurance certificate with you.
- Always register accidents with the police.
- Never sign documents that you have not read and understood completely.

18.2 Help on Europe's roads



- ▷ Before commencing the trip, gather information on national phone numbers for rescue and police. In many countries the central emergency phone number 112 (without area code) applies.
- ▷ As far as possible, draw up a list with the important phone numbers in the travelled countries and keep the table in the vehicle.

Motoring clubs at home or in the travelled country are happy to help.

18.3 Gas supply in European countries



- ▷ In Europe, there are several different connection systems for gas bottles. It is not always possible to fill or exchange your gas bottles in a foreign country. Get information about the connection system in the country you are travelling to before embarking on your journey, e.g. at a motoring club or in the trade press.

General tips

Always observe the following instructions:

- Only go on vacation with completely filled gas bottles.
- Use all of the gas bottles' capacity.
- Take along adapter sets (available in camping supply stores) for filling gas bottles in foreign countries and for connecting the gas pressure regulator to foreign gas bottles.
- During the cold time of the year observe filling with propane gas component (butane does not gas below 0 °C).
- Use blue bottles from the firm Campingaz (distributed world-wide). Only use gas bottles with safety valves.
- When bottles from other countries are used, check the gas bottle compartments to see if the gas bottles fit into them. Gas bottles from other countries do not always display the same size as your own gas bottles.
- The web site www.mylpg.eu provides an overview of gas suppliers in Europe.

18.4 Toll regulations in European countries

Many European countries have introduced a mandatory toll system. The toll regulations and how they are collected vary greatly from country to country. Nevertheless, ignorance is no excuse. Penalties can be quite severe.

As is the case with traffic regulations, the vehicle driver is required to be familiar with the toll formalities before starting out on a trip. For example, in Austria the vignette does not meet the toll requirements for vehicles that weigh more than 3.5 t. There, a so-called "Go-Box" must be obtained and charged.

Contact your automobile club or the Internet for further information.



- ▷ Windscreens with solar filters can affect the functioning of automatic toll collection systems (e.g. Go-Box). This must be taken into account when acquiring the appropriate device (e.g. Split-Go-Box).

18.5 Tips on staying overnight safely during travel

Prudent behaviour is the most important protective measure for insuring a safe night in the motorhome.

The risk of thievery is reduced to a minimum when the following basic rules are observed:

- Before commencing the journey, close and lock all windows, doors and skylights.
- During high season do not spend the night at highway rest stops or parking areas located along typical vacation routes.
- Several vehicles on one site at the same time do not necessarily decrease the chances of thievery occurring. Consult your own feelings about the parking site.
- Even if it is just for one night, go to a camping site.
- When parking on open space keep emergency routes clear. The way to the driver's seat should be clear. The ignition key should always be within reach.
- Only take with you those valuables which are absolutely necessary for the journey. If possible, store valuables in a small safe and not in the immediate vicinity of windows or doors.
- Always lock up the vehicle.

18.6 Tips for winter campers

The following tips will help make your winter camping experience as agreeable as possible.

- Reserve your parking place in good time. Good winter camping sites are often booked up early.
- Do not start your trip without winter tyres.
- Bring snow chains.
- Choose your parking place with care. Observe the ground beneath you. Snow and ice may melt.
- When the vehicle has been positioned, release the handbrake to prevent freezing.
- No snow walls should be allowed to cover the built-in forced ventilation.
- Keep the built-in forced ventilation free from snow and ice.
- Make sure the air circulation is good. Good air circulation prevents moisture from collecting and makes it easier to heat the living area.
- Cover the single-paned driver's cabin window with insulation mats to avoid thermal bridges.
- Follow the instructions in the section "Gas supply in European countries".
- Use a two-bottle system with automatic controller for the gas system, so that the supply does not run out during the night.
- Only operate the gas system using propane gas.
- Do not use the space behind the heater as a storage space.
- Never operate catalytic ovens or infra-red gas radiators in the interior of the vehicle, since they consume oxygen for burning.
- Lay the 230 V power cable in such a way that the cable cannot be frozen or be damaged (e.g. during snow removal).
- When it is snowing heavily, clear the roof of the vehicle of snow regularly. A few centimetres of powdery snow serves as insulation, but wet snow quickly becomes a heavy burden.
- Before embarking on the return journey, remove all the snow from the roof to avoid impeding vehicles behind you with a "snow flag".

18.7 Travel checklists

The following checklists will help that nothing important is left at home although not everything on the checklists might be necessary.



- ▷ Do not leave checking of documents (e.g. vehicle papers and information) as well as checking the condition of the vehicle until just before commencing the trip. Planning and checking documents well in advance will save unnecessary trouble.

Kitchen area

✓	Object	✓	Object	✓	Object
	Wiping cloth		Cleansing agent (detergent)		Salad servers
	Silverware		Dishcloths		Chopping board
	Turnspit		Glasses		Brush to wash the dishes
	Can opener		Set of knives and forks for grilling		Cloth to wash the dishes
	Ice cube tray		Corkscrew		Matches
	Lighter		Kitchen paper		Thermos jug
	Bottle opener		Garbage bags		Pots
	Air-tight storage boxes		Frying pans		
	Crockery		Stirring spoons		

Bathroom/sanitary items

	Towels		Sanitary items		Toilet paper
	Hygiene products		Toilet brush		Toothbrush glass

Living area

	Dustbin		Deck of cards		Rucksack
	Road atlas		Broom		Sleeping bags
	Bath towels		Dust pan		Pencils and paper
	Bath shoes		Candles		Shoes
	Batteries		Coat-hangers		Shoe polish
	Bed linen		Clothes brush		Sports equipment
	Laundry bag		Pillow		Vacuum cleaner
	Books		Map		Flash light
	Camping guide/ parking space directory		Medicine		Pocket knife
	Binoculars		Mobile phone		Table cloth
	Fire extinguisher		Sewing kit		Drinking bottle
	Gas bottle		Rain clothes		Clothes pins
	Insect lamp		First aid kit		Clothesline
	Insect repellent		Travel guide		

Vehicle/tools

✓	Object	✓	Object	✓	Object
	Waste water container		Gas tube		Snow chains (winter)
	Adapter socket		Fabric tape		Screwdriver
	CEE adapter		Watering can for drinking water		Current-measuring instrument
	Wire		Cable reel		Step
	Spare wheel		V-belt		Wheel chocks
	Spare lamps		Glue		First-aid kit
	Spare fuses		Universal pliers		Vehicle jack
	Replacement water pump		Compressor		Hazard warning triangle
	Hammer		Loops		Warning sign
	Flat wrench		Tube adapter		Warning vest(s)
	Gas filling adapter		Hose clips		Flashing hazard warning light

Outside

	Stay rope		Camping table		Lock
	Bellows		Luggage racks		String
	Camping chairs		Grill		Tent pegs/tightening ropes

Documents

	List of addresses		Registration book		Passport
	Registration confirmation(s)		Driving licence		Writ of protection
	Allergy certificate		Vaccination certificate		Insurance documents
	Instruction manuals		Credit card		Vignette/toll card
	Instruction leaflets for medicines		Identity card		Visa



Pos.	Component	Activity	Interval
1	Auxiliary support	Lubrication	Annually
2	Tyres and wheel rims	Air pressure check (see section 14.7). Visual check for damage	Annually
3	Outside lighting	Function check	Annually
4	Joints, hinges	Lubrication	Annually
5	Refrigerator, heater, boiler, cooker, lighting, flap and door closures, toilet, seat belts	Function check	Annually
6	Windows, skylights	Function check, water ingress test	Annually
7	Cushions, curtains, blinds	Visual check	Annually
8	Sealing strips, edges, rubber	Check for damage	Annually
9	Water supply	Water ingress test	Annually
10	Hot-air system	Function check, clean fan wheel as necessary	Annually
11	Floor skirt attachment	Visual check	Annually
12	Electrical system	Function check	Annually
13	Gas system	Official gas inspection	Every two years
14	Connections between the chassis and body	Check	Every two years

Delivery _____	Pos. 1-12
Stamp of the Bürstner dealer	
Date	Signature

1st year _____	Pos. 1-12
Stamp of the Bürstner dealer	
Date	Signature

2nd year _____	Pos. 1-14
Stamp of the Bürstner dealer	
Date	Signature

3rd year _____	Pos. 1-12
Stamp of the Bürstner dealer	
Date	Signature

4th year _____	Pos. 1-14
Stamp of the Bürstner dealer	
Date	Signature

5th year _____	Pos. 1-12
Stamp of the Bürstner dealer	
Date	Signature

6th year _____	Pos. 1-14
Stamp of the Bürstner dealer	
Date	Signature

7th year _____	Pos. 1-12
Stamp of the Bürstner dealer	
Date	Signature

8th year _____	Pos. 1-14
Stamp of the Bürstner dealer	
Date	Signature



12 V fuses	127	Lighting	150
For Thetford toilet	129	Operating modes	148
Heater for waste water pipes	129	Remote control	148
On the living area battery	128	Soft-start	150
On the relay box AD01	128	Switching off	148
On the starter battery	127	Switching on	148
On the transformer/rectifier	128	Timer	150
12 V main switch	120	Troubleshooting	213
12 V power supply	111	Air suspension	43, 44
Switching on	120	Care	177
Troubleshooting	210	Front and rear axle	46
230 V connection	56, 125, 126	Functions	44, 47
External flap	69	Remote control	44, 46
Troubleshooting	209	Safety instructions	43
230 V fuse	130	Troubleshooting	207
Position	223	AL-KO rear axle	196
230 V fuse box	130	Antenna alignment	60
230 V indicator lamp	119	Automatic	59
230 V power supply	125	Appliances	137
3-way valve	142	Manuals	16
		Warranty cards	1
		Automatic power selection (AES)	157
		Auxiliary water tank	164
		Awning	62
		B	
A		Basic equipment	24
Access ladder, overcab bed	95	Battery alarm	122
Accessories, fitting	16	Battery monitor	117
Actual weight	24	Battery see starter battery or living	
Additional equipment	25	area battery	112, 113
Additional seat	94	Battery selector switch	117
Add-on parts see special equipment	16	Battery separation	117
Add-on parts, securing	38	Battery voltage, displaying	120
Adjustable head section, fixed bed	96	Bed extension, securing	38
Adjustment mechanism, divan	93	Beds	94
Air conditioning unit (Telair)		Before the journey	23
Care	181	Bike rack	
Filter, cleaning	181	Bicycles, loading	31
Operating modes	151	Load	30, 32
Switching off	152	Lowerable	31
Switching on	151	Not lowerable	31
Troubleshooting	214	Travelling with a loaded bike rack	30, 32
Ventilation grill, cleaning	181	Blind, cleaning	178
Air conditioning unit (Truma)	147	Blind, window	
Air circulation	149	Closing	81
Air distribution	149	Opening	81
Automatic mode	148	Block diagram, panel (LT 511)	133
Care	181		
Cooling	149		
Filter, cleaning	181		
Heater	149		

Index

- Boiler (Alde)
Emptying144
Position223
Troubleshooting212
Water, filling with144
- Brakes 43
Check43, 207
- Braking system, troubleshooting207
- Breakdown services in Europe225
- Bulbs, changing 191, 193
Exterior lighting191
Halogen ceiling lamp194
Interior lighting193
Rear lights192
Recessed halogen light194
Side lights192
Surface mounted light195
Types of external bulbs193
Wardrobe light195
- Butane gas19, 100
- C**
- Cable reel126
- Camping gas bottles, use20, 101
- Camping in winter227
- Cap, drinking water filler neck69
- Capacity of the battery110
- Caravan couplings35
With detachable ball neck34
- Care175
Air conditioning unit (Telair)181
Air conditioning unit (Truma)181
Air suspension177
Blind178
Carpet177
Curtains177
Entrance step176
External care175
Extractor hood181
Furniture surfaces177
Gas cooker178
High-pressure cleaner, washing with175
Hot-water heater188
In the winter182
Insect screen178
Interior care177
Lamps177
Leather covers177
Net curtains177
PVC-floor covering178
Roman shade178
Scratch-resistant surface178
Seat belt178
Sink178
Synthetic parts, interior177
Temporary lay-up183
Upholstery177
Washing176
Waste water tank180
Water pipes179
Water system179
Water tank179
Windows176
Winter lay-up184
- Carpet, cleaning177
- Ceiling lamp194
- Central locking system63
Remote control63
- Central seating group, sleeping conversion96
- Chassis number197
- Checklist
Before the journey39
For the journey228
Initial start-up after temporary lay-up185
Road safety39
Temporary lay-up183
Winter lay-up184
- Checks see checklist39, 183
- Child restraint systems50
- Children's beds94
- Circuit diagram
Exterior135
Interior132
- Circulating pump, setting the rotational speed142
- Cleaning see care175
- Closed circuit current109
- Condensation77, 78
Condensation on the double acrylic glass pane78
Condensation on the screwed connections in the floor77
- Connecting cable see 230 V power supply126
- Conventional load25
- Conversion door64, 65

Roman shade, closing 65
 Roman shade, opening 65
 Unlocking 63
 Conversion door, inside
 Locking 65
 Opening 65
 Conversion door, outside
 Locking 64
 Opening 64
 Conversion to bed foundation
 (suspension table) 93
 Cooker 152
 Troubleshooting 214
 Cooker see gas cooker or gas oven 152
 Curtains, cleaning 177

D

Danger of suffocation16, 77
 Dimensions see table of linear measures 223
 Direction indicator 191
 Displays
 Battery voltage 120
 Temperature 123
 Waste water tank level 122
 Water tank level 122
 Disposal
 Household waste8
 Sewage8
 Waste water8
 Divan adjustment mechanism 93
 Door lock 64
 Doors
 Conversion door 64
 Lock 64
 Locking 63
 Maintenance work 188
 Troubleshooting 220
 Unlocking 63
 Double floor, load 29
 Drain cock, waste water tank 169
 Position 223
 Drain cocks, position145, 223
 Drinking water filler neck 165
 Closing 165
 Opening 165
 Driver's cabin partition 72
 Closing 72
 Opening 72

Driver's seat51
 Driving speed42
 Driving the motorhome41
 During the journey41

E

Electrical system 109
 230 V connection, troubleshooting 209
 Entrance step, troubleshooting 208
 Explanation of terms 109
 Lighting, troubleshooting 208
 Safety instructions20
 Troubleshooting 208
 Emergency release68
 Emissions test 187
 Entrance step55
 Care 176
 Electrically operated36
 Extending36
 Indicator lamp36, 37
 Retracting37
 Troubleshooting 208
 Environmental tips8
 Exterior lighting
 Bulbs, changing 191
 Checking39
 Troubleshooting 208
 External care 175
 External connection see 230 V connection56
 External flaps66
 Flap lock66, 67, 68
 External gas connection 103
 External shower97
 Connection97
 Emptying97
 External socket 131
 Extractor hood 155
 Active carbon filter, replacing 188
 Care 181
 Filter, cleaning 181
 Troubleshooting 215

F

Fault current protection switch 125
 Check 130
 Filling the tank54



Index

- Fire
Behaviour in the event of 15
Extinguishing 15
Fire prevention 15
Fire risks, avoidance 15
FI-switch see fault current protection switch .. 130
Fixed bed 96
Head section, lowering 96
Head section, raising 96
Flap lock
Closing 67, 68, 69
Opening 67, 68, 69
Service flap 68
Square 67
With recessed handle 67
Flat screen
Positioning 77
Storing 77
Flat screen with holder 77
Floor compartment 71
Closing 71
Opening 71
Floor warming unit, electrical
Overload protection 147
Switching off 147
Switching on 147
Folding mechanism, overcab bed 95
Forced ventilation 16, 77
Front passenger's seat 51
Fuel filler neck 54
Furniture flaps 70
Closing 70, 71
Opening 70, 71
Furniture flaps, troubleshooting 220
Furniture surfaces, cleaning 177
Fuse box 130
Fuses
12 V fuses 127
230 V fuse 125, 130
For the Thetford toilet 129
For waste water heating 129
On the living area battery 128
On the relay box AD01 128
On the starter battery 127
On the transformer/rectifier EBL 223 128
Fuses see 12 V fuses and 230 V fuse 127
- G**
Garage flap 68
Gas bottle compartment 19, 100
Gas bottles
Changing 107
Safety instructions 20, 101
Gas connection, external 103
Gas cooker
Cleaning 178
Switching off 153
Switching on 153
Troubleshooting 214
Gas grill 152
Switching off 154
Switching on 154
Gas isolator taps 102
Symbols 102, 137
Gas odour 19, 99, 211
Gas oven 152
Switching off 154
Switching on 154
Troubleshooting 214
Gas pressure regulator, screw connections 101
Gas supply in European countries 226
Gas system 99
Defect 19, 99, 211
General instructions 18
No gas 211
Safety instructions 18, 99
Switching automatics 104
Troubleshooting 211
General instructions 8
Ground plans 223
- H**
Halogen ceiling lamp 194
Handbrake 55
Applying 16
Handling of tyres 201
Headrests 52
Heat exchanger (Alde)
Position 143
Turning off 143
Turning on 143
Heater 138
Heat circulation, regulating 142
Initial start-up 138
Troubleshooting 212

Heater for the waste water tank and waste water pipes	170	Information stickers	197
Heater for waste water pipes, fuses	129	Inner door, troubleshooting	220
Heki skylight	85	Inner doors	70
Closing	85	Insect screen door	
Insect screen	86	Closing	66
Opening	85	Opening	66
Roman shade	86	Insect screen Omni-Vent skylight	
Ventilation position	86	Closing	88
Help on Europe's roads	225	Opening	88
High rate of gas consumption	19, 99, 211	Insect screen, cleaning	178
High-pressure cleaner, washing with	175	Insect screen, Heki skylight	
Hinged window		Closing	86
Blind	81	Opening	86
Closing	80	Insect screen, Skyroof skylight	
Continuous ventilation	80	Closing	91
Insect screen	81, 82	Opening	91
Opening	79	Insect screen, windows	
Roman shade	82	Closing	81, 82
Hot-water heater		Opening	81, 82
230 V electrical operation, selecting	141	Insect screen, wind-up skylight	
3-way valve	142	Closing	87
Adjustment menu	140	Opening	87
Auxiliary circulating pump	144	Inspection plan	231
Care	188	Inspection time limits	187
Fluid level, checking	189	Inspection work	187
Gas and 230 V electrical operation, selecting	141	Inspections	187
Gas operation, selecting	141	Inspections, official	187
Heat exchanger	143	Inspection time limits	187
Heater, switching off	141	Interior care	177
Heater, switching on	141	Interior lighting	
Heating fluid, topping up	189	Bulbs, changing	193
Heating system, bleeding	190	Troubleshooting	208
Maintenance work	188		
Operating modes	141	K	
Operating unit	138	Keys	23
Position	223		
Rotational speed, circulating pump	142	L	
Safety instructions	138	Ladder, overcab bed	95
Start screen	139	Lamps	193
Tool menus	140	Cleaning	177
Troubleshooting	212	Lay-up	
		Temporary	183
I		Winter lay-up	184
Indicator lamp, 230 V power supply	119	Leakage water inside the vehicle	218
Indicator lamp, entrance step	37	Leather covers, cleaning	177
Indicator lamp, toilet	173	Light control	75

Index

Light switch	75
Living area	74
Toilet compartment	73
Lighting	
Front	191
Lamps, cleaning	177
Rear	192
Side	192
Troubleshooting	208
Lights see bulbs, changing	193
Living area battery	113
Battery alarm	122
Fuses	128
Instructions	113
Maintenance work	188
Position	223
Troubleshooting	209, 210
Voltage, displaying	120
Load	27
Bike rack	30
Bike/e-bike bike rack	32
Double floor	29
Rear garage	29
Rear storage space	29
Load rack	33
Load see also payload	27
Lock	
Conversion door	64
External flap	67, 68
Furniture flap	70
Low beam	191

M

Main beam	191
Maintenance	187
Maintenance work	188
Air conditioning unit (Telair)	181
Air conditioning unit (Truma)	181
AL-KO rear axle	196
Doors	188
Extractor hood	188
Hot-water heater	188
Living area battery	188
Marker light	192
Mass in ready-to-drive condition	24, 26
Maximum permissible gross weight	24, 26

Mechanical steady legs	
Extending	56
Length, adjustment	56
Retracting	56
Microwave oven	
Switching off	155
Switching on	155
Troubleshooting	215
Monitor, reversing camera	42

N

Net curtains, cleaning	177
Nose weight	34

O

Official inspections	187
Off-load voltage	109
Omni-Vent skylight	88
Aerating	89
Boost function	89
Closing	88
Fan, switching off	88, 89
Opening	88
Venting	88
Operating modes, air conditioning unit (Telair)	151
Operating modes, air conditioning unit (Truma)	148
Operating modes, boiler (Alde)	141
Operating modes, hot-water heater	141
Operating modes, refrigerator (Dometic)	157
Overcab bed	94
Access ladder	95
Folding downwards	95
Folding mechanism	95
Folding upwards	95
Safety net	95
Overloading	27

P

Panel (light control)	75
Panel (LT 511)	118
12 V main switch	120
230 V indicator lamp	119
Alarms	122
Battery displays	120
Block diagram	133

Tank display	122	Roman shade, driver's window	
Temperature display	123	Closing	84
Water pump switch	123	Opening	84
Parking light	191	Roman shade, front passenger's window	
Payload	23, 24	Closing	84
Calculation	26	Opening	84
Composition	25	Roman shade, Heki skylight	
Example calculation	25, 26	Closing	86
Payload see also load	23	Opening	86
Permissible gross weight		Roman shade, Skyroof skylight	
see maximum permissible gross weight	23	Closing	91
Personal equipment	25	Opening	91
Pilot seat see driver's seat		Roman shade, window of conversion door	
and front passenger's seat	51	Closing	65
Pleated Roman shades	53	Opening	65
Propane gas	19, 100	Roman shade, windows	
PVC-floor covering, cleaning	178	Closing	82
		Opening	82
		Roman shade, windscreen	53
		Closing	83
		Opening	84
		Roman shade, wind-up skylight	
		Closing	87
		Opening	87
		Roman shades, Remis	54
		S	
		Safety cut-out	130
		Safety instructions	15
		Cooker	152
		Electrical system	20
		Fire prevention	15
		Gas bottles	101
		Gas system	18, 99
		Heater	138
		Road safety	16
		Towing	18
		Water system	21
		Wheels, changing	201
		Safety knob, hinged window	79, 89
		Safety net, overcab bed	95
		Safety switch (FI)	130
		Sanitary fittings	163
		SAT socket	131
		Satellite unit	57, 60
		With automatic antenna alignment	59, 60
		With manual satellite selection	58
		Scratch-resistant surface, care	178

Index

Seat belts	49	Spotlight	74, 194
Cleaning	178	Removing	75
Fastening correctly	49	Shifting	75
Seat heater	52	Turning	74
Seating arrangement	53	Starter battery	112
Seating groups, sleeping conversion	96	Battery alarm	122
Selector switch for radio	111	Charging	112
Serial number	197	Discharging	112
Sewage tank		Fuses	127
Emptying	174	Instructions	112
Removing	174	Troubleshooting	209
Retaining clip	174	Voltage, displaying	120
Shade, Omni-Vent skylight		Start-up	
Closing	88	After temporary lay-up	185
Opening	88	After winter lay-up	185
Shower	171	Staying overnight, during travel	227
Shower connection point, external shower	97	Steady legs	56
Shower partition, securing	38	Extending	56
Side marker light	192	Length, adjustment	56
Sink, cleaning	178	Retracting	56
Skylights	84	Supports see steady legs	56
Troubleshooting	220	Surface mounted light	195
Skyroof skylight	89	Suspension table	
Closing	90	Conversion to bed foundation	93
Continuous ventilation	90	Extending	92
Insect screen	91	Reducing size	92
Opening	89	Table leg	91
Roman shade	91	Table top	92
Sleeping conversion, central seating group	96	Switching automatics, gas system	104
Snow chains	39	Symbols	
Sockets		For instructions	7
External socket	131	Gas isolator taps	102, 137
SAT socket	131	Synthetic parts in the toilet	
TV socket	131	and living areas, cleaning	177
USB socket	110		
Solar charge regulator	124		
Solar installation	124	T	
Spare parts	196	Table of linear measures	223
Spare wheel	204	Table, cleaning	178
Spare wheel support	204	Tank alarm	122
Special equipment	221	Tank lid see fuel filler neck	54
Description	7	Technical data	223
Marking	7	Television	37
Safety instructions	16	Temperature display	123
Weight details	221	Thetford toilet	
		Flushing	173
		Indicator lamp	173

Tightening torque, wheels	202	Starter battery	209
Tips	225	Toilet	218
Toilet	172	Water supply	218
Fuse	129	TV socket	131
Preparing	172	Tyre change see wheels, changing	201
Troubleshooting	218	Tyre specifications	201
Toilet compartment	171	Tyres	199
Light switch	73	Excessive wear	17, 39, 199, 205
Ventilation	171	General instructions	199
Toilet see also Thetford toilet	172	Handling	201
Toll regulations in European countries	226	Identification	201
Total discharge	109	Load-carrying capacity	202
Towing	18	Tyre pressure	205
General instructions	34	Tyre selection	200
Safety instructions	18		
Traffic rules in foreign countries	225	U	
Transformer/rectifier (EBL 223)	115	Unladen weight	24
Circuit diagram	132	Upholstery, cleaning	177
Functions	116	USB socket	110
Position	117		
Transformer/rectifier, position	223	V	
Travel checklists	228	Vehicle identification plate	197
Travel cots suitable for children	94	Vehicle lighting see exterior lighting	191
Troubleshooting	207	Vehicle, washing	176
12 V power supply	210	Ventilation	77
230 V connection	209	Toilet compartment	171
Air conditioning unit (Telair)	214	Volume of waste water, displaying	122
Air conditioning unit (Truma)	213	Volume of water, displaying	122
Air suspension	207		
Battery	209	W	
Body	220	Wardrobe light	195
Boiler (Alde)	212	Warning stickers	197
Braking system	207	Warranty cards	1
Cooker	214	Washing with a high-pressure cleaner	175
Electrical system	208	Waste gas vent on the right hand side of the vehicle.	138
Entrance step	208	Waste water hose	170
Extractor hood	215	Waste water tank	169
Furniture flaps	220	Care	180
Gas cooker	214	Cleaning	180
Gas oven	214	Cleaning opening	169
Gas system	211	Emptying	170
Heater	212	Filling level, displaying	122
Hot-water heater	212	Heater	170
Inner door	220	Troubleshooting	218
Lighting	208	Water pipes, cleaning	179
Living area battery	209		
Microwave oven	215		
Refrigerator	216		

Index

Water pump	163, 165	Weight details for special equipment	221
Position	223	Wheel chocks	55
Switching on and off	123	Wheel rim size	202
Water supply		Wheel rim type	199
General	163	Wheels	199
Troubleshooting	218	Wheels changing	201
Water system	164	Wheels, changing	
Care	179	Tightening torque	202
Cleaning	179	Window, conversion door	
Disinfecting	180	Roman shade, closing	65
Drinking water filler neck	165	Roman shade, opening	65
Emptying	168	Windows	78
Filling	165	Blind	81
Safety instructions	21	Insect screen	81, 82
Water tank		Roman shade	82, 83
Cleaning	179	Shade	83
Filling level, displaying	122	Windows, cleaning	176
Overflow	167	Wind-up skylight	87
Position	223	Closing	87
Volumes	164	Insect screen	87
Water, draining	167	Opening	87
Water, refilling	166	Roman shade	87
Weatherproof guarantee		Winter care	182
Bürstner Warranty Conditions	11	Winter operation	182
Proof of water ingress tests	13	Work top, cleaning	178
Vehicle data	13		
Water ingress test (certificates)	14		