

Dear Reader ...

We would like to congratulate you on the purchase of your new Bürstner motorhome. You have selected a top-quality vehicle which will afford you many years of enjoyment.

To enable you to always use and operate your motorhome properly and easily, your Bürstner dealer will first provide you detailed instructions for all important functions when you take delivery.

This manual, the instruction manuals from the base vehicle manufacturer as well as the instruction manuals from the appliance manufacturer will always be at hand to answer any questions you may have regarding your motorhome.

Before your first journey

Please familiarise yourself with this manual rather than relying on it strictly for reference.

Fill in the warranty cards for the appliances and special equipment in the individual instructions and send these cards to the respective manufacturers. This ensures your warranty claim for each appliance.

1	Introduction..... 7	5	During the journey.....47
1.1	General 8	5.1	Driving.....47
1.2	Environmental tips..... 8	5.2	Reversing camera (partially special equipment).....48
2	Weatherproof guarantee..... 11	5.3	Driving speed48
2.1	Bürstner Warranty Conditions 11	5.4	Brakes49
2.2	Proof of water ingress tests..... 13	5.5	Air suspension AL-KO (special equipment).....49
2.2.1	Vehicle data..... 13	5.5.1	General instructions.....49
2.2.2	Water ingress test (certificates) 14	5.5.2	Front and rear axle air suspension.....50
3	Safety 15	5.6	Seat belts.....53
3.1	Fire prevention..... 15	5.6.1	General.....53
3.1.1	Avoidance of fire risks 15	5.6.2	Fastening the seat belts correctly.....53
3.1.2	Fire-fighting 15	5.7	Child restraint systems53
3.1.3	In case of fire 15	5.8	Pilot seats for the driver's and front passenger's seats55
3.2	General 16	5.8.1	Seats (Aguti-Liner).....56
3.3	Road safety..... 17	5.8.2	Seat heater (special equipment).....57
3.4	Towing 18	5.9	Headrests57
3.5	Gas system 19	5.10	Seating arrangement.....58
3.5.1	General instructions..... 19	5.11	Electrical window winder.....58
3.5.2	Gas bottles..... 20	5.12	External mirrors59
3.6	Electrical system 21	5.13	Clipboard/holder (for smartphone/tablet)60
3.7	Water system 21	5.14	Shades for windscreen, driver's window and front passenger's window60
4	Before the journey..... 23	5.15	Bonnet61
4.1	Keys..... 23	5.16	Washer nozzles.....62
4.2	Registration..... 23	5.17	Filling with windscreen washer fluid.....62
4.3	Payload..... 23	5.18	Filling up with diesel63
4.3.1	Terms 24	5.18.1	Fuel filler neck.....63
4.3.2	Calculating the payload 26	5.19	Topping up AdBlue®64
4.3.3	Loading the vehicle correctly 27	5.20	Towing65
4.3.4	Rear garage/rear storage space..... 29	6	Setting up the vehicle67
4.3.5	Double floor 30	6.1	Handbrake.....67
4.3.6	Bike rack (special equipment)..... 30	6.2	Entrance step.....67
4.3.7	Bike/e-bike bike rack (special equipment)..... 32	6.3	Ramps.....67
4.3.8	Load rack (special equipment)..... 34	6.4	Wheel chocks67
4.4	Towing 35	6.5	Supports.....68
4.5	Caravan coupling (special equipment)..... 36	6.5.1	General instructions.....68
4.6	Entrance step..... 37	6.5.2	Steady legs (AL-KO) (partially special equipment)68
4.7	Flue shield..... 39	6.5.3	Electrical steady legs (AL-KO) (special equipment).....69
4.8	TV unit (special equipment) 39	6.6	230 V connection.....71
4.9	Sink and drain basic covers 39	6.7	Refrigerator.....71
4.10	Securing add-on parts 40	6.8	Satellite unit (special equipment).....72
4.11	Securing the manual windscreen shade 41	6.8.1	Satellite unit with manual satellite selection (TeleSat)72
4.12	Securing the electrical windscreen shade 41		
4.13	Gas regulator..... 42		
4.14	Snow chains (special equipment) 43		
4.15	Road safety..... 43		

Contents

6.8.2	Satellite unit with automatic antenna alignment (Teleco).....	73	7.11	Skylights	101
6.8.3	Satellite unit with automatic antenna alignment (Oyster Premium).....	75	7.11.1	Heki skylight.....	102
6.9	Awning (special equipment).....	77	7.11.2	Skylight with snap latch.....	103
7	Living	79	7.11.3	Skylight with fan (special equipment).....	104
7.1	Central locking system (partially special equipment).....	79	7.12	Tables	106
7.2	Conversion door and driver's door	80	7.12.1	Fixed table	106
7.2.1	Driver's door, conversion door, outside.....	81	7.13	Beds.....	107
7.2.2	Driver's door, inside	81	7.13.1	Pull-down bed, manually operated	107
7.2.3	Conversion door, inside.....	82	7.13.2	Pull-down bed, electrically operated (partially special equipment).....	109
7.2.4	Window conversion door (partially special equipment).....	82	7.13.3	Fixed bed, hydraulic height-adjustable (special equipment)	112
7.2.5	Folding insect screen on the conversion door (partially special equipment).....	83	7.13.4	Lying surface of single beds (special equipment).....	113
7.3	External flaps	83	7.14	Shower connection point for external shower (special equipment).....	114
7.3.1	Flap lock with recessed handle	84	8	Gas system.....	115
7.3.2	Garage flap emergency release	84	8.1	General.....	115
7.3.3	Flap lock, square	85	8.2	Gas bottles	116
7.3.4	Flap for the 230 V connection.....	85	8.3	Gas isolator taps	118
7.3.5	Cap for the drinking water filler neck.....	86	8.4	External gas connection (special equipment).....	119
7.4	Furniture flaps	86	8.5	Gas bottle switching facility (special equipment).....	120
7.4.1	Furniture flaps with push button	86	9	Electrical system.....	125
7.4.2	Furniture flaps with pressurised release	87	9.1	General safety instructions.....	125
7.4.3	Furniture flaps / drawers with release handle	87	9.2	Terms.....	125
7.5	Floor compartment cover.....	88	9.3	USB socket (partially special equipment).....	126
7.6	Light switch	88	9.4	12 V power supply.....	127
7.6.1	Entrance area	88	9.4.1	Selector switch for power supply of the multimedia system (special equipment).....	127
7.6.2	Interior	89	9.4.2	Starter battery	128
7.6.3	Wardrobe light	90	9.4.3	Living area battery.....	128
7.6.4	Tube lamp in the rear garage	91	9.4.4	Charging batteries via a 230 V power supply	130
7.7	Light control	91	9.4.5	Charging batteries via the vehicle engine.....	130
7.8	Holder for flat screen.....	93	9.5	Charging booster for the living area battery.....	130
7.8.1	Holder on the column.....	93	9.6	Transformer/rectifier (EBL 223)	131
7.8.2	Wall holder.....	93	9.6.1	Battery separation.....	133
7.8.3	Holder with release lever.....	94	9.6.2	Battery selector switch	133
7.9	Ventilation.....	94	9.6.3	Battery monitor	134
7.10	Windows.....	95	9.6.4	Charging the battery	134
7.10.1	Hinged window	96	9.6.5	Entrance step	134
7.10.2	Sliding window with pressure lock.....	98	9.6.6	Solar charge regulator.....	134
7.10.3	Roman shade and insect screen.....	98	9.7	Panel LT 511.....	135
7.10.4	Roman shades for windscreen, driver's window and front passenger's window.....	99	9.7.1	230 V indicator lamp.....	136
7.10.5	Manual windscreen shade.....	99	9.7.2	12 V main switch	136
7.10.6	Electrical windscreen shade.....	100			

9.7.3	Batteries gauge	137	11.2.6	Draining water (rotary handle with overflow).....	185
9.7.4	Tank gauge.....	138	11.2.7	Emptying the water system.....	185
9.7.5	Alarms.....	138	11.3	Waste water installation.....	187
9.7.6	Temperature display.....	139	11.3.1	Drain cock in the vehicle	187
9.7.7	Switch for water pump	139	11.3.2	Heater for waste water tank and waste water pipes (special equipment).....	188
9.8	Solar installation (special equipment).....	140	11.4	Toilet compartment.....	190
9.9	230 V power supply	141	11.5	Toilet.....	190
9.9.1	230 V connection (CEE socket outlet).....	141	11.5.1	Preparing toilet.....	191
9.9.2	Connecting the 230 V power supply	141	11.5.2	Swivel toilet.....	192
9.10	Fuses.....	143	11.5.3	Emptying the sewage tank.....	193
9.10.1	12 V fuses.....	143	12	Care	195
9.10.2	230 V fuse.....	147	12.1	External care	195
9.11	External socket (special equipment).....	148	12.1.1	General.....	195
9.12	Circuit diagrams.....	149	12.1.2	Washing with a high-pressure cleaner	195
9.12.1	Circuit diagrams, interior	149	12.1.3	Washing the vehicle.....	195
9.12.2	Circuit diagram, exterior.....	152	12.1.4	Windows of acrylic glass.....	196
10	Appliances	153	12.1.5	Entrance step.....	196
10.1	General.....	153	12.1.6	Air suspension.....	197
10.2	Heater and boiler.....	154	12.2	Interior care	197
10.2.1	Models with waste gas vent on the right-hand side of the vehicle.....	154	12.3	Water system	198
10.2.2	Alde hot-water heater and boiler.....	154	12.3.1	Cleaning the water tank.....	198
10.2.3	Wall flue	162	12.3.2	Cleaning the water pipes	199
10.2.4	Electrical floor warming unit (special equipment).....	163	12.3.3	Disinfecting the water system.....	200
10.3	Air conditioning unit (special equipment).....	164	12.3.4	Cleaning the waste water tank.....	200
10.3.1	Truma Aventa air conditioning unit.....	164	12.4	Extractor hood.....	200
10.3.2	Telair	168	12.5	Air conditioning unit	201
10.4	Cooker.....	169	12.5.1	Truma.....	201
10.4.1	Gas cooker	169	12.5.2	Telair.....	201
10.4.2	Gas oven (Dometic) (special equipment).....	171	12.6	Winter care	202
10.4.3	Microwave oven (special equipment).....	173	12.6.1	Preparations	202
10.4.4	Extractor hood (special equipment)	174	12.6.2	Winter operation	202
10.5	Refrigerator.....	174	12.6.3	At the end of the winter season.....	203
10.5.1	Refrigerator ventilation grill	174	12.7	Lay-up.....	203
10.5.2	Dometic MES/AES.....	176	12.7.1	Temporary lay-up.....	203
10.5.3	Refrigerator door locking mechanism.....	179	12.7.2	Winter lay-up.....	204
11	Sanitary fittings	181	12.7.3	Starting up the vehicle after a temporary lay-up or after lay-up over winter.....	206
11.1	Water supply, general.....	181	13	Maintenance	207
11.2	Water system	182	13.1	Official inspections	207
11.2.1	Water tank.....	182	13.2	Inspection work	207
11.2.2	Drinking water filler neck with cap.....	182	13.3	Maintenance work.....	208
11.2.3	Filling the water system	182	13.4	Doors	208
11.2.4	Topping up the water	184	13.4.1	Conversion door.....	208
11.2.5	Closing/opening the overflow.....	184	13.4.2	Driver's door	208
			13.5	Living area battery.....	208
			13.6	Alde hot-water heater	208
			13.6.1	Checking the fluid level.....	209
			13.6.2	Topping up heating fluid.....	209

Contents

13.6.3	Bleeding the heating system.....	210	15.7	Air conditioning unit.....	235
13.6.4	Position of the bleeding valves.....	210	15.7.1	Truma.....	235
13.7	Replacing bulbs, external.....	212	15.7.2	Telair.....	236
13.7.1	Front lights.....	213	15.8	Cooker.....	236
13.7.2	Rear lights.....	215	15.8.1	Gas cooker/gas oven.....	236
13.7.3	Side lights.....	215	15.8.2	Extractor hood.....	237
13.7.4	Types of bulbs for exterior lighting.....	216	15.8.3	Microwave oven.....	237
13.8	Replacing bulbs, internal.....	216	15.9	Refrigerator.....	237
13.8.1	Light with LED.....	217	15.9.1	General.....	237
13.9	AL-KO rear axle.....	217	15.9.2	Dometic MES/AES.....	239
13.10	Spare parts.....	218	15.10	Water supply.....	240
13.11	Vehicle identification plate.....	219	15.11	Body.....	241
13.12	Warning and information stickers.....	219			
14	Wheels and tyres.....	221	16	Special equipment.....	243
14.1	General.....	221	16.1	Weight details for special equipment.....	243
14.2	Tyre selection.....	222	17	Technical data.....	245
14.3	Tyre specifications.....	223	17.1	View of ground plans.....	245
14.4	Handling of tyres.....	223	17.2	Table of linear measures / sleeping places.....	246
14.5	Changing wheels.....	223	18	Helpful notes.....	247
14.5.1	General instructions.....	223	18.1	Traffic rules in foreign countries.....	247
14.5.2	Tightening torque.....	225	18.2	Help on Europe's roads.....	247
14.5.3	Changing a wheel.....	226	18.3	Gas supply in European countries.....	248
14.6	Spare wheel support (special equipment).....	227	18.4	Toll regulations in European countries.....	248
14.6.1	Spare wheel support in the rear garage.....	227	18.5	Tips on staying overnight safely during travel.....	249
14.7	Tyre pressure.....	227	18.6	Tips for winter campers.....	249
15	Troubleshooting.....	229	18.7	Travel checklists.....	250
15.1	Braking system.....	229	19	Inspection plan.....	253
15.2	Air suspension.....	229			
15.3	Satellite unit.....	230			
15.4	Electrical system.....	231			
15.5	Gas system.....	233			
15.6	Heater/boiler.....	234			
15.6.1	Alde heater/boiler.....	234			

Please read this instruction manual completely before using the vehicle for the first time!

Always keep this instruction manual in the vehicle. Also inform all other users of the safety regulations.



▶ The non-observance of this symbol can lead to personal injury.



▷ The non-observance of this symbol can lead to damage being caused to, or inside the vehicle.



▷ This symbol indicates recommendations or special aspects.



▷ This symbol indicates actions which lead to environmental awareness.

This instruction manual contains sections which describe model-specific equipment or special equipment. These sections are specially marked. It may be that your vehicle has not been fitted with this special equipment. In some cases, the actual equipment of your vehicle may therefore be different from that shown in some illustrations and descriptions.

However, your vehicle may be fitted with other special equipment not described in this instruction manual.

Special equipment is described when an explanation is required.

Adhere to the instruction manuals which are separately enclosed.



▷ The details "right", "left", "front" and "rear" always refer to the vehicle in direction of travel.

▷ All dimensions and weight details are "approximate".

Should the vehicle be subjected to damage due to a failure to follow the instructions in this instruction manual, then the guarantee claim is deemed invalid.

Our vehicles are subjected to continuous development. Please understand that we reserve the right to alter the form, equipment and technology.

Therefore, no claims can be made against the manufacturer as a result of the contents of this instruction manual. The equipment which was known and included at the time of going to press is described.

The reprinting, translation and copying, including extracts is not permitted without prior written authorisation from the manufacturer.

1.1 General

The vehicle is constructed in accordance with the latest technology and the recognised safety regulations. Nevertheless, personal injury may result and the vehicle may be damaged if the safety instructions in this instruction manual are not followed.

Before using the vehicle for the first time, equip it with the legally prescribed equipment (e.g. first aid kit, warning vest, hazard warning triangle etc.). Observe the relevant equipment regulations when travelling abroad.

Only use the vehicle in a technically impeccable condition. Follow the instructions in the instruction manual.

Malfunctions which impair the safety of persons or the vehicle should be immediately remedied by qualified personnel. To avoid further damages, observe the duty to avert, minimise or mitigate loss for the user during faults.

Have the vehicle's braking and gas systems inspected and repaired by an authorised specialist workshop only.

Alterations to the body are only to be carried out with the authorisation of the manufacturer.

The vehicle is designed for the exclusive transport of persons. Luggage and accessories may only be transported up to the maximum permissible gross weight.

Observe the test and inspection periods stipulated by the manufacturer.

1.2 Environmental tips



- ▷ Be considerate of the environment.
- ▷ Remember that: All kinds of waste water and household waste are not to be disposed of in drains or in the open countryside.
- ▷ On board, collect waste water only in the waste water tank or – if necessary – in other containers designed for that purpose.
- ▷ Only empty the waste water tank and toilet cassette or sewage tank at disposal stations at the camping or caravan sites, which are especially provided for this purpose. When stopping in towns and communities, observe the instructions at caravan sites or ask where there are disposal stations.
- ▷ Empty waste water tank as often as possible, even when it is not completely full (hygiene).
- ▷ If possible, flush out waste water tank and, if necessary, drainage pipe with fresh water every time it is emptied.
- ▷ Never allow the toilet cassette or sewage tank to become too full. Empty the toilet cassette or sewage tank frequently, at the latest as soon as the level indicator lights up.
- ▷ Separate household waste according to glass, tin cans, plastic and wet waste also when on a journey. Enquire at the town or community authority about disposal points. Household waste is not to be disposed of in waste paper baskets which are situated at car parks.
- ▷ Empty waste bins as often as possible into the containers provided for this purpose. This helps to avoid unpleasant smells and an accumulation of rubbish on board.



- ▷ When parked, do not allow the engine to run more than necessary. When running idle, a cold engine releases more contaminants than usual. The running temperature of the engine is achieved more quickly whilst the vehicle is in motion.
- ▷ Use an environmentally-friendly WC chemical agent for the WC which can also be biologically degraded and only use small doses.
- ▷ When staying in towns and communities for long periods, search for parking areas that are specially reserved for motorhomes. Enquire at the town or community authority about parking spaces.
- ▷ Always leave the parking places in a clean condition.

2.1 Bürstner Warranty Conditions



1. BÜRSTNER GmbH & Co. KG, Weststraße 33, 77694 Kehl (Guarantor) grants a 10-year water ingress warranty on vehicles manufactured from model year 2019 onwards, up to a maximum mileage of 120,000 km and that the following components of the caravan or motorhome are sealed in such a way that there is no ingress of moisture from the outside to the inside (interior) during normal, contractual and non-commercial use of the vehicle.

Exterior connecting seams:

- Roof/side wall
- Roof/rear wall
- Roof/driver's cabin
- Walls/underbody
- Chassis/underbody

Outer seal seams between built-in parts and the cut-outs of the body:

- Doors
- Windows
- Service and garage flaps
- Skylights
- Water filling devices
- Power supply flaps

The party covered by the warranty is responsible for proving that the vehicle is covered by the warranty.

2. In the event of proof of a warranty claim due to faulty sealing (cf. Point 1.), the guarantor is exclusively obliged under these warranty conditions to repair the affected vehicle parts free of charge or to replace the affected parts, depending on what the guarantor considers necessary to remedy the water ingress. The required work shall be carried out by the guarantor or by an authorised workshop in accordance with the guarantor's guidelines. Should additional costs arise while remedying the water ingress due to installations or other changes to the vehicle compared to the original condition, these shall be borne by the guarantor. The cost of warranty work carried out by neither the guarantor nor one of the guarantor's authorised workshops is non-refundable, irrespective of the existence of a warranty claim. The party covered by the warranty shall not be entitled to other claims under this warranty, in particular regarding subsequent delivery, withdrawal from the purchase contract, price reduction or compensation for damages (including consequential damages), as well as compensation for direct or indirect, material or immaterial consequential damages. Excluded are e.g. claims for compensation for transport or travel costs, towing costs, loss of earnings or holiday cancellation, as well as compensation for futile expenditure. The legal rights of the party covered by the warranty with regards to its seller remain unaffected by this warranty. The legal rights of the party covered by the warranty with regards to its seller remain independent of claims under this warranty.

3. Depending on which occurs earlier, the warranty period begins either on the date of first registration or on the handover of the vehicle to the original purchaser, but no later than one year after the first delivery of the vehicle to the dealer.
It applies for the duration of the vehicle's usability, but no longer than 10 years or up to a maximum mileage of 120,000 km, whichever occurs earlier. Change of ownership of the vehicle does not affect the warranty. The warranty shall expire if the yearly inspections required in accordance with Point 4. are not carried out. The performance of warranty work does not extend the warranty period, nor does it result in the period starting anew.
4. The successful assertion of a warranty claim is dependent on the vehicle undergoing a yearly water ingress test at a BÜRSTNER authorised workshop. This inspection shall be carried out each year within the 11th to 13th month after the beginning of the warranty period (cf. Point 3.). The costs of carrying out the water ingress test shall be borne by the party covered by the warranty. Claims under this warranty by the party covered by the warranty are only valid if the performance of the yearly inspections has been properly verified by a BÜRSTNER authorised workshop.
This includes an inspection record filled out by the BÜRSTNER authorised dealer. Proof of the regular performance of water ingress tests shall be provided by the party covered by the warranty.
5. The occurrence of water ingress, or moisture indicative of water ingress, shall be reported by the party covered by the warranty to a BÜRSTNER authorised workshop, in writing, within 15 days of becoming aware of the issue. Knowledge is equivalent to grossly negligent and negligent ignorance. Compliance with the 15-day deadline is dependent on receipt of the notification at a BÜRSTNER authorised workshop. The notification shall be attached to the warranty document. If the water ingress is not reported correctly and in due time, no claims under this warranty are possible.
6. The necessity, method and scope of remedying the water ingress is at the sole discretion of the guarantor or its authorised workshops.
7. Warranty claims are excluded in the event of:
 - Forces of nature (e.g. floods, hail, etc.) and animal damage of any kind.
 - Damage resulting from an accident.
 - Water ingress due to conversions or additions to the vehicle that were not carried out by a BÜRSTNER authorised workshop.
 - Water ingress due to improper damage repairs that were not carried out by a BÜRSTNER authorised workshop.
 - Damage to the outer shell discovered during inspections that was not repaired immediately by the party covered by the warranty.
 - Aluminium corrosion that cannot be attributed to water ingress.
 - If the vehicle is modified using spare parts that have not been authorised by BÜRSTNER, and a warranty claim arises as a result.
 - Condensation due to insufficient ventilation.
 - Improper, non-contractual handling and use of the vehicle.

- Damage due to incorrect use of care products or cleaning agents (see “Care” instructions in the instruction manual.)
 - Damage due to non-compliance with the instruction manual or the manufacturer’s repair and maintenance instructions.
 - All other damages that are not the responsibility of the guarantor or an authorised workshop of the guarantor.
8. Water ingress tests are subject to a fee. The costs of the inspections shall be paid by the party covered by the warranty (cf. Point 4).
9. As far as legally permissible, the exclusive place of jurisdiction shall be Kehl, Germany. The place of performance for all claims under this Warranty is Kehl. This warranty is governed exclusively by the law of the Federal Republic of Germany. This applies regardless of the place of residence or business of the party covered by the warranty.

2.2 Proof of water ingress tests

Providing proof



- ▷ The annual water ingress tests are a prerequisite for the weatherproof guarantee of the housing body.

It is mandatory that the inspection record is filled in completely, entered in the online system, and printed out for you after each carried out test by your dealer.

2.2.1 Vehicle data

The following inspection records apply exclusively to the vehicle:

Datum	Entry
Model, type	
Chassis number	
Key no.	
First registration / date of handover	
Purchased from company	

2.2.2 Water ingress test (certificates)

12 months _____	
Stamp of the Bürstner dealer	
Date	Signature

24 months _____	
Stamp of the Bürstner dealer	
Date	Signature

36 months _____	
Stamp of the Bürstner dealer	
Date	Signature

48 months _____	
Stamp of the Bürstner dealer	
Date	Signature

60 months _____	
Stamp of the Bürstner dealer	
Date	Signature

72 months _____	
Stamp of the Bürstner dealer	
Date	Signature

84 months _____	
Stamp of the Bürstner dealer	
Date	Signature

96 months _____	
Stamp of the Bürstner dealer	
Date	Signature

108 months _____	
Stamp of the Bürstner dealer	
Date	Signature

Date: August 2018

Chapter overview

This chapter contains important safety instructions. The safety instructions are for the protection of persons and property.

3.1 Fire prevention

3.1.1 Avoidance of fire risks



- ▶ Never leave children in the vehicle unattended.
- ▶ Keep flammable materials clear of heating and cooking appliances.
- ▶ Halogen lamps can get very hot. When the light is switched on, there must always be a safety distance of 30 cm between light and flammable objects. Fire hazard!
- ▶ Never use portable heating or cooking appliances.
- ▶ Only authorised qualified personnel may make changes to the electrical system, gas system or appliances.

3.1.2 Fire-fighting



- ▶ Always carry a dry powder fire extinguisher in the vehicle. The fire extinguisher must be approved, tested and close at hand.
- ▶ Have the fire extinguisher tested at regular intervals by authorised qualified personnel. Observe the date of testing.
- ▶ Depending on the equipment, the fire extinguisher is included in the scope of delivery.
- ▶ Always keep a fire blanket near the cooker.

3.1.3 In case of fire



- ▶ Evacuate all passengers.
- ▶ Cut off the electrical power supply and disconnect from the mains.
- ▶ Close regulator tap on the gas bottle.
- ▶ Sound the alarm and call the fire brigade.
- ▶ Fight the fire if this is possible without risk.



- ▷ Acquaint yourself with the position and operation of the emergency exits.
- ▷ Keep escape routes clear.
- ▷ Observe the fire extinguisher instructions for use.

3.2 General



- ▶ The oxygen in the vehicle interior is used up by breathing and the use of gas operated appliances. That is why the used air must be replaced permanently. For this purpose, forced ventilation options (e.g. skylights with forced ventilation, mushroom-shaped vents or floor vents) are fitted to the vehicle. Never cover or block forced ventilations from the inside or outside with objects such as e.g. a winter mat. Keep forced ventilations clear of snow and leaves. There is a danger of suffocation due to increased CO₂ levels.
- ▶ Do not use storage spaces or rear garages as places for people or animals to stay or sleep in. These spaces are not forced-air ventilated. There is a danger of suffocation due to oxygen deprivation or exhaust from the heater.
- ▶ Observe the headroom of the doors.



- ▷ As far as the fitted appliances (heater, cooker, refrigerator, etc.) and the base vehicle (engine, brakes, etc.) are concerned, the instruction manuals are authoritative. It is imperative that they be observed.
- ▷ Fitting accessories or special equipment can alter the dimensions, weight and road behaviour of the vehicle. Some of the add-on parts must be entered in the vehicle documents.
- ▷ Only use wheel rims and tyres which are approved for the vehicle. Information concerning the size of the approved wheel rims and tyres is included in the vehicle documents or can be obtained from authorised dealers and service centres.
- ▷ Firmly apply the handbrake when parking the vehicle.
- ▷ If the maximum permissible gross weight of the vehicle exceeds 4 tonnes, wheel chocks must be used when parking on gradients. The wheel chocks are provided as standard for vehicles which have a maximum permissible gross weight exceeding 4 t.



- ▷ When leaving the vehicle, it is imperative that all doors, external flaps and windows are closed.
- ▷ Always carry the legally prescribed equipment (e.g. first aid kit, warning vest, hazard warning triangle etc.) with you. The regulations of the host country apply when travelling abroad.
- ▷ The vehicle may only be driven by drivers who hold a driving licence which is valid for the respective vehicle class.
- ▷ When selling the vehicle, hand over all instruction manuals for the vehicle and the fitted appliances.

3.3 Road safety



- ▶ Before commencing the journey, carry out a functional check of indicating and lighting equipment, the steering and the brakes.
- ▶ If the vehicle has been stationary for a long period (approx. 10 months) have the braking and gas systems checked by an authorised specialist workshop.
- ▶ Before commencing the journey and after short interruptions of the journey, ensure that the entrance step is completely retracted.
- ▶ Before commencing the journey, secure the pull-down bed.
- ▶ Before commencing the journey, open, lock and secure the shades situated on the windscreen and on the driver's and front passenger's windows.
- ▶ Before commencing the journey, rotate all swivel seats in the direction of travel and lock in position. During the journey, the swivel seats must remain locked in place in the direction of travel.
- ▶ Carefully store all moving parts and all loose objects before starting your journey.
- ▶ Before commencing the journey, place and secure the flat screen and screen support in the initial position. If the screen holder is installed in a TV cabinet: close the TV cabinet.
- ▶ Before commencing the journey, remove the loose sink cover (if present) and store it securely in the kitchen unit or wardrobe.
- ▶ Before commencing the journey, fix adjustable tables.
- ▶ During the journey, persons are only to sit on the permitted seats (see chapter 5). The authorised number of seats is stipulated in the vehicle documents.
- ▶ Seat belts must be worn by all passengers.
- ▶ Fasten your seat belts before the beginning of the journey and keep them fastened during the journey.
- ▶ When travelling, secure children under 13 years of age that are smaller than 150 cm, with a suitable and officially approved child restraint system.
- ▶ Only attach the child restraint system to seats that are specified for this purpose. We strongly recommend to install child restraint systems preferably in the second row of seats.
- ▶ **Never** use rearward-facing child restraints on a seat with **activated front airbag**. This may lead to **death** or to **serious injuries** in children.
- ▶ The base vehicle is a commercial vehicle (small truck). Adjust your driving technique accordingly.
- ▶ In case of underpasses, tunnels or similar obstacles, note the total height of the vehicle (including the roof load).
- ▶ In winter, the roof must be free of snow and ice before commencing the journey.



- ▶ Check tyre pressure before a journey or every 2 weeks. Wrong tyre pressure causes excessive wear and can lead to damage or even to tyre burst. You can lose control of the vehicle (see section 14.7).
- ▶ Do not operate the heater at petrol stations. Danger of explosion!
- ▶ Do not operate the heater in closed spaces. Danger of suffocation!



- ▷ Before commencing the journey, distribute the payload evenly within the vehicle (see chapter 4).
- ▷ When loading the vehicle and when taking a rest from driving, in order to load luggage or food, for example, observe the maximum permissible gross weight and axle loads (refer to vehicle documents).
- ▷ Before commencing the journey, close and lock, if possible, all inner doors, adjustable partition walls, drawers and flaps. Engage the refrigerator door securing device.
- ▷ Before commencing the journey, close windows and skylights.
- ▷ Before commencing the journey, close all external flaps and lock them.
- ▷ Before commencing the journey, remove the external supports and retract the corner steadies or steady legs, which are fitted to the vehicle.
- ▷ Before commencing the journey, put the antenna in park position.
- ▷ During the initial journey and each time after changing a wheel, re-tighten the wheel bolts/wheel nuts after 50 km (30 miles). Subsequently inspect them at regular intervals in order to ensure that they are firmly seated. See chapter 14 for tightening torque.
- ▷ Tyres must not be older than 6 years as the material becomes brittle over time (see chapter 14).
- ▷ When using snow chains, the tyres, wheel suspension and steering are subjected to an additional load. When using snow chains, drive slowly (maximum speed 50 km/h) and only on streets which are completely covered with snow. Otherwise the vehicle could be damaged.

3.4 Towing



- ▶ Care is to be taken when connecting and detaching a trailer. Risk of accident and injury!
- ▶ No persons are to be between the towing vehicle and the trailer during positioning for connecting and detaching.

3.5 Gas system

3.5.1 General instructions



- ▶ The operator of the gas system is responsible for the performance of recurring inspections and for complying with the maintenance intervals.
- ▶ Before commencing the journey, when leaving the vehicle or when gas equipment is not in use, close all gas isolator taps and the main regulator tap on the gas bottle.
- ▶ All gas-operated devices (heater, cooker, oven, grill, refrigerator - depending on the equipment) must be switched off for refuelling, on ferries or in the garage. Danger of explosion!
- ▶ Do not use gas-operated devices in closed spaces (e.g. garages). Danger of poisoning and suffocation!
- ▶ Only have the gas system maintained, repaired or altered by an authorised specialist workshop.
- ▶ Have the gas system checked by an authorised specialist workshop according to the national regulations before commissioning. This also applies for not registered vehicles. For modifications to the gas system have the gas system immediately checked by an authorised specialist workshop.
- ▶ The gas pressure regulator, the gas tubes, and the exhaust gas pipes must also be inspected. The gas pressure regulator and the gas tubes must be replaced observing the nationally defined deadlines (the latest after 10 years). The vehicle owner is responsible for seeing that this is carried out.
- ▶ In case of a defect of the gas system (gas odour, high gas consumption) there is danger of explosion! Close regulator tap on the gas bottle immediately. Open doors and windows and ventilate well.
- ▶ If the gas system is defective: Do not smoke; do not ignite any open flames, and do not operate electric switches (light switches etc.). Check the tightness of gas-conducting parts and lines with leakage search spray. Do not check with an open flame.
- ▶ Only the stipulated devices may be connected to internal connections. Do not operate any device outside the vehicle if it is connected to an internal connector.
- ▶ Before using the cooker make sure that there is sufficient ventilation. Open a window or the skylight.
- ▶ Cooking is prohibited during the journey.
- ▶ Do not use gas-operated cooking and baking facilities for heating purposes.
- ▶ If there are several gas devices, each gas device must have its own gas isolator tap. If individual gas devices are not in use, close the respective gas isolator tap.
- ▶ Ignition safety valves must close within 1 minute after the gas flame has extinguished. A clicking sound is audible. Check function from time to time.



- ▶ The built-in gas devices are exclusively meant for use with propane or butane gas or a mixture of both. The gas pressure regulator as well as all built-in gas devices are designed for a gas pressure of 30 mbar.
- ▶ Propane gas is capable of gasification up to -42 °C, whereas butane gas gasifies at 0 °C. Below these temperatures no gas pressure is available. Butane gas is unsuitable for use in winter.
- ▶ Due to its function and construction, the gas bottle compartment is a space which is open to the exterior. Never cover or block up the standard forced ventilations. Otherwise gas that is emitted can not be diverted to the outside.
- ▶ The gas bottle compartment must not be used as storage space.
- ▶ Secure the gas bottle compartment against unauthorised access. To do this, lock the compartment.
- ▶ The regulator tap on the gas bottle must be accessible.
- ▶ Only connect gas-operated devices which have been designed for a gas pressure of 30 mbar.
- ▶ The exhaust gas pipe must be fitted tightly to the heating system and to the vent and must be sealed. The exhaust gas pipe must not show any evidence of damage.
- ▶ Exhaust fumes must be able to escape into the atmosphere unhindered and fresh air must be able to enter unhindered. For this reason, keep the exhaust pipe and intake openings clean and unobstructed (e.g. free from snow and ice). For this reason, no snow walls or aprons may lie against the vehicle.

3.5.2 Gas bottles



- ▶ Handle full or emptied gas bottles outside the vehicle only with closed regulator tap and attached protective cap.
- ▶ Gas bottles are only to be transported within the designated gas bottle compartment.
- ▶ Place the gas bottles in vertical position in the gas bottle compartment.
- ▶ Fasten the gas bottles so that they are unable to turn or tilt.
- ▶ Connect the gas tube to the gas bottle without tension.
- ▶ If the gas bottles are not connected to the gas tube, always place the protective cap on top.
- ▶ Close the regulator tap on the gas bottle before the gas pressure regulator or gas tube are removed from the gas bottle.
- ▶ Depending on the connection, unscrew the gas tube from the gas bottle and screw it on the gas bottle again by hand or using a suitable special spanner. The screw connection on the gas bottle generally has a left-hand thread. **Do not** tighten too firmly.
- ▶ Only use special gas pressure regulators with a safety valve designed for vehicle use. Other gas pressure regulators are not permitted and cannot meet the demanding requirements.



- ▶ Use only 11 kg or 5 kg gas bottles. Camping gas bottles with built-in check valve (blue bottle with max. 2.5 or 3 kg content) are can be used in exceptional cases with a safety valve.
- ▶ Use the shortest possible tube lengths (150 cm max.) for external gas bottles.
- ▶ Never block the floor ventilation openings below the gas bottles.

3.6 Electrical system



- ▶ Only allow qualified personnel to work on the electrical system.
- ▶ Prior to carrying out work on the electrical system, switch off all devices and lights, disconnect the battery and disconnect the vehicle from the mains.
- ▶ Only use original fuses with the stipulated values.
- ▶ Only replace defective fuses when the cause of the defect is known and has been remedied.
- ▶ Never bridge or repair fuses.

3.7 Water system



- ▶ Water left standing in the water tank or in the water pipes becomes undrinkable after a short period. Therefore, before each use of the vehicle, thoroughly clean the water pipes and the water tank. After each use of the vehicle completely empty the water tank and the water pipes.
- ▶ In the case of lay-ups lasting more than a week disinfect the water system before using the vehicle (see chapter 12).



- ▷ If the vehicle is not used for several days or if it is not heated when there is a risk of frost, empty the entire water system. Make certain that the water pump is switched off on the panel. Otherwise, the water pump will overheat and may get damaged. Leave the water taps on in central position. Leave the safety/drainage valve (if there is one) and all drain cocks open. Frost damage to appliances, frost damage to the vehicle and deposits in water-carrying components can be avoided in this way.

Chapter overview

This chapter contains important information which has to be noted before commencing your journey or carrying out any tasks before the journey.

At the end of the chapter there is a checklist which once again summarises the most important points.

4.1 Keys

The following keys are included with your vehicle:

Two keys for

- ignition lock

Two keys for

- driver's door
- conversion door of the body
- fuel tank
- drinking water filler neck
- external flaps

Always deposit a replacement key outside the vehicle. Make a note of the key number. Our authorised dealers and workshops can offer assistance in case of loss.

4.2 Registration

Your vehicle is a motor vehicle subject to registration. Observe national regulations on registration.

Please remember that certain countries require a separate national code sticker in addition to the EU plate.

4.3 Payload



- ▶ Overloading the vehicle and wrong tyre pressure can cause tyres to burst. You can lose control of the vehicle (see section 14.7).
- ▶ The maximum permissible gross weight and the weight including special equipment fitted at the factory (actual weight) is shown in the vehicle documents, but not the weight of the loaded vehicle (see section 4.3.1). For your own safety, we recommend that you have your loaded vehicle (with all passengers, luggage and personal objects) weighed on a public weighbridge before you set out on your journey.
- ▶ Adapt the speed to the payload. The stopping distance is increased if the payload is high.



- ▷ Do not exceed the maximum permissible gross weight (permissible total weight) stated in the vehicle documents and the maximum axle loads as a result of the payload.
- ▷ Built-in accessories and special equipment reduce the payload.

On loading, make sure that the payload's centre of gravity is as low as possible (directly above the floor of the vehicle). Otherwise this may affect the driving characteristics of the vehicle.

Maximum permitted payloads

Description	Load (kg)
Pull-down bed	200
Roof load	90
Rear garage and rear storage space	150
Pull-out in the rear storage space	60
Bike rack, not lowerable	Double/triple 60
Bike rack, lowerable	Double/triple 60
Load rack (SAWIKO)	130

4.3.1 Terms



▷ Technically speaking, the term "mass" has now replaced the term "weight". However, "weight" is still the term more frequent in common use. For better understanding, "mass" is therefore only used in the following sections for fixed formulations.

Maximum permissible gross weight in a laden condition

The maximum permissible gross weight in a laden condition is the weight that a vehicle may never exceed.

The maximum permissible gross weight in a laden condition consists of the **actual weight** and the **payload**.

In the vehicle documents, the manufacturer has specified the maximum permissible gross weight in a laden condition.

Actual weight

The actual weight consists of the mass in ready-to-drive condition and the weight of the special equipment fitted at the factory.

Mass in ready-to-drive condition

The mass in ready-to-drive condition is the weight of the ready-to-drive standard vehicle (excluding special equipment fitted at the factory).

The mass in ready-to-drive condition is made up as follows:

- Unladen weight (mass of the empty vehicle) with factory-installed standard equipment (excluding special equipment fitted at the factory)
- Driver's weight
- Basic equipment weight

Unladen weight includes lubricants such as oils and coolants which have been filled, the on-board tool set and a fuel tank which has been filled up to 90 %.

75 kg are calculated for the weight of the driver, regardless of how much the driver really weighs.

Basic equipment includes all equipment and fluids required for safe and proper vehicle use. The weight of the basic equipment includes:

- A full fresh water system
- A gas bottle filled up to 90 %

- A full heating system
- The power cables for the 230 V power supply
- A full toilet flushing system
- The installation kit for an auxiliary battery if an auxiliary battery can be used

The waste water and sewage tanks are empty.

Example for calculating the basic equipment

Water tank in the ready-to-drive state with 20 l (overflow open)	20 kg
Aluminium gas bottle	+ 11.5 kg
Boiler with 20 l	+ 20 kg
230 V power cable	+ 4 kg
Total	= 55.5 kg

The mass in ready-to-drive condition and the actual weight are shown in the vehicle documents (e.g. 2900/2950 kg).

Payload

The payload is made up as follows:

- Conventional load
- Additional equipment
- Personal equipment



- ▷ The vehicle's payload can be increased by reducing the actual weight. To do this, it is allowed for example to empty the fluid containers or to remove the gas bottles.

You will find explanations on the individual components of the payload in the following text.

Conventional load

The conventional load is the weight specified by the manufacturer for the passengers.

Conventional load means: 75 kg are calculated for every seat specified by the manufacturer, regardless of how much the passengers actually weigh. The driver's seat is already included as part of the mass in ready-to-drive condition and must **not** be calculated as part of the conventional load.

In the vehicle documents, the manufacturer specifies the number of seats.

Additional equipment

Additional equipment includes accessories and special equipment. Examples of additional equipment include:

- Caravan coupling
- Awning
- Bike or motorcycle rack
- Satellite unit
- Microwave oven

Chapter 16 lists the weights of the various items of special equipment; they may also be obtained from the manufacturer.

Personal equipment

Personal equipment includes all items in the vehicle that are not included in the conventional load or in the additional equipment. For example, personal equipment can include the following:

- Foodstuffs
- Crockery
- Television
- Radio
- Clothes
- Bedding
- Toys
- Books
- Toiletries

No matter where kept, personal equipment also includes:

- Animals
- Bikes
- Boats
- Surfboards
- Sports equipment

For the personal equipment, according to the applicable regulations, the manufacturer must use a minimum weight that is determined according to the following formula:

Formula Minimum weight M (kg) = $10 \times N + 10 \times L$

Explanation N = maximum number of people including the driver, as stated by the manufacturer

L = total length of the vehicle in metres

4.3.2 Calculating the payload



- ▶ The payload calculation at the factory is partly based on all-inclusive weights. For safety reasons, the maximum permissible gross weight in a laden condition must not be exceeded.
- ▶ The maximum permissible gross weight and the weight including special equipment fitted at the factory (actual weight) is shown in the vehicle documents, but not the weight of the loaded vehicle (see section 4.3.1). For your own safety, we recommend that you have your loaded vehicle (with all passengers, luggage and personal objects) weighed on a public weighbridge before you set out on your journey.

The payload (see section 4.3.1) is the difference in weight between

- the maximum permissible gross weight in a laden condition and
- the actual weight.

Example for calculating the payload

	Mass in kg to be calculated	Calculation
Maximum permissible gross weight according to vehicle documents	5000	
Actual weight including basic equipment according to vehicle documents	- 4300	

	Mass in kg to be calculated	Calculation
This results in a permissible payload of	700	

The calculation of the payload from the difference between the maximum permissible gross weight in laden condition and the actual weight specified by the manufacturer is however only a theoretical value.

Only if the vehicle is weighed with full tanks (fuel and water), full gas bottles and complete additional equipment on a public weighbridge, can the actual payload be determined.

To do this, proceed as follows:

- First only drive the vehicle on to the weighbridge with the front wheels and have it weighed.
- Then drive the vehicle on to the weighbridge with the back wheels and have it weighed.

The individual values give the current axle loads. These are important for the correct loading of the vehicle (see section 4.3.3). The sum of these values is the current weight of the vehicle.

The actual payload is the difference between the maximum permissible gross weight in laden condition and the weighed vehicle weight.

This can be used to determine the weight that remains for the personal equipment:

- Determine the weight of the passengers and subtract it from the value for the actual payload.

The result is the weight that is permitted for the actual load of the personal equipment.

4.3.3 Loading the vehicle correctly



- ▶ For safety reasons, never exceed the maximum permissible gross weight in a laden condition.
- ▶ Distribute the load evenly on the left and right sides of the vehicle.
- ▶ Distribute the load evenly on both axles. In doing so, observe the axle loads specified in the vehicle documents. Observe the permissible load-carrying capacity of the tyres (see chapter 14).
- ▶ Heavy loads behind the rear axle can reduce the load on the front axle due to the leverage effect ($\frac{1}{2} \frac{l}{L}$). This applies especially to long rear extensions, if a motorbike is transported on the rear carrier or if there is a heavy load in the rear storage space. The release of the front axle negatively affects the driving quality, especially for front-driven vehicles.
- ▶ Store all objects in such a way that they cannot slip.
- ▶ Store heavy objects (awning, tin cans, etc.) close to the axles. Low-lying storage spaces whose doors do not open in the direction of travel are particularly suited for storing heavy objects.
- ▶ Stack light objects (laundry) in the roof storage cabinets.
- ▶ Load the bike rack with bicycles only (max. three units).

Large storage spaces, such as the rear garage, also have room for heavy objects (e.g. motorcycle). This might mean that the axle load on the rear axle is exceeded.

However, the individual axles may not be overloaded under any circumstances. That is why it is important, at which distance to the axles the load is stored.

To distribute the load correctly, you will need a scale, a tape measure, a calculator and some time.

Two simple formulas are needed to calculate the effect of the weight of the load on the axles:

Formulas $A \times G : R = \text{weight on the rear axle}$
 Weight on the rear axle – G = weight on the front axle

Explanation A = distance between storage space and front axle in cm
 G = weight of the load in the storage space in kg
 R = wheelbase of the vehicle (distance between axles) in cm



▷ Measure the external distances horizontally from the centre of the front wheel to the centre of the storage space or to the centre of the back wheel.

Calculating axle loads:

- Multiply the distance between storage space and front axle (A) with the weight of the load in the storage space (G) and divide the result by the wheelbase (R). The result is the weight of the load in the storage space on the rear axle. Make a note of this weight and of the storage space.
- In a second step, subtract the weight in the storage space (G) from the weight calculated beforehand. If the result is a **positive** value (example 1), this means that the load on the front axle is **reduced** by this value. If the result is a **negative** value (example 2), this means that the load on the front axle is **increased**. Make a note of this value, too.
- Calculate all storage spaces of the vehicle in the same way.
- In a last step, add all weights calculated for the rear axle to the rear axle load and add (or subtract) all weights calculated for the front axle to (from) the front axle load.
 How to determine rear axle load and front axle load is described in section 4.3.3.

If the calculated value exceeds the permissible axle load, the load must be distributed in a different way.

If the load on the front axle is too low, the grip of the tyres on the road is reduced (traction). This applies in particular to vehicles with front-wheel drive. In this case, the load must be redistributed, too.

Example calculation

		Example 1	Example 2
Distance to the front axle	A	(A1) 450 (cm)	(A2) 250 (cm)
Weight in the storage space	G	x 100 (kg)	x 50 (kg)
Wheelbase of the vehicle	R	÷ 325 (cm)	÷ 325 (cm)

	Example 1	Example 2
Load on the rear axle (add to the axle load)	138.5 (kg)	38.5 (kg)
Weight in the storage space	- 100 (kg)	- 50 (kg)
Load relief to the front axle (subtract from the axle load)	38.5 (kg)	
Load on the front axle (add to the axle load)		-11.5 (kg)

4.3.4 Rear garage/rear storage space



- ▶ Do not use storage spaces or rear garages as places for people or animals to stay or sleep in. These spaces are not forced-air ventilated. There is a danger of suffocation due to oxygen deprivation or exhaust from the heater.
- ▶ Observe the permissible axle loads and maximum permissible gross weight when loading the rear garage/the rear storage space.
- ▶ The maximum permitted load of the rear garage/the rear storage space is 150 kg. Do not exceed the permissible rear axle load.
- ▶ Observe: If the rear garage or (depending on the model) the rear storage space is **loaded** to its maximum capacity, this will **reduce the load** on the front axle due to the levering action. The driving quality is impaired.



- ▷ Depending on the vehicle equipment, clamping rails with clamping eyelets are mounted in the rear garage or in the rear storage space. Always secure loads onto the clamping eyelets. Always use tightening straps or lashing nets for securing the load, never rubber expanders.
- ▷ When clamping loads, always check that the clamping eyelets are placed tightly in the clamping rails. If the clamping eyelet is not anchored tightly in the clamping rail, the load may slide or loosen during forcible movements of the steering wheel or when braking.
- ▷ Distribute the load evenly. Excessive spot loads can lead to damages of the floor covering.
- ▷ If there is a pull-out present in the rear storage space: Make sure that the pull-out is engaged.
- ▷ Use the supporting system offered by your dealer if two-wheelers are transported in the rear garage.

4.3.5 Double floor



- ▶ Observe the permissible axle loads and maximum permissible gross weight when loading the double floor.



- ▷ Distribute the load evenly. Excessive spot loads can lead to damages of the floor covering.

4.3.6 Bike rack (special equipment)



- ▶ Observe the permissible axle loads and maximum permissible gross weight when loading the bike rack.
- ▶ A total width of 2.55 m must not be exceeded. Adjust the attachments for the bikes accordingly. The overhang to the side and rear must be marked in accordance with the regulations for the country in which you are travelling.
- ▶ Load the bike rack with bicycles only (max. three units).
- ▶ Fasten bicycles using the straps provided and check to see that they are secure after you have driven a few kilometres.
- ▶ Check the secure attachment of the bicycles on the bike rack after the first 10 km and then at each break in the journey.
- ▶ Do not use the bike rack as luggage rack or ladder.



- ▷ The bike rack is only to be used for transporting bicycles.
- ▷ The gross weight specified by the manufacturer must not be exceeded.
- ▷ The identification plate and rear lights must not be covered.
- ▷ The maximum permitted payload of the bike rack is 60 kg.
- ▷ When loading the bike rack, observe the centre of gravity. If the bike rack is only loaded with **one** bicycle, position the bicycle as closely as possible to the vehicle wall.
- ▷ Driving with a folded out bike rack without bicycles is not permitted.
- ▷ Before every journey, check:
 - Is the bike rack without bicycles folded in correctly?
 - Are the bicycles securely fastened to the bike rack using the bike rack belts?

Loading the bike rack with bicycles

When loading the bike rack, observe the centre of gravity. The centre of gravity of the bicycles must be as close as possible to the rear wall of the vehicle. The bike rack should always be loaded from the inside to the outside.

Loading the bike rack correctly:

- Depending on the model, fold the bike rack down or pull it out.
- Place the heaviest bicycle directly against the rear wall.
- Place the lightest bicycles in the centre or on the outside of the bike rack.
- Secure the front and rear wheels of each bicycle with the retaining straps on the bike rack.
- In addition, fasten the outermost bicycle depending on the model of the bike rack on the retaining bracket or retaining arm and to the spacer respectively.

If the bike rack is only loaded with **one** bicycle, position the bicycle as closely as possible to the rear wall.

Bike rack, not lowerable



- ▷ Also read the manufacturer's instruction manual.



Fig. 1 Bike rack, not lowerable

Depending on the model, the bike rack can be used to transport 2 or 3 bicycles comfortably.

Loading the bicycles:

- Fold the swivel clip down.
- Place the bicycles on top and secure them with quick straps.
- Fasten the spacer to the frame of the outermost bicycle.

Bike rack, lowerable



- ▷ Also read the manufacturer's instruction manual.

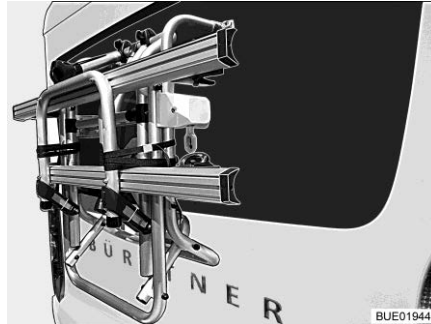

Fig. 2 Bike rack, folded upwards

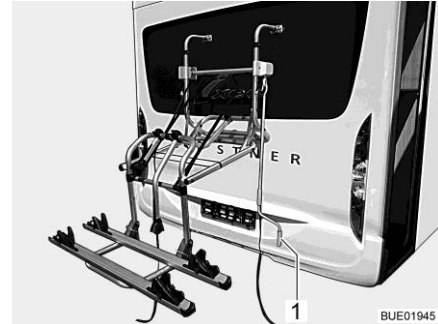

Fig. 3 Bike rack, lowered

The bike rack (Fig. 2) permits to easily transport 2 bicycles. Expansion for 3 bicycles is possible. A winding system can be used to lift and lower the bike rack. The winding system brings the bicycles to gripping height within seconds.

Loading the bicycles:

- Attach the hand crank (Fig. 3,1) to the bike rack and lower the bike rack to gripping height.
- Place the bicycles on top and secure them with quick straps.
- Fasten the bike-block spacer to the frame of the outermost bicycle.
- Use the hand crank to raise the bike rack again.

4.3.7 Bike/e-bike bike rack (special equipment)



- ▶ Observe the permissible axle loads and maximum permissible gross weight when loading the bike rack.
- ▶ A total width of 2.55 m must not be exceeded. Adjust the attachments for the bikes accordingly. The overhang to the side and rear must be marked in accordance with the regulations for the country in which you are travelling.
- ▶ Lock bike rack in drive position before starting your journey.
- ▶ Fasten bicycles using the straps provided and check to see that they are secure after you have driven a few kilometres.
- ▶ Check the secure attachment of the bicycles on the bike rack after the first 10 km and then at each break in the journey.
- ▶ Do not use the bike rack as luggage rack or ladder.



- ▷ The bike rack is designed only to carry bicycles and electrically assisted bicycles (e-bikes, pedelecs).
- ▷ The gross weight specified by the manufacturer must not be exceeded.
- ▷ The identification plate and rear lights must not be covered.
- ▷ The maximum permitted payload of the bike rack is 80 kg.



- ▷ When loading the bike rack, observe the centre of gravity. If the bike rack is only loaded with **one** bicycle, position the bicycle as closely as possible to the vehicle wall.
- ▷ Before fixing bicycles, check that the retaining arms and the wheel-holders of the bike rack are in the correct position. If necessary, adjust the retaining arm or wheel-holder to fit the bicycle.
- ▷ Driving with a folded out bike rack without bicycles is not permitted.
- ▷ Before every journey, check:
 - Is the bike rack without bicycles folded in correctly?
 - Are the bicycles securely fastened to the bike rack using the bike rack belts?
- ▷ If the bicycle rack is equipped with a charging unit:
 - Are the charging cables securely fastened? Otherwise, charging cables can tear off.

Loading the bike rack with bicycles

When loading the bike rack, observe the centre of gravity. The centre of gravity of the bicycles must be as close as possible to the rear wall of the vehicle. The bike rack should always be loaded from the inside to the outside.

Loading the bike rack correctly:

- Place the heaviest bicycle directly against the rear wall.
- Position the lighter bicycle on the outside of the bike rack.
- Secure the front and rear wheels of each bicycle with the retaining straps on the bike rack.
- Fix every bicycle to the retaining arm.

If the bike rack is only loaded with **one** bicycle, position the bicycle as closely as possible to the rear wall.

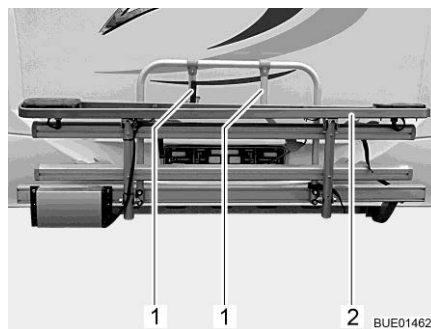

Fig. 4 E-bike bike rack



Fig. 5 Positioning of e-bikes

- Loosen the strap and fold the e-bike bike rack (Fig. 4,2) down.
- Lift the first e-bike onto the bike rack and place it on the wheel-holders (with the front wheel pointing left).
- Swing out the shorter retaining arm (Fig. 4,1) and secure the e-bike's front frame tube (Fig. 5,1) with straps.
- Using the straps, fix both wheels to the wheel-holders.
- Lift the second e-bike onto the bike rack and place it on the wheel-holders (with the front wheel pointing right).

- Swing out the longer retaining arm (Fig. 4,1) and secure the e-bike's front frame tube (Fig. 5,1) with straps.
- Using the straps, fix both wheels to the wheel-holders.
- If necessary, place third e-bike on the wheel-holders and secure it.
- Check that all bicycles are securely fastened.

4.3.8 Load rack (special equipment)



- ▶ Do not exceed the rear axle load.
- ▶ Heavy loads behind the rear axle can reduce the load on the front axle due to the leverage effect ($\frac{l_1}{l_1+l_2}$). This applies especially to long rear extensions, if a motorbike is transported on the rear carrier or if there is a heavy load in the rear storage space. The release of the front axle negatively affects the driving quality, especially for front-driven vehicles.
- ▶ Store the load roadworthy and secure it against falling off.
- ▶ The load may not jut out beyond the maximum width of the vehicle. The lighting and the official licence plate on the load rack may not be covered by the load.
- ▶ Before setting off, check the correct attachment of the load rack on the vehicle and the secure lashing of the transported load.
- ▶ Always mount or dismount the load rack with 2 persons.
- ▶ Only mount the unloaded load rack.



- ▷ The load rack and caravan coupling must not be used simultaneously.



- ▷ The load rack has an EG type approval number. An entry in the vehicle documents is not necessary. Always carry the assembly and instruction manual.
- ▷ Have your dealer or service centre install the load rack.
- ▷ Observe the country-specific regulations.
- ▷ Also read the manufacturer's instruction manual.

The load rack permits transport of a load (e.g. a motorcycle or a motor scooter) weighing up to 150 kg. Special accessories are available for the transport of the load. Our authorised dealers and service centres will be happy to advise you. Always remove the load rack after use.

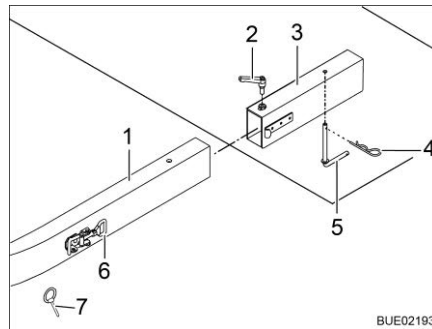

Fig. 6 Attachment to vehicle

A ramp, additional rear lights, and a lighted licence plate holder are included in the scope of delivery. The electrical equipment is connected to the socket on the vehicle via a 13-pole connector.

Attaching/removing the load rack:

- Apply the handbrake.
- Push both side members (Fig. 6,1) of the load rack into the attaching elements (Fig. 6,3) on the vehicle.
- From below, plug the plug lever (Fig. 6,5) through the holes in side member and attaching element, and secure with cotter pin (Fig. 6,4).
- Close clamp fastener (Fig. 6,6) and secure with safety splint (Fig. 6,7).
- Tighten the clamping lever (Fig. 6,2).
- Repeat the procedure on the other side.
- Insert 13-pole connector into the socket on the vehicle.
- Check the function of the lighting.
- Using suitable lashings, tie cargo down at the shiftable clamping eyelets and attaching staples. Use the ramp and corresponding accessories to take along a motorcycle or a motor scooter. Observe the maximum weight.
- Before removing the load rack, remove the load. Remove the load rack in reverse order.

4.4 Towing



- ▶ Care is to be taken when connecting and detaching a trailer. Risk of accident and injury!
- ▶ No persons are to be between the towing vehicle and the trailer during positioning for connecting and detaching.
- ▶ Observe the permissible nose weight and rear axle load of the motorhome. Refer to the vehicle documents for the rear axle load.



- ▷ Trailer with an overrun brake: Do not connect or detach trailer with the overrun brake on.
- ▷ Caravan coupling with detachable ball neck: If the ball neck is mounted incorrectly, there is the danger of the trailer breaking away. Observe the operating manual for the caravan coupling.
- ▷ The tow ball only fits onto the supplied mount. If the tow ball must be replaced, the mount must also be replaced.



- ▷ If the vehicle is equipped with air suspension: The distance between the tow ball of the caravan coupling and the road must be 350 to 420 mm in loaded condition.

The permissible nose weight is:

Model	Permissible nose weight
AL-KO	80 kg

4.5 Caravan coupling (special equipment)



- ▶ When mounting a caravan coupling, see the vehicle documents for information on maximum nose weight and caravan load.
- ▶ Retighten the caravan coupling fixing screws after 1000 operating hours.



- ▷ The load rack and caravan coupling must not be used simultaneously.



- ▷ If the caravan coupling is retrofitted, this must be entered in the vehicle documents. The required documents are enclosed with the caravan coupling.
- ▷ If the caravan coupling was fitted at the factory, this is entered in the vehicle documents. Always keep the appropriate documents in the vehicle.
- ▷ Also read the manufacturer's instruction manual.



Fig. 7 Caravan coupling, rigid



Fig. 8 Caravan coupling, detachable

Entry in the vehicle documents

Have your dealer or service centre install the add-on parts. They will also take care of all the formalities for you.

4.6 Entrance step



- ▶ Before commencing the journey and after short interruptions of the journey, ensure that the entrance step is completely retracted.
- ▶ Do not stand in the direct range of the entrance step while it is being retracted or extended.
- ▶ Do not step on the entrance step until it has extended completely. There is a risk of injury!
- ▶ Do not under any circumstances raise or lower persons or loads with the entrance step.



- ▷ Take note of the different step heights and make certain that the ground is firm and even when exiting.
- ▷ Do not grease or lubricate the pivot bearing and joints of the entrance step (see chapter 12).



- ▷ The button to operate the entrance step is located on the inside of the vehicle in the area of the conversion door.
- ▷ If the entrance step has not been retracted correctly, a red indicator lamp lights up on the dashboard when switching on the ignition.
- ▷ Follow the warning notice on the entrance step.

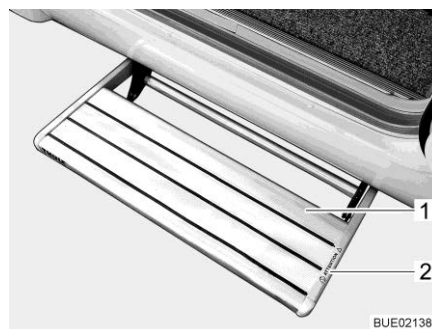

- 1 Entrance step
- 2 Warning notice "Risk of crushing"

Fig. 9 Entrance step

Depending on the model, the vehicles will have an electrically extendable entrance step.

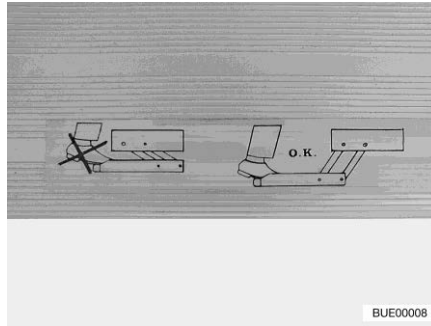

Fig. 10 Warning notice for entrance step

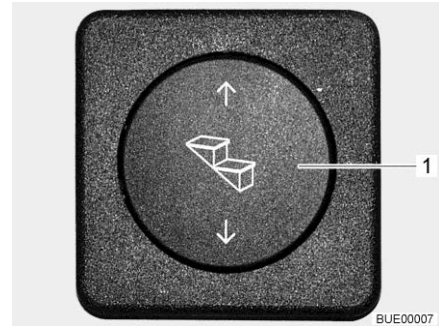

Fig. 11 Operating button for entrance step

Before stepping on the entrance step, fully extend it (Fig. 10).

- Extending:**
- Press the operating button (Fig. 11,1) down and hold it pressed (at least 3 seconds) until the entrance step has extended completely.
- Retracting:**
- Press the operating button (Fig. 11,1) up until the entrance step has retracted completely.

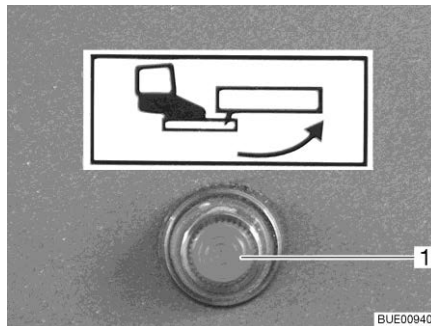

Fig. 12 Indicator lamp

When the ignition is switched on and the entrance step is extended, an indicator lamp (Fig. 12,1) is illuminated on the dashboard.

4.7 Flue shield



- ▷ If a flue shield (Fig. 13,1) is installed on the wall flue: Remove flue shield before setting off.



Fig. 13 Flue shield

4.8 TV unit (special equipment)



- ▶ Before commencing the journey, place and secure the flat screen and screen support in the initial position. If the screen holder is installed in a TV cabinet: Close TV cabinet.
- ▶ Before commencing the journey, ensure that the antenna is in park position. Danger of accidents! Park position means: The antenna points towards the back, is fully lowered and is locked in this position.



- ▷ Further information on positioning the flat screen can be obtained from chapter 7.

4.9 Sink and drain basic covers



- ▶ In the event of an accident or emergency braking, the loose sink (Fig. 14,1) and drain basin covers could injure the occupants of the vehicle. Before commencing the journey, take the loose covers off and store them securely in the kitchen unit or wardrobe.



Fig. 14 Sink cover (example)

4.10 Securing add-on parts



- ▶ In the event of an accident or emergency braking, loose add-on parts could injure the occupants of the vehicle. Before setting off, secure loose add-on parts in the holders provided or stow them in a secure place inside the vehicle.



- ▷ Unsecured flaps and doors can spring open during the journey and damage parts of the interior. Secure all flaps and doors before setting off.

Add-on parts are, for example, inner doors or partition walls. The add-on parts are retained in different ways. To open and close the furniture flaps, see section 7.4.

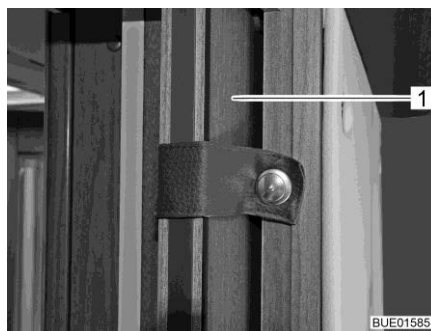

Fig. 15 Sliding door (example)



Fig. 16 Shower partition

Securing add-on parts:

- Secure doors (Fig. 15,1) or partition walls (Fig. 16,1) with the locks or means of securing provided.

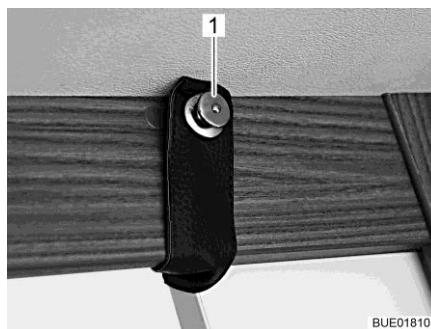

Fig. 17 Pull knob



Fig. 18 Catch with spring

Opening the pull knob:

- Pull at the pull knob (Fig. 17,1).

Closing the pull knob:

- Press the pull knob onto the bottom part.

Opening the catch:

- Compress the spring (Fig. 18,1).

Closing the catch:

- Push add-on part back until the spring engages.

4.11 Securing the manual windscreen shade

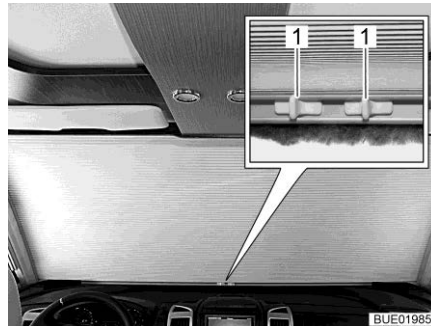

Fig. 19 Manual windscreen shade

- Clench handles (Fig. 19,1).
- Push the windscreen shade upwards until it engages.

4.12 Securing the electrical windscreen shade



- ▷ So that visibility is guaranteed at all times while driving, secure the blind with two securing latches before setting off.

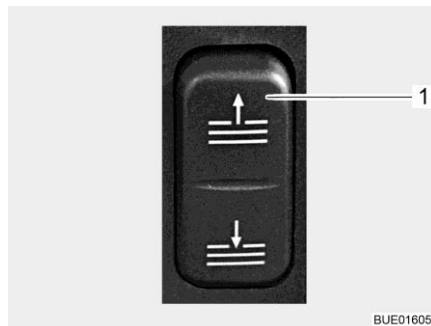

Fig. 20 Switch for windscreen shade

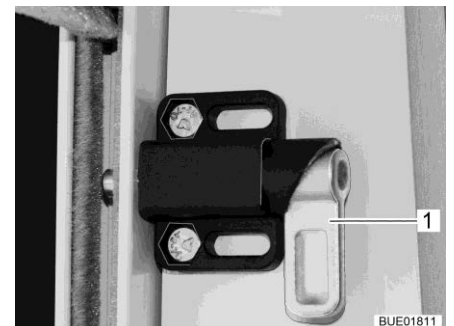

Fig. 21 Securing latch

- Open the windscreen shade. To do this, press the top half of the switch (Fig. 20,1).
- Turn the securing latch (Fig. 21,1) downwards on both sides.



- ▷ See section 7.10.6 for emergency operation.

4.13 Gas regulator



- ▶ Operating gas-operated appliances during the journey is permitted only if the gas system has the relevant equipment. The hose break guard and crash protection unit (CPU) prevent the gas from escaping in the event of an accident.

Depending on the equipment, different gas regulators can be installed in the vehicle.

If a gas regulator other than the one listed below is installed in the vehicle, the regulator tap on the gas bottle and the gas isolator taps must be closed during the journey.

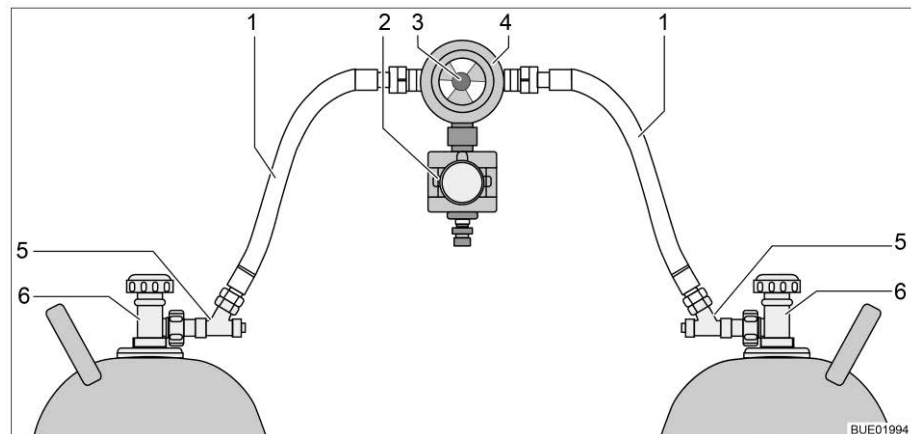

Fig. 22 Gas regulator with CPU and hose break guard

- 1 Gas tube
- 2 Crash protection unit (CPU)
- 3 Knob for manual switching of the gas bottles
- 4 Gas pressure regulator with reversing valve and indicator
- 5 Hose break guard
- 6 Regulator tap on the gas bottle

Gas regulator with CPU and hose break guard

If a gas regulator with crash protection unit (Fig. 22,2) and hose break guard (Fig. 22,5) is installed in the vehicle:

The regulator tap on the gas bottle and the gas isolator taps may remain open during the journey. Gas-operated appliances may be on during the journey.



- ▷ If in doubt, get the relevant information from authorised dealers or service centres.

4.14 Snow chains (special equipment)



- ▷ Only mount snow chains if there is a clearance of at least 50 mm between the tyres and the vehicle body.
- ▷ When using snow chains, the tyres, wheel suspension and steering are subjected to an additional load. When using snow chains, drive slowly (maximum speed 50 km/h) and only on streets which are completely covered with snow. Otherwise the vehicle could be damaged.
- ▷ Observe the fitting instructions issued by the manufacturer of the snow chains.
- ▷ Do not fit snow chains on alloy wheel rims.

Only use suitable snow chains:

Tyre size	Snow chain size
215/70 R 15 C	230
225/75 R 16 C	245

The use of snow chains is subject to the legal regulations of the individual countries.

- Always mount snow chains to the drive wheels.
- After a few metres, check the tension of the snow chains.

4.15 Road safety



- ▶ Check tyre pressure before a journey or every 2 weeks. Wrong tyre pressure causes excessive wear and can lead to damage or even to tyre burst. You can lose control of the vehicle (see section 14.7).

Before commencing the journey, work through the checklist:

Base vehicle

No.	Checks	Checked
1	All vehicle documents are on board	
2	Tyres in proper condition and tyre pressure correct	
3	Vehicle lighting, brake lights and reversing lights function	
4	Oil levels for engine, gearbox and power steering controlled	
5	Coolant and fluid for windscreen washers filled up	
6	Brakes function	
7	Brakes react evenly	
8	When braking, the vehicle remains in the lane	

Housing body, outside

No.	Checks	Checked
9	Awning completely retracted	
10	Roof free of snow and ice (in winter)	
11	External connections and lines disconnected and stored away	
12	External supports removed	
13	Fitted steady legs retracted and fixed in place	
14	Wheel chocks removed and stored away	
15	Entrance step retracted (observe indicator lamp)	
16	External flaps closed and locked	
17	Rear conversion door closed	
18	Overall height of the vehicle including roof rack when loaded measured and noted. Keep the height information close at hand in the driver's cabin	

Housing body, inside

19	Windows and skylights closed and locked	
20	Flat screen secured	
21	Satellite antenna retracted (if built in)	
22	Loose parts and add-on parts stored away or fixed in position	
23	Open storage spaces empty	
24	Store sink and drain basin covers securely	
25	Refrigerator door secured	
26	Refrigerator set to 12 V operation (only required in case of manual power selection)	
27	All drawers and flaps closed	
28	All doors secured	
29	All objects removed from pull-down bed	
30	For pull-down bed with lowerable head section: head section lowered	
31	Pull-down bed secured in top end position	
32	Children's seats only mounted on the seats approved for this purpose	
33	Swivel seat locking device for driver's seat and front passenger's seat locked	
34	Shades in the driver's cabin opened and secured	

Gas system

No.	Checks	Checked
35	Gas bottle firmly fixed in the gas bottle compartment so that it is unable to turn	
36	If the gas bottles are not connected to the gas tube, place the protective cap on top	
37	If there is no supplied crash protection unit: Regulator tap on the gas bottle and gas isolator taps are closed	

Electrical system

38	<p>Check the battery voltage of the starter and living area battery (see chapter 9). If the panel indicates that the battery voltage is too low, the respective battery will need to be recharged. Observe the notes and instructions in chapter 9</p> <p> ▷ Commence journey with fully charged starter and living area batteries.</p>	
----	--	--

Chapter overview

This chapter contains instructions on how to drive the vehicle.

5.1 Driving



- ▶ The base vehicle is a commercial vehicle (small truck). Adjust your driving technique accordingly.
- ▶ Before commencing the journey and after short interruptions of the journey, ensure that the entrance step is completely retracted.
- ▶ A seat belt is fitted for each seat which is permitted for travel. Please keep your seat belt fastened during the journey.
- ▶ Never open your seat belts when travelling.
- ▶ Passengers must remain in the seats provided.
- ▶ The doors must remain locked.
- ▶ Avoid braking with a jerk.
- ▶ If a navigation system is used, only change the destination when the vehicle is stationary. Drive to a car park or stop in a safe area when changing the destination.
- ▶ Do not play DVDs using the monitor of the navigation system during the journey.
- ▶ Always switch off outdoor light/awning light during the journey.



- ▷ Drive slowly on poor roads.
- ▷ Take extreme care when driving onto ferries, crossing uneven roads and driving in reverse. Because of the relatively large overhang, larger vehicles might swing out and "touch ground" in unfavourable conditions. This can cause damage to the underbody or to parts fitted there.



- ▷ If an accident occurs as a result of these instructions not being observed, the manufacturer will not be responsible for damages caused.
- ▷ The safety measures stipulated in chapter 3 have to be observed.
- ▷ If a reversing camera is installed in the vehicle, the camera is automatically switched on when driving in reverse gear.
- ▷ If the vehicle is equipped with the automatic transmission Comfort-Matic from Fiat, please note the following: The acoustic signal described in the instruction manual for Comfort-Matic is not active in our vehicles. No warning tone will sound.

5.2 Reversing camera (partially special equipment)



Fig. 23 Reversing camera with infrared LEDs

A reversing camera (Fig. 23) is installed in the vehicle.

When it is dark, the infrared LEDs of the reversing camera illuminate the field of view.

If the central multimedia/navigation system has been switched on and reverse is engaged, the reversing camera's image is automatically displayed on the LCD monitor.

In order to display the reversing camera's image on the LCD monitor without engaging reverse: switch on the multimedia/navigation system and activate the camera function via the switch on the display of the MMS system.



- ▷ Further information can be obtained in the manufacturer's instruction manual.

5.3 Driving speed



- ▶ The vehicle is equipped with a powerful engine. This means there are sufficient reserves in difficult traffic situations. This high power enables a high maximum speed and requires above-average driving ability.
- ▶ The vehicle provides a large contact surface for wind. A sudden crosswind can be especially dangerous.
- ▶ Uneven or one-sided loading affects road performance.
- ▶ Driving on unknown streets, you may encounter hazardous road conditions and unexpected driving situations. Therefore, in the interest of safety, make sure your driving speed is appropriate to any given driving situation and environment.
- ▶ Adhere to the national legal speed limits.
- ▶ Special equipment such as skylights, awnings, satellite units, bike racks, or similar, create additional area exposed to the wind. If the vehicle is equipped with such special equipment, we recommend to drive at an appropriate speed. In case of doubt, please contact the special equipment's manufacturer.

5.4 Brakes



- ▶ Have defects on the braking system immediately remedied by an authorised specialist workshop.

Before each journey

Before each journey, check by means of a braking test:

- Do the brakes function?
- Do the brakes react evenly?
- Does the vehicle remain in the lane when braking?

5.5 Air suspension AL-KO (special equipment)

5.5.1 General instructions



- ▶ Overloading of the vehicle cannot be observed visually in the case of an air suspension with automatic levelling. Never exceed the axle load nor the maximum permissible gross weight.
- ▶ Never use the air suspension to lift the vehicle for servicing (e.g. changing the wheel).
- ▶ Only raise or lower the vehicle when it is stationary or moving slowly.
- ▶ Only operate the remote control, if people or objects are not in the working area under the vehicle.
- ▶ Do not allow children to play with the system.
- ▶ Only drive at a steady, low speed if there is a fault with the air suspension and have the fault immediately repaired by an authorised specialist workshop.



- ▷ Do not operate the brake pedal during lifting or lowering of the vehicle. This prevents chassis tension.
- ▷ In the case of long periods of inactivity, the vehicle level may gradually become lower. This can damage the air bellows. The following measures can therefore be adopted in the event of long periods of inactivity:
 - Use steady legs.
 - Fill the air bellows once a week with compressed air.

An air suspension keeps the vehicle at the same driving level in every loading condition. Additionally, different functions are operated manually. The increase of ground clearance simplifies e.g. driving onto ferries (bigger gradient angle).

5.5.2 Front and rear axle air suspension



- ▶ Do not exceed the speed limit while the vehicle's level is being changed or when the vehicle is **not** set at the driving level. Once the vehicle is set at the driving level, you may drive at a faster speed.



- ▷ The distance between the tow ball of the caravan coupling and the road must be 350 to 420 mm in loaded condition.

The different functions of the air suspension can be operated manually via the remote control buttons.



- ▷ When the vehicle is stationary, the button functions are only available if the ignition is switched on. When travelling, the button functions are only available up until a particular speed limit.
- ▷ If the speed limit is exceeded, the driving level is controlled automatically.



Fig. 24 Remote control

Button	Description	Speed limit
1	Indicator lamp	-
2	Off-road position	Up to 25 km/h
3	Parking position	Up to 25 km/h
4	Raising the level	Up to 5 km/h
5	Lowering the level	Up to 5 km/h
6	Axle indicator	Up to 5 km/h
7	Driving level	Up to 25 km/h
	Manual operation	Up to 5 km/h
8	Stop button	Up to 25 km/h
9	Automatic level	-
10	Lateral inclination	Up to 5 km/h
11	Lowering the front	Up to 25 km/h
12	Lowering the rear	Up to 25 km/h

The following functions can be selected via the buttons:

Function	Button	Display	Signification
Start the system (switch on the ignition)		LED lights up for a second	System ready
		2 LEDs light up	Vehicle in driving level
Set driving level	 Press shortly	Both LEDs light up	Vehicle is set to driving level
Automatic level ¹⁾	 Press	Button blinks	Vehicle is aligned horizontally
		Button lights up for 10 seconds	Best possible position is reached
	 Press shortly	-	End the function Vehicle is reset to driving level
Axle is selected for manual use	 Press multiple times (approx. 3 seconds), until the desired axle is selected	 Axle's LED lights up	Axle is selected
Lift the vehicle (axle is selected)	 Press until the desired level has been reached	Button blinks	Vehicle is raised
	Release	Button lights up	Level reached
	 Press shortly	Button blinks	Vehicle is raised
		Button lights up	Highest level reached
Lower the vehicle (axle is selected)	 Press until the desired level has been reached	Button blinks	Vehicle is lowered
	Release	Button lights up	Level reached
	 Press shortly	Button blinks	Vehicle is lowered
		Button lights up	Lowest level reached
Off-road position (high driving position)	 Press shortly	Button blinks	Vehicle is raised
		Button lights up	Level reached
Parking position (low driving position)	 Press shortly	Button blinks Beeping noise while the function is active	Vehicle is lowered
		Button lights up	Level reached
Lower the rear (easier to load)	 Press shortly	Button blinks	The rear of the vehicle is lowered
		Button lights up	Lowest possible level reached

Function	Button	Display	Signification
Lower the front (large ground clearance in the rear area)	 Press shortly	Button blinks	The front of the vehicle is lowered
		Button lights up	Lowest possible level reached
Lateral inclination (emptying the tank)	 Press until the desired angle has been reached	Button blinks	Vehicle inclines
		Release	Button lights up Maximum inclination angle has been reached
	 Press shortly	-	End the function Vehicle is reset to driving level
Emergency stop	 Press once (during functional process)	-	All functions are immediately interrupted
	 Press twice	-	System is reactivated
Switch the system off	 Press once	Button lights up	System is switched off
Switch the service mode on/off (vehicle in park but with the ignition still switched on)	 Press shortly	Button lights up	Service mode switched on
	 Press again	Button goes out	Service mode switched off

¹⁾ This function is available for another 6 minutes after the ignition has been switched off



- ▷ Further information can be obtained in the manufacturer's instruction manual.

5.6 Seat belts

5.6.1 General

The vehicle is equipped with seat belts in the living area on the seats for which seat belts are compulsory by law. National regulations apply to fastening of seat belts.



- ▶ Fasten your seat belts before the beginning of the journey and keep them fastened during the journey.
- ▶ Do not damage or trap belts. Have damaged seat belts changed by an authorised specialist workshop.
- ▶ Do not alter the belt fixing devices, automatic seat belt winders and the seatbelt locks.
- ▶ Only use one seat belt for **one** adult person.
- ▶ Do not belt in objects together with persons.
- ▶ Seat belts are not sufficient for persons who are less than 150 cm tall. In these cases use additional restraining devices. Observe test certificate.
- ▶ Only attach the child restraint system to seats that are specified for this purpose. We strongly recommend to install child restraint systems preferably in the second row of seats.
- ▶ After an accident, replace the seat belts (have it replaced).
- ▶ During the journey, do not tilt the backrest too far backwards. Otherwise the functionality of the seat belt is no longer guaranteed.

5.6.2 Fastening the seat belts correctly



- ▶ Do not twist the belt. The belt must be positioned smoothly against the body.
- ▶ When fastening the seat belt, adopt the correct sitting position.

The seat belt is correctly fastened when the lap belt passes below your stomach and across the hip bone. The shoulder belt must pass across the chest and shoulder (not across your neck). The belt must always be taut against your body. Any bulky or padded clothing should therefore be removed before you start your journey.

5.7 Child restraint systems



- ▶ When travelling, secure children under 13 years of age that are smaller than 150 cm, with a suitable and officially approved child restraint system.
- ▶ Only attach the child restraint system to seats that are specified for this purpose. We strongly recommend to install child restraint systems preferably in the second row of seats.
- ▶ Fasten the childrens' seat belts before commencing the journey and make sure that their seat belts are kept fastened during the journey.



- ▶ Use a rear-facing child restraint system ("reboard system") only when the front and side air bags on the passenger side are switched off. Observe the separate operating instructions of the chassis manufacturer and the warning notices in the vehicle. If no rear-facing child restraint system is in use, switch the airbags back on again.
- ▶ Never use rearward-facing child restraint system on a seat with activated front airbag. This may lead to death or to serious injuries in children.

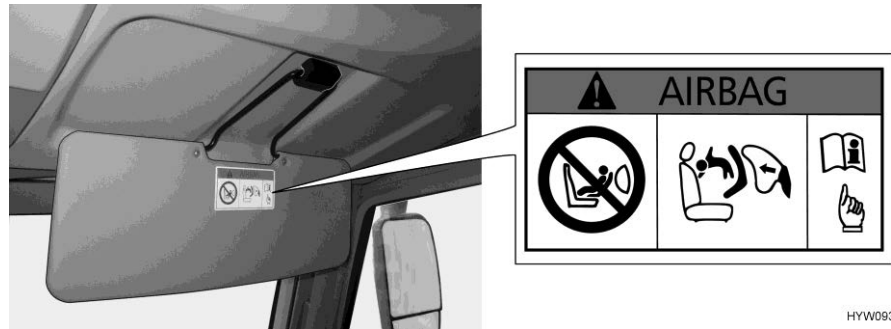

Fig. 25 Warning notice on child restraint system (front passenger's seat sun visor)

Rearward-facing child restraint systems on the front passenger's seat

The front passenger's seat is equipped with an airbag. In the event of an accident, the triggered airbag may cause serious injuries in the child or to its death. A warning notice (Fig. 25) depicting this hazard is attached to both sides of the sun visor.

Refer to the instruction manual of the base vehicle for any information regarding the deactivation of the front passenger airbag.

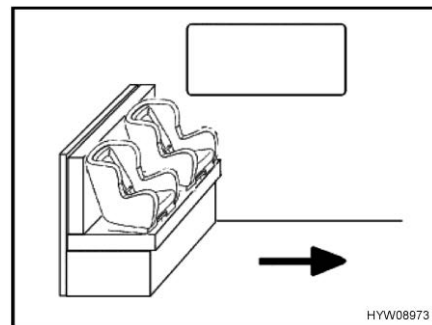

Fig. 26 Child seats on bench

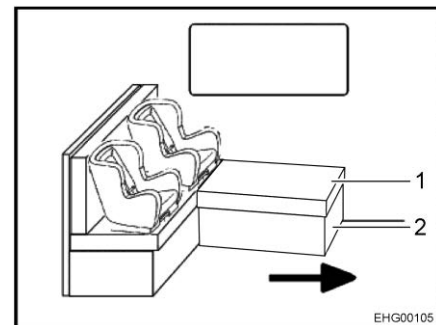

Fig. 27 Child seats on L-shaped bench

Child restraint systems in the living area

The arrow in Fig. 26 and Fig. 27 shows the direction of travel.

On the L-shaped bench, the back cushion on the side wall must be removed when a child seat is fitted.

- Lower the table.
- Remove the cushion (Fig. 27,1) if necessary.
- Fold the chest frame (Fig. 27,2) if necessary.

Child restraint systems are divided into five classes:

Class	Body weight	Approximate age
0	Up to 10 kg	Up to 9 months
0+	Up to 13 kg	Up to 18 months
I	9 kg to 18 kg	9 months to 4 years
II	15 kg to 25 kg	3 years to 7 ½ years
III	22 kg to 36 kg	6 years to 12 years

The following table shows, which child restraint systems can be used on which seats.

Class	Front passenger's seat		Second row of seats (in the opposite direction to travel, if present)	Third row of seats (row of seats in the direction of travel)
	Airbags active	Airbags not active		
0, 0+	X	U	X	U**
I	U*	U	X	U**
II	U	U	X	U**
III	U	U	X	U**
U:	Suitable for "universal" restraint systems which are authorised for this weight class			
X:	Seat is not suitable for children in this weight class			
*	Not authorised if used in a child restraint system directed towards the rear (Reboard system)			
**	Only possible in the respective seat if the distance between the seat and the table is large enough or if the table has been removed			

5.8 Pilot seats for the driver's and front passenger's seats



- ▶ Before commencing the journey, rotate all swivel seats in the direction of travel and lock in position.
- ▶ The seats must remain fixed in position during the journey and are not to be rotated.



- ▷ Before rotating the seats in the pitched vehicle, always apply the hand-brake.



- ▷ The driver's and front passenger's seat are a part of the base vehicle, depending on model and vehicle equipment. In this case the adjustment of the seats is described in the operating manual of the base vehicle.

5.8.1 Seats (Aguti-Liner)

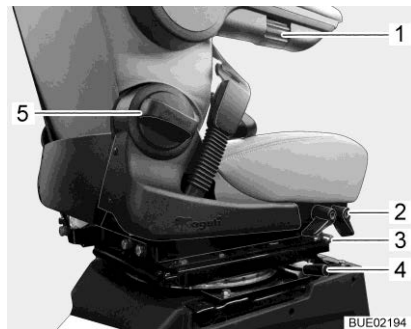

Fig. 28 Seat adjustment

Rotating the seat

The seats can be rotated in any direction.

- Push both armrests upward.
- Slide seat forward.
- Operate the release lever (Fig. 28,4). The latch is released.
- Rotate the seat.

Moving the seat in lengthways direction

Adjust the driver's seat so that the driver can depress the pedals comfortably.

- Pull the bar (Fig. 28,3) upwards.
- Push the seat forwards or backwards.
- Release the bar. The seat must audibly lock into place.

Setting the seat inclination (partially special equipment)

Adjust the seat inclination so that the thighs rest on the seat surface without any pressure.

- Pull the front or rear lever (Fig. 28,2) upwards.
- Bring the seat into the desired inclination position by applying or relieving pressure.
- Release the lever. The seat must audibly lock into place.

Adjusting the backrest

Adjust the angle of the backrest of the driver's seat so that the steering wheel can be held with the arms slightly bent.

- Turn the rotary handle (Fig. 28,5). The backrest inclines forwards or backwards, depending on the rotation direction.

Adjusting the armrest

The height of the armrests can be continuously adjusted.

- Turn the knurled wheel (Fig. 28,1). The armrest inclines upwards or downwards, depending on the rotation direction.

5.8.2 Seat heater (special equipment)



▷ The seat heater only works when the ignition is switched on.

Depending on the equipment level, the driver's and front passenger's seats are equipped with seat heaters which can be continuously adjusted.

The dial to control the heat output is located on the outside of the seat, respectively.



Fig. 29 Seat heater dial

Adjusting the seat heater:

- Depending on the desired heat output, turn the dial (Fig. 29,1) to a position between "0" and "5".
- Turn dial to the position "0" to switch off.

5.9 Headrests

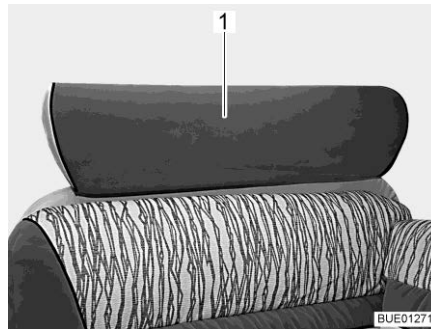

Fig. 30 Bench headrest, one-part

Before commencing the journey, adjust the headrest (Fig. 30,1) so that the back of the head is supported at approximately ear height. Push the headrests upwards or downwards by hand.

5.10 Seating arrangement



- ▶ During the journey, persons are only to sit on the permitted seats. The authorised number of seats is stipulated in the vehicle documents.
- ▶ During the journey sitting on the divans is not permitted.
- ▶ Seat belts must be worn by all passengers.



Fig. 31 Symbol "Do not use seat during the journey"

Seats which may not be used during the journey are equipped with the depicted sticker (Fig. 31).

5.11 Electrical window winder



- ▶ Remove hands and other objects from the window before closing.
- ▶ Even if you leave your vehicle just briefly, remove the ignition key from the steering lock. Otherwise children may be able to operate the window winder and injure themselves.

There is an electrical window winder on the driver's side of the vehicle.

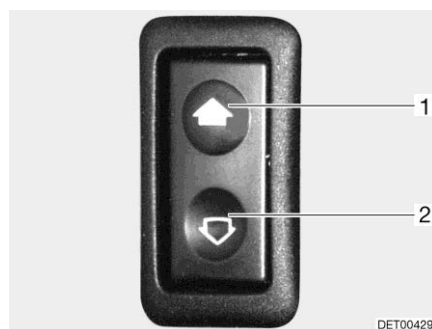

Fig. 32 Switch for electrical window winders

Opening: ■ Press the lower part (Fig. 32,2) of the switch.

Closing: ■ Press the upper part (Fig. 32,1) of the switch.

5.12 External mirrors



Fig. 33 External mirrors

The vehicle is equipped with two electrically adjustable and heated external mirrors (Fig. 33,1).

The switch used to adjust the external mirrors is located on the driver's door or on the left of the dashboard.

The switch for the external mirror heater is located on the driver's door, to the left on the dashboard or on the centre console.

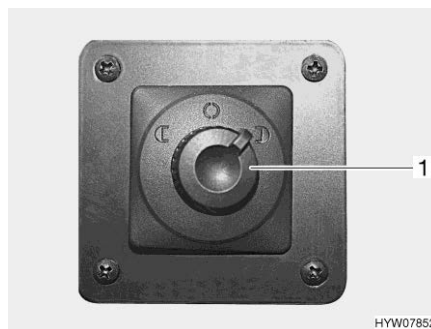

Fig. 34 External mirror adjustment switch



Fig. 35 External mirror heater switch

Adjusting the external mirrors:

- Select the external mirror to be adjusted. To do so, turn the rotary switch (Fig. 34,1) to the left or right.
- Push the switch (Fig. 34,1) into the desired direction.

Switching on the external mirror heater:

- Press the switch (Fig. 35,1) on the dashboard. The switch indicator lamp shows it is in operation.

5.13 Clipboard/holder (for smartphone/tablet)



- ▶ If the driver's attention is distracted from the road, there is a danger of accidents. Do not install or operate the tablet or the smartphone during the journey.

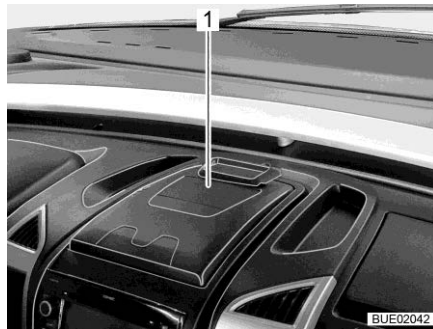

1 Clipboard/holder (for smartphone/tablet)

Fig. 36 Clipboard/holder

A folding clipboard/holder (Fig. 36,1) is installed in the centre of the dashboard. The holder can also be used as a clipboard for paper. Opening a spring-loaded clip enables a smartphone or tablet with a display size up to 10" to be secured.

Fold in the holder if it is not being used.



- ▷ Further information can be found in the instruction manual of the base vehicle.

5.14 Shades for windscreen, driver's window and front passenger's window



- ▶ During the journey, the shades for the windscreen, driver's window and front passenger's window must be open, in a fixed position and secured. The driver's view must not be obstructed.

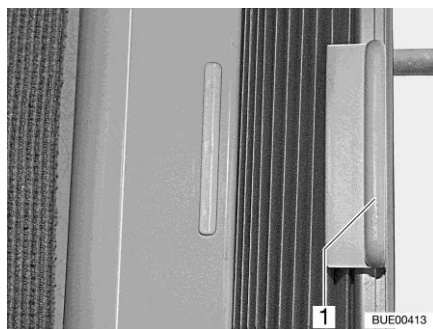

Fig. 37 Roman shade

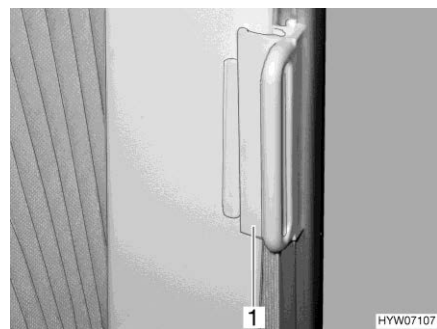

Fig. 38 Lock for Roman shade

Opening and closing: ■ Grasp the handle (Fig. 37,1) of the Roman shade and slide to the left or the right.

Securing: ■ Push the handle (Fig. 38,1) onto the cap. The Roman shade is secured.

5.15 Bonnet



- ▶ When the bonnet is open, there is a risk of injury in the engine compartment.
- ▶ Even if the engine was switched off some time ago, it might still be hot. Danger of burns!
- ▶ Do not work in the engine compartment while the engine is running.
- ▶ The bonnet must be kept firmly closed and locked during the journey. After closing, check whether the lock has engaged. In order to carry this out, pull on the bonnet.

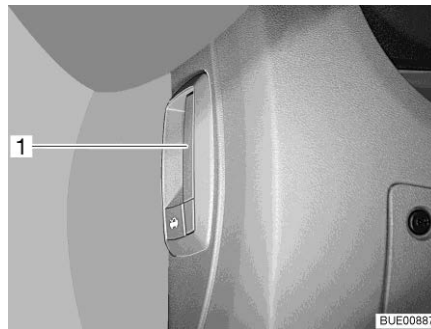

Fig. 39 Release lever for the bonnet (inside the vehicle)

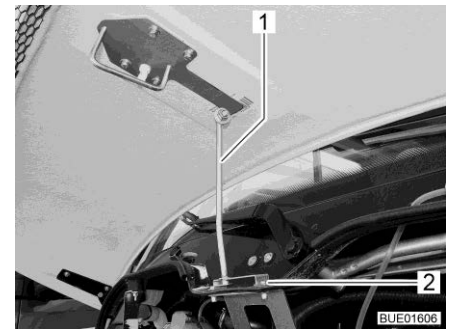

Fig. 40 Bonnet support

- Opening:**
- Pull the lever (Fig. 39,1) on the left under the dashboard or next to it.
 - Move the bonnet up.
- Securing:**
- Unfold the support (Fig. 40,1) and attach to the holder (Fig. 40,2).
- Closing:**
- Fold the support.
 - Move the bonnet upwards until the catch lock engages audibly.
 - Check whether the bonnet is locked correctly. In order to carry this out, pull on the bonnet.

5.16 Washer nozzles

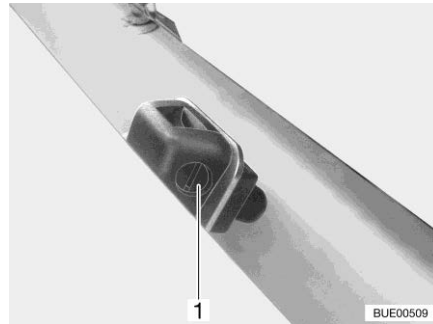

Fig. 41 Washer nozzles

The vehicle has washer nozzles with an adjustable angle of spray.

- Adjusting:
- Use a suitable screwdriver to turn the adjusting screw (Fig. 41,1) until you reach the desired position.

5.17 Filling with windscreen washer fluid

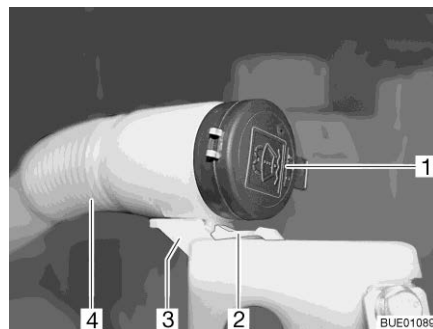

Fig. 42 Washer fluid container filler neck

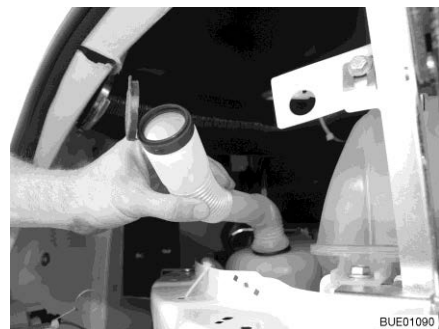

Fig. 43 Filler neck in filling position

- Unlock and open the bonnet.
- Push the handle (Fig. 42,2) down and keep it pressed.
- Pull the flexible hose (Fig. 42,4) to the front and out of the holder (Fig. 42,3).
- Remove the lid (Fig. 42,1) from the filler neck of the washer fluid container.
- Twist the flexible hose in a way so that the filling hole points upwards (Fig. 43).
- Slowly fill in washer fluid.
- Push the lid onto the filler neck of the washer fluid container.
- Push the flexible hose back into the holder and lock it into place.

5.18 Filling up with diesel



- ▶ All gas-operated devices must be switched off for refuelling (heater, cooker, oven, grill, refrigerator - depending on the equipment). Danger of explosion!
- ▶ The cap for the fuel filler neck and for the drinking water filler neck are very similar. Before filling the tank, always check the label.



- ▷ The fuel filler neck is labelled with the word "Diesel".

The fuel filler neck is situated on the exterior of the vehicle, at the front left.

5.18.1 Fuel filler neck



Fig. 44 Fuel filler neck external flap

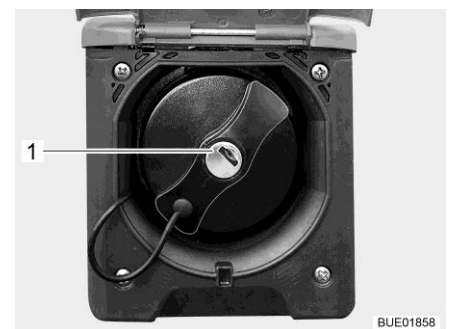

Fig. 45 Cap for the fuel filler neck

- Opening:**
- Swivel the external flap (Fig. 44,1) upwards.
 - Insert the key in the locking cylinder (Fig. 45,1) and turn it in an anti-clockwise direction.
 - Remove the cap.
- Closing:**
- Place the cap on the fuel filler neck.
 - Turn key in a clockwise direction.
 - Remove the key.
 - Check that the cap is fastened securely on the fuel filler neck.
 - Swivel the external flap downwards and press it shut.

5.19 Topping up AdBlue®



- ▶ Store AdBlue® out of the reach of children. Do not store any AdBlue® containers in the vehicle.



- ▷ If the AdBlue® tank is empty, you cannot start the vehicle. If you have driven until the AdBlue® tank has been emptied, the tank must be filled with at least 3.8 litres.
- ▷ Do not dilute AdBlue® with water.
- ▷ Do not top the fuel tank up with AdBlue®.

The base vehicle is equipped with an emission control system that operates with the additive AdBlue®. AdBlue® can be purchased in containers of various sizes or at petrol stations that have an AdBlue® dispenser system.

The additional tank for AdBlue® has a capacity of 15 litres. Audible and visual signals indicate when the reserve has been reached. The first alarm appears when you can still drive 2400 km.

The AdBlue®- tank's filler neck is located underneath the fuel tank's filler neck. The filler neck is closed with a blue lid.



Fig. 46 Filler neck for AdBlue®

Topping up AdBlue®:

- Turn blue lid (Fig. 46,1) in an anticlockwise direction and remove it.
- Top AdBlue® up from container or dispenser system.
- Place blue lid on filler neck and turn in a clockwise direction as far as it will go.
- Immediately remove any liquid that has possible been spilled around the filler neck with a moist cloth.
- Before the next start of the engine, switch ignition on for approx. 10 seconds **without** starting the engine while doing so.



- ▷ Do not dispose of the AdBlue® containers in the domestic waste. Dispose of the empty containers in accordance with the national directives or return them to the point of sale.



- ▷ Further information can be found in the instruction manual of the base vehicle.

5.20 Towing



- ▶ If the ignition key cannot be turned in the ignition lock, do not tow the vehicle. The steering will be locked.



- ▷ If the engine is not running or the power supply is disrupted, the servo assistance for the steering and brakes will not be operational. A considerable amount of force will be required for steering and braking.



- ▷ In addition observe the notes in the operating manual of the base vehicle.
- ▷ National regulations apply to towing.

If the vehicle has to be towed, it should be done on a transporter or trailer if at all possible. If this is not possible, we recommend always using a towing bar for towing. The towing bar must be approved for the weight of the vehicle.

Installing the towing eye

The holder for the towing eye is located behind a cover on the right side of the vehicle's front. Depending on the model, the cover may be rectangular or round.

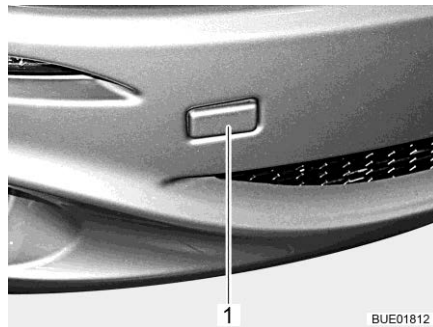

Fig. 47 Cover for the towing eye holder (example)

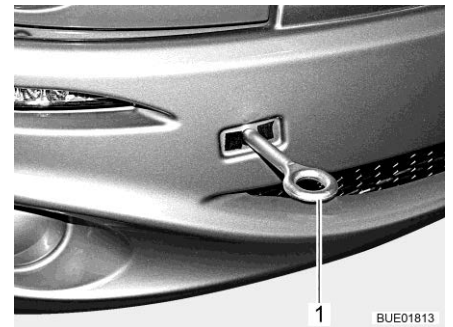

Fig. 48 Towing eye, mounted

- Remove the cover (Fig. 47,1).
- Mount the towing eye (Fig. 48,1) in accordance with the instructions in the operating manual of the base vehicle.

Chapter overview

This chapter contains instructions on how to pitch the vehicle at the campsite.



- ▷ Pitch the vehicle so that it is as horizontal as possible. Use ramps where necessary. Otherwise, the water from the shower tray will not be able to drain properly.
- ▷ Secure the vehicle to prevent it from rolling.
- ▷ Animals (especially mice) can cause great damage to the interior of the vehicle. To prevent this from happening, regularly check the vehicle for damages or animal traces after pitching.

6.1 Handbrake

Firmly apply the handbrake when parking the vehicle.

6.2 Entrance step

In order to exit the vehicle, first fully extend the entrance step. Observe the indicator lamp on the dashboard.

For operating the entrance step, see section 4.6.

6.3 Ramps



- ▷ Ramps are not included in the scope of delivery. Different models are available at the accessories shop.

To enable the vehicle to be parked on the level, ramps can be used for height compensation when the vehicle is parked on a hill or on uneven ground.

6.4 Wheel chocks

When parking the vehicle on slopes or inclines use the wheel chocks.

If the maximum permissible gross weight of the vehicle exceeds 4 tonnes, wheel chocks must be used when parking on gradients. The wheel chocks are provided as standard for vehicles which have a maximum permissible gross weight exceeding 4 t.

6.5 Supports

6.5.1 General instructions



- ▶ The steady legs must not be used to jack up the vehicle in order to work beneath it, e.g. to change a wheel or carry out maintenance work.
- ▶ Whilst the vehicle is in a jacked up position, persons must not lie down under it.



- ▷ Always apply the handbrake before extending the steady legs.
- ▷ Do not use the fitted supports as a vehicle jack. They supports are only for stabilising the parked vehicle to prevent the rear axle from bottoming out.
- ▷ When pitching the vehicle, ensure that the supports are evenly loaded.
- ▷ Before driving away, wind up the supports as far as they can go, fully retract and secure them.



- ▷ When the ground is soft, place a pad or block under the supports in order to prevent the vehicle from sinking into the ground.
- ▷ Pitch the vehicle so that it is as horizontal as possible. Otherwise, the water from the shower tray will not be able to drain properly.

6.5.2 Steady legs (AL-KO) (partially special equipment)

In order to ensure their correct function, clean and grease the interior tubes of the steady legs regularly.

The length of the steady legs can be adjusted according to the model.

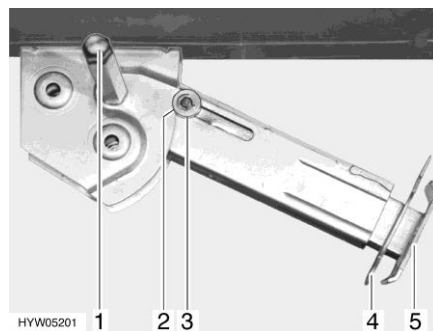

Fig. 49 Steady leg

- Extending:**
- Place the socket spanner on the hexagon nut (Fig. 49,1) and rotate until the steady leg is in a perpendicular downward position.
 - Remove the splint (Fig. 49,4) out of the support foot extension (Fig. 49,5).
 - Extend the support foot extension until it has reached the required length.

- Insert the splint in the support foot extension.
 - Rotate the hexagonal nut until the steady leg rests completely on the ground and the vehicle is in a horizontal position.
- Retracting:**
- Place the socket spanner on the hexagon nut (Fig. 49,1) and rotate until the steady leg is clear of the ground.
 - Remove the splint (Fig. 49,4) out of the support foot extension (Fig. 49,5).
 - Push in the support foot extension (Fig. 49,5) and insert the splint (Fig. 49,4) in the drilled hole in the support foot extension.
 - Rotate the hexagonal nut (Fig. 49,1) with the socket spanner until the steady leg has swung upwards and the guide disc (Fig. 49,3) has completely retracted into the notch (Fig. 49,2).



- ▷ Before commencing the journey, observe the following: Are all steady legs and support foot extensions retracted completely and secured with the splint?

6.5.3 Electrical steady legs (AL-KO) (special equipment)



- ▶ Always observe the electrical steady legs when extending or retracting them.
- ▶ When extending or retracting the steady legs, ensure that no one is in the vehicle. Risk of injury due to unexpected rolling motion.



- ▷ Never extend the steady legs so far that the tyres of the vehicle are not in contact with the ground. This could damage the body and chassis and the brakes will not work.
- ▷ The steady legs are designed only to support the vehicle, not to level it.
- ▷ Steady legs need sufficient ground clearance to be able to fold out vertically.
- ▷ If the vehicle is equipped with air suspension, follow the indications for extending and retracting. Otherwise, the motor of the steady legs can become overloaded.



- ▷ The electrical steady legs can only be operated with the ignition switched off.
- ▷ If the remote control is not operated for two minutes after the controller has been activated, the controller automatically switches off.
- ▷ When a key on the remote control is pressed, the indicator lamp flashes.
- ▷ If the steady legs are extended and the ignition is switched on, a pulsating warning tone is heard. The warning tone stops after the ignition has been switched off.

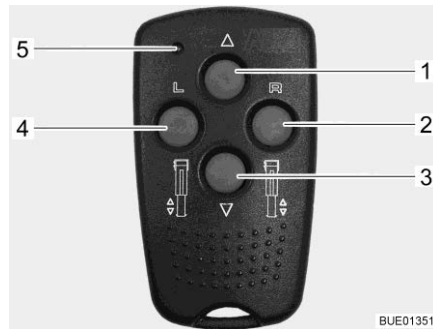

Fig. 50 Remote control for electrical steady legs

Button functions

- Preselection: Steady leg left (Fig. 50,4)
- Preselection: Steady leg right (Fig. 50,2)
- Retracting steady leg (Fig. 50,1)
- Extending steady leg (Fig. 50,3)

Each time a button is pressed, the control LED (Fig. 50,5) flashes.



Fig. 51 Push-button to activate remote control

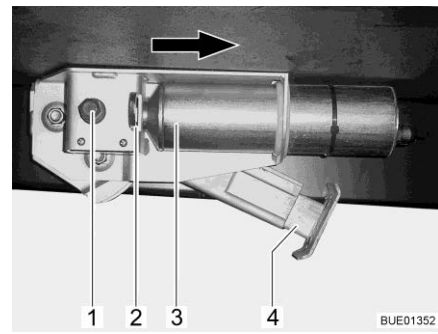

Fig. 52 Electrical steady leg on vehicle



- ▷ Do not extend the steady leg to the end position without it being in contact with the ground.

Extending:

- If the vehicle is equipped with air suspension: First lower the air suspension (see section 5.5), then extend the steady legs.
- Press the push button (Fig. 51,1) for approx. 2 seconds until a brief sound is emitted. The steady legs control is now activated.
- Press and hold the preselection button for the steady leg side (Fig. 50,2 or 4) for approx. 1 second.
- Within 2 seconds, press the "Extend steady leg" button (Fig. 50,3) and hold it until the support leg (Fig. 52,4) is touching the ground.
- Press the preselection button for the other steady leg side and repeat the procedure.

Retracting:

- If the vehicle is equipped with air suspension: First raise the pressure in the air suspension (see the manufacturer's instruction manual), then retract the steady legs.
- Press the push button (Fig. 51,1) for approx. 2 seconds until a brief sound is emitted. The steady legs control is now activated.

- Press and hold the preselection button for the steady leg side (Fig. 50,2 or 4) for approx. 1 second.
 - Within 2 seconds, press the "Retract steady leg" button (Fig. 50,1) and hold it until the support leg (Fig. 52,4) is fully retracted. Once the support leg is fully retracted, a control signal sounds.
 - Press the preselection button for the other steady leg side and repeat the procedure.
- Changing the remote control battery:
- Remove the rear casing.
 - Change the battery (CR2032). Observe the correct polarity ("+" to the outside).



- ▷ The battery must be changed if the control LED flashes more slowly or if it goes out.

Emergency operation

If the electric drive breaks down, the steady legs can be moved with the hand crank.

Extending/retracting:

- Press the securing bracket (Fig. 52,2) inwards.
- Push the motor (Fig. 52,3) in the direction indicated as far as it will go.
- Extend or retract the steady leg like a mechanical steady leg via the hexagonal nut (Fig. 52,1).

When the fault has been rectified: Push the motor in the opposite direction of the arrow to its initial position. Pull out the securing bracket (Fig. 52,2) until it engages.



- ▷ Further information can be obtained in the manufacturer's instruction manual.

6.6 230 V connection

The vehicle can be connected to a 230 V power supply (see chapter 9).

6.7 Refrigerator



- ▶ If the refrigerator is set to 12 V operation, it will constantly consume current. Therefore, switch over to gas operation when the vehicle engine is **not** running, and the vehicle is **not** connected to the 230 V power supply.

In the case of appliances with automatic power selection, the 12 V operation of the refrigerator will only be selected in the automatic mode when the vehicle engine is running.

In the case of appliances with manual power selection: When the vehicle engine is switched off switch the refrigerator to 230 V operation or gas operation.

6.8 Satellite unit (special equipment)



- ▶ Before commencing the journey, ensure that the antenna is in park position. Danger of accidents!



- ▷ Before switching on the satellite unit, make sure that there is no obstacle in the way, e.g. a branch or the garage roof, while erecting the antenna.
- ▷ Move the antenna into parking position in the event of strong wind (above 80 km/h).
- ▷ Do not wash a vehicle with a satellite antenna in a brush washing system, nor in a vehicle washing installation, nor with high-pressure cleaners.
- ▷ In the event of backward shipping, e.g. by truck or train, secure antenna against unintentional erection.



- ▷ The vehicle must be still during the satellite search. Do not walk through the vehicle.
- ▷ Satellite reception is only possible, when the antenna is positioned in direct line of sight of the chosen satellite and the view is not blocked in any way.
- ▷ Further information can be obtained in the device manufacturer's instruction manual.

6.8.1 Satellite unit with manual satellite selection (TeleSat)

The selection of the desired satellite is carried out on the operating panel of the unit. The automatic advance unit ensures that the antenna is precisely aligned to the desired satellite.

When switching on the unit, the antenna is extended automatically. When switching off the unit and when starting the vehicle engine, the antenna is retracted automatically.

The satellite unit is operated via the operating panel. When the antenna is moving (retracting/extending or satellite search), this is indicated by an animation on the display.

The operating panel changes into standby mode after a few seconds without any operation.

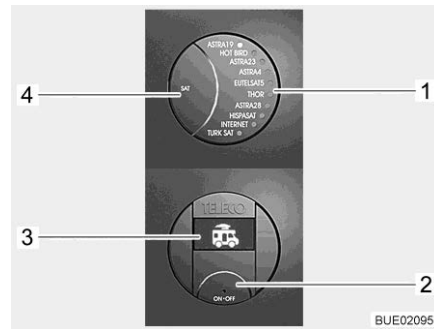

- 1 LED indicator of the selected satellite
- 2 On/Off button
- 3 Display
- 4 SAT button

Fig. 53 Operating panel (TeleSat)

Switching on the unit:

- Press the On/Off button (Fig. 53,2). The LED indicator of the selected satellite (Fig. 53,1) and the background lighting of the buttons are lit. The symbol of the vehicle with retracted antenna appears on the display (Fig. 53,3).
- Press the On/Off button (Fig. 53,2) again. The system has been switched on. If the antenna had been retracted, it will now extend to operating position. If the LED of the desired satellite (Fig. 53,1) is already flashing, wait a few seconds. The antenna automatically aligns with this satellite (the last satellite position is saved after switching off). When the unit has found the satellite, the LED (Fig. 53,1) is lit permanently and "SAT OK" is shown on the display (Fig. 53,3).
- Switch on the SAT receiver and select the desired television channel.

Choosing a satellite:

- Press the SAT button (Fig. 53,4) repeatedly until the LED (Fig. 53,1) indicates the desired satellite. The antenna automatically aligns with this satellite. When the unit has found the satellite, the LED (Fig. 53,1) is lit permanently and "SAT OK" is shown on the display (Fig. 53,3).

Switching off the unit:

- Press the On/Off button (Fig. 53,2). The LED indicator of the selected satellite (Fig. 53,1) and the background lighting of the buttons are lit. The currently selected satellite is shown on the display (Fig. 53,3).
- Press the On/Off button (Fig. 53,2) again. The antenna retracts. When the antenna has been fully retracted, the symbol of the vehicle with retracted antenna is shown on the display. The system changes to the standby mode after a few seconds.

6.8.2 Satellite unit with automatic antenna alignment (Teleco)

The satellite unit is equipped with an automatic advance unit. This automatic advance unit ensures that the antenna is aligned precisely.

When switching on the unit, the antenna is extended automatically. When switching off the unit or when starting the vehicle engine, the antenna is retracted automatically.

When the desired TV programme is chosen, the corresponding satellite is selected and aimed at automatically.

The satellite unit is operated via remote control. Optionally, a simplified remote control is available.



Fig. 54 Remote control

- 1 Television on/off button
- 2 AUTO button (advance unit and television on/off)
- 3 INPUT button (selection of the signal source)
- 4 Programme selection buttons

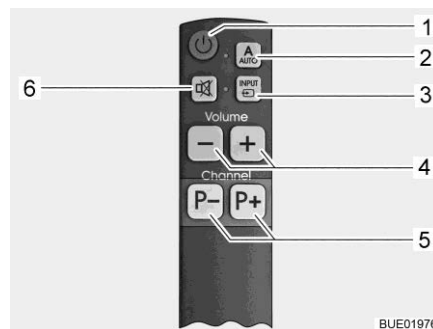

Fig. 55 Simplified remote control (optional)

- 1 Television on/off button
- 2 AUTO button (advance unit and television on/off)
- 3 INPUT button (selection of the signal source)
- 4 Volume buttons
- 5 Programme selection buttons
- 6 Mute button

Switching on the unit:

- Press the AUTO button (Fig. 54,2 or Fig. 55,2) for 1 second. Thus, the television and the advance unit are switched on.

If the antenna had been retracted, it will now extend to operating position. The antenna then automatically starts searching for the satellite suitable for the set TV programme.

When the unit finds the satellite, the TV programme appears automatically.

Choosing a TV programme:

- Press the programme selection buttons (Fig. 54,4 or Fig. 55,5) until the desired TV programme has been selected.

The antenna automatically searches for the suitable satellite.

When the unit finds the satellite, the TV programme appears automatically.

Choosing the signal source:

- Press the INPUT button (Fig. 54,3 or Fig. 55,3) repeatedly until the desired signal source has been selected.
- To return to the satellite channels display, press the INPUT button (Fig. 54,3 or Fig. 55,3) repeatedly until the signal source DVB-S2 has been selected.

Switching off the unit:

- Press the AUTO button (Fig. 54,2 or Fig. 55,2).

The antenna automatically moves into parking position. When reaching the parking position, this is displayed on the screen.

The television and advance unit switch off after a few seconds.

Operating the unit without using the antenna:

- Press the Television on/off button (Fig. 54,1 or Fig. 55,1). The advance unit is not switched on, the antenna remains in parking position.
- Press the INPUT button (Fig. 54,3 or Fig. 55,3) repeatedly until the desired signal source (e.g. DVD) has been selected.
- Press the Television on/off button (Fig. 54,1 or Fig. 55,1) to switch the television off.

6.8.3 Satellite unit with automatic antenna alignment (Oyster Premium)



- ▷ In the event of a longer stationary period, disconnect the flat screen from the power supply with the flip switch to prevent the living area battery from getting discharged.



- ▷ If the location is adjusted with the help of the list of countries, the satellite search will be accelerated.
- ▷ If the antenna has been retracted by switching on the ignition, it is required to restart the system by switching it off and on.
- ▷ The reception of DVB-T/T2 channels (digital terrestrial television) is only possible if there is a DVB-T/T2 antenna present.

The antenna will automatically be aligned with a pre adjusted satellite if the receiver system is within the reach of this satellite.

When switching on the unit, the antenna is extended automatically. When switching off the unit or when starting the vehicle engine, the antenna is retracted automatically.

When the desired TV programme is chosen, the corresponding satellite is selected and aimed at automatically.

The remote control's basic operating functions are listed here; refer to the manufacturer's separate instruction manual for a full description.

The system is equipped in the factory with list of standard channels as well as lists of favourites. You can change or add to these standard lists manually as desired.

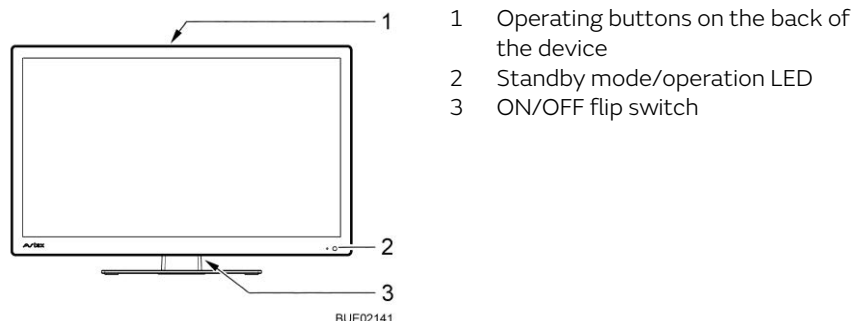

Fig. 56 Operation on the flat screen

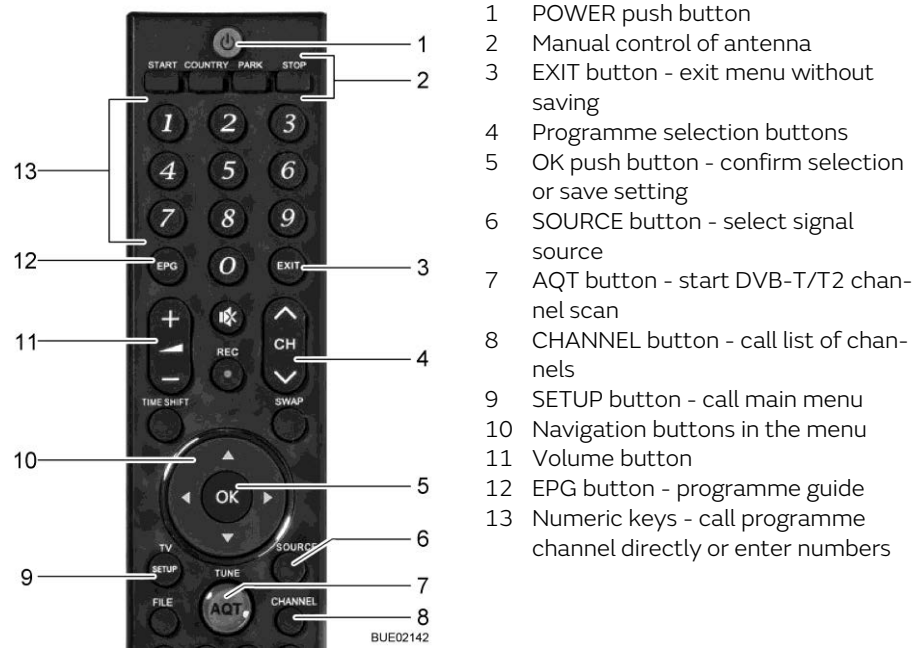

Fig. 57 Remote control

Switching on the unit:

- Set flip switch (Fig. 56,3) on the flat screen's back to ON. The system changes to standby mode. The LED (Fig. 56,2) is lit red.

Further operation is performed via the remote control and the indicators displayed on the flat screen.

- Press the POWER button (Fig. 57,1) on the remote control. The LED (Fig. 56,2) is lit blue.

Choosing a TV programme:

- Press the programme selection buttons (Fig. 57,4 or Fig. 57,13) until the desired TV programme has been selected.

The antenna automatically searches for the suitable satellite.

When the unit finds the satellite, the TV programme appears automatically.

Choosing the signal source:

- Press the SOURCE button (Fig. 57,6) repeatedly until the desired signal source has been selected.

- To return to the satellite channels display, press the SOURCE button repeatedly until the signal source DVB-S has been selected.

Operating the unit without using the antenna:

- Press the PARK button (Fig. 57,2). The antenna moves into parking position.

- Press the SOURCE button (Fig. 57,6) repeatedly until the desired signal source (e.g. DVD) has been selected.

Switching off the unit:

- Press the POWER button (Fig. 57,1) on the remote control. The system changes to standby mode. The LED (Fig. 56,2) is lit red.

- Set flip switch (Fig. 56,3) on the flat screen's back to OFF.

The system is disconnected from the power supply.

The antenna automatically moves into parking position.

6.9 Awning (special equipment)



- ▷ Retract the awning in strong wind, rain or snow.
- ▷ In the case of light rain, shorten one of the support legs so that water can run off.
- ▷ Only retract the awning when the fabric is dry. When the awning must be retracted while the fabric is still wet: Extend the awning as soon as possible, in order to dry out the fabric.
- ▷ Before retracting, remove leaves and coarse dirt from the awning.



- ▷ Only use the awning for protection against the sun.
- ▷ Also read the manufacturer's instruction manual.

Advantages of the awning

The advantages of an awning are:

- The awning provides shade.
- The awning creates a covered vestibule and thus expands the space.
- The vehicle thus becomes more homelike.
- Depending on the equipment, the integrated LED lighting (special equipment) will provide additional light.



Fig. 58 Awning

Putting up the awning:

- Use the manual crank to open up the awning (Fig. 58,1).
- Set up the brackets (Fig. 58,2) when the awning is open.

Chapter overview

This chapter contains instructions about living in the vehicle.

7.1 Central locking system (partially special equipment)



- ▷ The central locking system locks the driver's door, the conversion door, and the external flap of the rear garage of the body.
- ▷ The central locking system has no function, if the battery cut-off switch on the transformer/rectifier is switched off.

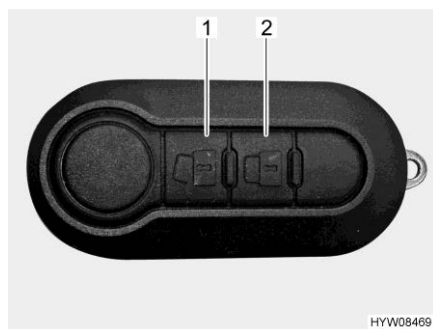

Fig. 59 Remote control for central locking system (2 buttons)

Unlocking doors: ■ Press the  button (Fig. 59,1) once briefly. The door locks are unlatched.

Locking doors: ■ Press the  button (Fig. 59,2) once briefly. The door locks are locked.

Multifunctional remote control for central locking system

Depending on the equipment, the vehicle will be equipped with a remote control with 3 buttons.

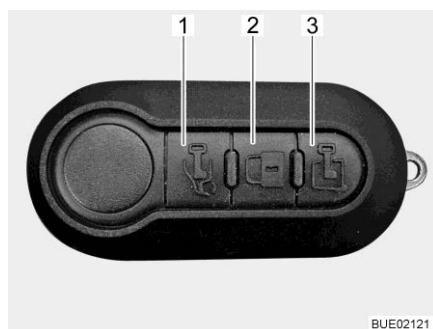



Fig. 60 Multifunctional remote control (3 buttons)

Unlocking driver's door: ■ Press the  button (Fig. 60,1) once briefly. The driver's door is unlocked.

Unlocking conversion door: ■ Press the  button (Fig. 60,3) once briefly. The conversion door is unlocked.

Locking all doors: ■ Press the  button (Fig. 60,2) once briefly. All doors have been locked. If one or more doors have not been correctly closed, the direction indicators will be flashing rapidly.



▷ Further information can be found in the instruction manual of the base vehicle.

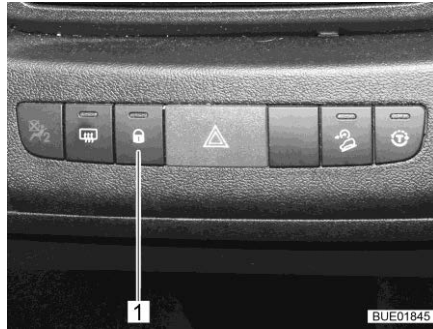

Fig. 61 Central locking system switch

The switch for the central locking system is located on the centre console.

Unlocking: ■ Press the button (Fig. 61,1). The door locks are unlatched.

Locking: ■ Press the button (Fig. 61,1). The door locks are locked. The indicator lamp in the button lights up.

7.2 Conversion door and driver's door



▶ Only drive with locked doors.



- ▷ Locking the doors can prevent them from opening of their own accord, e.g. during an accident.
- ▷ Locked doors also prevent forced entry, e.g. when waiting at traffic lights. However, in an emergency, locked doors make it more difficult for helpers to enter the vehicle.
- ▷ When leaving the vehicle, always lock the doors.

7.2.1 Driver's door, conversion door, outside



Fig. 62 Door lock (driver's door/conversion door, outside)

Depending on the installation situation, the door lock may be installed as shown or rotated by 180°.

- Opening:**
- Insert the key into locking cylinder (Fig. 62,2) and turn until the door lock is unlatched.
 - Return the key to the central position and remove it.
 - Pull on the door handle (Fig. 62,1). The door is open.
- Locking:**
- Insert the key into locking cylinder (Fig. 62,2) and turn until the door lock is engaged.
 - Return the key to the central position and remove it.

7.2.2 Driver's door, inside



Fig. 63 Door lock (driver's door, inside)

- Opening:**
- Pull on the handle (Fig. 63,1). The door lock is unlatched.
- Locking:**
- Close the door.
 - Push the handle (Fig. 63,1) inwards or lock the door via the central locking system (special equipment) (see section 7.1).

7.2.3 Conversion door, inside

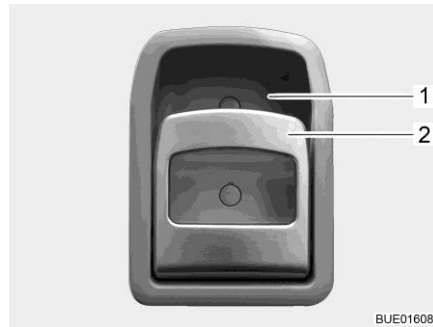

Fig. 64 Door lock (conversion door, inside)

- Opening:** ■ Pull on the handle (Fig. 64,2). The door lock is unlatched or opened.
- Locking:** ■ Press the upper part of the handle (Fig. 64,2) in the direction of the recessed handle (Fig. 64,1). The door lock is locked.

7.2.4 Window conversion door (partially special equipment)

The conversion door window is fitted with a Roman shade.

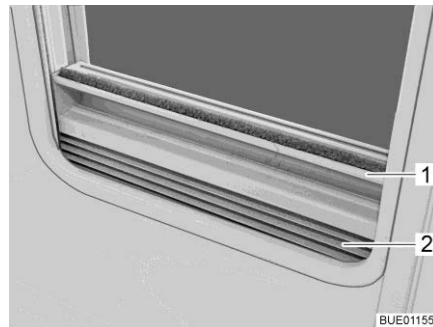

Fig. 65 Roman shade

- Closing:** ■ Grip the Roman shade (Fig. 65,2) in the middle of the holding bar (Fig. 65,1), pull it upwards and then release it at the desired height. The Roman shade will stay at this height.
- Opening:** ■ Grip the Roman shade in the middle of the holding bar and push it down.

7.2.5 Folding insect screen on the conversion door (partially special equipment)



- ▷ Open the insect screen completely before closing the conversion door.



Fig. 66 Insect screen

- Closing:**
- Pull out the insect screen completely by the bar (Fig. 66,1).
- Opening:**
- Push the insect screen into its initial position by the bar (Fig. 66,1).

7.3 External flaps



- ▷ Before commencing the journey, close all external flaps and lock them.
- ▷ To open and close the external flap, open or close all locks that are fitted to the external flap.



- ▷ When leaving the vehicle, close all external flaps.

The external flaps fitted to the vehicle are all fitted with identical locking cylinders. Therefore, all locks can be opened with a single key.

7.3.1 Flap lock with recessed handle



- ▷ To open the external flap, pull all the lock handles fitted to that particular external flap at the same time.

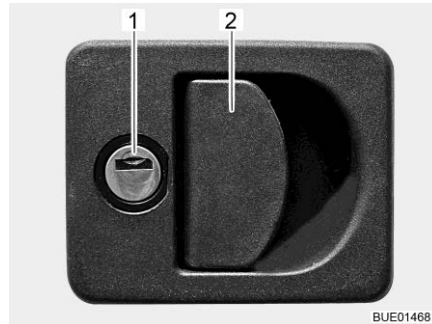

- 1 Locking cylinder
2 Lock handle

Fig. 67 Flap lock with recessed handle

- Opening:**
- Insert key into locking cylinder (Fig. 67,1) and turn a quarter turn. The flap lock is unlatched.
 - Remove the key.
 - Pull on the lock handle (Fig. 67,2). The external flap is open.
- Closing:**
- Firmly close the external flap.
 - Insert key into locking cylinder and turn a quarter turn. The flap lock is locked.
 - Remove the key.

7.3.2 Garage flap emergency release

The garage flap can be opened from the interior using the emergency release. The emergency release is even possible if the garage flap has been locked with the key.



Fig. 68 Garage flap emergency release

- Unlocking the garage flap:**
- Pull both handles of the emergency release (Fig. 68,2).
 - Push the garage flap (Fig. 68,1) outwards.

7.3.3 Flap lock, square

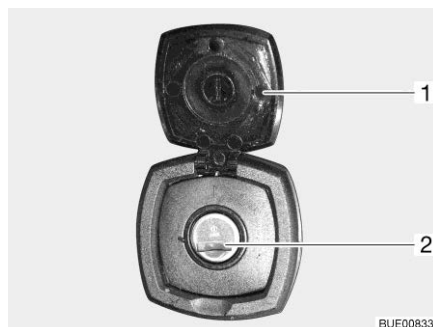

- 1 Cap
- 2 Locking cylinder

Fig. 69 Flap lock, square

- Opening:**
- Open the cap (Fig. 69,1).
 - Insert key into locking cylinder (Fig. 69,2) and turn a quarter turn.
 - Remove the key.
- Closing:**
- Firmly close the external flap.
 - Insert key into locking cylinder and turn a quarter turn.
 - Remove the key.

7.3.4 Flap for the 230 V connection

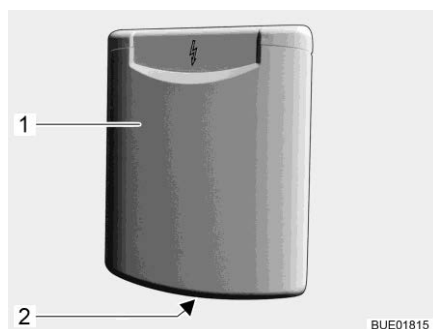

- 1 External flap
- 2 Recessed grip

Fig. 70 Flap for the 230 V connection

- Opening:**
- Reach into the recessed grip (Fig. 70,2) on the external flap (Fig. 70,1) and swing the external flap upward.
- Closing:**
- Swivel the external flap downwards and press it shut.

7.3.5 Cap for the drinking water filler neck

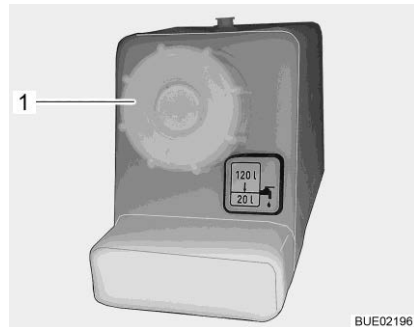

Fig. 71 Cap for the drinking water filler neck

The filler neck is located behind an external flap on the left-hand side of the vehicle. A filling aid (see section 12.2) makes filling water in easier after opening the cap.

7.4 Furniture flaps



- ▷ Before commencing the journey, close all furniture flaps and inner doors and lock them.
- ▷ The furniture flaps shown in this section are examples. Depending on the model, the locks and handles on the furniture flaps may differ to those displayed here.

7.4.1 Furniture flaps with push button



Fig. 72 Furniture flap with push button (square)

- Opening:**
- Press inner part of the lock. The push button jumps out (Fig. 72).
 - Hold push button and open furniture flap.
- Closing:**
- Press furniture flap shut.
 - Press push button in until it locks. The furniture flap is closed correctly when the fastener locks into place.

7.4.2 Furniture flaps with pressurised release

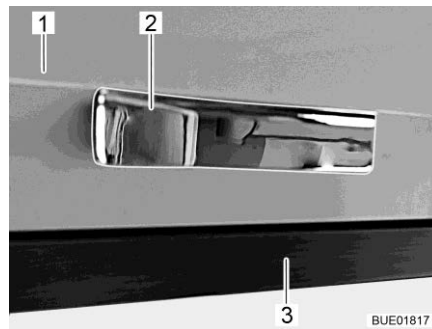

Fig. 73 Furniture flap with pressurised release

- Opening:**
- Press the furniture flap (Fig. 73,1) with the handle (Fig. 73,2) against the cabinet body (Fig. 73,3). The furniture flap is unlocked.
 - Open furniture flap.
- Closing:**
- Press furniture flap shut until the latch audibly engages.

7.4.3 Furniture flaps / drawers with release handle

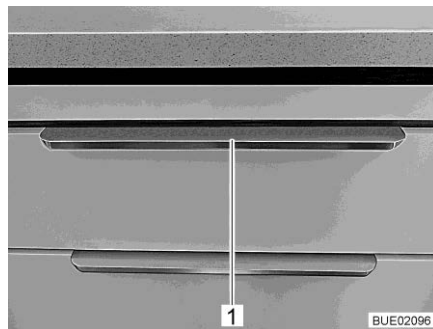

Fig. 74 Release handle

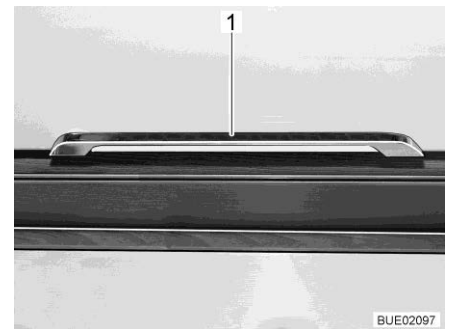

Fig. 75 Release handle (alternative)

- Opening:**
- Press the release handle (Fig. 74,1 or Fig. 75,1) upwards, to the side or downwards depending on the fitted position and hold it down.
 - Pull the release handle until the furniture flap / drawer is open.
- Closing:**
- Close furniture flap / drawer until the lock engages audibly.

7.5 Floor compartment cover

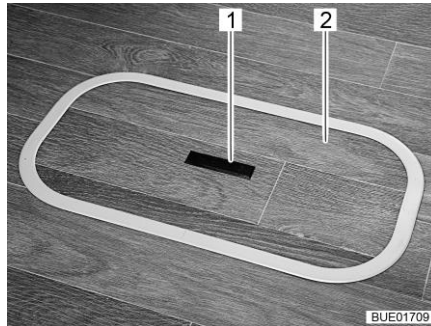

Fig. 76 Floor compartment cover
(handle recessed)

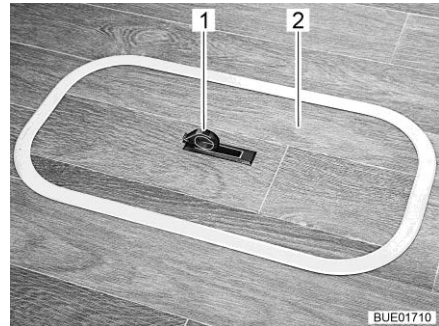

Fig. 77 Floor compartment cover
(handle swung out)

- Opening:**
- Push one side of the grip plate (Fig. 76,1) downwards. The handle (Fig. 77,1) swivels upwards.
 - Remove the cover (Fig. 76,2 or Fig. 77,2) upwards.
- Closing:**
- Insert the cover in the frame on the floor.
 - Swivel handle downwards.

7.6 Light switch

7.6.1 Entrance area



- ▷ The light switches shown in this section are examples. Depending on the model, the type and allocation of the light switches may differ to those displayed here.

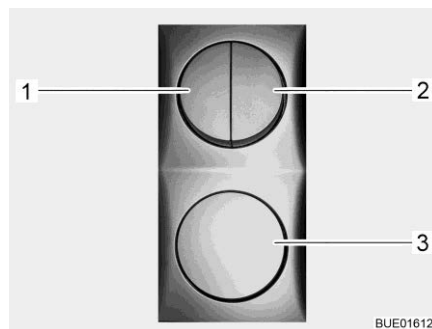

Fig. 78 Light switch

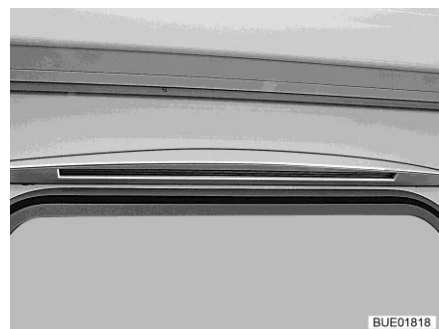

Fig. 79 Awning light

The entrance area has light switches (Fig. 78,1-3) for the following lamps:

- Entrance lighting
- Awning lights (Fig. 79) (partially special equipment)
- Living area lighting
- Canvas blind lighting (special equipment)

7.6.2 Interior



- ▷ The lamps shown in this section are examples. Not all lamps used in the vehicle are shown. The examples are intended to clarify the possible positions for the light switches. The type and appearance of the light switches can deviate from those shown here.

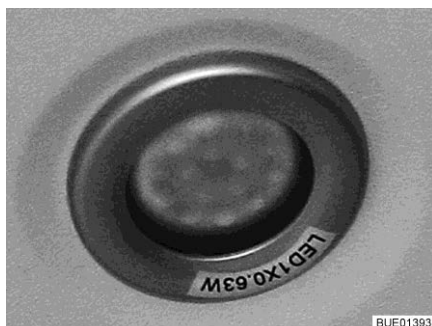

Fig. 80 Recessed light (example)



Fig. 81 Light rail (example)

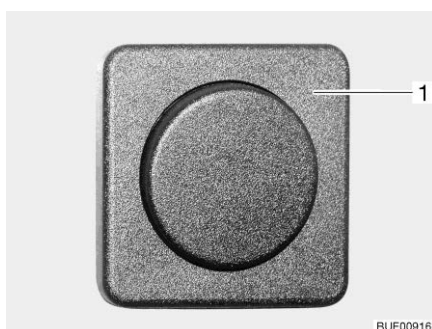

Fig. 82 Separate light switch

Depending on the model, the light switches are fitted at various points: The switch is separated from the light (Fig. 80,1 or Fig. 81,1) at easily accessible locations (Fig. 82,1).

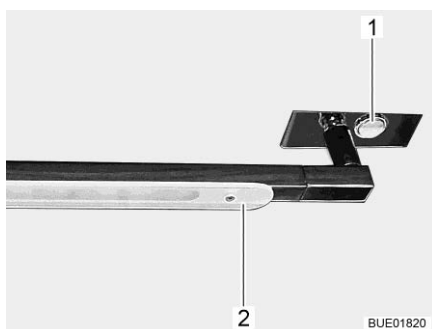

Fig. 83 Tube lamp, swivelling

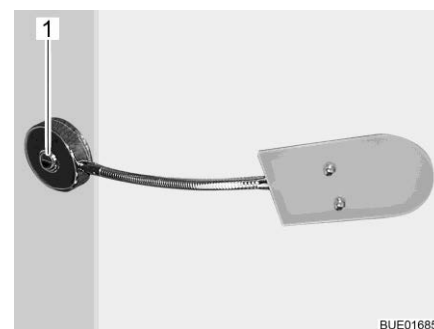

Fig. 84 Spotlight

In the case of tube lamps or spotlights, the light switch (Fig. 83,1 or Fig. 84,1) is generally located on the lamp itself.

The tube lamp (Fig. 83,2) can be swivelled to the side.

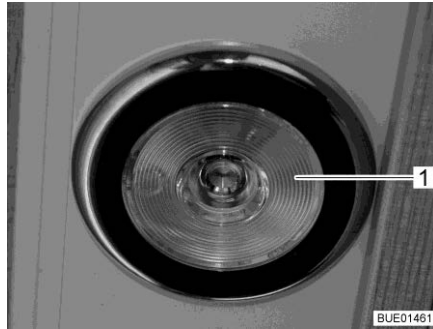

Fig. 85 Recessed light, light switch in the lamp

To switch the recessed light on and off, press the interior of the recessed light (Fig. 85,1).

7.6.3 Wardrobe light



- ▷ The wardrobe light can be removed from its holder (Fig. 86,1) and used as a torch.
- ▷ When the wardrobe door is closed, the wardrobe light switches off automatically.
- ▷ A brightness sensor ensures that the wardrobe light comes on only when it is dark. This prevents the wardrobe light from being accidentally switched on during daylight hours, which would waste the batteries.

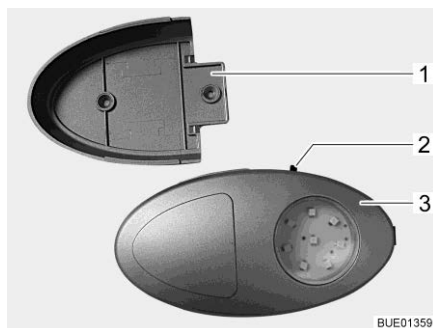

Fig. 86 Wardrobe light/torch

The On/Off switch (Fig. 86,2) is located directly on the wardrobe light (Fig. 86,3).

7.6.4 Tube lamp in the rear garage

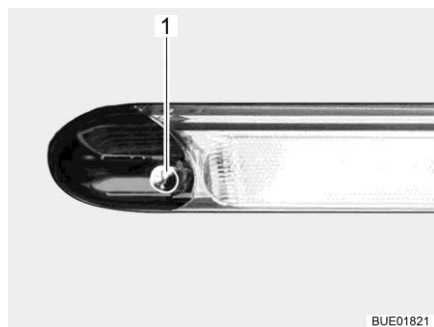

Fig. 87 Tube lamp in the rear garage

Move your hand over the sensor (Fig. 87,1) on the lamp to switch it on and off.

7.7 Light control

Functions

Depending on the model, the vehicle is fitted with a central lighting system. This lighting system operates and dims single lamps or lamp groups that form part of the lighting system.

Furthermore, scene functions are integrated into the lighting system. These scene functions enable the user to save and automatically recall the desired brightness of all lamp groups.



▷ The lights that are not integrated into the lighting system (e.g. kitchen light, bathroom light or reading spotlights) are switched on and off via separate light switches.

Light switch

The lights that are integrated into the lighting system are controlled via buttons on the panel (Fig. 88) or via buttons on two switches (Fig. 89 and Fig. 90). The switches are installed at various points in the vehicle.

Buttons on the panel

All light control functions are available on the panel.



Fig. 88 Panel

Buttons on the switch Not all light control functions are available on the two switches.



Fig. 89 Buttons in the living area

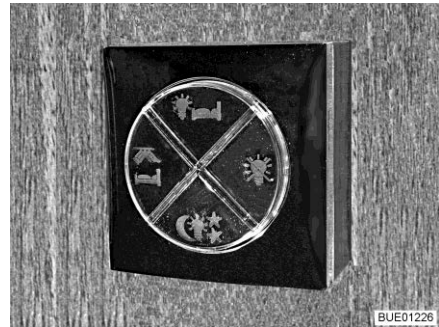







Fig. 90 Buttons in the living or sleeping area

Symbols The symbols listed in the following table always have the same meaning.

Symbol	Signification
M	Light scene
	Main light, living area
	Indirect lighting, living area
	Main light, sleeping area
	Indirect lighting, sleeping area
	Night light
	All lights "OFF"

Operation Each button has different functions:

Button	Press shortly	Keep pressed
Scene	Switch the preset scene on/off	Save the current scene setting (> 3 seconds, until all lamps which are switched on flicker briefly)
Light	Switch the appropriate lamp on/off	Dim the appropriate lamp (> 1 second)

7.8 Holder for flat screen



- ▶ Before commencing the journey, place and secure the flat screen and screen support in the initial position. If the screen holder is installed in a TV cabinet: Close TV cabinet.

7.8.1 Holder on the column

The holder for the flat screen is attached to a column.

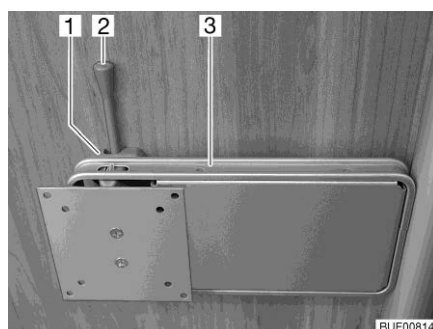

Fig. 91 Holder on the column

- Positioning:**
- Push the release lever (Fig. 91,2) to the side and turn the holder (Fig. 91,3) with the flat screen to the desired position.
 - Press the flat screen slightly upwards and swivel it to the desired position. Three different inclination angles may be used.
- Storing away:**
- Turn the flat screen back until the holder (Fig. 91,3) engages in the lock (Fig. 91,1).

7.8.2 Wall holder

The flat screen is fastened to a wall holder.

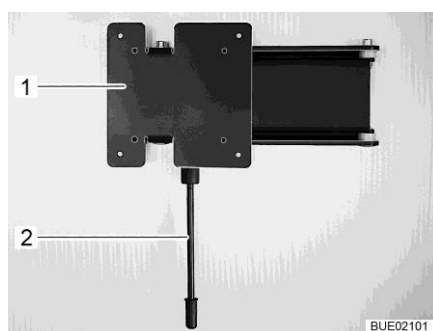

Fig. 92 Wall holder

- Positioning:**
- Pull down the release lever (Fig. 92,1) and turn the holder (Fig. 92,2) with the flat screen to the desired position.
- Storing away:**
- Pull down the release lever and push back the flat screen until the holder engages.

7.8.3 Holder with release lever

The holder for the flat screen is attached to the wall.

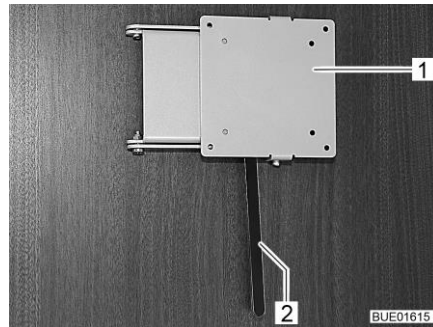

Fig. 93 Holder with release lever

- Positioning:**
- Push the release lever (Fig. 93,2) to the side and turn the holder (Fig. 93,1) with the flat screen to the desired position.
 - Press the flat screen slightly upwards and swivel it to the desired position. Three different inclination angles may be used.
- Storing away:**
- Turn flat screen back until the holder (Fig. 93,1) engages in the lock.

7.9 Ventilation



- ▶ The oxygen in the vehicle interior is used up by breathing and the use of gas operated appliances. That is why the used air must be replaced permanently. For this purpose, forced ventilation options (e.g. skylights with forced ventilation, mushroom-shaped vents or floor vents) are fitted to the vehicle. Never cover or block forced ventilations from the inside or outside with objects such as e.g. a winter mat. Keep forced ventilations clear of snow and leaves. There is a danger of suffocation due to increased CO₂ levels.



- ▷ In the case of the vehicles with rear pull-down bed and skylight, condensation may form in the area of the roof curvature when the rear pull-down bed is located in the top position.
When the vehicle is parked, lower the rear pull-down bed slightly to improve the air circulation.



- ▷ Although sufficient ventilation is provided, in certain weather conditions, condensation can form on metal objects (e.g. screwed connections in the floor).
- ▷ Additional cold spots can occur at thermal "bridges" (e.g. mushroom-shaped vents, skylight edges, sockets, filler necks, flaps, etc.).

Condensation

Ensure that there is a continuous exchange of air by providing frequent and efficient ventilation. This is the only method for ensuring that condensation and resulting mould is not formed during cool weather. During the colder season, a pleasant living climate is created if heating output, air distribution and ventilation are synchronised. To avoid draft close the air outlet nozzles on the dashboard and set the air distribution of the base vehicle to air circulation.

If the vehicle is laid up for a longer period, occasionally ventilate it well, especially in summer as heat accumulation can occur. Do not only air the interior, but also the storage spaces which are accessible from the outside. Air the parking place as well if the vehicle is parked in a closed space (e.g. garage). The occurrence of condensation could lead to the formation of mould.

7.10 Windows

- ▷ The windows are fitted with a blind or Roman shade and with an insect screen or folding insect screen. After the latch has been released, the blind and insect screen automatically spring back to the initial position by tensile force. In order not to damage the tension mechanics, hold onto the blind or insect screen and allow it to slowly return to the initial position. The Roman shade and folding insect screen are made of thin woven fabric. In order not to damage the Roman shade or the insect screen, grasp the respective handle and carefully return it to the initial position.
- ▷ Do not keep blinds closed over a longer period of time as that can cause increased material wear.
- ▷ If the blind or the Roman shade is completely closed, exposure to direct sunlight can cause heat to accumulate between the blind/the Roman shade and the window. The window could be damaged.

Therefore, if the shade is installed in the bottom blind box, close the shade only 2/3 when sunlight is intense. This allows the heat to escape between the window and the shade.

If the shade is installed in the top blind box, close the shade fully and open it regularly.

Also move the window into the "continuous ventilation" position.

- ▷ Before commencing the journey, close the windows.
- ▷ Depending on the weather, close the windows far enough to prevent moisture from entering.
- ▷ To open and close the window, open or close all catch levers which are fitted to the window.



- ▷ When leaving the vehicle, always close the windows.
- ▷ In extreme weather conditions or if the temperature fluctuates strongly, a light condensation film can form on the double-glazed acrylic glass. The glass is designed in such a way that condensation can evaporate when the external temperature increases. There is no danger of the double-glazed acrylic glass being damaged by condensation.

7.10.1 Hinged window



- ▷ If windows with automatic hinges are fitted, open the window fully in order to release the lock. If the locking device is not released and the window is closed nevertheless, there is the danger of the window breaking due to the massive counter-pressure.
- ▷ When opening the hinged windows, ensure that there are no torsional forces. Open and close the hinged windows evenly.
- ▷ If the catch lever is equipped with a safety knob, press the safety knob when operating the catch lever.

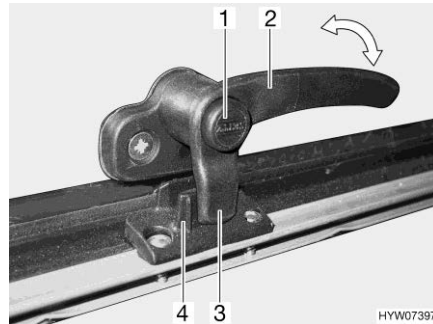

Fig. 94 Catch lever with safety knob in "closed" position

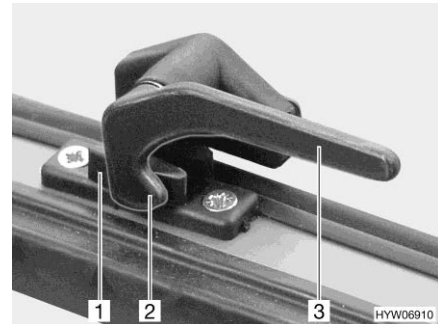

Fig. 95 Catch lever in "closed" position

- Opening:**
- Press and hold the security button (Fig. 94,1), if present.
 - Turn the catch lever (Fig. 94,2 or Fig. 95,3) a quarter turn towards the centre of the window.

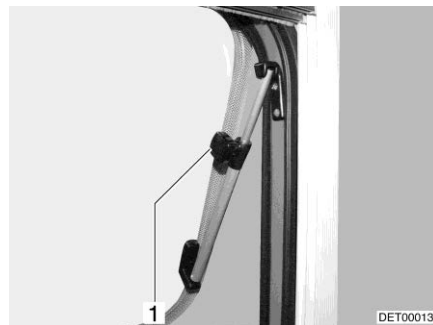

Fig. 96 Hinged window with rotary hinge



Fig. 97 Hinged window with automatic hinge

- Hinged window with rotary hinge: Open the hinged window until the required position has been reached and use knurled knob (Fig. 96,1) to secure in position.

Hinged window with automatic hinge: Open the hinged window to the desired latched position. The automatic hinge (Fig. 97,1) locks in place automatically.

The hinged window remains locked in the required position.

- Closing:**
- Hinged window with rotary hinge: Turn knurled knob (Fig. 96,1) until the latch is released.
Hinged window with automatic hinge: Open the hinged window as wide as is necessary to release the lock.
 - Close the hinged window.
 - Press and hold the security button (Fig. 94,1), if present.
 - Turn the catch lever (Fig. 94,2 or Fig. 95,3) a quarter turn towards the window frame.
The locking catch (Fig. 94,3 or Fig. 95,2) on the catch lever is entirely on the inner side of the window catch (Fig. 94,4 or Fig. 95,1).

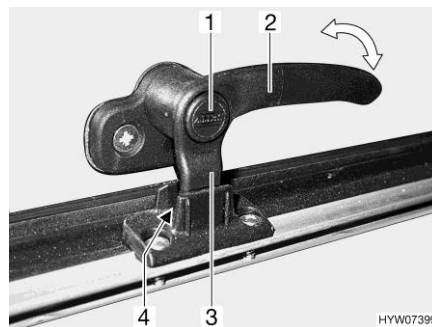

Fig. 98 Catch lever with safety knob in "continuous ventilation" position

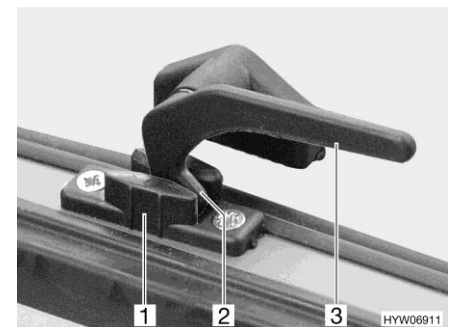

Fig. 99 Catch lever in "continuous ventilation" position

Continuous ventilation

With the catch lever, the hinged window can be placed in two positions:

- "Continuous ventilation" (Fig. 98 and Fig. 99)
- "Firmly closed" (Fig. 94 and Fig. 95)

To place the hinged window into the "continuous ventilation" position:

- Press and hold the security button (Fig. 98,1), if present.
- Turn the catch lever (Fig. 98,2 or Fig. 99,3) a quarter turn towards the centre of the window.
- Slightly open the hinged window outwards.
- Return the catch lever to its initial position. Move the locking catch (Fig. 98,3 or Fig. 99,2) on the catch lever into the recess of the window catch (Fig. 98,4 or Fig. 99,1).
- Press and hold the security button (Fig. 98,1), if present.
- Make certain that the safety knob is not pushed in but rather that it secures the catch lever.

During the journey, the hinged window may not be in "continuous ventilation" position.

If it rains, the "continuous ventilation" hinged window position could lead to splashing water penetrating the living area. Therefore, close the hinged windows completely.

7.10.2 Sliding window with pressure lock

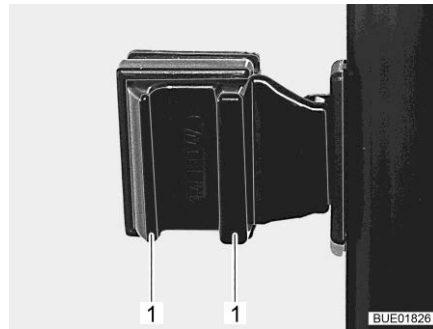

Fig. 100 Sliding window with pressure lock

- Opening:**
- Press the handles (Fig. 100,1) together and hold them in place.
 - Open window half up to the required position.
- Closing:**
- Press the handles together and hold them in place.
 - Close the window as far as it can go.

7.10.3 Roman shade and insect screen

The windows are fitted with a Roman shade and an insect screen. The insect screen can only be moved together with the Roman shade.

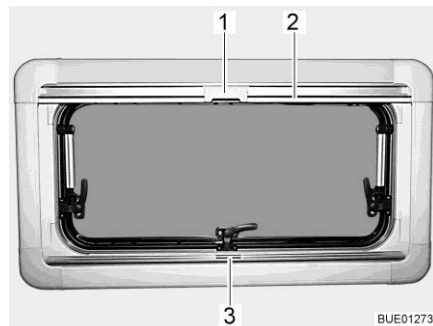

Fig. 101 Hinged window

Roman shade The Roman shade is located in the bottom blind box.

- Closing:**
- Grip the Roman shade in the centre of the holding bar (Fig. 101,3), pull it from the bottom to the top and then release it at the desired height. The Roman shade will stay at this height.
- Opening:**
- Grip the Roman shade in the centre of the holding bar and push it down.

Insect screen The insect screen is located in the upper blind box.

- Closing:**
- Pull the insect screen down using the holding bar (Fig. 101,2), until it touches the holding bar of the Roman shade (Fig. 101,3).
 - Clip the catch (Fig. 101,1) on the insect screen into the handle of the Roman shade.

- Opening:**
- Push the catch (Fig. 101,1) on the insect screen inwards.
 - Move the insect screen back slowly on the holding bar (Fig. 101,2).

7.10.4 Roman shades for windscreen, driver's window and front passenger's window

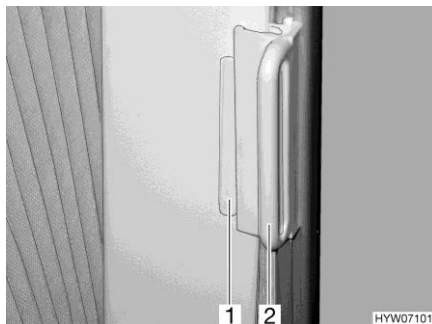

Fig. 102 Roman shade, driver's cabin window

- Closing:**
- Grasp the handle (Fig. 102,2) of the Roman shades and draw carefully until the magnetic catch keeps the Roman shades closed.
- Opening:**
- Using the handle, carefully push back the Roman shades.
 - Push the handle (Fig. 102,2) onto the cap (Fig. 102,1). The Roman shade is secured.

7.10.5 Manual windscreen shade

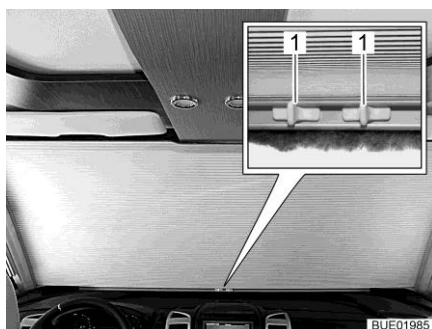

Fig. 103 Manual windscreen shade, closed

- Closing:**
- Clench handles (Fig. 103,1).
 - Pull the windscreen shade downwards to the desired height.
- Opening:**
- Clench the handles.
 - Push the windscreen shade upwards until it engages.

7.10.6 Electrical windscreen shade



- ▶ Before starting the journey, roll the windscreen shade (from below) fully downwards, so that the driver's field of view is not obstructed.



- ▷ So that visibility is guaranteed at all times while driving, secure the windscreen shade with two securing latches before setting off.

A switch panel with the switches for the windscreen shade is installed next to the driver's seat, in front of the driver's door.

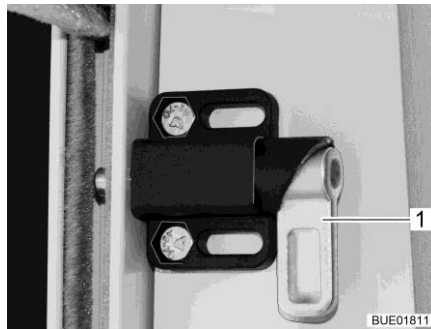

Fig. 104 Securing latch, windscreen shade

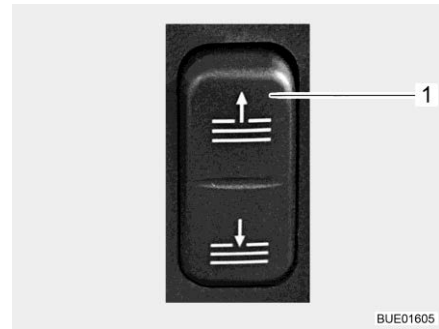

Fig. 105 Switch for windscreen shade

- Closing:**
- Turn the securing latch (Fig. 104,1) upwards on both sides.
 - Push down and hold the switch (Fig. 105,1) until the windscreen shade has reached the required position.
 - Release the switch. The windscreen shade will stay in that position.
- Opening:**
- Push up the switch (Fig. 105,1) and keep it pressed until the windscreen shade has moved up completely.
 - Release the switch.
 - Turn the securing latch (Fig. 104,1) downwards on both sides.

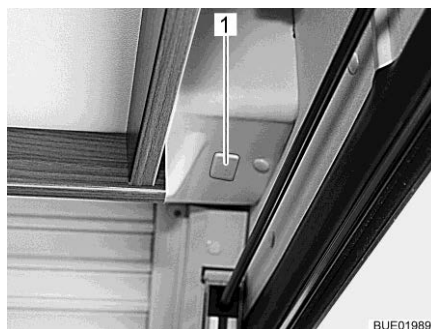

Fig. 106 Access to emergency operation

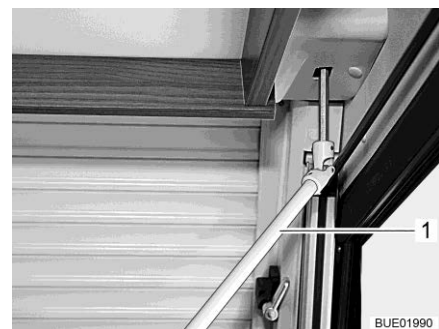

Fig. 107 Hand crank for emergency operation

Emergency operation

If the windscreen shade can no longer be moved using the switch (for example, due to a loss of the vehicle's power supply), the windscreen shade can be operated manually. To do this, proceed as follows:

- Remove cover (Fig. 106,1) from the holder for the hand crank.
- Insert the included hand crank (Fig. 107,1) into the holder.
- Open or close the windscreen shade manually with the hand crank.
- Remove hand crank and store it.
- Close the holder for the hand crank with the cover (Fig. 106,1).

If the vehicle's power supply fails when the pull-down bed is in the raised position and the windscreen shade is in the lowest position, the panel of the pull-down bed will obscure the hand crank. If this happens, the panel must be removed.

7.11 Skylights

Depending on the model, skylights with or without forced ventilation are fitted to the vehicle. If a skylight is fitted without forced ventilation, the forced ventilation is performed using mushroom-shaped vents.



- ▶ The apertures for forced ventilation must always be kept open. Never cover or block forced ventilations with objects such as e.g. a winter mat. Keep forced ventilations clear of snow and leaves.



- ▷ The skylights are fitted with a blind or Roman shade and with an insect screen or folding insect screen. After the latch has been released, the blind and insect screen automatically spring back to the initial position by tensile force. In order not to damage the tension mechanics, hold onto the blind or insect screen and allow it to slowly return to the initial position. The Roman shade and folding insect screen are made of thin woven fabric. In order not to damage the Roman shade or the insect screen, grasp the respective handle and carefully return it to the initial position.
- ▷ Do not keep blinds closed over a longer period of time as that can cause increased material wear.
- ▷ If the blind or the Roman shade is completely closed, exposure to direct sunlight can cause heat to accumulate between the blind/the Roman shade and the skylight. The skylight could be damaged. For that reason, close the blind/Roman shade only 2/3 of the way in direct sunlight. Open the skylight slightly or move it to ventilation position.
- ▷ Depending on the weather, close the skylights far enough to prevent moisture from entering.
- ▷ Do not climb on the skylights.
- ▷ Before commencing the journey, close the skylights.
- ▷ Before commencing the journey, check that the skylights are closed and locked.



- ▷ When leaving the vehicle, always close the skylights.

7.11.1 Heki skylight

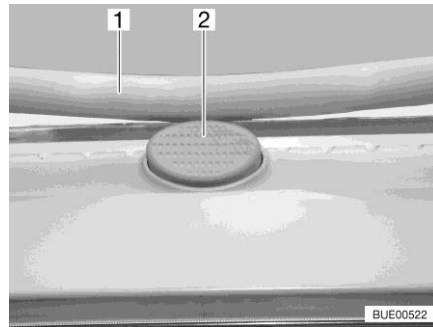

Fig. 108 Safety knob (Heki skylight)

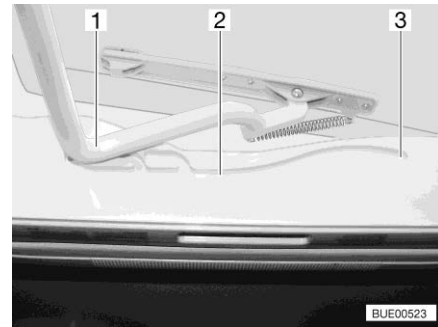

Fig. 109 Guide (Heki skylight)

The Heki skylight is opened on one side only.

- Opening:**
- Press the safety knob (Fig. 108,2) and pull the bar (Fig. 108,1) down with both hands.
 - Pull the bar (Fig. 109,1) in the guides (Fig. 109,2) to the rearmost position (Fig. 109,3).
- Closing:**
- Use both hands to push the bar (Fig. 109,1) slightly upwards.
 - Push the bar back in the guides.
 - Push the bar upwards with both hands until it is above the safety knob (Fig. 108,2).

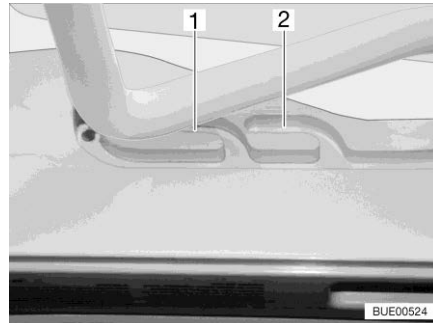

Fig. 110 Guide (ventilation position)

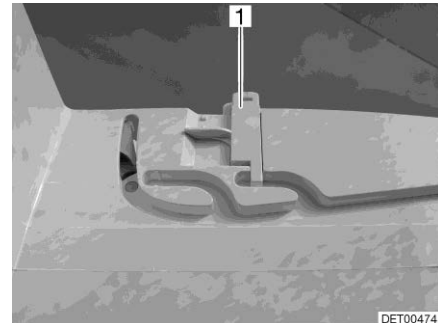

Fig. 111 Lock (ventilation position)

Ventilation position

The Heki skylight can be put in two ventilation positions: Bad weather position (Fig. 110,1) and central position (Fig. 110,2). Depending on the model, the skylight can be locked in the central position with both left and right latches (Fig. 111,1) on the skylight frame.

- Press the safety knob (Fig. 108,2) and pull the bar (Fig. 108,1) down with both hands.
- Pull the bar in the guides (Fig. 109,2) to the desired position.
- Push the bar slightly upwards and into the selected guide (Fig. 110,1 or 2) and lock if necessary.

- Roman shade** To close and open the Roman shade:
- Closing:** ■ Pull out Roman shade at the handle and release in the required position. The Roman shade will stay in that position.
- Opening:** ■ Slowly push the Roman shade at the handle to its initial position.
- Insect screen** To close and open the insect screen:
- Closing:** ■ Pull the insect screen by the handle to the opposite handle of the Roman shade.
- Opening:** ■ Press the rear part of the handle of the insect screen. The latch is released.
- Use handle to return the insect screen slowly to its initial position.

7.11.2 Skylight with snap latch



Fig. 112 Skylight with snap latch

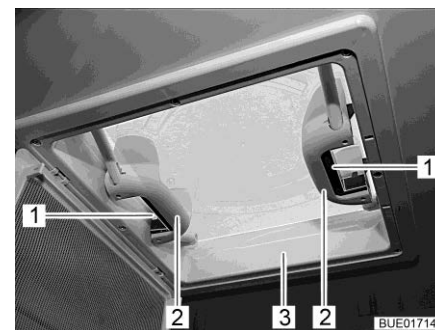

Fig. 113 Handles with snap latches

The skylight can be pushed upwards either from one side or from both sides.

- Opening:** ■ Use handle (Fig. 112,1) to swing down the insect screen (Fig. 112,2).
- Push the snap latch (Fig. 113,1) towards the inside of the skylight (Fig. 113,3). At the same time use the handle (Fig. 113,2) to press the skylight upwards.
- Swing insect screen upwards until it latches in place.
- Closing:** ■ Use handle (Fig. 112,1) to swing down the insect screen (Fig. 112,2).
- Using both handles (Fig. 113,2), pull down the skylight (Fig. 113,3) with force until the two snap latches (Fig. 113,1) lock into place.
- Swing insect screen upwards until it latches in place.

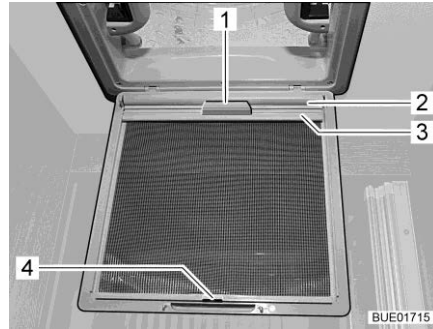

Fig. 114 Blind (skylight)

Blind Depending on the equipment, there will be a blind installed.

- Closing:**
- Use handle (Fig. 112,1) to swing down the insect screen (Fig. 112,2).
 - Using the handle (Fig. 114,1), pull out the blind (Fig. 114,2) and hook the retainer (Fig. 114,3) into the hook (Fig. 114,4) on the insect screen.
 - Swing insect screen upwards until it latches in place.
- Opening:**
- Use handle (Fig. 112,1) to swing down the insect screen (Fig. 112,2).
 - Release the retainer (Fig. 114,3) from the hook (Fig. 114,4) and, using the handle (Fig. 114,1), slowly return the blind (Fig. 114,2).
 - Swing insect screen upwards until it latches in place.

7.11.3 Skylight with fan (special equipment)



- ▷ To save the battery, after one hour the fan automatically switches from level 6 down to level 1.

The skylight is equipped with an insect screen, blind and an adjustable fan for aerating and venting.

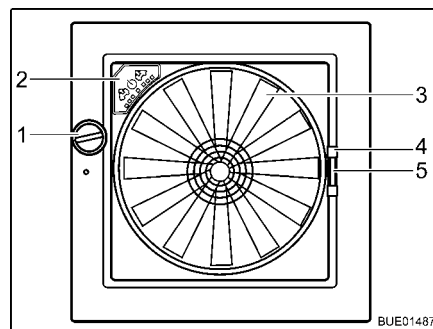

Fig. 115 Omni-Vent skylight

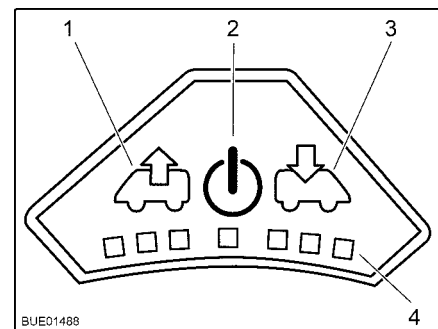

Fig. 116 Control panel for fan

- Opening:**
- Turn the knob (Fig. 115,1) until the desired opening angle is reached.
- Closing:**
- Turn the knob (Fig. 115,1) until the skylight is fully closed.

- Insect screen** To close and open the insect screen:
- Closing:**
- Using the handle (Fig. 115,4) pull the insect screen across to the other side of the frame.
- Opening:**
- Press the handle of the insect screen together. The latch is released.
 - Use handle to return the insect screen slowly to its initial position.
- Shade** To close and open the shade:
- Closing:**
- Press together the handle (Fig. 115,5) of the shade.
 - Pull out the shade to the desired position and release. The shade will stay in that position.
- Opening:**
- Press together the handle of the shade.
 - Slowly return the shade to its initial position.
- Fan** If the skylight is open, the interior can be vented and aerated with the 6-speed fan (Fig. 115,3). The fan is operated via the operating panel (Fig. 115,2).
- Switching on:**
- Press the On/Off button (Fig. 116,2). The fan runs in comfort mode (venting at slowest fan speed).
- Venting:**
- To increase the fan speed: Press the Vent button (Fig. 116,1). The fan speed in the venting direction increases by one level. LEDs (Fig. 116,4) show the operating levels.
 - To lower the fan speed: Press the Aerate button (Fig. 116,3). The fan speed decreases by one level.
- Aerating:**
- To increase the fan speed: Press the Aerate button (Fig. 116,3). The fan speed in the aerating direction increases by one step. LEDs (Fig. 116,4) show the operating levels.
 - To lower the fan speed: Press the Vent button (Fig. 116,1). The fan speed decreases by one level.
- Boost function:**
- Press and hold the Aerate button for approx. 3 seconds. The fan switches to the maximum aeration level and then, after approximately 5 minutes, automatically switches back to the previously selected level.
 - Press and hold the Vent button for approx. 3 seconds. The fan switches to the maximum venting level and then, after approximately 5 minutes, automatically switches back to the previously selected level.
- Switching off:**
- Press the On/Off button (Fig. 116,2). The fan stops, the LEDs go out.

7.12 Tables

Depending on the model and equipment, various types of tables may be installed. The tables' features differ in the following ways:

	Table leg	Table top	Conversion to bed foundation
Fixed table	Screwed to the floor	Shiftable, rotatable, partially enlargeable	Not possible
Suspension table	Single section	Extendible	Not possible



▷ Depending on the model, the tables can be adjusted in one or more of the aforementioned ways.

The tables' main operation is described below. The type and position of the operating controls may vary slightly.

7.12.1 Fixed table

Table leg The table leg is screwed into the floor.

Table top The table top can be shifted and enlarged.



Fig. 117 Unlocking of the table top

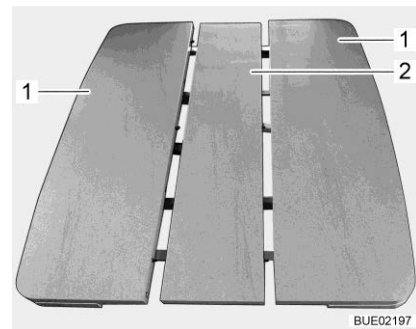

Fig. 118 Table top with centre extension

- Shifting the table top:**
- Fold lever (Fig. 117,1) downward.
 - Push the table top to the desired position.
 - Fold the lever back upwards.

- Enlarging the table top:**
- Hold table top (Fig. 118,1) on both long sides and pull apart (you need a second person to do this). The centre extension (Fig. 118,2) underneath the table top slides upwards automatically by force of springs.
 - Press table top carefully together on both sides (keep an eye on plastic pins and holes) until a continuous table top is created.

- Reducing the table top size:**
- Hold table top (Fig. 118,1) on both long sides and pull apart (you need a second person to do this).
 - Press centre extension (Fig. 118,2) downwards against the force of the springs and hold it there.
 - Press table top carefully together on both sides (keep an eye on plastic pins and holes) until a continuous table top is created

7.13 Beds



- ▶ Always use the safety guards supplied.
- ▶ Never remove or dismantle the safety guards supplied.
- ▶ If access aids (e.g. foldable steps) are provided, always use these access aids when climbing into and out of the bed.

7.13.1 Pull-down bed, manually operated



- ▶ Switch off the reading lamps in the pull-down bed before the bed is pushed up. Fire hazard!
- ▶ Switch off the reading lamps on the underside of the pull-down bed when the bed is lowered. Fire hazard!
- ▶ The maximum permitted pull-down bed load is 200 kg.
- ▶ Before commencing the journey, secure the pull-down bed. To do this, lock the pull-down bed.
- ▶ Before use, pull the pull-down bed into the lower end position. Ensure that the pull-down bed is not resting on obstacles such as headrests, cushions or similar.
- ▶ If there is a safety net: Only use the pull-down bed, if the safety net is set up.
- ▶ Never allow small children to remain in the pull-down bed without supervision.
- ▶ But in particular with regard to small children less than 6 years of age, users should ensure that they cannot fall out of the pull-down bed.
- ▶ Use separate children's beds or travel cots suitable for children.



- ▷ You must be able to close the pull-down bed without any great effort, so that there is no tension in the locking position. Objects on the pull-down bed can distort the lifting mechanism on one side, resulting in damage.

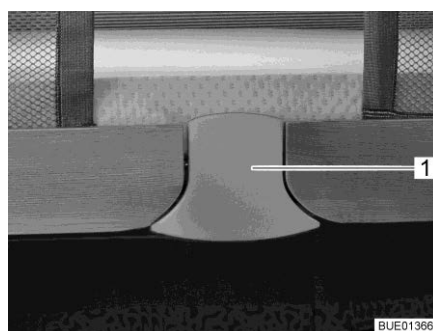

Fig. 119 Release

The pull-down bed is located in the driver's cabin above the seats.

Lowering the pull-down bed:

- Switch off the lamps underneath the pull-down bed.
- Rotate the driver's and front passenger's seats in the direction of travel, lock in position, push backwards as far as possible and fold the backrest as far to the front as possible.
- Close the shade in the driver's cabin.
- Pull out the release plate (Fig. 119,1) at the bottom. The lock is released.
- Use both hands to pull the pull-down bed down as far as it will go.
- Make sure that the pull-down bed is in the lower end position and is not resting on obstacles such as headrests, cushions or similar.



- ▷ When closing the pull-down bed, pull the side fabric panels inwards. This prevents the fabric from getting trapped in the lock of the pull-down bed.

Lifting the pull-down bed:

- Switch off the lamps in the pull-down bed.
- Use both hands to push pull-down bed upwards as far as it will go. When doing this, ensure that the snap lock engages audibly in the locking bracket.
- Check that the pull-down bed is locked correctly. To do this, pull down the pull-down bed firmly.

Pull-down bed guide

If the pull-down bed has clearance in the sleeping position, the pull-down bed guide can be adjusted.

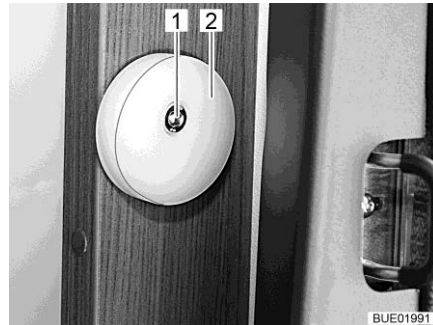

Fig. 120 Pull-down bed guide

Adjusting the pull-down bed guide:

- Release the screw (Fig. 120,1).
- Adjust the guide disc (Fig. 120,2).
- Tighten the screw (Fig. 120,1).

Safety net If fitted, the safety net (Fig. 121,2) and the retaining belts are located beneath the mattress of the pull-down bed. Only use the safety net if persons are already in the pull-down bed.

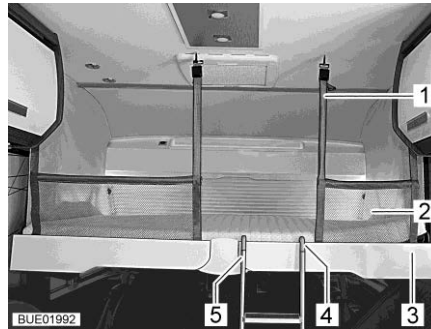

Fig. 121 Pull-down bed complete with applied safety net

Setting up: ■ Attach retaining belts (Fig. 121,1) to the hooks on the ceiling.

Access ladder Always use the provided access ladder to climb up to the pull-down bed.



▷ The access ladder will differ according to the model.

Attaching the foldable step ladder:

- Hook step ladder (Fig. 121,5) to the pull-down bed by attaching the two hooks (Fig. 121,4) in the holding bar (Fig. 121,3).
- Grasp the upper edge of the folded-up part of the step ladder and unfold it so that all four feet are securely on the ground.



▷ Fold up the steps before removing the step ladder.

7.13.2 Pull-down bed, electrically operated (partially special equipment)



- ▶ Switch off the reading lamps in the pull-down bed before the bed is pushed up. Fire hazard!
- ▶ Switch off the reading lamps on the underside of the pull-down bed when the bed is lowered. Fire hazard!
- ▶ The maximum permitted pull-down bed load is 200 kg.
- ▶ Do not allow children to play with the pull-down bed.
- ▶ Store the remote control in a safe place inaccessible to children.
- ▶ Never allow small children to remain in the pull-down bed without supervision.
- ▶ But in particular with regard to small children less than 6 years of age, users should ensure that they cannot fall out of the pull-down bed.
- ▶ Use separate children's beds or travel cots suitable for children.



- ▶ If there is a safety net: Only use the pull-down bed, if the safety net is set up.
- ▶ Do not reach into the area between the bed and the side wall when lowering or raising. Danger of bruises!
- ▶ Do not lower or lift the bed when there are people using the pull-down bed.
- ▶ Only lower the bed if the lowering area is clear.
- ▶ Bring the pull-down bed into the lower end position before use. Ensure that the pull-down bed is not resting on obstacles such as headrests, cushions or similar.



- ▷ Only raise or lower the pull-down bed if it is loaded with a maximum of 15 kg. This maximum load includes the contents of the wall-mounted cupboard at the base of the pull-down bed. If the pull-down bed is overloaded, the overload protection switches off the lifting motor. However, the lifting mechanism can still be damaged.
- ▷ Remove all objects (even bed linen) from the pull-down bed before commencing the journey.
- ▷ Before commencing the journey, move the pull-down bed into the top end position.
- ▷ In the case of the vehicles with rear pull-down bed and skylight, condensation may form in the area of the roof curvature when the rear pull-down bed is located in the top position.
When the vehicle is parked, lower the rear pull-down bed slightly to improve the air circulation.



- ▷ In order to ensure that the pull-down bed functions correctly, the living room temperature must be at least 5 °C.

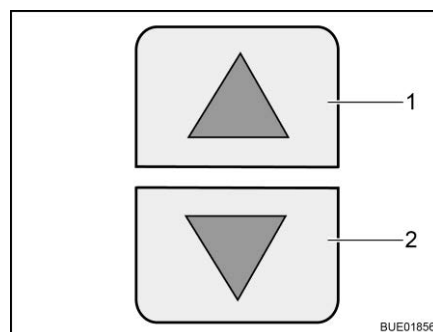

Fig. 122 Arrow keys on the control unit



Fig. 123 Pull-down bed complete with applied safety net

The control unit for the pull-down bed is located directly on the pull-down bed.



- ▶ When making ready for operation, overload protection is not in use.

Making ready for operation

After every power interruption (e.g. lay-up over winter), the electrical drive must be made ready for operation again. To do so carry out a reference run.



- ▷ If the pull-down bed is at an angle during the reference run: Immediately end the reference run. Proceed as described under "Emergency operation" (see below).

Carrying out a reference run/reset:

- Press the arrow keys (Fig. 122,1 and 2) on the control unit simultaneously and keep them pressed until the pull-down bed has moved all the way down.
- When a beeping tone sounds (bottom end position has been reached): Release the arrow keys. The pull-down bed is ready for use again.

Lowering the pull-down bed:

- Switch off the lamps underneath the pull-down bed.
- Press the arrow key (Fig. 122,2) on the control unit and keep it pressed until the pull-down bed has moved down into the end position.
- Make sure that the pull-down bed is in the lower end position and is not resting on obstacles such as headrests, cushions or similar.



- ▷ When closing the pull-down bed, pull the side fabric panels inwards. This prevents the fabric from getting trapped in the lock of the pull-down bed.

Lifting the pull-down bed:

- Switch off the reading lamps on the ceiling.
- Press the arrow key (Fig. 122,1) on the control unit and keep it pressed until the pull-down bed has moved up into the end position.
- Ensure that there are no objects stuck between the roof and the pull-down bed.

Overload protection

If the pull-down bed meets an obstacle during opening or closing (e.g. a person or a headrest), the overload protection stops the movement. For release, move the pull-down bed with the arrow key in the opposite direction.

Safety net

If fitted, the safety net (Fig. 123,2) and the retaining belts are located beneath the mattress of the pull-down bed. Only use the safety net if persons are already in the pull-down bed.

Setting up:

- Attach the retaining belts (Fig. 123,1) to the hooks on the ceiling.

Access ladder

Always use the provided access ladder to climb up to the pull-down bed.

Attaching:

- Hook access ladder (Fig. 123,5) to the pull-down bed by attaching the two hooks (Fig. 123,4) in the holding bar (Fig. 123,3).
- Grasp the upper edge of the folded-up part of the access ladder and unfold it so that all four feet are securely on the ground.

Storing away:

- Fold in steps.
- Hang the access ladder from the holding bar on the pull-down bed.
- Store the access ladder securely.

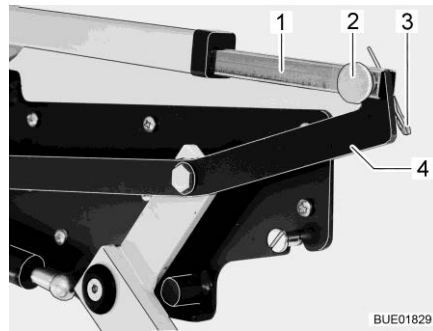

Fig. 124 Drive for the pull-down bed

Emergency operation

If it is not possible to move the pull-down bed via the arrow keys (Fig. 122), check the fuse Circuit 5 on the EBL 220 (see section 9.10.1). If the pull-down bed cannot be moved despite an intact fuse, the pull-down bed must be operated manually. To do this, proceed as follows:

- Remove the pull-down bed mattress and reduce loading the storage cupboards as much as possible (to avoid the pull-down bed from swinging back and forth).
- Release the connection between the push rod (Fig. 124,1) and lever (Fig. 124,4). To do this, pull out the splint (Fig. 124,3) and pin (Fig. 124,2).
- Move the pull-down bed manually into the upper park position and temporarily secure it.
- Contact customer service.

7.13.3

Fixed bed, hydraulic height-adjustable (special equipment)



- ▶ Lower the bed to its lowest position to sleep in it.



- ▷ If the head section has been raised: do not put the entire body weight on the head section (e.g. do not kneel on it). Do not put the weight of heavy objects onto the head section.
- ▷ Lower the head section before setting off.

The height of the fixed bed can be adjusted via a crank in the rear garage.

The bed can be raised before setting off. This increases the storage space under the bed.

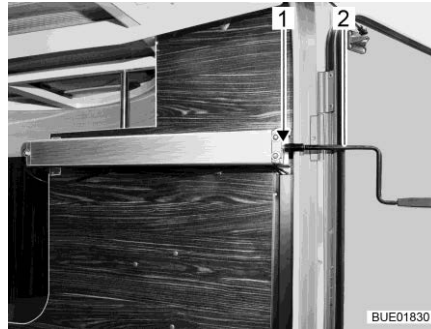

Fig. 125 Crank in the rear garage

- Attach the crank (Fig. 125,2) onto the journal (Fig. 125,1).
- To lift the bed: Turn the crank clockwise.
To lower the bed: Turn the crank anticlockwise.
- Remove the crank and store it.

7.13.4 Lying surface of single beds (special equipment)

The two single beds in the rear can be converted into a combined lying surface.

The additional cushions are stored in a cabinet underneath the bed.

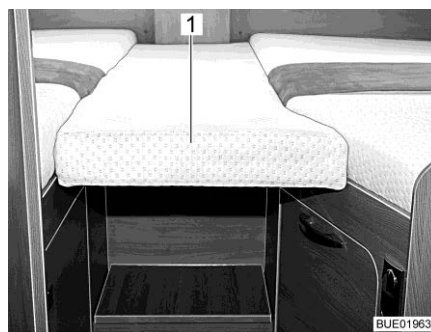

Fig. 126 Additional cushion

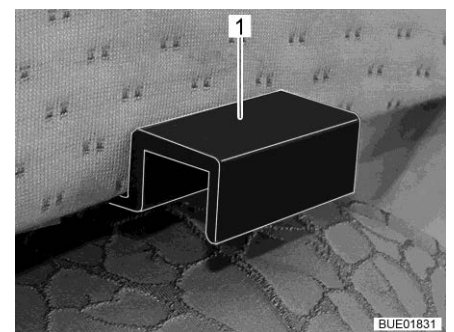

Fig. 127 Additional cushion holder

- Take the additional cushion out of the cabinet.
- Hook the additional cushion (Fig. 126,1) with the holders (Fig. 127,1) into the panels of the single beds so that a closed lying surface is created.

7.14 Shower connection point for external shower (special equipment)



- ▶ Only use the external shower if there is a gap of at least 1.20 m between the shower and the nearest electrical device or connection. Risk of electric shock!



- ▷ If decommissioned for a longer time or if there is a risk of frost, drain the water system.

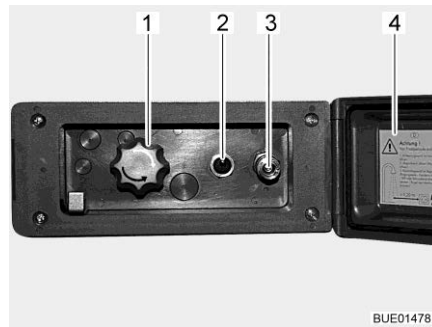

Fig. 128 External shower connection point

Connecting an external shower:

- Unlock and open the cover (Fig. 128,4).
- Attach hose of the external shower to the quick closure (Fig. 128,3).

Using the shower:

- Switch on the water pump using the switch (Fig. 128,2).
- Adjust the water temperature with the rotary knob (Fig. 128,1) as desired.
- Switch off the water pump using the switch (Fig. 128,2).

Shutting off the shower connection point:

- Switch off the water pump using the switch (Fig. 128,2).
- Disconnect the hose from the quick closure. The quick closure is equipped with a check valve to prevent any further water from escaping.
- Close the cover (Fig. 128,4) and lock with key.

Emptying:

- Attach hose of external shower to quick closure. The check valve is opened and the connections can run dry.
- Turn knob (Fig. 128,1) to the central position.
- Empty the water system (see section 11.2.7).

Chapter overview

This chapter contains instructions regarding the gas system of the vehicle. The operation of the gas operation appliances of the vehicle is described in chapter 10.

8.1 General



- ▶ The operator of the gas system is responsible for the performance of recurring inspections and for complying with the maintenance intervals.
- ▶ Before commencing the journey, when leaving the vehicle or when gas equipment is not in use, close all gas isolator taps and the main regulator tap on the gas bottle.
- ▶ All gas-operated devices (heater, cooker, oven, grill, refrigerator - depending on the equipment) must be switched off for refuelling, on ferries or in the garage. Danger of explosion!
- ▶ Do not use gas-operated devices in closed spaces (e.g. garages). Danger of poisoning and suffocation!
- ▶ Only have the gas system maintained, repaired or altered by an authorised specialist workshop.
- ▶ Have the gas system checked by an authorised specialist workshop according to the national regulations before commissioning. This also applies for not registered vehicles. For modifications to the gas system have the gas system immediately checked by an authorised specialist workshop.
- ▶ The gas pressure regulator, the gas tubes, and the exhaust gas pipes must also be inspected. The gas pressure regulator and the gas tubes must be replaced observing the nationally defined deadlines (the latest after 10 years). The vehicle owner is responsible for seeing that this is carried out.
- ▶ In case of a defect of the gas system (gas odour, high gas consumption) there is danger of explosion! Close regulator tap on the gas bottle immediately. Open doors and windows and ventilate well.
- ▶ If the gas system is defective: Do not smoke; do not ignite any open flames, and do not operate electric switches (light switches etc.). Check the tightness of gas-conducting parts and lines with leakage search spray. Do not check with an open flame.
- ▶ Only the stipulated devices may be connected to internal connections. Do not operate any device outside the vehicle if it is connected to an internal connector.
- ▶ Before using the cooker make sure that there is sufficient ventilation. Open a window or the skylight.
- ▶ Cooking is prohibited during the journey.
- ▶ Do not use gas-operated cooking and baking facilities for heating purposes.
- ▶ If there are several gas devices, each gas device must have its own gas isolator tap. If individual gas devices are not in use, close the respective gas isolator tap.



- ▶ Ignition safety valves must close within 1 minute after the gas flame has extinguished. A clicking sound is audible. Check function from time to time.
- ▶ The built-in gas devices are exclusively meant for use with propane or butane gas or a mixture of both. The gas pressure regulator as well as all built-in gas devices are designed for a gas pressure of 30 mbar.
- ▶ Propane gas is capable of gasification up to -42 °C, whereas butane gas gasifies at 0 °C. Below these temperatures no gas pressure is available. Butane gas is unsuitable for use in winter.
- ▶ Due to its function and construction, the gas bottle compartment is a space which is open to the exterior. Never cover or block up the standard forced ventilations. Otherwise gas that is emitted can not be diverted to the outside.
- ▶ The gas bottle compartment must not be used as storage space.
- ▶ Secure the gas bottle compartment against unauthorised access. To do this, lock the compartment.
- ▶ The regulator tap on the gas bottle must be accessible.
- ▶ Only connect gas-operated devices which have been designed for a gas pressure of 30 mbar.
- ▶ The exhaust gas pipe must be fitted tightly to the heating system and to the vent and must be sealed. The exhaust gas pipe must not show any evidence of damage.
- ▶ Exhaust fumes must be able to escape into the atmosphere unhindered and fresh air must be able to enter unhindered. For this reason, keep the exhaust pipe and intake openings clean and unobstructed (e.g. free from snow and ice). For this reason, no snow walls or aprons may lie against the vehicle.

8.2 Gas bottles



- ▶ Handle full or emptied gas bottles outside the vehicle only with closed regulator tap and attached protective cap.
- ▶ Gas bottles are only to be transported within the designated gas bottle compartment.
- ▶ Place the gas bottles in vertical position in the gas bottle compartment.
- ▶ Fasten the gas bottles so that they are unable to turn or tilt.
- ▶ Connect the gas tube to the gas bottle without tension.
- ▶ If the gas bottles are not connected to the gas tube, always place the protective cap on top.
- ▶ Close the regulator tap on the gas bottle before the gas pressure regulator or gas tube are removed from the gas bottle.
- ▶ Depending on the connection, unscrew the gas tube from the gas bottle and screw it on the gas bottle again by hand or using a suitable special spanner. The screw connection on the gas bottle generally has a left-hand thread. **Do not** tighten too firmly.



- ▶ Only use special gas pressure regulators with a safety valve designed for vehicle use. Other gas pressure regulators are not permitted and cannot meet the demanding requirements.
- ▶ Use only 11 kg or 5 kg gas bottles. Camping gas bottles with built-in check valve (blue bottle with max. 2.5 or 3 kg content) are can be used in exceptional cases with a safety valve.
- ▶ Use the shortest possible tube lengths (150 cm max.) for external gas bottles.
- ▶ Never block the floor ventilation openings below the gas bottles.



- ▷ With some models, the gas bottle compartment is located right next to the conversion door. With these models, only open the gas bottle compartment when the conversion door is closed. Danger from damages.



- ▷ The screw connections on the gas bottles generally have a left-hand thread.
- ▷ For gas-operated units the gas pressure must be reduced to 30 mbar.
- ▷ Connect gas pressure regulator complete with safety valve directly to bottle valve.
The gas pressure regulator reduces the gas pressure in the gas bottle down to the operating pressure of the gas devices.
- ▷ For filling and connecting the gas bottles in Europe the accessories shops have corresponding Euro filling sets and Euro bottle sets.
- ▷ Information available at the dealers or service centre.
- ▷ For information on the gas supply in Europe see chapter 18.

The gas pressure regulator is permanently installed in the gas bottle compartment. The gas bottle is connected to the gas pressure regulator via a high-pressure gas hose.

The high-pressure gas hoses and their connections are different in the various countries. The accessories shop offers the respective country-specific models and adapters.

8.3 Gas isolator taps

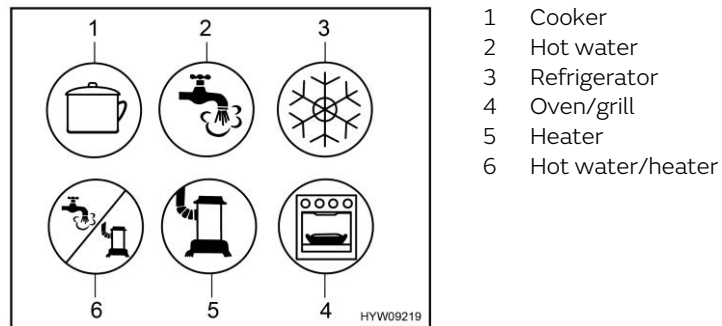

Fig. 129 Possible symbols for the gas isolator taps

A gas isolator tap (Fig. 129) for every gas device is built into the vehicle.

The gas isolator taps are located in the vehicle at different positions, and can also be fitted separately. Generally, you will have access to the gas isolator taps in the kitchen unit opening a door or a drawer.

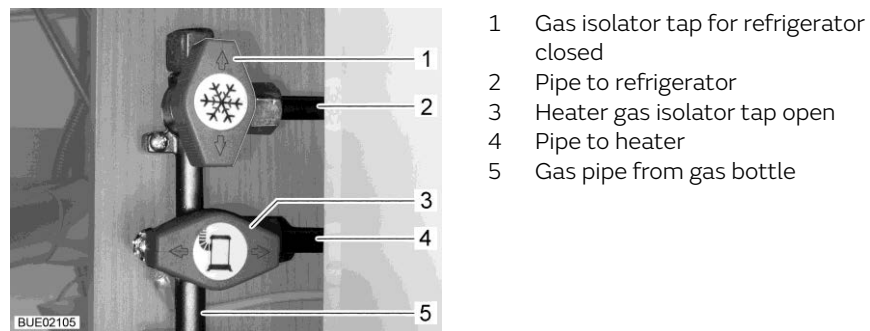

Fig. 130 Gas isolator taps position (example)

- Opening:** ■ Position the gas isolator tap of the corresponding gas device parallel (Fig. 130,3) to the pipe (Fig. 130,4) leading to the gas device.
- Closing:** ■ Position the gas isolator tap of the corresponding gas device transverse (Fig. 130,1) to the pipe (Fig. 130,2) leading to the gas device.

8.4 External gas connection (special equipment)



- ▶ If the external gas connection is not in use, always close the gas isolator tap.
- ▶ Only gas appliances with a suitable adapter should be connected to the external gas connection.
- ▶ Connect only external gas appliances which are designed for an operation pressure of 30 mbar.
- ▶ Once you have made the connection and opened the gas isolator tap, make sure that no gas is escaping at the connection point. If there is a leak in the external gas connection, gas will escape into the open air. Immediately close the gas isolator tap and the regulator tap on the gas bottle. Have the external gas connection checked by an authorised specialist workshop.
- ▶ When connecting an external gas appliance, make sure that there is nothing near the external gas connection that could cause a spark.
- ▶ Only connect a gas appliance to the external gas connection. Do not use the external gas connection as supply (connection of an additional gas bottle).
- ▶ Do not use the external gas connection to fill gas bottles. Observe the information stickers on the external gas connection.

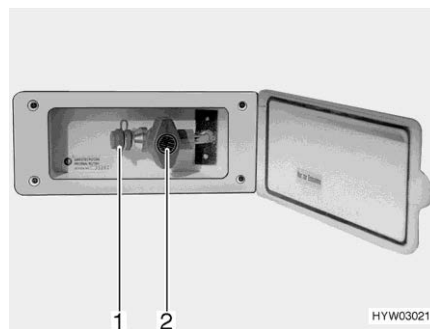

Fig. 131 External gas connection
(gas isolator tap closed)

The external gas connection is located at the rear or to the left or right of the vehicle depending on the model.

- Connect the external gas device to the connection point (Fig. 131,1).
- Open the gas isolator tap (Fig. 131,2).

8.5 Gas bottle switching facility (special equipment)



- ▶ If the vehicle is equipped with a gas bottle switching facility without Crash Protection Unit (CPU), it is not permitted to operate gas devices during the journey. Close the regulator taps on the gas bottles and the gas isolator taps before setting off.



- ▷ When the vehicle is equipped with the crash protection unit the living area heater may be operated during the journey.
- ▷ The gas bottle switching facility and the hose lines shall be changed at the latest 10 years after manufacturing date. The operator is responsible for this.

The automatic switching facility automatically switches gas supply from the primary bottle to the reserve bottle as soon as the primary bottle is either empty or no longer ready for operation. The gas appliances may still continue operation. The switching facility is suitable for all commercial gas bottles from 3 kg to 33 kg.

Facility without Crash Protection Unit (CPU)

The gas bottle switching facility consists of a combined gas pressure regulator with reversing valve and indicator (Fig. 132,3). The gas bottle switching facility is installed between the two gas tubes (Fig. 132,1).

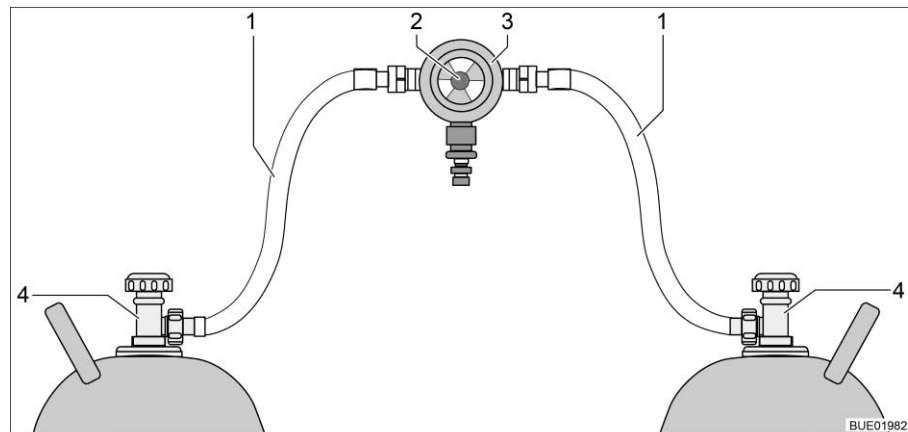

Fig. 132 Gas bottle switching facility

- 1 Gas tube
- 2 Knob for manual switching of the gas bottles
- 3 Gas pressure regulator with reversing valve and indicator
- 4 Regulator tap on the gas bottle

Facility with Crash Protection Unit (CPU)

The gas bottle switching facility consists of a combined gas pressure regulator with reversing valve and indicator (Fig. 133,4), and an electrovalve (Fig. 133,2). The electrovalve blocks the gas supply to the vehicle in the event of a full braking, an accident, or an unusually great inclined position. The gas bottle switching facility is installed between the two gas tubes (Fig. 133,1) with hose break guards (Fig. 133,5).

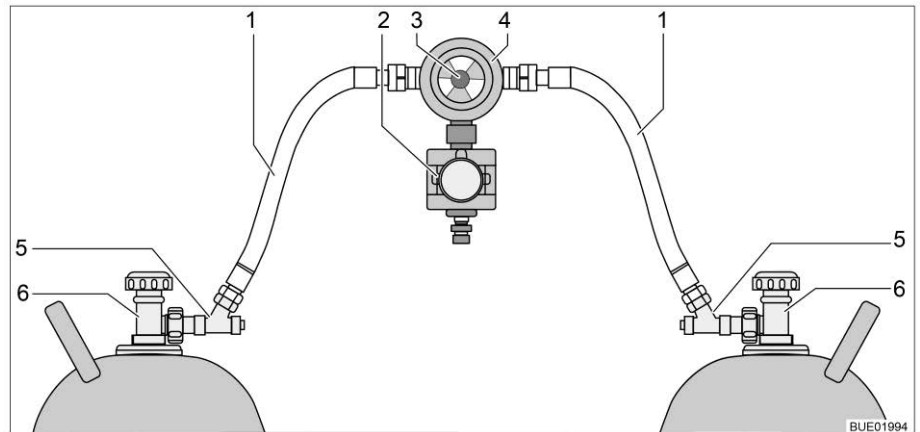

Fig. 133 Gas bottle switching facility with CPU

- 1 Gas tube
- 2 Electrovalve (CPU)
- 3 Knob for manual switching of the gas bottles
- 4 Gas pressure regulator with reversing valve and indicator
- 5 Hose break guard
- 6 Regulator tap on the gas bottle

Function

The gas bottle switching facility ensures a constant gas pressure, regardless of which gas bottle is being drawn upon. The display in the reversing valve shows the filling level of the primary bottle. The gas supply comes from the primary bottle when the display is green. When the display is red the primary bottle is empty. In this case, the reserve bottle is used for the gas supply.

Use the knob (Fig. 132,2 or Fig. 133,3) on the gas bottle switching facility to select which of the gas bottles is to be used as a primary bottle and which is to be used as a reserve bottle.

Operating unit Depending on the equipment, the gas bottle switching facility is additionally equipped with an electrical operating unit (with or without remote display).



Fig. 134 Operating unit



Fig. 135 Operating unit with remote display

Only the electrical functions can be switched at the operating unit (Fig. 134). The regulator taps on the gas bottles (Fig. 132,4 or Fig. 133,6) must be opened and closed manually.

Without remote display The indicator lamp on the operating unit shows the condition of the gas system. The system is okay when the indicator lamp (Fig. 134,1) lights up green. When the indicator lamp lights up or flashes red a fault has occurred. The gas supply is interrupted.

With remote display The indicator lamp on the operating unit (Fig. 135,1) shows the condition of the gas system:

Indicator lamp	Signification
Off	System switched off, gas supply switched off
Green	System switched on, gas supply switched on
Red	Gas supply switched off, triggered by sloping position or excessive acceleration, e.g. in the event of an accident
Yellow	System switched on, gas supply switched on, primary bottle empty
Flashes yellow	Self-check, for approx. 2 seconds, after switching on
Flashes red once	Valve not connected to control unit or internal error
Flashes red twice	Overvoltage determined, gas supply interrupted
Flashes red three times	Undervoltage determined, gas supply interrupted

Putting into operation:

- Open the regulator taps of the gas bottles (Fig. 132,4 or Fig. 133,6).
- Press the hose break guards (Fig. 133,5) successively for 10 seconds.
- Use the knob (Fig. 132,2 or Fig. 133,3) on the switching facility to select the gas bottle which is to be the primary source of gas (primary bottle). Always turn the knob as far as it will go.
- Switch on the switching facility on the operating unit. For this, set the rocker switch (Fig. 134,2 or Fig. 135,2) to "ON". The reversing valve is now deaerated. The indicator lamp (Fig. 134,1 or Fig. 135,1) flashes yellow (system test) and lights up green.

- Switching off:
- Set the rocker switch (Fig. 134,2 or Fig. 135,2) to "OFF". The indicator lamp (Fig. 134,1 or Fig. 135,1) goes out.
 - Close the regulator taps of the gas bottles (Fig. 132,4 or Fig. 133,6).



- ▶ When changing gas bottles, do not smoke or create any open fire.
- ▶ Depending on the connection, unscrew the gas tube from the gas bottle and screw it on the gas bottle again by hand or using a suitable special spanner. The screw connection on the gas bottle generally has a left-hand thread. **Do not** tighten too firmly.

- Changing gas bottles:
- Change the position of the knob of the switching facility. The display is green again.
Should the display stay red the reserve bottle is also empty and has to be changed as well.
 - Close regulator tap on the empty gas bottle.
 - Unscrew the gas tube of the gas bottle.
 - Attach the protective cap to the gas bottle.
 - Release the fixing belts and remove the gas bottle.
 - Place a new gas bottle in the gas bottle compartment.
 - Fix gas bottle in place with the fixing belts.
 - Remove the protective cap from the gas bottle.
 - Connect the full gas bottle to the gas tube.
 - Open the regulator tap on the gas bottle.
 - Press the hose break guard for 10 seconds.
 - Turn the knob on the reversing valve to the changed bottle. Open the release button when the display is green.
 - Set the knob on the reversing valve with a half-turn, so that the newly replaced gas bottle will serve as a reserve bottle.

Chapter overview

This chapter contains instructions regarding the electrical system of the vehicle.

The operation of the electrical appliances of the housing body is described in chapter 10.

9.1 General safety instructions



- ▶ Only allow qualified personnel to work on the electrical system.
- ▶ All electronic devices (e.g. mobile telephones, radios, televisions or DVD players) which have been retrofitted to the vehicle and are operated during the journey must have certain features: These are the CE certification, the EMC inspection (electromagnetic compatibility) and the "e"-inspection.
Only in this way can the functional reliability of the vehicle be ensured. Otherwise the airbag may be triggered or interference to the on-board electronics may result.



- ▷ After the vehicle is started, delays to the output or forwarding of electrical impulses are possible.
The control unit of the basic vehicle does not release the D+ signal until the engine has reached full performance. In the event of a cold start in winter, this can take up to 15 seconds.
For this reason, output of warning signals (such as "entrance step extended") may sometimes be delayed.
The automatic retraction of a SAT antenna can also be delayed.
- ▷ During a storm, to protect the electrical devices disconnect the 230 V connection and retract the antennae.

9.2 Terms

Off-load voltage

The off-load voltage is the voltage of the battery in idle condition, i. e. no current is consumed and the battery is not being charged.



- ▷ The battery must remain idle for a while before measuring. After charging the last time, or after the last current has been drained by appliances, wait approximately 2 hours before measuring the off-load voltage.

Closed circuit current

Some electrical appliances, such as the clock and the indicator lamps, require continuous electric current, for this reason they are referred to as inactive appliances. This closed circuit current flows even if the device has been switched off.

Total discharge Total discharge of the battery is imminent, if a battery is completely discharged by an active appliance and by closed circuit current and the off-load voltage falls below 12 V.



▷ Total discharge damages the battery.

Capacity Capacity refers to the amount of electricity which can be stored in a battery. The capacity of a battery is given in ampere hours (Ah). The so-called K20 value is normally used.

The K20 value indicates how much current a battery is able to dispense over a time period of 20 hours without causing damage, or how much current is required to charge a flat battery within 20 hours.

For example, if a battery can dispense 4 amps for 20 hours, then it has a capacity of $4 \text{ A} \times 20 \text{ h} = 80 \text{ Ah}$.

If more current flows, the discharging time of the battery will decrease proportionately.

External influences, such as temperature and age may alter the storage capacity of the battery. Capacity details refer to new batteries operating at room temperature.



▷ Depending on battery technology, capacity details have a conversion factor of 1.3 to 1.7, which lowers the real capacity by this value.

9.3 USB socket (partially special equipment)



▷ The charging current is maximum 1 amp.

The vehicle is equipped with one or more USB sockets.

All USB devices can be connected and charged via this USB socket.



Fig. 136 USB socket

9.4 12 V power supply



- ▷ Only connect devices with a maximum of 10 A to the sockets (Fig. 137,1) of the 12 V power supply.

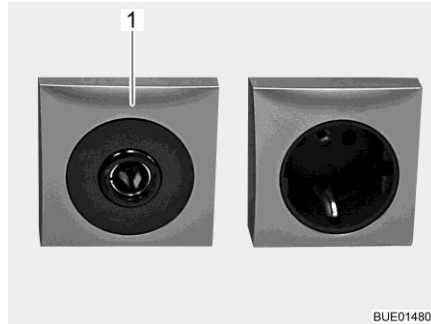

Fig. 137 12 V/10 A socket

9.4.1 Selector switch for power supply of the multimedia system (special equipment)

Depending on the equipment, a multimedia system may be installed in the vehicle.

Depending on the model of the multimedia system, it may be possible to choose whether power to the multimedia system is supplied by the starter battery or by the living area battery.



Fig. 138 Selector switch for power supply

Power supply by starter battery:

- Set the selector switch to the "0" position. The multimedia system will be switched on and off with the ignition.

Power supply by living area battery:

- Set the selector switch to the "T" position. The multimedia system can also be operated while the ignition is switched off.

9.4.2 Starter battery

The starter battery serves for starting the engine and supplies the electrical appliances of the base vehicle as well as optional devices such as the radio, navigation system or central locking system with voltage.



- ▷ Total discharge damages the battery. The consequence may be deformation, heat development, and damage due to scorching.
- ▷ Once a battery with acid is discharged, it can freeze in temperatures of below zero. This damages the battery.
- ▷ Recharge battery in good time.

The starter battery will be totally discharged via a closed circuit current (inactive appliances). Inactive appliances are optional devices such as a radio, alarm system, navigation system or a central locking system. Inactive appliances discharge the starter battery when the vehicle engine is switched off. Low temperatures outside reduce the capacity available.

Charging Safety instructions and information on charging the starter battery, see instruction manual of the base vehicle.

Position See instruction manual of the base vehicle.

9.4.3 Living area battery



- ▷ Use only the built-in transformer/rectifier to load the living area battery. In order to do this, connect the 230 V connection (CEE connector) of the vehicle to an external 230 V power supply.
- ▷ After the trip, charge the living area battery fully.
- ▷ Before a temporary lay-up, charge the battery fully.
- ▷ When the living area battery is changed, only use batteries of the same type and the same capacity.
- ▷ If there are several living area batteries, always change all the batteries together. The batteries must **always** be the same age and have the same capacity.
- ▷ When changing the living area battery, use only batteries which meet the minimum capacity of the charger. Observe the separate instruction manual for the charger. Lower-capacity batteries will generate a great deal of heat when they are charged. Danger of explosion!
- ▷ If the living area battery is replaced and the charging unit does not provide at least 10 % of the rating of a new battery, install an auxiliary charging unit. Example: With a battery capacity of 80 Ah, the charging unit must supply at least 8 A charging current.
- ▷ Before disconnecting or connecting the terminals of the battery, switch off the vehicle engine as well as the 230 V and 12 V power supplies and all appliances. Danger of short circuit!



- ▷ If the starter battery or living area battery are disconnected, do not apply the ignition. There is a danger of short circuit from exposed cable ends.
- ▷ Take note of the battery manufacturer's users and maintenance instructions.



- ▷ If possible, begin the trip with a fully charged living area battery. Therefore, charge the living area battery before starting the trip.
- ▷ During the trip, use every available opportunity to charge the living area battery.
- ▷ The radio device in the driver's cabin is connected to the living area battery.
- ▷ The battery is maintenance-free. Maintenance-free means:
It is not necessary to check the acid level.
It is not necessary to lubricate the battery poles.
It is not necessary to refill the distilled water.
Even a maintenance-free battery must be recharged.
Recommendation: Perform a full charging cycle every 6 to 8 weeks. Depending on the battery capacity and the charger, the charging cycle will last 24 to 48 hours.

When the vehicle is not connected to the 230 V power supply or the 230 V power supply is switched off, the living area battery supplies the living area with 12 V DC. The living area battery has a limited power supply only. For this reason, electrical appliances such as the radio and the lights should not be operated for a long time without using the 230 V power supply.

Position See chapter 17.

Discharging The living area battery is discharged by the closed circuit current which some electrical appliances continuously require.



- ▷ Total discharge damages the battery.
- ▷ Recharge battery in good time.



- ▷ Appliances such as the refrigerator, charger, solar charge regulator, panel, or similar, take power from the battery, even when the 12 V main switch is turned off. Therefore disconnect the living area battery from the 12 V power supply, if the vehicle will not be used for a long period of time.

Even a fully charged living area battery can, after an extended period, be fully discharged via a closed-circuit current (inactive appliances).

Low temperatures outside reduce the capacity available.

The self-discharge rate of the battery is also dependant on temperature. At 20 to 25 °C the self-discharge rate is approx. 3 % of the capacity per month. The self-discharge rate will increase with rising temperatures.

An older battery no longer has the complete capacity available.

The higher the number of active electrical appliances, the faster the energy of the living area battery is consumed.

9.4.4 Charging batteries via a 230 V power supply

If the vehicle is connected to the 230 V power supply, the living area battery and the starter battery are automatically charged by the charger module on the transformer/rectifier. The starter battery is only charged with a float charge. The charging current is adapted to suit the charging condition of the battery. This ensures that it is not possible to overload the battery.

To make use of the maximum output from the charger module on the transformer/rectifier, switch off all electrical appliances during charging.

9.4.5 Charging batteries via the vehicle engine

When the vehicle engine is running, the vehicle alternator recharges the living area battery and the starter battery. When the vehicle engine is switched off, the batteries are automatically disconnected from one another by a relay in the transformer/rectifier. This prevents the starter battery from being run down by electrical appliances in the living area. The starting capability of the vehicle is thus preserved. The charging condition of the living area battery or the starter battery can be read on the panel.

9.5 Charging booster for the living area battery



- ▶ Do not carry out any maintenance or repair work on the device. There is an electrical shock hazard and risk of fire.
- ▶ If the housing or the cables are damaged: do not put the device into operation. Disconnect device from the power supply.
- ▶ Make sure that no liquids enter the device.
- ▶ Device components can get hot during operation. Do not touch the device.
Do not store any heat sensitive objects close to the device.



- ▷ Only use battery types as living area battery which are supported by the charging booster.
- ▷ In the event of a change of battery type: have the charging booster reset and re-programmed at a service centre.

During the journey, the living area battery is charged by the vehicle's alternator. Fluctuations in the charging current and a drop in voltage between the alternator and the living area battery affect the battery's performance. The charging booster is used to keep the charging current of the alternator constant and to compensate for any drops in voltage.

The charging booster has been set in the factory for the living area battery used and works automatically. No operating actions are required.

In the event of a high heat development, a built-in fan prevents the charging booster from overheating.

For any information about the fuse of the voltage sensor, see section 9.10.1.

Position

The charging booster is installed underneath the driver's seat (next to the transformer/rectifier).

9.6 Transformer/rectifier (EBL 223)



- ▶ Potentially fatal electric shock or fire hazard.
In the event of a malfunction or damage, some parts of the device may be connected to line voltage.
 - Do not carry out any maintenance or repair work on the unit.
 - Do not open the device.
 - Do not bring liquid into the device.
 - In the event of damage on the cables or the housing, do not put the device into operation and disconnect it from the line voltage.



- ▷ Do not cover the ventilation slots. Danger of overheating!



- ▷ Depending on the model, not all slots for the fuses are occupied.
- ▷ If there are several living area batteries, use an auxiliary charging unit.
- ▷ Further information can be obtained in the device manufacturer's instruction manual.

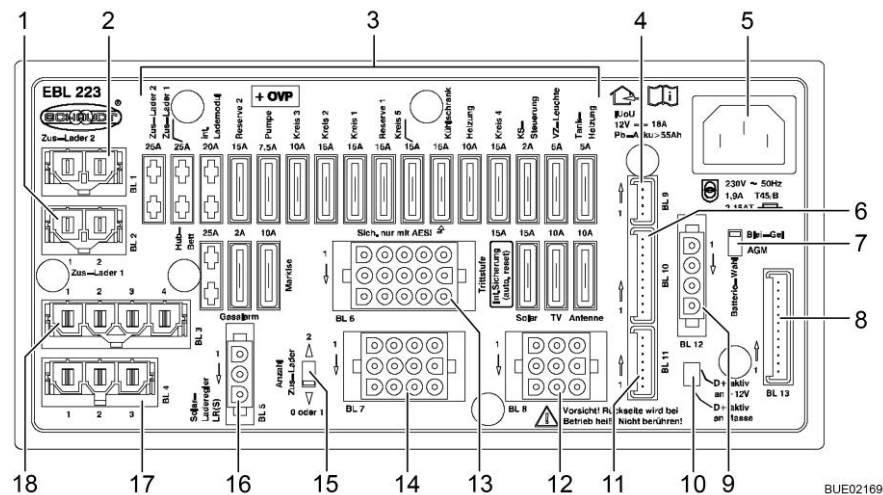

Fig. 139 Transformer/rectifier (EBL 223)

- 1 Connections BL 2 - auxiliary charging unit 1
- 2 Connections BL 1 - auxiliary charging unit 2
- 3 Flat fuses
- 4 Connections BL 9 - solar charge regulator
- 5 Mains connection 230 V
- 6 Connections BL 10 - panel
- 7 Battery selector switch (lead-gel/AGM)
- 8 Connections BL 13 - panel
- 9 Connections BL 12 - sensor for living area battery D+
- 10 Change-over switch D+ active to +12 V (D+ active to ground (factory setting))
- 11 Connections BL 11 - panel
- 12 Connections BL 8 - entrance step, TV, antenna
- 13 Connections BL 6 - heater, water pump, spare
- 14 Connections BL 7 - awning, tank heater, awning light
- 15 Selector switch for the number of auxiliary charging units
- 16 Connections BL 5 - solar charge regulator
- 17 Connections BL 4 - refrigerator from starter battery
- 18 Connections BL 3 - refrigerator

Functions The transformer/rectifier has the following functions:

- The transformer/rectifier charges the living area battery. The transformer/rectifier charges the starter battery with a float charge.
- The transformer/rectifier monitors the voltage in the living area battery.
- The transformer/rectifier distributes the current to the 12 V circuits and secures them. Devices with a maximum of 10 A can be connected to the sockets.
- The transformer/rectifier provides connections for a solar charge regulator, an auxiliary charging unit, as well as other control and monitoring functions.
- When the vehicle engine is turned off, the transformer/rectifier separates the starter battery electrically from the living area battery. This prevents the 12 V living area appliances from discharging the starter battery.

The transformer/rectifier only works in conjunction with a panel.

The power in the transformer/rectifier (≤ 18 A) is divided into charging current and current to the appliances. The charging current is always just the portion that is not being used by any appliances. If the current to the appliances exceeds the current available, then the living area battery is discharged.

The power supply of pull-down bed, awning, waste water tap, and awning light is disconnected automatically when the vehicle engine is running.

Position See chapter 17.

9.6.1 Battery separation



- ▷ Also switch off a refrigerator with automatic power selection system. The refrigerator will otherwise switch to gas operation.
- ▷ After deactivation of the battery separation, it may be necessary to re-set the date and time. The remaining settings will be saved at the activation of the battery separation and will be maintained.

The battery separation switches off **all** 12 V appliances in the living area, even inactive ones. Even appliances such as the entrance step, basic lighting or the refrigerator will stop working. This prevents the living area battery from slowly discharging if the vehicle is not used for a longer period of time (e.g. temporary lay-up).

If the vehicle is connected to the 230 V power supply, the batteries can then be charged from the transformer/rectifier, even if the battery separation is activated.

This also applies for charging via a solar installation or fuel cell.

Activating/deactivating See section 9.7.2.

9.6.2 Battery selector switch



- ▶ If the battery selector switch is set incorrectly, there is a risk of generating oxyhydrogen gas. Danger of explosion!



- ▷ Incorrect setting of the battery selector switch damages the living area battery.
- ▷ The factory settings of the battery selector switch must not be changed.

9.6.3 Battery monitor



- ▷ You must fully recharge a discharged living area battery as soon as possible.

The battery monitor in the transformer/rectifier monitors the voltage in the living area battery.

If the voltage of the batteries falls below 10.5 V, the battery monitor in the transformer/rectifier switches off all the 12 V appliances.

- Measures:
- Switch off all electrical appliances that are not absolutely essential at the corresponding switch.
 - If necessary, use the 12 V main switch to switch the 12 V power supply back on for a short while. This is only possible, however, when the battery voltage is above 11 V. If the voltage is below this level, the 12 V power supply cannot be switched on again until the living area battery has been recharged.

9.6.4 Charging the battery

When the vehicle engine is running, a relay in the transformer/rectifier alternator switches on the living area battery and the starter battery together and recharges them with the vehicle generator. When the vehicle engine is switched off, the batteries are automatically disconnected from one another again by the transformer/rectifier. This prevents the starter battery from being run down by electrical appliances in the living area. The starting capability of the vehicle is thus preserved. The terminal voltage of the living area battery or the starter battery can be read on the panel.

If the vehicle is connected to the 230 V power supply via the CEE socket outlet, the living area battery and the starter battery are charged by the charger module on the transformer/rectifier. The starter battery is only charged with a float charge. The charging current is adapted to suit the charging condition of the battery. This ensures that it is not possible to overload the battery.

To make use of the maximum output from the charger module on the transformer/rectifier, switch off all electrical appliances during charging.

9.6.5 Entrance step

After an overload, the self-resetting fuse will reset automatically within approx. 1 minute.

9.6.6 Solar charge regulator

Before removing or changing the living area battery, disconnect the connector of the solar charge regulator from the transformer/rectifier.

9.7 Panel LT 511



- ▷ The luminance of the LEDs and the symbols adapts automatically to the ambient light.
- ▷ The displays can only be called up if the 12 V power supply is switched on.
- ▷ As soon as a button is pressed, the gauge is automatically illuminated. The display goes out 20 seconds after the last key has been pressed.
- ▷ Further information can be obtained in the manufacturer's instruction manual.

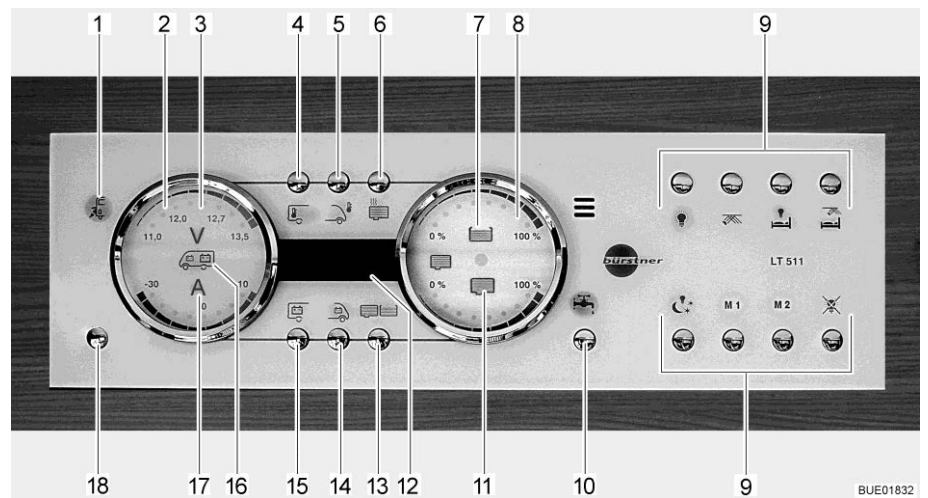

Fig. 140 Panel LT 511

- 1 230 V indicator lamp
- 2 Batteries gauge
- 3 Volt symbol
- 4 Interior temperature button
- 5 External temperature button
- 6 Not used/without function
- 7 Water tank symbol
- 8 Tanks gauge
- 9 Light control button
- 10 Water pump button
- 11 Waste water tank symbol
- 12 Digital display, temperature
- 13 Tanks button
- 14 Starter battery button
- 15 Living area battery button
- 16 Symbol for starter battery and living area battery
- 17 Ampere symbol
- 18 Button for 12 V power supply (12 V main switch)

9.7.1 230 V indicator lamp

The 230 V indicator lamp (Fig. 140,1) illuminates whenever line voltage is available at the transformer/rectifier input.



- ▷ The 230 V indicator lamp also lights up whenever the 12 V main switch is switched off.

9.7.2 12 V main switch

The 12 V main switch (Fig. 140,18) switches the panel and the 12 V power supply of the living area on and off.

Exception: Heater, basic light (lighting in the entrance area) and entrance step remain operational.

Switching on: Briefly press the 12 V power supply button (Fig. 140,18). The 12 V living area power supply is switched on. The "12 V" indicator lights up.



- ▷ If, after switching on, the "11.0" LED of the volt indicator and the "V" volt symbol (Fig. 140,3) in the batteries gauge (Fig. 140,2) flash, the voltage of the living area battery is too low. Charge battery.
- ▷ If, after switching on, the "12 V" indicator and the "V" volt symbol (Fig. 140,3) flash three times, battery separation is activated. Deactivate battery separation.

Switching off: ■ Briefly press the 12 V power supply button (Fig. 140,18). The 12 V living area power supply is switched off. The "12 V power supply" indicator goes out.

Activating battery separation (transformer/rectifier without battery cut-off switch):

- Switch off 12 V power supply.
- Press button for living area battery (Fig. 140,15) and hold it down for approx. 10 seconds. The "V" volt symbol (Fig. 140,3) and the "12 V" indicator flash three times. The living area battery is disconnected from the 12 V power supply.

Deactivating battery separation (transformer/rectifier without battery cut-off switch):

- Press the 12 V power supply button (Fig. 140,18) and hold it down for approx. 5 seconds. The "V" volt symbol (Fig. 140,3) and the "12 V" indicator flash three times. The living area battery is connected to the 12 V power supply. The indicator lights up after approx. 5 seconds.



- ▷ When leaving the vehicle, switch off the main 12 V power supply at the panel. This prevents any unnecessary discharge of the living area battery.
- ▷ Appliances, such as control units (e.g. solar charge regulator, defroster or panel) or fitted appliances (e.g. heater, refrigerator or step) continue to take power from the battery capacity, even if the 12 V power supply on the panel is switched off. Therefore disconnect the living area battery from the 12 V power supply via the switch on the transformer/rectifier if the vehicle will not be used for a long period of time.

9.7.3 Batteries gauge

The voltage and charging/discharging of the living area battery or the starter battery voltage can be indicated using the batteries gauge.

- Displays:**
- Press button for living area battery (Fig. 140,15). The "V" volt symbol (Fig. 140,3) lights up. The "A" ampere symbol (Fig. 140,17) lights up as either white or red depending on whether it is charging or discharging. The battery voltage and electricity of the living area battery are displayed via the LEDs in the gauge.
 - Press button for starter battery (Fig. 140,14). The "V" volt symbol (Fig. 140,3) lights up. The battery voltage of the starter battery is displayed using the LEDs in the gauge.

The following tables will help you interpret the statuses displayed on the panel.

Volt indicator (blue)

1 LED	2 LEDs	3 LEDs	4 LEDs	5 LEDs	6 LEDs	7 LEDs	8 LEDs
< 11,0 V	11,5 V	12,0 V	12,2 V	12,5 V	12,7 V	13,0 V	> 13,5 V

Danger of total discharge (battery alarm)

Battery voltage (values during operation)	Mobile operation (vehicle moving, no 230 V connection)	Battery operation (vehicle stationary, no 230 V connection)	Power operation (vehicle stationary, 230 V connection)
11 V or less ¹⁾	12 V power supply overload The battery is not charged by the alternator, the alternator's regulator is defective	If appliances are switched off: Battery flat If appliances are switched on: Battery overload	12 V power supply overload The battery is not charged by the transformer/rectifier, the transformer/rectifier is defective
11.5 V to 13 V	12 V power supply overload ²⁾ The battery is not charged by the alternator, the alternator's regulator is defective	Normal range	12 V power supply overload ²⁾ The battery is not charged by the transformer/rectifier, the transformer/rectifier is defective
Over 13.5 V	Battery is being charged (main charge)	Occurs only briefly after charging	Battery is being charged (main charge)

¹⁾ The battery guard switches all the appliances off (at 10.5 V).

²⁾ If the voltage does not exceed this range for several hours.

Values for off-load voltage	Charging condition of the battery
12.0 V or less	Discharge or totally discharge
12.2 V	25 %
12.3 V	50 %
More than 12.8 V	Full



- ▷ Total discharge causes irreparable damage to the battery.



- ▷ Measure the off-load voltage preferably several hours after the previous charging (e.g. in the morning) and not directly after a current drain.

Ampere indicator (blue)

1 LED	2 LEDs	3 LEDs	4 LEDs	5 LEDs	2 LEDs	3 LEDs	4 LEDs
Discharging with:					Charging with:		
Approx. 0 A	> 1 A	> 3 A	> 10 A	> 30 A	> 1 A	> 3 A	> 10 A

Current displayed	System status	"A" ampere symbol
-30 A to -10 A	Battery is being heavily discharged	Lights up red
-10 A to -1 A	Battery is being discharged	Lights up white
0 A	Battery current is low or 0 A	Lights up white
+1 A to +10 A	Battery is being charged	Lights up white

9.7.4 Tank gauge

The water and waste water quantities can be indicated using the tank gauge.

- Displays:
- Press tanks button (Fig. 140,13). The water tank (Fig. 140,7) and waste water tank (Fig. 140,11) symbols light up. The fill levels of the water tank (upper scale) and of the waste water tank (lower scale) are indicated using the LEDs in the gauge.

The table below will help you interpret the levels displayed on the panel.

Level indicator (blue)

1 LED	2 LEDs	3 LEDs	4 LEDs	5 LEDs	6 LEDs	7 LEDs	8 LEDs
25 %		50 %		75 %		100 %	

9.7.5 Alarms



- ▷ Perform display checks regularly.
- ▷ It is best to perform checks in the morning, before the 12 V appliances are switched on.

The table below will help you interpret the alarms displayed on the panel.



- ▷ Total discharge damages the battery.



- ▷ If the voltage of the batteries falls below 10.5 V, the battery monitor in the transformer/rectifier switches off all the 12 V appliances. The battery cut-off switch is tripped.

Display	Signification	Remedy
The "V" volt symbol (Fig. 140,3) and the LED "11.0" flash when the values for the living area battery are called up	The battery voltage has fallen below 11 V. Danger of total discharge	Switch off all 12 V appliances and charge the battery either by mobile operation or by connection to a 230 V supply
The "V" volt symbol (Fig. 140,3) flashes when the 12 V power supply is switched off	The 12 V power supply can no longer be switched on	Switch off all 12 V appliances and charge the battery either by mobile operation or by connection to a 230 V supply
	Battery overvoltage	Contact customer service
The "V" volt symbol (Fig. 140,3) and the LEDs "11.0" and "12.0" flash when the values for the starter battery are called up	The battery voltage has fallen below 11 V. Danger of total discharge	Switch off all 12 V appliances and charge the battery either by mobile operation or by connection to a 230 V supply

Tank alarm The water tank symbol (Fig. 140,7) or waste water tank symbol (Fig. 140,11) flashes when the water tank is empty or the waste water tank is full.



- ▷ If, when the fill levels are called up, the LEDs in the scale flash in addition to the tank symbol, a sensor error has occurred. Clean tank sensors.

Measures: ■ Fill water tank or empty waste water tank.

9.7.6 Temperature display

The internal and external temperatures can be indicated using the digital display (Fig. 140,12).

- Displays:**
- Press the button for the internal temperature (Fig. 140,4). The internal temperature is displayed.
 - Press external temperature button (Fig. 140,5). The external temperature is displayed.

9.7.7 Switch for water pump

The water pump can be turned on and off using the water pump button (Fig. 140,10).

Switching on: ■ Press the water pump button (Fig. 140,10). The symbol lights up.

Switching off: ■ Press the water pump button (Fig. 140,10). The symbol goes out.



- ▷ The switch status of the water pump is saved when the 12 V power supply is switched off. This means: If the water pump was switched on when the 12 V power supply was switched off, it is also switched on after the 12 V power supply is switched back on.

9.8 Solar installation (special equipment)



- ▷ Protect the solar collectors (solar module) against mechanical overload.



- ▷ The solar installation supplies the most current under optimal sunlight conditions.
- ▷ Provide the solar collectors (solar module) open access to sunlight.
- ▷ Sunlight is greater in the open air than under trees and bridges.
- ▷ Tarpaulins block out sunlight.
- ▷ Always keep collector surfaces free of contamination.
- ▷ Also read the manufacturer's instruction manual.

The solar installation provides an environmentally compatible power supply independent of the mains. It converts energy from sunlight into electric current. The solar installation supplies additional current for the battery and appliances.

The solar charge regulator has an integrated overload protection as well as deep discharge protection.

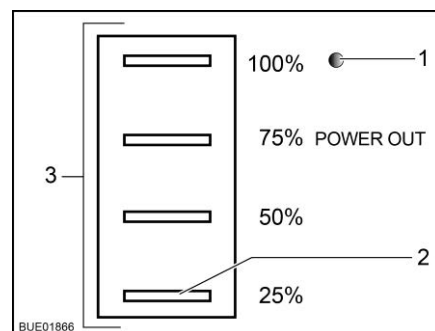

Fig. 141 Status indicator, solar charge regulator

Four LEDs (Fig. 141,3) show the current operating state. Another LED (Fig. 141,1) shows whether output voltage is present.

LED	Status	Signification
Operating state LEDs (Fig. 141,3)	Flashing cyclically	Battery being charged
	Lit up	Battery is fully charged
LED 25 % (Fig. 141,2)	Flashes	Battery is fully discharged
Output voltage LED (Fig. 141,1)	Lit up	Output voltage present
	Not lit up	Output voltage not present

9.9 230 V power supply



- ▶ Only allow qualified personnel to work on the electrical system.
- ▶ Have the vehicle's electrical system checked by a qualified electrician at least once every 3 years. If the vehicle is used frequently, an annual check is recommended.

The 230 V power supply provides electricity for the following devices (if present):

- sockets with earth contact for appliances with maximum 10 A
- refrigerator
- transformer/rectifier
- an auxiliary charging unit
- air conditioning unit

The electrical appliances connected to the 12 V power supply of the living area are supplied with voltage by the living area battery.

Connect the vehicle to an external 230 V power supply system as often as possible. The charger module in the transformer/rectifier automatically charges the living area battery. In addition to this, the starter battery is charged with a float charge of 2 A.

Depending on the equipment, optional devices are fuse-protected by their own two-pole automatic circuit breaker.

9.9.1 230 V connection (CEE socket outlet)



- ▷ Overvoltage can damage connected devices. Overvoltage can be caused by lightning, irregular voltage sources (e.g. petrol-operated generators) or power connections on ferries for example.

Requirements concerning the 230 V connection

- The connecting cable, the plug connectors at the point of supply and the plug connector to the vehicle must comply with IEC 60309. The standard designation for the plug connectors is "CEE blue".
- Use H07RN-F rubber sheathed cable with a minimum cable cross-section of 2.5 mm² and a maximum length of 25 m.
- Earth contact connectors (safety) are not permitted. The interconnection of CEE/safety adapters is also prohibited.

9.9.2 Connecting the 230 V power supply



- ▶ The external 230 V power supply must be protected by fuse with a fault current protection switch (FI-switch, 30 mA).
- ▶ To prevent overheating, the cable must be fully uncoiled from the cable reel.
- ▶ In case of doubt or if the 230 V supply is not available or is faulty, contact the operator of the power supply device.



- ▷ The 230 V connection in the vehicle is equipped with a combined fault current protection switch with safety cut-out.
- ▷ Depending on the equipment, an additional safety cut-out is installed in the fuse box.
- ▷ For the connection points on camp sites (camping distributors) fault current protection switches (FI-switches, 30 mA) are obligatory.

The vehicle can be connected to an external 230 V power supply.

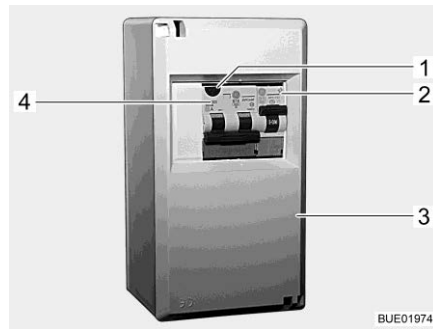

Fig. 142 230 V fuse box with safety cut-out and FI-switch



Fig. 143 230 V connection on the vehicle

Connecting the vehicle:

- Check whether the power supply device is suitable regarding connection, voltage, frequency and current.
- Check whether the cables and connections are suitable.
- Check the plug connectors and cables for visible damage.
- Switch off the safety cut-out (Fig. 142,2 and 4) in the fuse box (Fig. 142,3).
- Open the cover of the 230 V connection on the vehicle (Fig. 143) and insert the plug connector.
- Plug the connector of the connecting cable into the socket of the power supply device.
- Switch on the safety cut-out in the fuse box.

Checking the fault current protection switch:

- When the vehicle is connected to the 230 V supply, press the test button (Fig. 142,1) of the fault current protection switch / safety cut-out (Fig. 142,4) in the fuse box (Fig. 142,3). The fault current protection switch must trip.
- Switch the fault current protection switch back on again.

Unplugging the connection:

- Switch off the safety cut-outs (Fig. 142,2 and 4) in the fuse box (Fig. 142,3).
- On the power supply device, unplug the connector of the connecting cable from the socket.
- On the vehicle, unplug the plug connector and close the cover of the 230 V connection.

9.10 Fuses



- ▶ Only replace defective fuses when the cause of the defect is known and has been remedied.
- ▶ Replace defective fuses only after the power supply has been turned off.
- ▶ Never bridge or repair fuses.
- ▶ Only replace faulty fuses with a new fuse with the same rating.

9.10.1 12 V fuses

The appliances connected to the 12 V power supply in the living area are fused individually. The fuses are accessible at different positions in the vehicle.

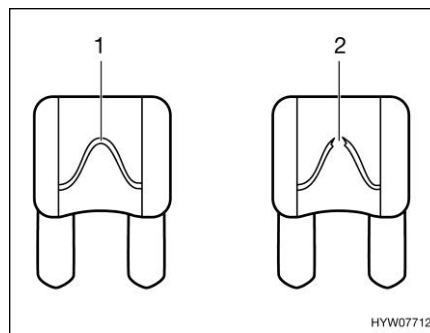

- 1 Unbroken fuse element
- 2 Broken fuse element

Fig. 144 12 V fuse

An intact 12 V fuse can be detected by the unbroken fuse element (Fig. 144,1). If the fuse element is broken (Fig. 144,2), change the fuse.

Before changing fuses, take the function, value and colour of the relevant fuses from the following specifications. When changing fuses, only use flat fuses with the values shown below.

Fuses on the starter battery

The fuses are installed in the vicinity of the starter battery. The starter battery is on the floor between the seats in the driver's cabin and can be accessed under a cover.

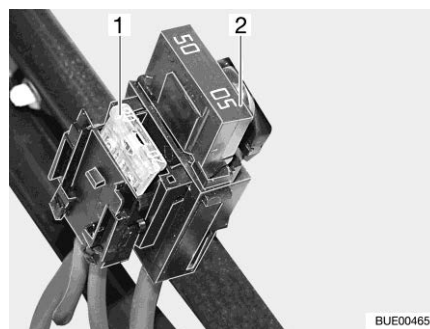

- 1 Flat fuse 20 A/yellow (for refrigerator)
- 2 Jumbo flat fuse 50 A/red

Fig. 145 Fuses on the starter battery

Fuses on the living area battery

The fuses are fitted next to the living area battery.

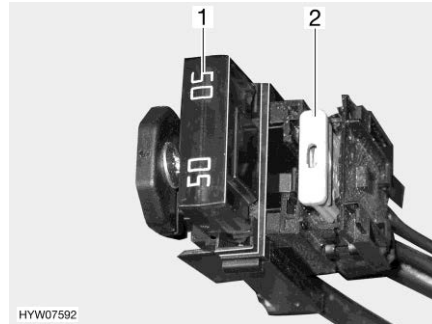

Fig. 146 Fuses on the living area battery

- 1 Jumbo flat fuse 50 A/red (for transformer/rectifier)
- 2 Flat fuse 2 A/grey (for battery sensor, living area battery)

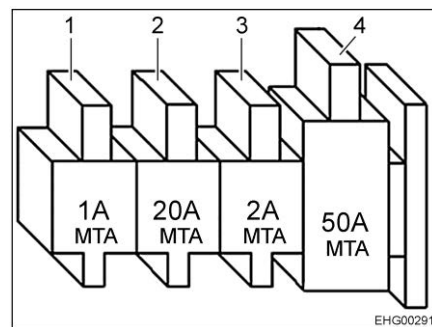

Fig. 147 Fuses (living area battery with charging booster)

- 1 Flat fuse 1 A/black (for voltage sensor, charging booster)
- 2 Flat fuse 20 A/yellow (for refrigerator)
- 3 Flat fuse 2 A/grey (for voltage sensor, transformer/rectifier)
- 4 Jumbo flat fuse 50 A/red (for transformer/rectifier)

Fuses on the relay box AD01

A relay box (AD01) is installed in one of the two seat consoles. The relay box helps generate the signals for the chassis lighting not provided by the base vehicle. The relay box can be used anywhere.

The circuit used by us can vary from the circuit provided by the manufacturer. Consequently, the circuit can also vary from the display on the relay box type plate, which the manufacturer affixed.

Fu No	Function	Value/colour
B2	Cl. 15 (ignition on)	15 A blue
B3	Cl. 30 (constant positive)	15 A blue
B5	Signal D+	Internal Polyswitch (2 A)
B6	Spare	15 A blue
B7	Front side marker lights (white/red)	5 A light brown

Fuses on the transformer/rectifier EBL 223

Function	Value/colour
Auxiliary charging unit 2	25 A white
Auxiliary charging unit 1	25 A white
Internal charger module	20 A yellow
Spare 2	15 A blue
Pump (for water)	7.5 A brown
Circuit 3	10 A red
Circuit 2	15 A blue
Circuit 1	15 A blue
Spare 1	15 A blue
Circuit 5	15 A blue
Refrigerator	15 A blue
Heater	10 A red
Circuit 4	15 A blue
Refrigerator control	2 A grey
Awning light	5 A light brown
Tank heater	5 A light brown
Antenna	10 A red
TV	10 A red
Solar	15 A blue
Step (self-resetting)	15 A
Awning	10 A red
Gas alarm	2 A grey
Pull-down bed	25 A white

Fuses for the air suspension

The fuses are installed in the base vehicle's fuse box.

Function	Value/colour
Control	7.5 A brown
Compressor	40 A green

**Fuse for the Thetford toilet
(swivel toilet)**

The fuse is located in the locker wall of the Thetford cassette.

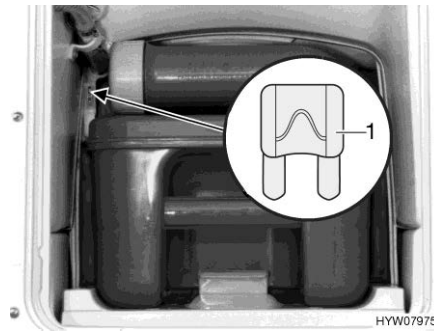

1 Flat fuse 3 A/purple

Fig. 148 Fuse for the Thetford toilet

Changing:

- Open the flap for the Thetford cassette on the outside of the vehicle.
- Pull out the Thetford cassette completely.
- Replace fuse (Fig. 148,1).

**Fuse for the Thetford toilet
(swivel toilet C-260)**

The toilet has a maintenance-free fuse which resets automatically.

Pull-down bed fuse

The motor of the pull-down bed is protected by the fuse Circuit 5 on the transformer/rectifier. The control is protected by a self-restoring Polyswitch fuse on the transformer/rectifier.

**Fuse for waste water
heating**

The control unit has an electronic overload protection. In the event of an overload, the waste water heating switches off. To restart, disconnect the control unit briefly from the power supply.

Depending on the model, the supply voltage of the waste water heating will be protected by the fuse circuit Spare 3 or Spare 4.

9.10.2 230 V fuse



- ▷ Check the fault current protection switch for each connection to the 230 V power supply, at least once every 6 months.



- ▷ In international language usage, the fault current protection switch is also denominated RCD (Residual Current Device).

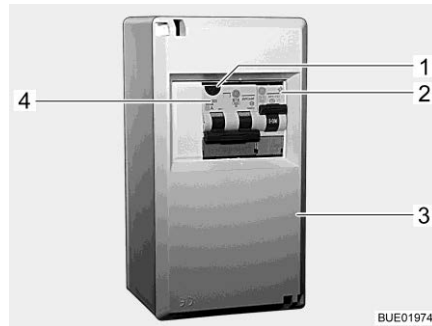

Fig. 149 230 V fuse box

A combined fault current protection switch / safety cut-out (Fig. 149,4) in the fuse box (Fig. 149,3) protects the complete vehicle from fault current (0.03 A).

The integrated safety cut-out (16 A) protects the 230 V sockets, the power supply unit, the auxiliary charging unit, and the refrigerator.

For vehicles with special equipment (e.g. air conditioning unit) an additional safety cut-out (10 A) (Fig. 149,2) secures the device.

Checking the fault current protection switch:

- When the vehicle is connected to the 230 V power supply, press the test button (Fig. 149,1). The fault current protection switch must trip.

Position See chapter 17.

9.11 External socket (special equipment)

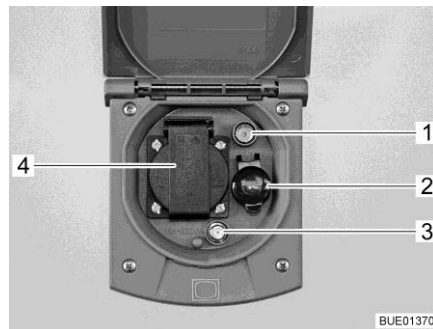

- 1 TV socket
- 2 12 V socket
- 3 SAT socket
- 4 230 V socket

Fig. 150 External socket

The 230 V socket and the 12 V socket can be used to power electrical devices in the awning.

Connection possibilities

TV socket and SAT socket offer various possibilities for TV operation:

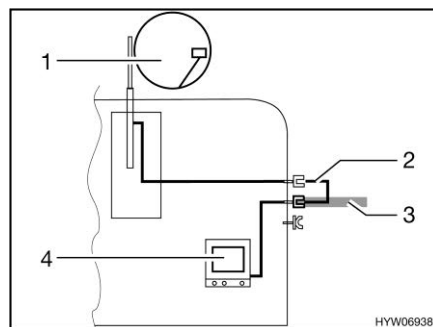

Fig. 151 TV inside the vehicle

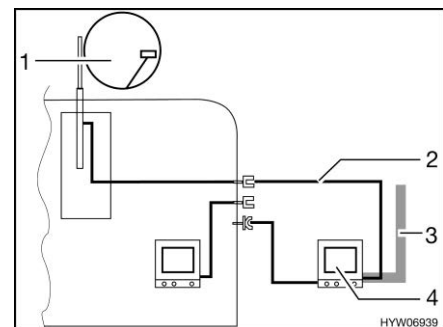
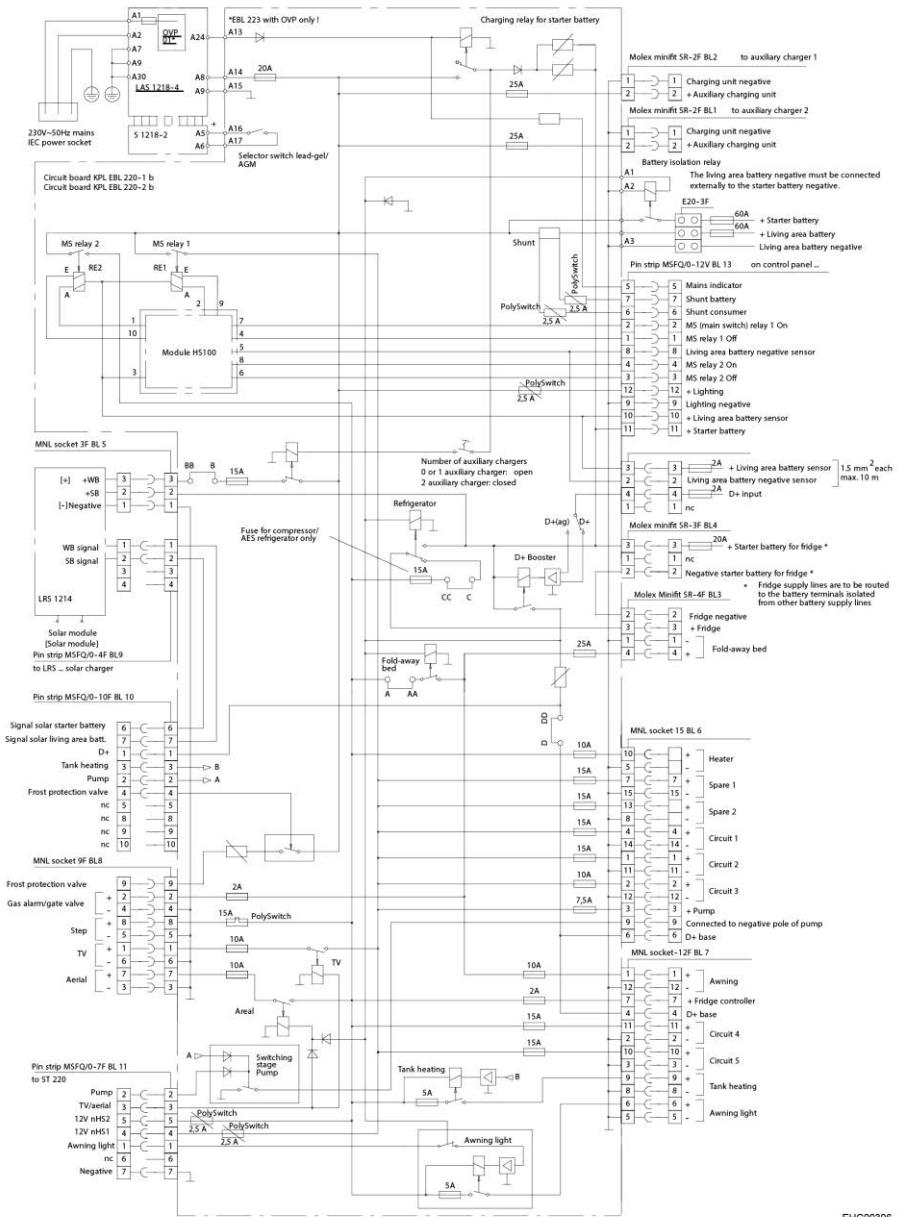

Fig. 152 TV in the awning

- TV inside the vehicle (Fig. 151,4): Connection to roof antenna (Fig. 151,1) with connection cable (Fig. 151,2)
- TV inside the vehicle (Fig. 151,4): Connection to external antenna (Fig. 151,3)
- TV inside the awning (Fig. 152,4): Connection to roof antenna (Fig. 152,1) with connection cable (Fig. 152,2)
- TV inside the awning (Fig. 152,4): Connection to external antenna (Fig. 152,3)

9.12 Circuit diagrams
9.12.1 Circuit diagrams, interior



EHG00306

Fig. 153 Circuit diagram, interior (EBL 223)

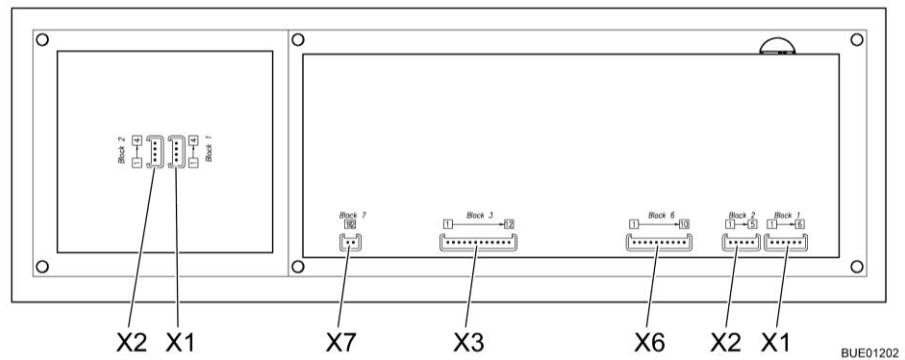

Fig. 154 Block diagram, panel (LT 511)

X1	Lumberg MSFQ 6-pin
1	Full
2	3/4
3	1/2
4	1/4
5	Base water tank
6	n. c.
X2	Lumberg MSFQ 5-pin
1	Full
2	3/4
3	1/2
4	1/4
5	Base waste water tank
X3	Lumberg MSFQ 12-pin
1	Main switch relay 1 off
2	Main switch relay 1 on
3	Main switch relay 2 off
4	Main switch relay 2 on
5	Mains signal
6	Shunt for appliances
7	Shunt battery
8	Negative Living area battery sensor
9	n. c.
10	+ Living area battery sensor
11	+ Starter battery 12 V
12	+ Lighting

X6	Lumberg MSFQ 10-pin
1	D+
2	Pump
3	Tank heater
4	Anti-freeze
5	n. c.
6	Solar starter battery
7	Solar living area battery
8	n. c.
9	n. c.
10	n. c.
X7	Lumberg MSFQ 2-pin
1	KTY Pin 1
2	KTY Pin 2
X1	Lumberg MSFQ 4-pin
1	ADI1
2	ADI2
3	+12 V
4	GND
X2	Lumberg MSFQ 4-pin
1	ADI1
2	ADI2
3	+12 V
4	GND

9.12.2 Circuit diagram, exterior

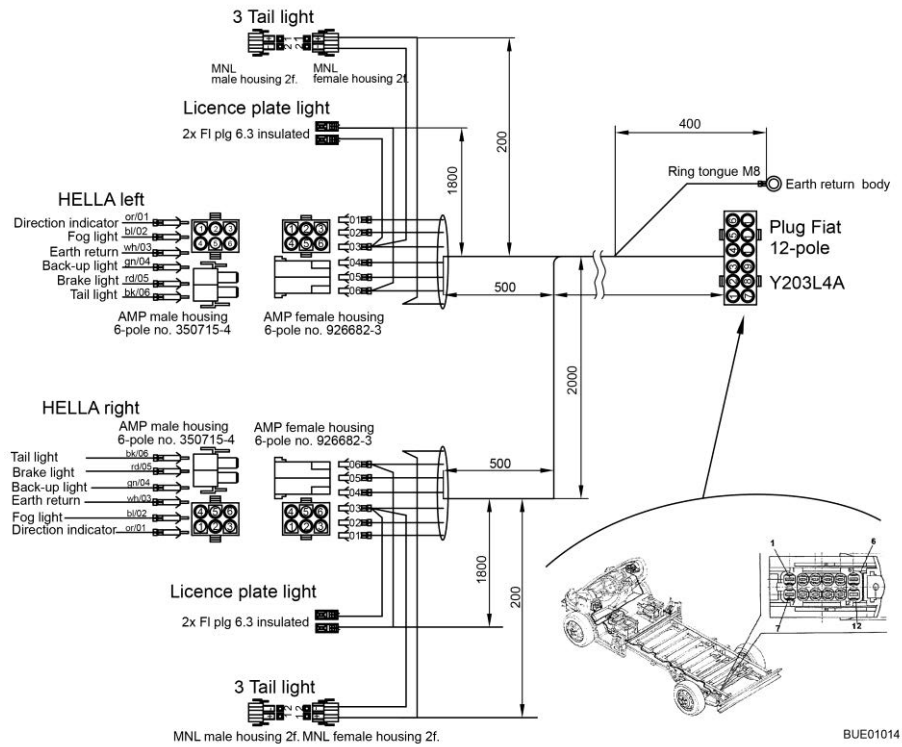

Fig. 155 Circuit diagram, exterior

	Bürstner colours	Connection
Left side	Grey	Left direction indicator
	Blue	Fog tail light
	White	Earth return
	Green	Back-up light
	Red	Brake light
	Black	Left rear light
Right side	Grey	Right direction indicator
	Blue	Fog tail light
	White	Earth return
	Green	Back-up light
	Red	Brake light
	Black	Right rear light

Chapter overview

This chapter contains instructions regarding the appliances of the vehicle.

The instructions refer exclusively to the operation of the appliances.

Further information about the appliances can be found in the instruction manuals for the appliances, included separately with the vehicle.

10.1 General



- ▷ For safety reasons, spare parts for pieces of heating appliances must correspond with manufacturer's instructions and be permitted by the manufacturer as a spare part. These spare parts may only be fitted by the manufacturer or an authorised specialist workshop.



- ▷ Further information can be obtained in the instruction manual for the respective appliance.

The heater, boiler, cooker and refrigerator are fitted depending on the model of the vehicle.

In this instruction manual a description is given only for the operation of the appliances and their particular features.

To operate gas appliances, first open the regulator tap on the gas bottle and the gas isolator tap corresponding to the appliance.

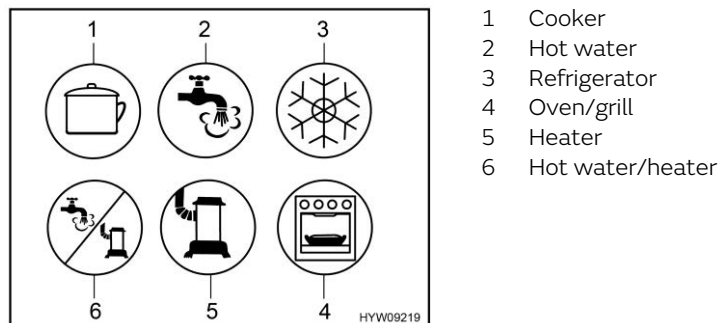

Fig. 156 Possible symbols for the gas isolator taps

10.2 Heater and boiler

The heater can both heat up the vehicle interior (heating the room air) and heat up the domestic water (boiler function). The following instructions are also valid if the heater is only used as boiler.



- ▶ Never let gas escape unburned due to danger of explosion.
- ▶ Never run the heater in gas operation when refuelling, on ferries or in the garage. Danger of explosion!
- ▶ Never operate the heater in gas operation in closed spaces (e.g. garages). Danger of poisoning and suffocation!
- ▶ The waste gas vent may neither be closed nor blocked.
- ▶ Do not use the space behind the heater as a storage space.
- ▶ The water in the boiler can be heated up to 65 °C. Risk of scalding!



- ▷ Hot air may damage the floor covering. Do not point the air outlet nozzles towards the floor covering.
- ▷ Never use boiler when empty.
- ▷ If the boiler is not being used, empty it if there is any risk of frost.
- ▷ Only operate the boiler with the maximum temperature setting if you require a large quantity of warm water. This protects the boiler against the build-up of limescale.



- ▷ Do not use the water from the boiler as drinking water.
- ▷ If the power supply to the heater was interrupted, the time must be re-set.

10.2.1 Models with waste gas vent on the right-hand side of the vehicle



- ▶ If the awning is put up and the heater or the boiler is running in gas operation, exhaust gases from the heater or boiler can escape into the awning area. Danger of suffocation! Make sure the area is sufficiently ventilated.

10.2.2 Alde hot-water heater and boiler



- ▷ Never run hot-water heater without heating fluid. Observe the notes in chapter 13.
- ▷ Never drill holes in the floor. This might damage the hot-water pipes.



- ▷ The circulating pump must always be turned on when the hot-water heater is in operation.
- ▷ We recommend to bleed the heating system after the initial heater operation and to check the glycol content. Observe the notes in chapter 13.
- ▷ When the heater is turned on, it starts with the last settings used.



- ▷ Depending on the equipment, there is an underfloor heater in the driver's cabin.
- ▷ For further information, see the separate manufacturer's instruction manual and observe the maintenance instructions found in chapter 13.

Position See chapter 17.

Operating unit The operating unit is divided into two sections:

- Display (touch screen)
- Operating buttons

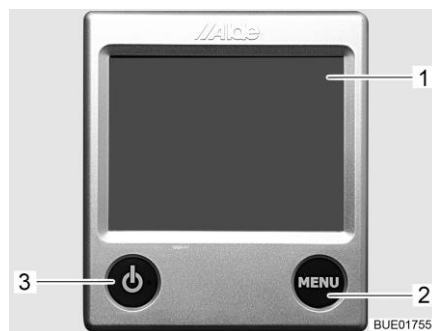

- 1 Display (touch screen)
- 2 "Menu" button
- 3 "On/Off" button

Fig. 157 Operating unit (hot-water heater)



- ▷ When no button is pressed, the operating unit automatically switches to home position after two minutes.
- ▷ Changes to the settings are saved automatically after 10 seconds.

Operating buttons The operating buttons have the following functions:

Pos. in Fig. 157	Button	Function
2	MENU	Open adjustment menu
3		Activate heating

Display The display (Fig. 157,1) is designed as a touch screen. Touching the symbols calls up the relevant function.



Fig. 158 Start screen (operating unit)

Start screen

The start screen appears on the display after the heater is switched on. The start screen contains the following information:

Symbol	Signification
	This symbol appears when the circulating pump is activated
	This symbol appears when the Automatic start function of the heater is activated
	This symbol appears when the daytime automatic mode function is activated
	This symbol appears when the night-time automatic mode function is activated
	This symbol appears when a switching facility for gas bottles is activated
	This symbol appears when a voltage of 230 V is present at the heater
	The internal temperature is displayed next to this symbol
	The external temperature is displayed next to this symbol if an external sensor is fitted







Adjustment menu

The "MENU" button calls up the adjustment menu. The meanings of the individual symbols are described in the following table.



Fig. 159 Adjustment menu (operating unit)

The values can be increased or reduced via the "+" or "-" symbols.

Symbol	Signification
	Setting the desired temperature of +5 to +30 °C
	Setting the water temperature in the boiler
	Setting the heat output in electrical operation
	Heater button in gas operation On/Off
	Tool menu button
	AC button for switching on the automatic air conditioning (only visible when the Truma Aventa air conditioning unit is installed)
	Button for activated functions

Tool menus

The various heater functions can be called up and adjusted via the tool menus. The arrow symbols are used to change between the menus. The meanings of the individual symbols are described in the manufacturer's instruction manual.



Selecting the operating mode

The hot-water heater can be operated with the following energy sources:

- Gas operation
- 230 V electrical operation
- Gas and 230 V electrical operation

The operating mode is selected from the operating unit.

Selecting gas operation:

- Press "" button. The button lights up green. The gas operation is activated.
- Press "" button again. The button lights up blue. The gas operation is switched off.

Selecting 230 V electrical operation:

- Press the "+" button next to the "" symbol until the desired heat output is reached.



- ▷ Select the output level during 230 V electrical operation in such a way that it corresponds to the 230 V connection protection:

Level 1 (1 kW) at 6 A

Level 2 (2 kW) at 10 A

Level 3 (3 kW) at 16 A

Selecting gas and 230 V electrical operation:

- Select gas operation and 230 V electrical operation on the operating unit.



- ▷ If gas and 230 V electrical operation is selected and if the vehicle is connected to the 230 V power supply, then the hot-water heater at first only operates in 230 V electrical operation. Only if the heat output is insufficient does the gas operation also automatically switch on.
- ▷ The gas operation is only possible when the regulator tap on the gas bottle and the gas isolator tap are opened.
- ▷ 230 V electrical operation is only possible when the vehicle is connected to the 230 V power supply.

When the heater is turned on, it starts with the last set operating mode.

Switching on the heater:

- Press "⏻" button. The start screen appears in the display. The heater starts automatically.

Switching off the heater:

- Press "⏻" button. The heater is turned off.

Setting the rotational speed of the circulating pump



- ▷ The hot-water heater is equipped with a very powerful pump. In smaller vehicles, the pump can only be operated at full power if the system is emptied or the pipes are bled. Otherwise, this will increase wear; loud operating noises are the result.



Fig. 160 Speed reduction

The rotational speed of the circulating pump can be set with the control knob (Fig. 160,2). At a lower rotary speed, the operating sounds of the pump are quieter.

The control knob is located on the circulating pump (Fig. 160,1).

Setting the output:

- Turn the control knob (Fig. 160,2) in an anticlockwise direction. The output is reduced.
- Rotate the control knob in a clockwise direction. The output is increased.

3-way valve

For models with a rear bed, a 3-way valve is connected to the hot-water heater circulation. The 3-way valve is installed in the rear garage. The 3-way valve can be accessed via an external flap.

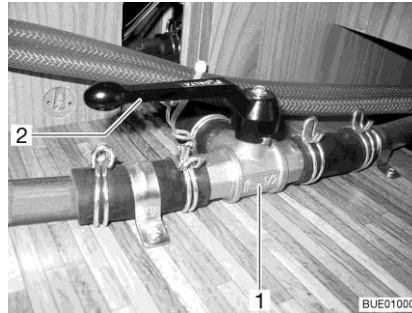

Fig. 161 3-way valve

Opening the heat circulation in the rear area:

- Set the lever (Fig. 161,2) of the 3-way valve (Fig. 161,1) parallel to the straight flow direction (Fig. 161).

Locking the heat circulation in the rear area:

- Set the lever (Fig. 161,2) of the 3-way valve (Fig. 161,1) transverse to the straight flow direction.

Alde heat exchanger (special equipment)



- ▷ The heat exchanger only works when the vehicle engine is running.
- ▷ If the heat exchanger is not being used (as in the summer), the heat exchanger on the stopcock should be shut off.

The heat exchanger can be used to heat the living area of the vehicle during travel without operating the hot-water heater in the living area.

The heat exchanger is connected to the vehicle engine's cooling circuit and thus has the same function as the vehicle heater.

Heat output is set with the living area's heating regulator.

The heat exchanger stopcock is located directly on the exchanger.

Turning on the vehicle heating by heat exchanger:

- Make sure the heat exchanger stopcock is open.
- Press the "⏻" button (Fig. 157,3) on the operating unit (Fig. 157). The start screen appears in the display. That turns on the heating control system and makes the circulating pump run.
- Press "MENU" button (Fig. 157,2).
- Turn off gas operation or 230 V electrical operation (if turned on).
- Set the desired room temperature. To do that, press the "+" or "-" button next to the "🏠" symbol.

Turning off the vehicle heating by heat exchanger:

- Press the "⏻" button (Fig. 157,3) on the operating unit (Fig. 157).



Fig. 162 Alde heat exchanger

- Turning on: ■ Set stopcock handle (Fig. 162,1) parallel to the pipe.
 Turning off: ■ Set stopcock handle (Fig. 162,1) at a right angle to the pipe.

Position The heat exchanger is installed in the rear bench seat of the central seating group.

Alde auxiliary circulating pump (special equipment)



- ▷ The auxiliary circulating pump works only if the heat exchanger has been installed and started, and the hot-water heater is running.

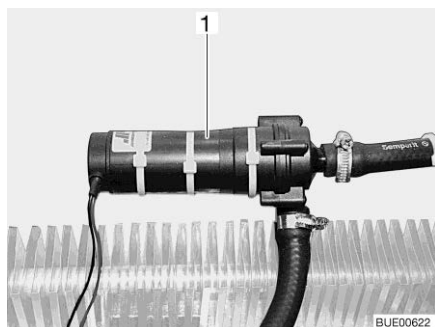

Fig. 163 Auxiliary circulating pump

The auxiliary circulating pump (Fig. 163,1) can be used to heat the vehicle engine when parked.

The auxiliary circulating pump is connected to the vehicle engine's cooling circuit and thus functions as an engine heater.



Fig. 164 Operating switch for auxiliary circulating pump

The auxiliary circulating pump switch (Fig. 164) is located next to the hot-water heater operating unit. The yellow indicator lamp illuminates when the pump is operated.

Filling/emptying the boiler

The boiler can be supplied with water from the water tank.



- ▷ Depending on the model, the vehicle is fitted with one or two drain cocks.

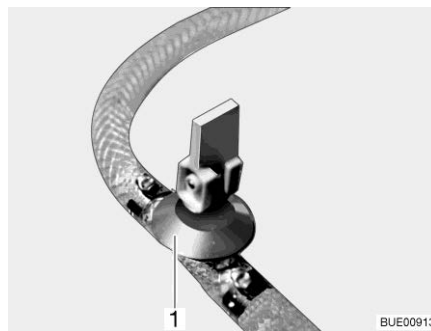

Fig. 165 Drain cock

Filling the boiler with water:

- Close the drain cock(s). Position the rocking lever (Fig. 165,1) horizontally.
- Switch on the 12 V power supply on the panel.
- Set all the water taps to "Hot" and open them. The water pump is turned on. The warm water pipes are filled with water.
- Keep the water taps open until the water flowing out of the water taps has no bubbles in it. This is the only way to ensure that the boiler is full of water.
- Close all water taps.

Emptying the boiler:

- Switch off the boiler.
- Open all water taps and set to the central position.
- Open drain cock(s) (Fig. 165). To do so, set the rocking lever (Fig. 165,1) in a vertical position. The boiler is drained to the outside.
- Check whether the water has been drained completely from the boiler (approx. 10 litres).



Position of the drain cock(s)

- ▷ For further information, see the separate manufacturer's instruction manual and observe the maintenance instructions found in chapter 13.

See chapter 17.

10.2.3 Wall flue

Fresh air and exhaust gases of the heater system are conducted in a two-chamber wall flue.



- ▷ Park the vehicle such that the wall flue gets enough fresh air.
- ▷ The wall flue must be free at all times. Do not cover the wall flue.
- ▷ When camping in winter, maintain wall flue free of snow and ice.
- ▷ Check the wall flue periodically depending on the weather (snow, leaf fall, dirt, etc.). If necessary, clean the wall flue.
- ▷ When washing the vehicle do not aim the water jet directly at the wall flue.
- ▷ When disregarding this, the flawless operation of the heater can not be guaranteed.



Fig. 166 Wall flue (hot-water heater)

The wall flue is mounted on the left side wall.

Flue shield

If the wall flue is installed above the service flap, condensation may drip on the gasket of the service flap. Use the flue shield to protect the gasket from condensation.



Fig. 167 Flue shield

Installing the flue shield:

- Push the flue shield (Fig. 167,1) in from below, between the wall flue and the wall, until it engages in the fastening screws of the wall flue.



- ▷ If a flue shield (Fig. 167,1) is installed on the wall flue: Remove flue shield before setting off.

10.2.4 Electrical floor warming unit (special equipment)

- ▶ On models with electrical floor warming unit, never drill holes in the floor or screw in any screws. Careful with sharp objects. There is danger of a power cut or a short circuit due to damage to a heater wire.



- ▷ Do not cover the transformer. Danger of overheating!



- ▷ The electrical floor warming unit only operates if the vehicle is connected to the 230 V power supply.
- ▷ The output of the electrical floor warming unit alone is not sufficient to heat the living area.



Fig. 168 Transformer for electrical floor warming unit

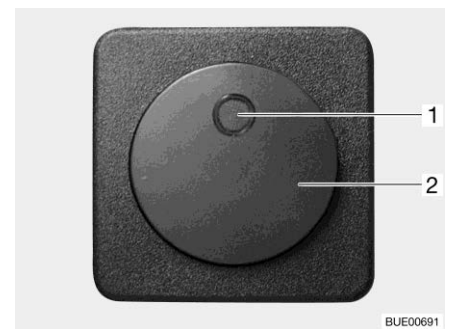

Fig. 169 Switch for electrical floor warming unit

The transformer for the electrical floor warming unit is installed either in the bench seat, in the bedding box or in the rear garage, depending on the model.

- Switching on:**
- Connect the vehicle to the 230 V power supply (see chapter 9).
 - Press the rocker switch (Fig. 169,2). The indicator lamp (Fig. 169,1) on the switch is illuminated.

- Switching off:**
- Press the rocker switch (Fig. 169,2). The indicator lamp (Fig. 169,1) on the switch goes off.

After switching off, the floor remains warm for a while, due to residual heat. If the transformer (Fig. 168,1) is overloaded, the overload protection is actuated. The pin (Fig. 168,2) jumps out.

- Switching on overload protection:**
- Press the pin (Fig. 168,2) on the overload protection when the transformer is cooled.

10.3 Air conditioning unit (special equipment)

10.3.1 Truma Aventa air conditioning unit



- ▷ The cooling circuit may only be opened by the manufacturer or an authorised specialist workshop.
- ▷ Do not block the air inlets and air outlets.
- ▷ Do not drive on any gradients or inclines greater than 8 % when the air conditioning unit is in operation. Otherwise the compressor could be damaged.
- ▷ Do not operate the unit in cooling mode for extended periods when the vehicle is on an incline. Condensation can enter the interior.



- ▷ The air conditioning unit only runs if the vehicle is connected to a 230 V power supply.
- ▷ The external 230 V power supply must be protected by a fuse of at least 6 A. It is otherwise not possible to operate the air conditioning unit properly.
- ▷ Heating at external temperatures below 4 °C is not possible, as the heating output then falls sharply. The unit switches to defrosting for a short time at temperatures between 4 °C and 7 °C. Unrestricted heating operation is possible at external temperatures above 7 °C.
- ▷ Always point the remote control at the infrared receiver when using it.
- ▷ Also read the manufacturer's instruction manual.

Operating modes The air conditioning unit can be operated in the following modes:

- Automatic
- Cooling
- Heater
- Air circulation

Remote control All functions of the air conditioning unit can be operated via the remote control.

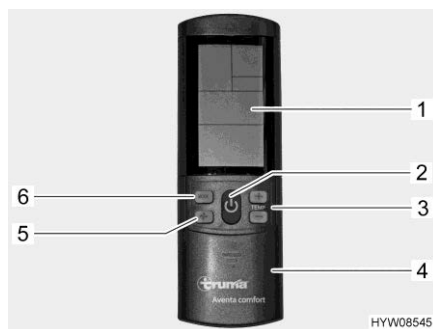

- 1 Display
- 2 On/Off button
- 3 Buttons "+" and "-" for temperature selection
- 4 Sliding door for field with setting buttons
- 5 Fan setting selection button (three levels)
- 6 Mode selection button

Fig. 170 Remote control (air conditioning unit)

Automatic mode

In automatic mode the desired temperature merely has to be set.

Depending on the room temperature, the air conditioning unit automatically selects cooling or heating mode and the fan setting.

- Switching on:**
- Press the On/Off button (Fig. 170,2). The last settings selected are accepted.



- ▷ The circulation fan runs after switching on. The compressor switches itself on after no more than 3 minutes. The blue LED (cooling) or the yellow LED (heating) flashes.

- Use the "+" and "-" buttons (Fig. 170,3) to set the desired temperature.

- Switching off:**
- Press the On/Off button (Fig. 170,2). The lighting can continue to be operated.

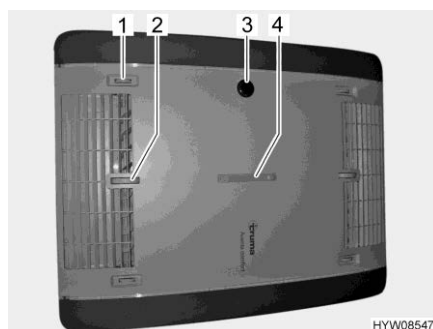

- 1 Air distribution right/left
- 2 Air distribution ceiling/floor
- 3 IR receiver, function display, manual on/off
- 4 Air distribution front/rear

Fig. 171 Function display and air distribution (air conditioning unit)

Operation and display on the unit

Certain functions can be operated directly on the unit.

- Air distribution adjustment:**
- Set the small adjustment wheel and sliding regulator for stepless air distribution as desired.

- Switching on/off manually:**
- Press the micro button (e.g. with a ballpoint pen if the remote control is not in reach).

Function display

Status LED	Signification
Blue LED flashes	Compressor starts up (cooling mode)
Blue LED lights up	Cooling operation
Yellow LED flashes	Compressor starts up (heating mode)
Yellow LED lights up	Heating mode
Red LED flashes	Data is transferred
Red LED lights up	Fault

Manual mode

In the manual mode, the cooling, heater, and air circulation can be set separately on the remote control.

Switching on the cooling:

- Press the On/Off button (Fig. 170,2).
- Press the mode selection button (Fig. 170,6) until the cooling symbol appears in the display (Fig. 170,1).
- Use the "+" and "-" buttons (Fig. 170,3) to set the desired temperature.
- Use the "🌀" selection button (Fig. 170,5) to set the desired fan level.

When the room temperature set on the remote control is reached, the compressor switches itself off and the blue LED in the IR receiver goes out. The circulation fan continues to run.

When the room temperature rises above the set temperature, the unit automatically switches itself back to cooling mode.

Switching on the heater:

- Press the On/Off button (Fig. 170,2).
- Press the mode selection button (Fig. 170,6) until the heating symbol appears in the display (Fig. 170,1).
- Use the "+" and "-" buttons (Fig. 170,3) to set the desired temperature.
- Use the "🌀" selection button (Fig. 170,5) to set the desired fan level.

When the room temperature set on the remote control is reached, the compressor switches itself off and the yellow LED in the IR receiver goes out. The circulation fan continues to run.

When the room temperature falls below the set temperature, the unit automatically switches itself back to heating mode.

Switching on air circulation:

- Press the On/Off button (Fig. 170,2).
- Press the mode selection button (Fig. 170,6) until the air circulation symbol appears in the display (Fig. 170,1).
- Use the "+" and "-" buttons (Fig. 170,3) to set the desired temperature.
- Use the "🌀" selection button (Fig. 170,5) to set the desired fan level.

In air circulation mode, the inside air is circulated and is cleaned by the filter. No LEDs light up in the IR receiver.

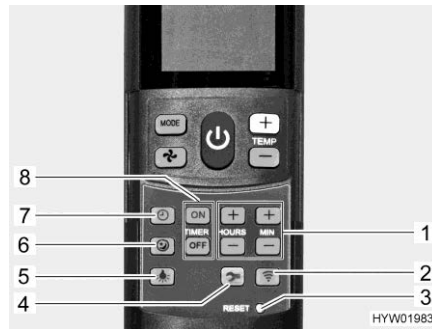

Fig. 172 Remote control with setting buttons (air conditioning unit)

- 1 Buttons for setting the time and the timer
- 2 Send button (repeat data transfer)
- 3 Micro button "RESET" (resetting to the factory setting)
- 4 Setup button for start-up
- 5 Light button (for operating the lighting)
- 6 Soft-start button (for quiet cooling operation)
- 7 Time button (for setting the time)
- 8 "TIMER" buttons for switching time preselection on/off

Activating soft-start: ■ Press the soft-start button (Fig. 172,6). The fan then runs at low speed in cooling mode, which makes it especially quiet.

Setting the time: ■ Press the time button (Fig. 172,7).
 ■ Set the hours and minutes with the buttons (Fig. 172,1).

Switching on the timer: ■ Press the On/Off button (Fig. 170,2).
 ■ Set the desired mode and temperature.

Programming the switching on time: ■ Press "ON" button (Fig. 172,8).
 ■ Press the buttons for setting the time (Fig. 172,1) until the desired time span until switch-on is reached.
 ■ Press "ON" button (Fig. 172,8).

Programming the switch-off time: ■ Press "OFF" button (Fig. 172,8).
 ■ Press the buttons for setting the time (Fig. 172,1) until the desired time span until switch-off is reached.
 ■ Press "OFF" button (Fig. 172,8).

Deactivating the timer: ■ Press the "ON" or "OFF" button (Fig. 172,8) again.

The integrated timer enables the switch-on/switch-off time for the air conditioning unit to be set between 15 minutes and 24 hours in advance (calculated from the current time).

Switching on the lighting: ■ Press the light button (Fig. 172,5). The light is switched on at the last set dimming level.

Dimming the lighting: ■ Press the light button (Fig. 172,5) and keep it pressed until the desired brightness is reached.

Switching off the lighting: ■ Press the light button (Fig. 172,5).



- ▷ The Setup button (Fig. 172,4) is used to connect the remote control with the air conditioning unit during first set-up.
- ▷ Further information can be obtained in the manufacturer's instruction manual.

10.3.2 Telair



▷ Always wait at least 2 minutes between switching off and switching on again. Otherwise the compressor will be damaged.

▷ If the unit is operating, always open at least one ventilation flap.



▷ The air conditioning unit only runs if the vehicle is connected to a 230 V power supply.

▷ In the winter, vehicle heating can be supported but not replaced by the air conditioning unit.

▷ Following switch-on the air conditioning unit needs approx. 3 minutes until the compressor starts to run and cold air or hot air is output.

▷ Also read the manufacturer's instruction manual.

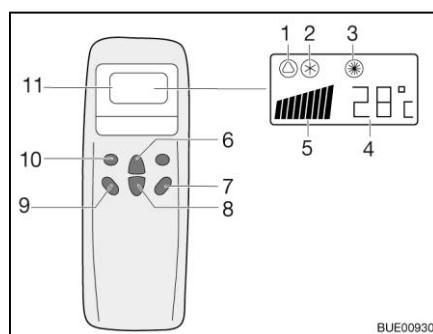

- 1 Symbol for automatic
- 2 Symbol for cooling
- 3 Symbol for heater
- 4 Temperature (set) display
- 5 Fan speed display
- 6 Temperature increase button
- 7 "ON/OFF" button
- 8 Temperature reduction button
- 9 Ventilation speed button
- 10 "Mode" button
- 11 Display

Fig. 173 Remote control

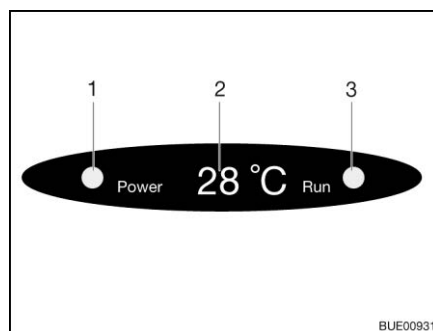

- 1 Mains connection indicator lamp
- 2 Temperature (current) display
- 3 Operating mode indicator lamp
green: cooling
red: heater

Fig. 174 Display on the diffuser

To execute the individual switching commands, always point the remote control in the direction of the receiver.

Operating modes

- Automatic
- Cooling
- Heater

Switching on:

- Press the "ON/OFF" button (Fig. 173,7).
- Press the "Mode" button (Fig. 173,10) as often as required until the required operating mode (Fig. 173,1, 2 or 3) is indicated on the display. The corresponding indicator lamp on the diffuser display (Fig. 174,3) lights up.

- Use the temperature increase button (Fig. 173,6) or temperature reduction button (Fig. 173,8) to set the required temperature.
- Use the ventilation speed button (Fig. 173,9) to select the required ventilation level.

Switching off:



- Press the "ON/OFF" button (Fig. 173,7).
- ▷ If the air conditioning unit has run in heating mode, the blower will run on for some minutes in order to dissipate the heat completely.

10.4 Cooker



- ▶ During operation of the gas cooker, do not leave the gas cooker unattended. Even if the gas cooker cannot be overseen for only a short time (e.g. Visit to the toilet), switch the gas cooker off.
- ▶ Never let gas escape unburned due to danger of explosion.
- ▶ Before using the cooker make sure that there is sufficient ventilation. Open a window or the skylight.
- ▶ Do not use gas-operated cooking and baking facilities for heating purposes.
- ▶ Always protect your hands with cooking gloves or potholders when handling hot pots, pans and similar items. There is a risk of injury!
- ▶ Do not fit any curtains in the immediate proximity of the cooker. Fire hazard!



- ▷ Do not place any hot objects such as cooking pans neither on the sink cover nor on the gas cooker cover nor on the work top.

10.4.1 Gas cooker



- ▶ During activation and operation of the gas cooker, no flammable objects or highly inflammable objects such as dishcloths, napkins etc. must be near the gas cooker. Fire hazard!
- ▶ The process of ignition must be visible from above and must not be covered by cooking pans placed on the cooker.
- ▶ If there is a flame protection, always put it up when using the gas cooker. Before driving, remove the flame protection and store it safely.
- ▶ The gas cooker cover is held closed by a spring. When closing there is danger of getting injured!



- ▷ Do not use the glass gas cooker cover as a hob.
- ▷ Do not close the gas cooker cover while the gas cooker is in operation.
- ▷ Do not apply pressure on the gas cooker cover when it is closed.
- ▷ Keep the gas cooker cover open after cooking until the burners are cool. Otherwise the glass plate could shatter.



- ▷ Only use pots and pans whose diameter is appropriate for the gas cooker burners.
- ▷ When the flame goes out, the thermocouple automatically cuts the gas supply.
- ▷ Further information can be obtained in the manufacturer's instruction manual.

The vehicle kitchen unit is fitted with a three-burner gas cooker.

Automatic ignition (with lighting knob)

The gas cooker is equipped with electronic ignition.

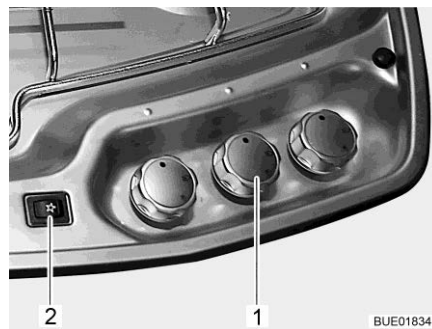

Fig. 175 Operating controls for gas cooker

- Switching on:**
- Open the regulator tap on the gas bottle and the gas isolator tap "Cooker".
 - Open the gas cooker cover.
 - Depending on the model, fold out and lock the flame protection.
 - Turn the control knob (Fig. 175,1) on the burner you wish to use to the ignition position (large flame).
 - Press the control knob down and hold it.
 - Press lighting knob (Fig. 175,2). Ignition sparks are generated at the burner.
 - Once the flame is burning, the control knob must be held down for another 10 to 15 seconds, until the thermocouple automatically keeps the gas supply open.
 - Release the control knob and turn to the desired setting.
- Switching off:**
- Turn the control knob to the 0 position. The flame fades.
 - Close the gas isolator tap "Cooker" and the regulator tap on the gas bottle.

10.4.2 Gas oven (Dometic) (special equipment)



- ▶ Keep the ventilation openings on the gas oven open at all times.
- ▶ There must be no flammable or highly inflammable objects such as dishcloths, clothes, etc. near the gas oven when it is being lit or during operation. Fire hazard!
- ▶ If ignition has not taken place, repeat the entire procedure. If necessary, check if there is gas and/or current in the gas oven.
- ▶ If the gas oven still does not work, close the gas isolator tap and notify your service centre.
- ▶ If the burner flame is accidentally extinguished, turn the control knob to "O" and leave the burner off for at least 1 minute. Then ignite it again.
- ▶ Parts of the gas oven become very hot during operation. Never touch hot parts with bare hands.
- ▶ Place the meals, wire rack and drip pan into the gas oven so that they do not come into contact with the flame.
- ▶ Only ignite the oven when the oven door is open.
- ▶ If the oven is installed into the bottom cupboard: Attach heat protection sheet to the ventilation grill. Otherwise, the drawer's handle may heat up considerably.



- ▷ There are two different versions of the gas oven, depending on the model. Although their appearance is not identical, operation is the same for both.
- ▷ Before using the gas oven for the first time run it for 30 minutes at maximum temperature without any contents.
- ▷ When the flame goes out, the thermocouple automatically cuts the gas supply.
- ▷ A safety switch prevents ignition when the oven door is closed.
- ▷ If the ignition procedure fails repeatedly, turn the control knob to "O". Wait at least 1 minute and then ignite the gas oven manually. If necessary, check if there is gas and/or current in the gas oven. If the gas oven still does not work, close the gas isolator tap and notify your service centre.
- ▷ Further information can be obtained in the manufacturer's instruction manual.



Fig. 176 Heat protection sheet (loose)

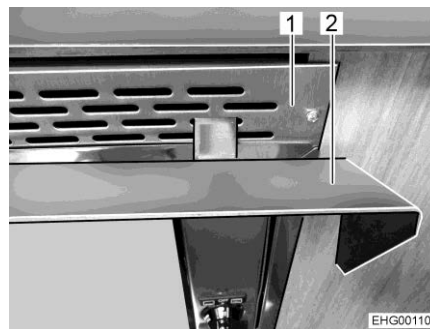

Fig. 177 Heat protection sheet (hooked in)

Hooking in the heat protection sheet:

- Hook heat protection sheet (Fig. 176,1 and Fig. 177,2) into the ventilation grill (Fig. 177,1) of the oven.



The gas oven is equipped with electronic ignition.



Fig. 178 Gas oven (Dometic Tec-Tower)



Fig. 179 Gas oven (Dometic)

The meaning of the symbols on the control knobs (Fig. 178,1 and Fig. 179,1) of the two gas ovens is identical:  and  stand for the oven.

Switching on the oven:

- Open the regulator tap on the gas bottle and the gas isolator tap "Oven".
- Open oven door completely. The safety switch then releases the ignition.
- Press and hold control knob and turn it anti-clockwise to the required setting. Keep control knob pressed for a further 5-10 seconds. Ignition will take place automatically.
- Release control knob.
- Close oven door.

Switching off the oven:

- Turn the control knob to "O". The flame fades.
- Close the gas isolator tap "Oven" and the regulator tap on the gas bottle.

10.4.3 Microwave oven (special equipment)



- ▶ Only qualified personnel may repair the microwave oven. Improper repairs can cause major risks to the user.
- ▶ The protection device against the escape of microwave energy should never be removed.
- ▶ Use the microwave oven only if it has been properly installed.
- ▶ Only use the microwave oven when the door seal is free of damage.
- ▶ Never leave the microwave oven unattended when it is in operation.
- ▶ If there is smoke, keep the microwave oven closed, switch it off and interrupt the power supply.



- ▷ Operate the microwave oven only with the rotary plate and the rotary cross in place.
- ▷ Use only crockery suitable for microwave use.
- ▷ Only operate the microwave with appropriate contents and never run it empty.



- ▷ For cooking times under 2 minutes: First twist the cooking time control knob past "2" and then twist it back to the desired cooking time.
- ▷ Further information can be obtained in the manufacturer's instruction manual.

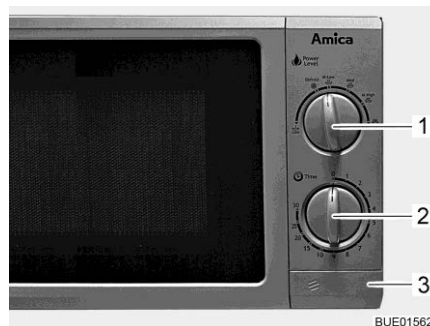

Fig. 180 Operating controls (microwave oven)

- Switching on:**
- Press the key (Fig. 180,3) to open the door and place food into the cooking area.
 - Close the door. A clicking noise can be heard when it engages.
 - Select the output on the control knob (Fig. 180,1).
 - Select the cooking time with the control knob (Fig. 180,2). Cooking begins.

The end of the cooking process is signaled by a signal tone. The microwave oven will switch off automatically.

- Switching off:**
- Press the key (Fig. 180,3) to open the door and take out the food.

10.4.4 Extractor hood (special equipment)

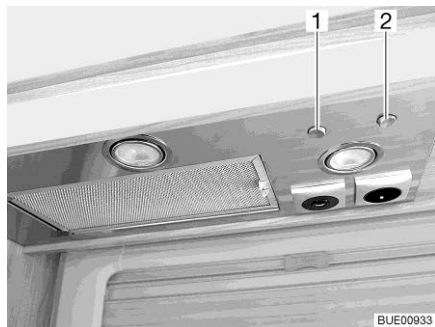

Fig. 181 Extractor hood

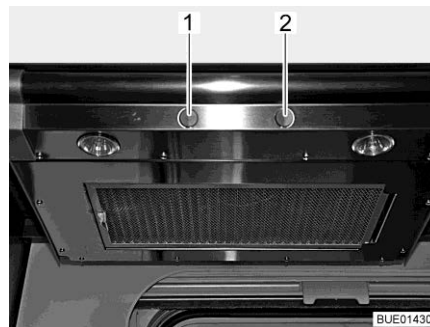

Fig. 182 Extractor hood (alternative)

The cooking area is equipped with an extractor hood. The powerful fan blows the cooking steam directly outside. To switch on the extractor hood, press the right flip switch (Fig. 181,2 or Fig. 182,2).

Use the left flip switch (Fig. 181,1 or Fig. 182,1) to switch on the two lights in the extractor hood.

10.5 Refrigerator

During the journey, only operate the refrigerator via the 12 V power supply. At high ambient temperatures the refrigerator is unable to reach its full cooling power.



- ▷ When leaving the vehicle, always mount the refrigerator ventilation grill. Otherwise water can enter during rain.
- ▷ The cooling power of the refrigerator depends on the vehicle setup. The cooling power can decrease if the vehicle is inclined by 5° or more. Therefore, always park the vehicle on level ground.
- ▷ Absorption refrigerators operate at normal room temperature (approx. 21 °C) within the specified temperature range. At significantly higher ambient temperatures (> 30 °C), the cooling power is reduced.

10.5.1 Refrigerator ventilation grill

At high external temperatures, the full cooling power of the cooling unit is only guaranteed if the refrigerator is ventilated sufficiently. In order to achieve a better ventilation the refrigerator ventilation grill can be removed.

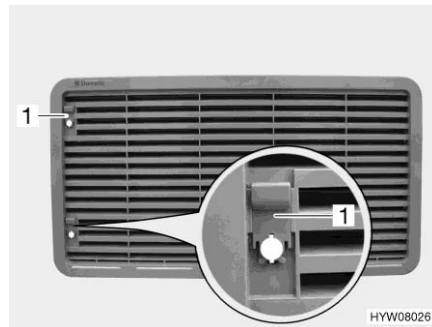

Fig. 183 Refrigerator ventilation grill
(with sliding trap)



Fig. 184 Refrigerator ventilation grill
(with screw)

- Removing:**
- Depending on version: Push up the sliding trap (Fig. 183,1) or turn the screw (Fig. 184,1) a quarter turn using a coin.
 - Remove refrigerator ventilation grill.

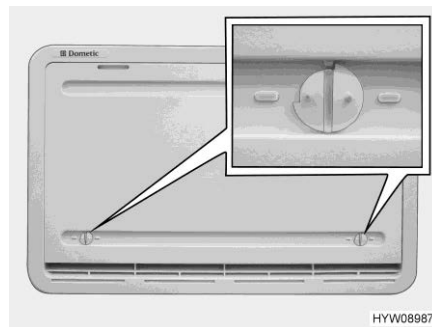

Fig. 185 Winter cover

Winter cover If the refrigerator is to be operated at low external temperatures, the manufacturer recommends the use of a winter cover (Fig. 185) for the refrigerator ventilation grills.

The table below shows the temperature ranges in which the winter cover or the insulated winter cover may be used.

Temperature	Cover
Below 10 °C	Winter cover (for refrigerators with capacity below 130 litres: fit only on the lower ventilation grill)
Below -5 °C	Insulated winter cover (fit only on the lower ventilation grill)



- ▷ If the temperatures are higher than the indicated values, it is absolutely necessary to remove the winter cover. Otherwise the vehicle could be damaged.

- Mounting:**
- Open both locks (Fig. 185) (groove in horizontal position).
 - Put winter cover in front of the ventilation grill.
 - Lock the locks with a small coin (groove in vertical position).

- Removing:**
- Open both locks (Fig. 185) (groove in horizontal position).
 - Remove winter cover from ventilation grill.



- ▷ The winter cover may remain mounted during the journey.

10.5.2 Dometic MES/AES

Depending on the equipment, different versions of the refrigerator will be installed.

Version MES Manual power selection, automatic ignition

Version AES Automatic and manual power selection, automatic ignition

Operating modes The refrigerator has 3 operating modes:

- 230 V operation
- 12 V operation
- Gas operation



- ▷ The refrigerator always requires a 12 V control voltage, regardless of which type of energy it is using. The control voltage is present as soon as the transformer/rectifier is switched on. Therefore the closed circuit current always flows even if the refrigerator is switched off. Always switch off the transformer/rectifier for a temporary lay-up.
- ▷ Close the gas isolator tap "Refrigerator" when the refrigerator is operated electrically.

230 V operation The refrigerator is operated via an external power supply.

12 V operation The refrigerator is operated via the vehicle battery.



- ▷ If the vehicle engine is not running and the refrigerator is manually switched to 12 V operation, the living area battery drains very quickly.



- ▷ In the automatic mode (only AES version), the 12 V operation is only selected, when the vehicle engine is running.

Gas operation The refrigerator is operated with gas from a connected gas bottle.



- ▷ If LPG is used, the gas burner must be cleaned more frequently.

Change-over between energy sources

During change-over between the different energy sources, intended delays are installed in the automatic mode (only AES version). This means, that after a change-over to a new energy source the refrigerator can not be operated immediately. When changing from 12 Volt operation to gas operation, the delay is 15 minutes. This prevents a change-over to gas operation when the vehicle is stopped briefly (e.g. stop to fill tank).

Stop to fill tank

- ▶ Open flames are prohibited at petrol stations.

If the refrigerator was manually set for gas operation during the journey: Switch off the refrigerator in the petrol station area or change over to 12 V operation.

If the refrigerator was operated in the automatic mode during the journey (only in the case of the AES version) and the stop for filling the tank takes longer than 15 minutes: switch off the refrigerator. Otherwise, the AES will automatically change over to gas operation 15 minutes after stopping the vehicle engine.

Ignition fuse

When selecting gas operation the ignition fuse is opened automatically so gas can get into the burner. At the same time the electronic ignition is activated. If the gas flame is extinguished, e.g. by blast of wind, the ignition is activated immediately and re-ignites the gas. If there is a fault in gas operation, the illuminated buttons for Gas (Fig. 186,3) and Fault (Fig. 186,9) flash and an alarm sounds for 20 seconds.

Operation

Fig. 186 LED operating panel (Dometic refrigerator)

- 1 On/Off button
- 2 Illuminated button for 230 V mode
- 3 Illuminated button for Gas mode
- 4 Illuminated button for 12 V mode
- 5 Illuminated button for AES operating mode (depending on the model)
- 6 Illuminated button for frame heater (depending on the model)
- 7 Cooling level button
- 8 Cooling level indicator
- 9 Illuminated button for Fault/Reset in gas mode

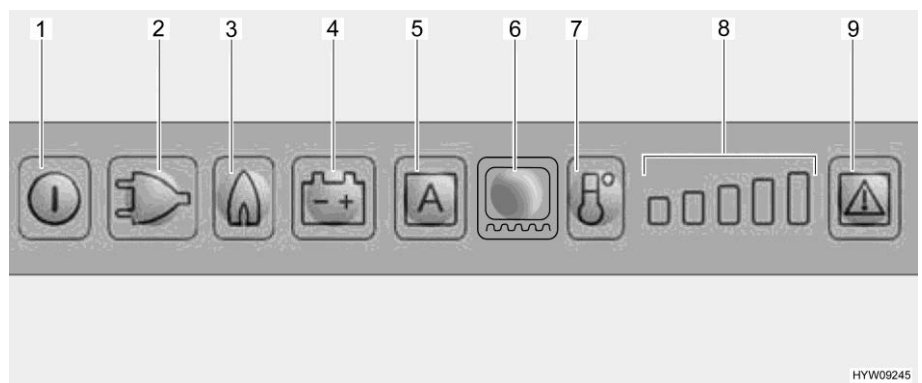

- ▷ If the refrigerator shall be operated with gas: Open the regulator tap on the gas bottle and the gas isolator tap "Refrigerator".

Switching on:

- Press and hold the On/Off button (Fig. 186,1) for about 2 seconds. The refrigerator switches on and the previously set operating mode is displayed.

- Selecting operating mode:**
- Press the illuminated button for the desired operating mode (Fig. 186,2 - 4) or the automatic mode "AES" (Fig. 186,5) (only in the case of AES version).

In the case of the AES version, the automatic energy selection is carried out in the following order as a function of the availability of the energy sources:

- 12 V solar (special equipment)
- 230 V AC
- 12 V DC
- Gas

- Setting the refrigerating temperature:**
- Use the cooling level button (Fig. 186,7) to set the refrigerating temperature. The cooling level indicator (Fig. 186,8) shows the selected thermostat setting.

- Switching off:**
- Press and hold the On/Off button (Fig. 186,1) for about 2 seconds.
 - If the refrigerator had been operated with gas: Close the gas isolator tap "Refrigerator" and the regulator tap on the gas bottle.

Refrigerating temperature control

When turned on the first time the refrigerator automatically selects the middle thermostat position. This position can be adjusted manually using the cooling level button (Fig. 186,7). It takes a few hours till the refrigerator reaches its normal operating temperature. When changing over to another operating mode, the thermostat setting is kept.

Frame heater (depending on the model)

High external temperatures and high humidity can cause drops of water to form on the metal frame of the freezer compartment. To prevent any possible corrosion, the freezer compartment is equipped with a frame heater.



- ▷ When the frame heater is turned on, it uses about 4 Watts, including in gas operation. To avoid running down the living area battery, in gas operation refrain from running the frame heater in continuous operation or turn the frame heater off entirely.

The following options are available for operating times of the frame heater:

- 2 hours
- 5 hours
- Continuous operation (switched on for 30 minutes, then for 5 minutes on and 5 minutes off in alternating intervals)

- Setting operating time:**
- Switch on the frame heater for a 2 hour period: Push the frame heater illuminated button (Fig. 186,6) once. One bar is lit on the cooling level indicator (Fig. 186,8).
 - Switch on the frame heater for a 5 hour period: Push the frame heater illuminated button (Fig. 186,6) twice. Two bars are lit on the cooling level indicator (Fig. 186,8).
 - Setting frame heater for continuous operation: Push the frame heater illuminated button (Fig. 186,6) three times. Three bars are lit on the cooling level indicator (Fig. 186,8).

The cooling level indicator (Fig. 186,8) shows the operating time of the frame heater for several seconds.

Additional functions

If, after switching on or after setting, no further button is pressed, the brightness of the display is reduced after a few seconds. When pressing a button, the display will light up again. By pressing again, the desired function is activated.

In the automatic mode (only AES version), "AES" and the type of energy currently in use are displayed.

If the refrigerator door remains open for more than 2 minutes, a warning signal sounds.

In the event of a fault, the illuminated Fault button (Fig. 186,9) will flash. Also, either one of the illuminated buttons for operating mode or the cooling level indicator will flash. In addition, a warning signal will sound. For instructions on the display of errors and troubleshooting, see chapter 15.



- ▷ After eliminating a fault of the gas operation, press the illuminated Reset button (Fig. 186,9).
- ▷ Further information can be obtained from the separate instruction manual "Refrigerator".

10.5.3 Refrigerator door locking mechanism

With some models, the refrigerator has a separate freezer compartment. The specifications in this section correspondingly also apply to the door of the freezer compartment.



- ▷ During the journey the refrigerator door must always be closed and locked in the closed position.



- ▷ Lock the refrigerator door in ventilation position when the refrigerator is switched off. This prevents mould forming.

There are two positions for locking the refrigerator door in place:

- Closed refrigerator door during travel and when the refrigerator is in operation
- Slightly opened refrigerator door as a ventilation position when the refrigerator is switched off

Dometic 8 series

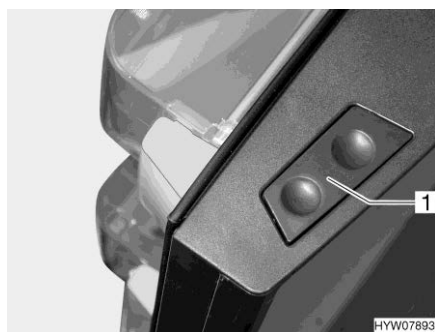

Fig. 187 Release button (refrigerator door, Dometic 8 series)

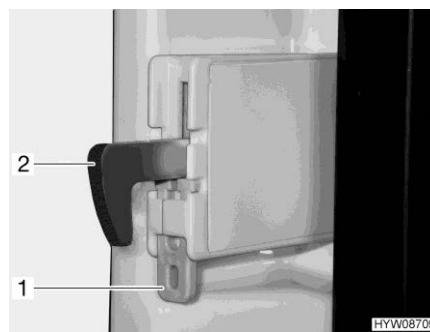

Fig. 188 Fixture (lock hook)

Opening: ■ Press the release button (Fig. 187,1) and open the refrigerator door.

Closing: ■ Close the refrigerator door. The lock hook engages audibly.

When the vehicle has been positioned, the lock hook can be fixed. The refrigerator door can now be opened without having to press the release button.

Fixing the lock hook: ■ Press the fixture (Fig. 188,1) upwards. The lock hook (Fig. 188,2) is pressed upwards and has no function.

Unlocking the lock hook: ■ Push the lock hook (Fig. 188,2) down. The lock hook functions again.

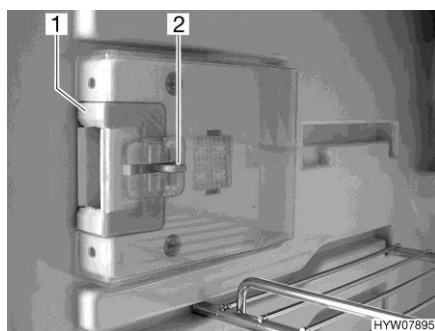

Fig. 189 Locking device (normal position)

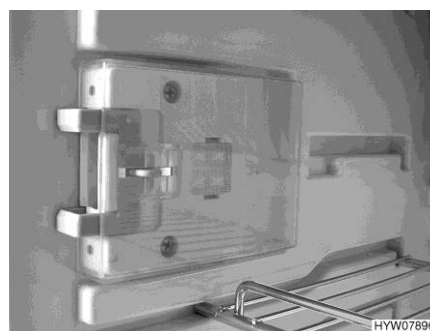

Fig. 190 Locking device (ventilation position)

Locking in the ventilation position:

- Open the refrigerator door.
- Press down the unlocking device (Fig. 189,2).
- Push locking device (Fig. 189,1) forwards (Fig. 190).

If the refrigerator door is closed now, a gap will remain between the refrigerator door and the refrigerator.

Chapter overview

This chapter contains instructions regarding the sanitary fittings of the vehicle.

11.1 Water supply, general



- ▶ Fill water tank from supply systems that have been verified to provide drinking water quality.
- ▶ Only use such hoses or containers when filling that have been approved for use with drinking water.
- ▶ Thoroughly rinse filling hose or container with drinking water before use (2 to 3 times capacity).
- ▶ Empty filling hose or container completely after use and close openings of the filling hose or container.
- ▶ Water left standing in the water tank or in the water pipes becomes undrinkable after a short period. Therefore, before each use of the vehicle, thoroughly clean the water pipes and the water tank. After each use of the vehicle completely empty the water tank and the water pipes.
- ▶ In the case of lay-ups lasting more than a week disinfect the water system before using the vehicle (see chapter 12).



- ▷ If the vehicle is not used for several days or if it is not heated when there is a risk of frost, empty the entire water system. Make certain that the water pump is switched off on the panel. Otherwise, the water pump will overheat and may get damaged. Leave the water taps on in central position. Leave all drain cocks open. Frost damage to appliances, frost damage to the vehicle and deposits in water-carrying components can be avoided in this way.
- ▷ The water pump will overheat without water and can get damaged after one minute at the latest. Never operate water pump when the water tank is empty.

The vehicle is equipped with a fitted water tank. An electric water pump pumps the water to the individual water taps. Opening a water tap automatically switches on the water pump and pumps water to the tap.

The waste water tank collects the waste water. On the panel you can check how full the waste water tank is.



- ▷ Before the water fittings can be used, the 12 V power supply on the panel must be switched on. Otherwise the water pump will not work.
- ▷ When the water tank is re-filled, an air bubble may form at the bottom of the pump. This air bubble will prevent water from being drawn in. Shake the water pump up and down energetically in the water.

11.2 Water system

11.2.1 Water tank



- ▷ The water tank holds approx. 140 l. However the volume has been limited to 20 litres (overflow installed) for payload reasons. The panel has not been adjusted to this volume. The level indicator on the panel shows the actual amount of water in the tank.

If necessary or if there is a sufficiently large residual vehicle payload, the water tank can be filled up to its actual capacity. To do this, close overflow. The rotary handle is on the water tank.

11.2.2 Drinking water filler neck with cap

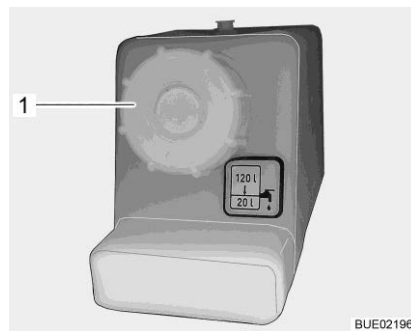

Fig. 191 Cap for the drinking water filler neck

The drinking water filler neck is located in the service unit.

- Opening:**
- Open the service unit flap.
 - Turn the cap (Fig. 191,1) anticlockwise and remove.
- Closing:**
- Place the cap onto the drinking water filler neck and turn it clockwise.
 - Close the service unit flap.

11.2.3 Filling the water system



- ▶ When filling the water tank, observe the maximum permissible gross weight of the vehicle. Luggage must be reduced accordingly when the water tank is full.



- ▷ The water pump will overheat without water and can get damaged. Never operate water pump when the water tank is empty.



- ▷ Depending on the model, the Alde system (heater/boiler) has one or two drain cocks for emptying.
- ▷ The water quantity can be monitored on the panel while the water tank is filled.

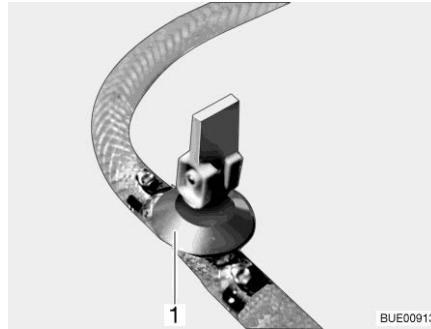

Fig. 192 Drain cock (with rocking lever)

- Position the vehicle horizontally.
- Switch on the 12 V power supply on the panel.
- If necessary, switch on the water pump on the panel.
- Clean or disinfect water system.
- Close all drain cocks. In order to do this, position the rocking lever of the drain cock (Fig. 192,1) horizontally.
- Close the drainage opening of the water tank.
- Close all water taps.
- Open the drinking water filler neck on the outside of the vehicle.



Fig. 193 Filling aid

- Plug the filling aid (Fig. 193,1) onto the drinking water filler neck.
- Fill the water tank with drinking water. Use a water hose, a water canister with a funnel or similar for filling.
- Set all the water taps to "Hot" and open them. The water pump is turned on. The warm water pipes are filled with water.
- Keep the water taps open until the water flowing out of the water taps has no bubbles in it. This is the only way to ensure that the boiler is full of water.
- Set all water taps to "Cold" and leave them open. This will fill the cold water pipes with water.
- Keep the water taps open until the water flowing out of the water taps has no bubbles in it.
- Close all water taps.

- Remove filling aid and close drinking water filler neck.
- Check that the cap on the water tank is not leaking.

Position of the drain cocks and safety/drainage valve

See chapter 17.

11.2.4 Topping up the water



- ▶ When filling the water tank, observe the maximum permissible gross weight of the vehicle. Luggage must be reduced accordingly when the water tank is full.

- Open drinking water filler neck.
- Fill the water tank with drinking water. Use a water hose, a water canister with a funnel or similar for filling.
- Close drinking water filler neck.

11.2.5 Closing/opening the overflow



- ▶ When filling the water tank, observe the maximum permissible gross weight of the vehicle. Luggage must be reduced accordingly when the water tank is full.

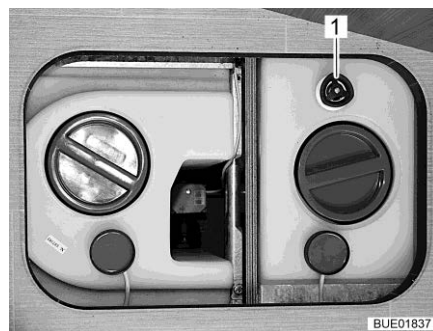

Fig. 194 Water tank with rotary handle

- Closing:**
- Turn the rotary handle (Fig. 194,1) on the water tank in a clockwise direction as far as it will go.
 - Fill the water tank with drinking water.
- Opening:**
- Turn the rotary handle (Fig. 194,1) on the water tank in an anticlockwise direction as far as it will go. The water drains away except for a residual amount of 20 l.

11.2.6 Draining water (rotary handle with overflow)

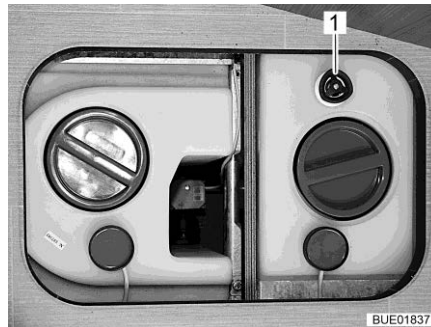

Fig. 195 Water tank with rotary handle

- Turn the rotary handle (Fig. 195,1) on the water tank in an anticlockwise direction as far as possible beyond the resistance to fully open the drainage opening.

11.2.7 Emptying the water system



- ▷ If the vehicle is not used for several days or if it is not heated when there is a risk of frost, empty the entire water system. Make certain that the water pump is switched off on the panel. Otherwise, the water pump will overheat and may get damaged. Leave the water taps on in central position. Leave the safety/drainage valve (if there is one) and all drain cocks open. Frost damage to appliances, frost damage to the vehicle and deposits in water-carrying components can be avoided in this way.
- ▷ If the water pump can be turned off from the panel, always turn off the water pump from the panel before you empty the water system. Otherwise the water pump runs until it overheats or the battery is empty.



- ▷ Take note of the environmental tip in this chapter.



- ▷ Depending on the model, the Alde system (heater/boiler) has one or two drain cocks for emptying.

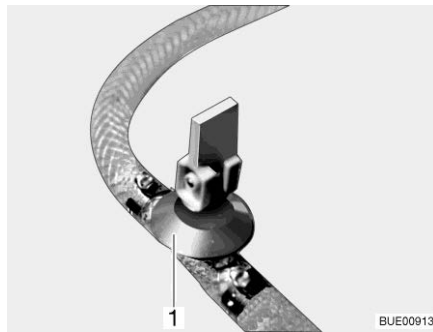

Fig. 196 Drain cock (with rocking lever)

To empty and ventilate the water system, proceed as follows. This will avoid frost damage:

- Position the vehicle horizontally.
- Switch off water pump on panel.
- Switch off the 12 V power supply on the panel.
- Shut off the boiler (see section 10.2).
- Open all drain cocks. In order to do this, position the rocking lever of the drain cock (Fig. 196,1) vertically.
- Open the water tank drain.
- Open all water taps and set to the central position.
- Hang the shower handset up in the shower position.
- Unscrew the lock ring on the water tank.
- Take water pump (fitted to the cover) as far as the connecting lines allow.
- Hold the water pump up until the water pipes are completely empty.
- Check whether the water tank is completely empty.
- Set the shower handset down in the shower tray.
- Blow out the remaining water in the water pipes (max. 0.5 bar). In order to do this, remove the water pipe from the water pump and blow into the water pipe in the direction of the appliances.
- Empty the waste water tank. Take note of the environmental tips in this chapter.
- Empty toilet cassette or sewage tank. Take note of the environmental tips in this chapter.
- Clean the water tank and then rinse it out thoroughly.
- Let the water system dry for as long as possible.
- After emptying, leave all water taps on in the central position.
- Leave all drain cocks open.

Position of the drain cocks and safety/drainage valve

See chapter 17.

11.3 Waste water installation



- ▷ Never pour boiling water directly into the sink outlet. Boiling water could cause deformation and leaks in the waste water pipe system.



- ▷ Only empty the waste water tank at disposal stations, camping sites or caravan sites especially provided for this purpose.

11.3.1 Drain cock in the vehicle



- ▷ If the living area heater is out of order, the waste water tank no longer is sufficiently protected against frost. Therefore in case of frost, empty the waste water tank and leave the drain cock open or add enough anti-freeze (e.g. kitchen salt) to the waste water tank to prevent the waste water from freezing.

The waste water tank is in the double floor of the vehicle. The waste water tank can be accessed via an external flap or a cover.

Waste water from the kitchen and washing unit flows through plastic pipes into the waste water tank.

The drain cock and the cleaning opening are located on the underside of the waste water tank.

The waste water tank holds 100 litres.

The vehicle is equipped with an electrically operated drainage valve.



Fig. 197 Drain pipe symbol

The position of the drain pipe is identified by a symbol (Fig. 197).

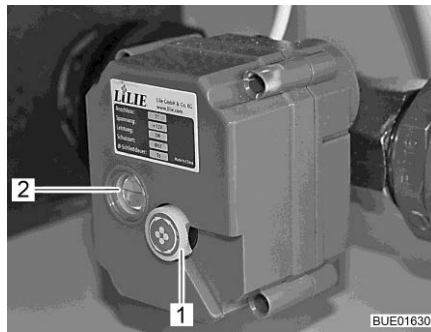

Fig. 198 Electrically operated drainage valve

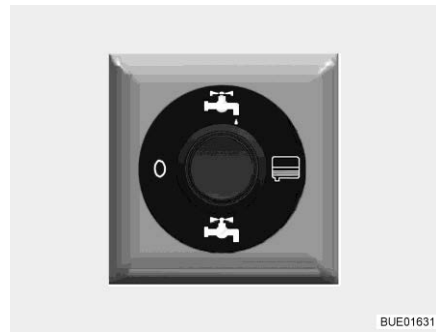

Fig. 199 Operating switch for electrically operated drainage valve (partially special equipment)

A red line in the inspection window (Fig. 198,2) of the electrically operated drainage valve shows the valve setting:

- horizontal line = valve open
- vertical line = valve shut

- Emptying:**
- Attach the waste water hose to the drain pipe.
 - Press the operating switch (Fig. 199) at the top. The waste water is drained.
 - Completely empty waste water tank.
 - Once all the waste water has drained completely, press the operating switch (Fig. 199) at the bottom.
 - Remove the waste water hose.

- Emergency drainage (electrically operated drainage valve):**
- Set the operating switch (Fig. 199) to the "0" position (power off).
 - Pull out the rotary knob (Fig. 198,1) on the electrically operated drainage valve and rotate (in any direction).

11.3.2 Heater for waste water tank and waste water pipes (special equipment)

In order to prevent waste water fittings freezing up, the waste water tank and the waste water pipes can be electrically heated separately.



- ▷ The heater for the waste water system requires up to 250 W during operation. Therefore, wherever possible, connect the vehicle to a 230 V power supply while the heater for the waste water system is working. The waste water heating continues to function even if the 12 V power supply is switched off on the panel.

In order to prevent the waste water installation from freezing, depending on the model and the equipment, the following components of the waste water system can be heated electrically:

- Waste water tank
- Waste water pipes
- Waste water tank and drainage

When the respective heater has been switched on, temperature sensors monitor the temperature of the waste water tank and the waste water pipes. If there is a risk of frost, the heating elements are switched on. If the temperature rises above a pre-set value, the heating elements are switched off again.

Position The heater for the waste water tank and the waste water pipes is normally installed in the bench seat.

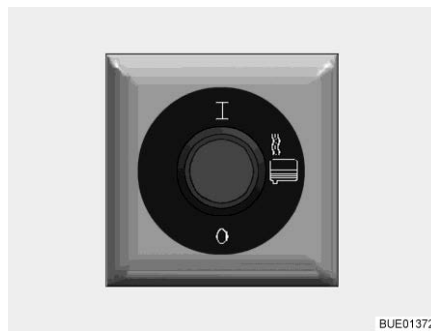

Fig. 200 Switch for waste water heating

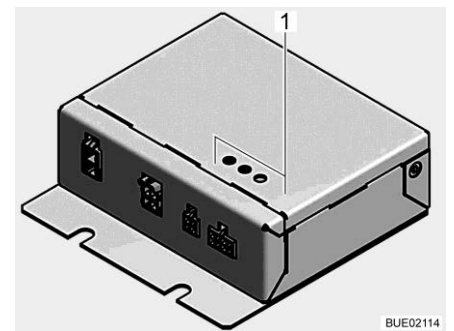

Fig. 201 Control unit for waste water heating

Switching on: ■ Press the upper part of the switch (Fig. 200). The waste water heating is switched on and prevents the heated components from freezing.

Switching off: ■ Press the lower part of the switch.

Three LEDs (Fig. 201,1) indicate the status of the control unit for the waste water heating:

LED HK 1 is lit	Heating circuit 1 is active
LED HK 2 is lit	Heating circuit 2 is active
LED HK 2 is flashing every 16 seconds	The device is in the power saving mode
LED ERR is flashing	The control has detected an error. Contact customer service



- ▷ Heating circuit 1 heats the waste water tank.
- ▷ Heating circuit 2 heats the waste water pipes and the waste water tank with emptying.
- ▷ If one of the two circuits (HK 1 or HK 2) is not connected, the LED assigned to the related heating circuit is flashing. This flashing is not an error message and may be ignored.

11.4 Toilet compartment



- ▷ Do not transport any loads in the shower tray. The shower tray or other items of equipment in the toilet compartment can be damaged.



- ▷ For ventilation purposes during or after a shower, and for drying wet clothing, close the toilet compartment door and open the window or the toilet compartment skylight. This improves the air circulation.
- ▷ Close the shower curtain completely when showering, so that no water is able to enter the area between the wash room wall and the shower tray.
- ▷ After taking a shower, rinse soap residue from the shower tray, otherwise cracks can appear in the shower tray over time.
- ▷ After using the shower, wipe it dry to prevent moisture from collecting.
- ▷ Further information about cleaning the toilet compartment can be found in the section 12.2.

11.5 Toilet



- ▷ If there is any risk of frost and the vehicle is not heated, empty the sewage tank (cassette).
- ▷ Do not sit on the lid of the toilet. The lid is not designed to bear the weight of a person and could break.
- ▷ Use a suitable chemical for this toilet. The ventilation will merely remove the odour but not germs and gases. Germs and gases will have a detrimental effect on the sealing rubbers.
- ▷ Never put the sanitary liquid directly in the toilet bowl.
- ▷ Do not drive when the sewage tank (cassette) is more than three-quarters full, as otherwise liquid may leak from the sewage tank through the ventilation system.



- ▷ Further information can be obtained in the device manufacturer's instruction manual.



- ▷ Only empty the sewage tank (cassette) at disposal stations, at camping sites or caravan sites, that are especially provided for this purpose.

The flushing of the toilet is fed directly from the water system of the vehicle.

11.5.1 Preparing toilet



- ▷ The sewage tank (cassette) can only be taken out if the sliding trap is closed.

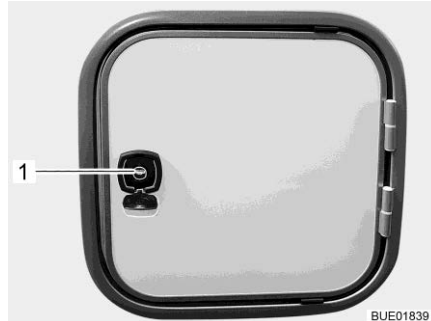

Fig. 202 Flap for sewage tank



Fig. 203 Sewage tank (example)

- Open the flap for the sewage tank on the outside of the vehicle. In order to do this, insert the key into the locking cylinder of the lock (Fig. 202,1) and turn a quarter turn.
- Open the flap.
- Pull up the retaining clip (Fig. 203,1) and lift the sewage tank (Fig. 203,2) straight up as far as it will go.
- Tilt the sewage tank slightly and remove fully.

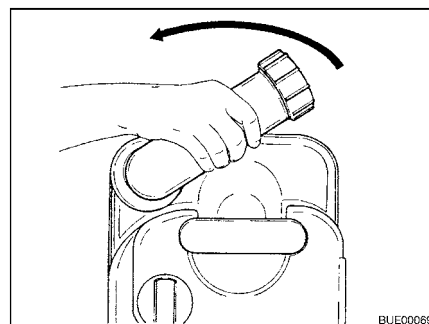

Fig. 204 Turning drainage neck

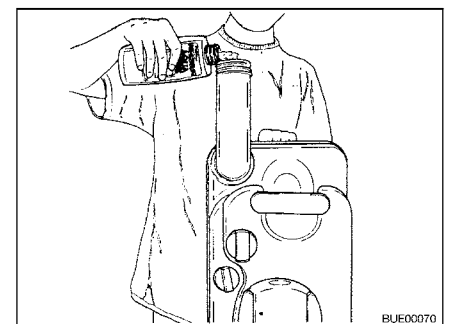

Fig. 205 Filling with sanitary liquid

- Put the sewage tank down vertically.
- Turn the drainage neck upwards.
- Remove the cap of the drainage neck.
- Fill the stated amount of sanitary liquid into the sewage tank.
- Then add enough water so that the bottom of the sewage tank is completely covered.
- Close drainage neck with the cap.
- Return the drainage neck to its original position.
- Push the sewage tank back to its original position without applying any force.
- Ensure that the sewage tank is secured by the retaining clip.
- Lock the flap for the sewage tank.

11.5.2 Swivel toilet

The flushing of the Thetford toilet is fed directly from the water system of the vehicle. The toilet bowl can be moved into the optimal position.

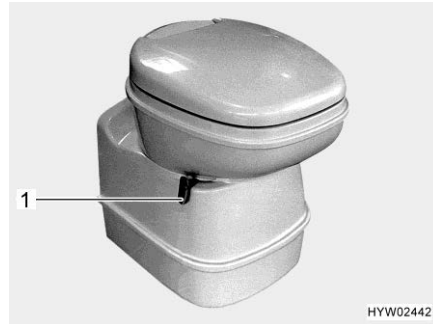

Fig. 206 Thetford toilet bowl, swiveling

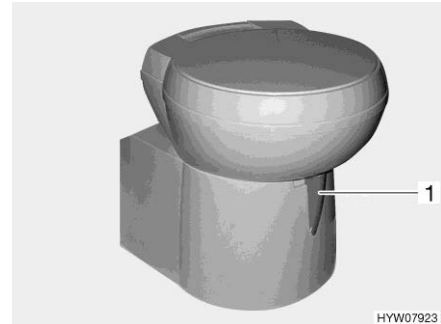

Fig. 207 Thetford toilet bowl, swiveling (alternative)

The operating unit is located close to the toilet bowl.

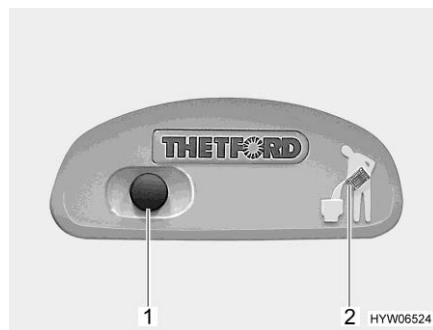

Fig. 208 Flush button/indicator lamp Thetford toilet

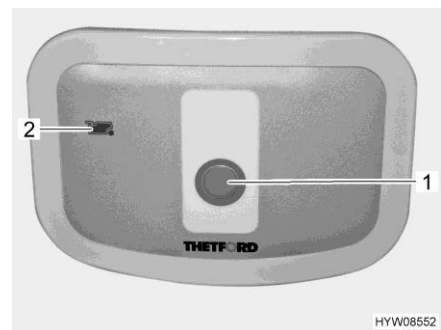

Fig. 209 Flush button/indicator lamp Thetford toilet (alternative)

- Flushing:**
- Before flushing open the sliding trap of the Thetford toilet. To do this, push the slide lever (Fig. 206,1 or Fig. 207,1) in an anticlockwise direction.
 - For flushing, press the blue flush button (Fig. 208,1 or Fig. 209,1).
 - After flushing close the sliding trap. To do this, push the slide lever in a clockwise direction.

The indicator lamp (Fig. 208,2 or Fig. 209,2) lights up whenever the sewage tank has to be emptied.

11.5.3 Emptying the sewage tank



▷ The sewage tank can only be taken out if the sliding trap is closed.

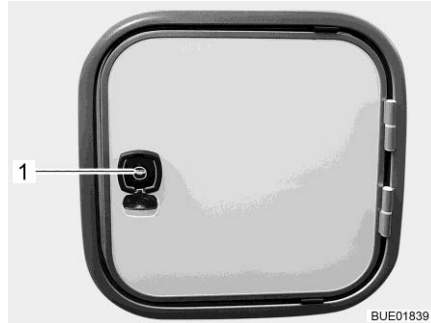

Fig. 210 Flap for sewage tank



Fig. 211 Sewage tank (example)

- Slide the slide lever on the toilet bowl in a clockwise direction. The sliding trap is closed.
- Open the flap for the sewage tank on the outside of the vehicle. In order to do this, insert the key into the locking cylinder of the lock (Fig. 210,1) and turn a quarter turn in a clockwise direction.
- Open the flap.
- Pull up the retaining clip (Fig. 211,1) and lift the sewage tank (Fig. 211,2) straight up as far as it will go.
- Completely empty the sewage tank at disposal stations that are especially provided for this purpose.



▷ Actuate the aeration knob on the sewage tank with your thumb to empty it completely.

Chapter overview

This chapter contains instructions regarding the care of the vehicle.

At the end of the chapter there is a checklist of measures you must carry out if you are not going to use the vehicle for an extended period of time.

12.1 External care

12.1.1 General

Standard external care consists of regular washing. The use and the environmental conditions will determine how often the vehicle needs to be washed. Wash the vehicle more frequently in areas which are exposed to heavy air pollution or heavy traffic or roads treated with de-icing salts. If the vehicle is exposed to salty and humid air (coastal areas, humid climates), wash the vehicle more frequently.

Do not park under trees if at all possible. The resin-like discharge which many trees secrete, give the paintwork a matt look and can promote the onset of corrosion.

Wash off bird droppings straight away and thoroughly, as the acid it contains is extremely corrosive.

12.1.2 Washing with a high-pressure cleaner



- ▷ Do not clean the tyres with a high-pressure cleaner. The tyres might be damaged.
- ▷ Do not spray external applications (deco-films) directly with the high-pressure cleaner. The external applications could come off.

Before cleaning the vehicle with a high-pressure cleaner, observe the operating manual of the high-pressure cleaner.

When cleaning with the nozzle for circular jet between the vehicle and the cleaning nozzle, maintain a minimum distance of approx. 700 mm.

Take into consideration that the jet of water comes out of the cleaning nozzle with pressure. The vehicle may be damaged by incorrect handling of the high-pressure cleaner. The temperature of the water should not be above 60 °C. Keep the jet of water in constant movement during the washing process. Do not direct the water jet at clearances, built-in electrical parts, plugs, seals, the ventilation grill or the skylights. The vehicle may be damaged or water may enter the interior.

12.1.3 Washing the vehicle



- ▷ Never clean the vehicle in the car wash. Water can penetrate the refrigerator grills, the waste gas vent or the forced ventilations. The vehicle could be damaged.

- Wash the vehicle only on a washing site intended for this purpose.
- Avoid full sunshine. Observe environmental measures.
- Only clean external applications and synthetic parts with plenty of warm water, dish washing liquid and soft cloth.
- Wash down the vehicle with plenty of water, a clean sponge or a soft brush. In the case of stubborn dirt add dish washing liquid to the water.
- Painted exterior walls may also be cleaned with a caravan cleaner.
- Add-on parts made of glass-fibre reinforced plastic (GRP) require a regular follow-up treatment with a polisher. This way these parts will not turn yellow and the sealing of the surface remains intact.
- Rub a conventional rubber care product onto the rubber seals on doors and storage flaps.
- Treat locking cylinder of doors and storage flaps with graphite dust.

12.1.4 Windows of acrylic glass

Acrylic glass windows are delicate and require very careful handling.



- ▷ Never rub acrylic glass windows dry as dust particles might damage the surface.
- ▷ Only clean acrylic glass windows with plenty of warm water, some dish washing liquid and a soft cloth.
- ▷ Never use glass cleaning agents with chemical, abrasive or alcohol-containing additives. Premature brittleness of the panes and associated cracks may result from their use.
- ▷ Avoid contact of cleansing agents used for the body (e.g. tar- or silicone-removing agents) with acrylic glass.
- ▷ Do not clean vehicle in car wash.
- ▷ Do not attach stickers to the acrylic glass windows.
- ▷ Having cleaned the vehicle rinse acrylic glass with sufficient clear water.
- ▷ Treat rubber seals with a conventional rubber care product.



- ▷ An acrylic glass cleanser with antistatic effect is suitable for a follow-up treatment. Small scratches can be treated with an acrylic glass polish. These agents are available at the accessories shop.

12.1.5 Entrance step

If the entrance step is lubricated, coarse particles of dirt can settle on the lubricant during the journey and cause damage to the operating mechanism of the entrance step. Therefore, do not lubricate the moving parts of the entrance step.

12.1.6 Air suspension



- ▷ Never clean the individual parts of the air suspension with steam or high-pressure cleaners, abrasive or organic solvents.

Clean the air suspension bellows, air duct and shock absorber regularly. Use soapy water, methanol, ethanol or isopropyl alcohol for cleaning.

12.2 Interior care



- ▷ If possible, treat stains immediately.
- ▷ Acrylic glass windows are delicate and require very careful handling (see section 12.1.4).
- ▷ Synthetic parts in the toilet and living area are very delicate and should be treated with care. Do not use solvents, alcohol-containing cleansers or scourers. This procedure will help you to avoid brittleness and formation of cracks.
- ▷ Hair colourants, nail varnish, cigarette ash and similar substances may cause permanent stains or discolouration. For this reason, you should prevent these substances from getting onto plastic parts. If they do get onto plastic parts, you should remove these substances immediately.
- ▷ Do not pour any corrosive agents into the drain holes. Never pour boiling water directly into the drain holes. Corrosive agents and boiling water cause damage to drainage pipes and siphon traps.
- ▷ Do not use vinegar based products to clean the toilet and water system, or for descaling the water system. Vinegar-based products may cause damage to seals or parts of the installation. Use standard descaling products for descaling.
- ▷ Save water. Mop up all remaining water.
- ▷ Vacuum off carpets and cushions with a suitable brush attachment.



- ▷ For information about the use of maintenance products, our representatives and service centres will be glad to advise.
 - Surface and knobs of furniture, lamps and synthetic parts in the toilet and living area should be cleaned with water and a wool cloth. A mild cleanser may be added to the water. If required, use furniture polish for the painted surfaces.
 - Clean upholstery with dry foam specially manufactured for the use on upholstery or with the foam of a mild detergent. Do not wash upholstery. Always have it cleaned. Protect cushions from direct sunlight so that they do not lose their colour.
 - Leather covers should be cleaned with a cotton cloth and a mild soap (curd soap). Make sure that the leather is not soaked through and that no water seeps through the seams of the leather covers.
 - Wash panel curtains and gathered blinds. When washing observe washing instructions on the product. The sticks may be removed for washing.
 - Vacuum clean the carpet, if necessary clean with carpet shampoo.

- Clean PVC-floor covering with a mild, soapy cleaning agent for PVC floors. Do not place carpet on wet PVC-floor covering. The carpet and the PVC-floor covering may stick together.
- Clean the sink cover manually using water and washing-up liquid. Do not clean the sink cover in the dishwasher.
- Never clean the sink or the gas cooker with a scourer. Avoid anything which may cause scratching or grooves.
- Clean the burners on the gas cooker using a damp cloth only. Prevent any water from penetrating the burner covers. Water may damage the burners on the gas cooker.
- Brush insect screens on doors, windows and skylights with a soft brush or vacuum with the brush attachment of the vacuum cleaner.
- Brush blinds with a soft brush or vacuum with the brush attachment of the vacuum cleaner. Grease or stubborn dirt may be removed with a mild soap at 30 °C (curd soap).
- Brush Roman shades with a soft brush or vacuum with the brush attachment of the vacuum cleaner. Grease or stubborn dirt may be removed with a mild soap at 30 °C (curd soap).
- Unrolled seat belts can be cleaned with warm soapsuds. The seat belt must be completely dry before being rolled up.

12.3 Water system

12.3.1 Cleaning the water tank

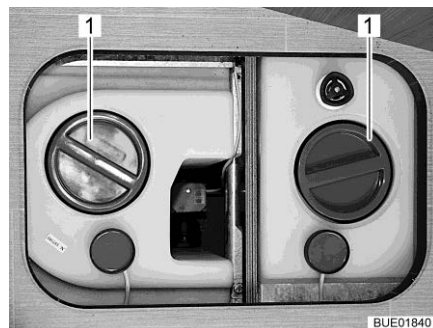

Fig. 212 Water tank with rotary handle

- Empty the water tank and close the drainage opening.
- Remove the cap (Fig. 212,1) of the water tank.
- Fill water tank with water and some washing-up liquid (do not use any scourers).
- Using a trade standard brush for washing dishes, scrub the water tank until there is no longer any visible deposit.
- If possible, clean fresh water sensors through the cleaning openings by hand.
- Rinse water tank with copious amounts of drinking water.



- ▷ If, due to the design of the water tank, it is not possible to clean the water tank mechanically: Use a suitable chemical cleaning agent.
- ▷ The authorised dealers would be happy to assist you in choosing a suitable cleaning agent.
- ▷ Follow the cleaning agent manufacturer's instructions.

12.3.2 Cleaning the water pipes



- ▷ Only use suitable cleaning agents as sold by the specialist trade.
- ▷ The cleaning agent must meet national regulations and be approved (if required).



- ▷ Collect any emerging mixture of water and cleaning agent for correct disposal.
 - Empty the water system.
 - Close all drainage openings and drain cocks.
 - Fill mixture of water and cleaning agent into the water tank. Observe the manufacturer's instructions regarding the mixing ratio.
 - Open the drain cocks one by one.
 - Leave the drain cocks open until the mixture of water and cleaning agent has reached the respective drain.
 - Close the drain cocks.
 - Set all the water taps to "Hot" and open them.
 - Leave the water taps open until the mixture of water and cleaning agent has reached the drain.
 - Set all water taps to "Cold" and open them.
 - Leave the water taps open until the mixture of water and cleaning agent has reached the drain.
 - Close all water taps.
 - Flush the toilet several times.
 - Allow the cleaning agent to act in accordance with the manufacturer's instructions.
 - Empty the water system. Collect the mixture of water and cleaning agent for correct disposal.
 - For rinsing fill the entire water system with drinking water and empty again several times over.

12.3.3 Disinfecting the water system



- ▷ Only use suitable disinfectants as sold by the specialist trade.
- ▷ The disinfectant must meet national regulations and be approved (if required).



- ▷ Collect any emerging mixture of water and disinfectant for correct disposal.

When disinfecting the water system, proceed the same way as when cleaning the water pipes (see section 12.3.2). Simply use disinfectant instead of cleaning agent.

12.3.4 Cleaning the waste water tank

Clean the waste water tank after every use.

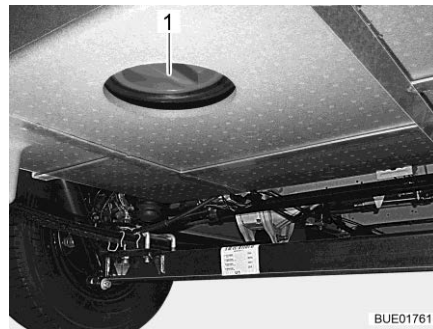

Fig. 213 Cleaning opening (waste water tank)

- Empty the waste water tank.
- Open the cleaning opening (Fig. 213,1) on the waste water tank and the drain cock.
- Thoroughly rinse out the waste water tank with fresh water.
- If possible, clean waste water sensors through the cleaning opening by hand.

12.4 Extractor hood

Clean the extractor hood filter occasionally. How often cleaning is necessary depends on how often the extractor hood is used. Do not wait to clean the filter until the performance of the extractor hood has noticeably decreased.

- Cleaning the filter:
- Wash the filter with warm water and some washing-up liquid.

12.5 Air conditioning unit

12.5.1 Truma



- ▷ Do not clean the air conditioning unit with a high-pressure cleaner. Water entering can damage the air conditioning unit.
- ▷ Do not clean vehicle in car wash.
- ▷ Do not use any sharp or hard objects when cleaning. Otherwise the air conditioning unit could be damaged.
- Use only water and a gentle cleaning agent to clean the air conditioning unit.
- Wipe the air conditioning unit housing and the air outlet occasionally with a damp cloth.
- Clean the remote control occasionally with a slightly damp cloth. Clean the display with a spectacles cleaning cloth.
- Remove leaves and other dirt from the ventilation openings on the air conditioning unit regularly.
- Check the condensation drain holes regularly to ascertain whether the condensation can run off freely.
- Clean the filters on both sides of the air discharge unit regularly.



- ▷ Further information can be obtained in the manufacturer's instruction manual.

12.5.2 Telair

Every now and then clean the filter and the ventilation grilles on the outside of the housing. How often cleaning is necessary depends on how often the air conditioning unit is used. Do not wait to clean the filter and the ventilation grill until the performance of the air conditioning unit has noticeably decreased.



- ▷ Only use mild cleaning solutions to clean the filter, never use benzene or solvents.

Cleaning the filter:

- Wash the filter with warm water and some washing-up liquid.
- Allow the filter to dry thoroughly before reassembly.

Cleaning the ventilation grill:

- Use a brush to remove coarse dirt or deposits from the external ventilation grilles. If a cleaning solution is used, ensure that no water ingresses into the inside of the housing.

12.6 Winter care

De-icing salt damages the underbody and the parts open to water spray. We recommend that you wash the vehicle more frequently during wintertime. Mechanical and surface treated parts and the underside are under particular strain, and should therefore be cleaned thoroughly.



- ▷ If there is any risk of frost, always run heater at a minimum of 15 °C. Switch the circulation fan (if there is one) to automatic. In the case of extreme external temperatures, the furniture flaps and doors should be left slightly open. The inflowing warm air can help prevent the freezing of water pipes, for example, and counteract the formation of condensation in the storage spaces.
- ▷ If there is any risk of frost, cover the outside surface of the windows with winter insulation mats.
- ▷ Keep waste gas vents and forced ventilations free of snow. Use a vent extension, if necessary.

12.6.1 Preparations

- Check the vehicle for paint and rust damage. Repair damage as necessary.
- Make certain that water cannot penetrate the automatic floor ventilation system and the heater.
- Use a wax-based rust inhibitor to protect the metal parts of the underbody.
- Use appropriate protection for external painted surfaces.

12.6.2 Winter operation

During winter operation, condensation develops when the vehicle is occupied under low-temperature conditions. To ensure good interior air quality and avoid vehicle damage from condensation, sufficient ventilation is essential.

- When heating the vehicle, the heater should be at the highest setting and roof storage cabinets, curtains and blinds should be opened. This ensures optimal ventilation.
- Only heat if the circulation system is switched on.
- In the morning, lift up all cushions, air out storage boxes and dry any damp areas.



- ▷ If condensation has still developed, just wipe it off.
- ▷ It is only possible to guarantee unrestricted operation during winter for models without double floor in connection with the "winter package" from the original equipment.

12.6.3 At the end of the winter season

- Thoroughly clean the underbody of the vehicle and the engine. When this is done, corrosion-inducing anti-freeze agents (salts, alkaline residues) are removed.
- Clean the exterior and use regular car wax to protect metal surfaces.

12.7 Lay-up

12.7.1 Temporary lay-up



- ▶ If the vehicle has been stationary for a long period (approx. 10 months) have the braking and gas systems checked by an authorised specialist workshop.
- ▶ Take into consideration that water is undrinkable after only a short time.
- ▶ Animal damage to cables can lead to short circuits. Fire hazard!

Before laying up the vehicle, go through the following checklist:

	Activity	Done
Base vehicle	Completely fill fuel tank. This prevents corrosion damage within the fuel tank system	
	Jack up vehicle so that the wheels do not bear any load, or move vehicle every 4 weeks. This prevents any pressure points from occurring on tyres and wheel bearings	
	Protect the tyres from direct exposure to the sun. Danger of formation of cracks!	
	Inflate tyres up to the recommended maximum pressure	
	Always provide for sufficient ventilation in the underbody area  ▶ Humidity or lack of oxygen e.g. by covering with plastic film may cause optical irregularities to the underbody	
	In addition observe the notes in the operating manual of the base vehicle	
Body	All vents should be sealed with the appropriate caps and all other openings (apart from forced ventilations) should also be sealed. This prevents animals (e.g. mice) from gaining entry	
	Air the interior, all storage spaces accessible from the outside, and the parking space (e.g. garage) every 3 weeks in order to prevent the occurrence of condensation and resulting mould formation	

	Activity	Done
Interior	Place upholstery in an upright position for ventilation, and cover	
	Clean refrigerator	
	Allow refrigerator and freezer compartment doors to remain slightly open	
	Search for traces of animals that have gained entry	
	Disconnect the flat screen from the mains and, if necessary, remove it from the vehicle	
Gas system	Close regulator tap on the gas bottle	
	Close all gas isolator taps	
	Always remove gas bottles from the gas bottle compartment, even if they are empty	
Electrical system	Fully charge living area and starter battery  ▷ Charge the battery for at least 20 hours before laying up.	
	Disconnect the living area battery from the 12 V power supply. In order to do this switch off the battery cut-off switch on the transformer/rectifier or activate the battery separation via the panel (see chapter 9)	
Water system	Empty the entire water system. Blow out the residual water from the water pipes (0.5 bar max.). Leave the water taps on in central position. Leave all drain cocks open. Observe the notes in chapter 11.	

12.7.2 Winter lay-up

Additional measures are required if laying up the vehicle over winter:

	Activity	Done
Base vehicle	Clean body and underbody thoroughly and spray with hot wax or protect with varnish	
	Fill fuel tank with winter diesel	
	Check antifreeze in the cooling water	
	Rectify damage to the paintwork	
	Fill in windscreen washer fluid with frost protection	

	Activity	Done
Body	Clean vehicle from outside thoroughly	
	Keep the forced ventilation open	
	Clean and grease installed supports	
	Clean and grease all door and flap hinges	
	Brush oil or glycerine on all locking mechanisms	
	Treat all rubber seals with a conventional rubber care product	
	Use graphite dust to treat locking cylinders	
Interior	Set up the de-humidifier (granulate)	
	Remove cushions and mattresses from the vehicle and store them in a dry place	
	Air the interior every 3 weeks	
	Empty all cabinets and storage compartments, open flaps, doors and drawers	
	Thoroughly clean the interior	
	If there is a risk of frost, do not leave the flat screen in the vehicle	
Electrical system	Remove the starter battery and the living area battery and store them in a place protected from frost (see chapter 9) or connect the vehicle to a 230 V supply. Before removing, remove the fuses on the living area battery	
Water system	Clean the water system using a cleaning agent from a specialised store	
Complete vehicle	Arrange the tarpaulins in such a way that the ventilation openings are not covered, or use porous tarpaulins	

12.7.3 Starting up the vehicle after a temporary lay-up or after lay-up over winter

Go through the following checklist before start-up:

	Activity	Done
Base vehicle	Check the tyre pressure on all tyres	
	Check the tyre pressure of the spare wheel (if present)	
Body	Clean the pivot bearing of the entrance step	
	Check the functioning of the fitted supports	
	Check that the doors, windows and skylights are working properly	
	Check that all the external locks are working, such as the storage flaps, the filler neck and the conversion door	
	Remove the cover from the waste gas vent of the heater (if there is one)	
	Remove the winter cover from the refrigerator grills (if there is one)	
Gas system	Put the gas bottles in the gas bottle compartment, tie down and connect to the gas pressure regulator	
Electrical system	Connect to 230 V external power supply	
	Install the living area battery and starter battery, insert the fuses on the living area battery and fully charge the battery	
	 ▷ Charge the battery for at least 20 hours after lay-up.	
	Connect the living area battery with the 12 V power supply. In order to do this switch on the battery cut-off switch on the transformer/rectifier or deactivate the battery separation via the panel (see chapter 9)	
	Check that the electrical system are working, e.g. interior light, socket and all installed electrical appliances	
Water system	Disinfect water pipes and water tank	
	Check the functionality of the operating lever for the waste water tank	
	Close all drain cocks and water taps	
	Check water system for leaks	
Appliances	Check the function of the appliances	

Chapter overview

This chapter contains instructions about official inspections and inspection and maintenance work in the vehicle.

At the end of the chapter you will find important instructions on how to obtain spare parts.

13.1 Official inspections

Depending on the national legislative provisions, the following official inspections must be carried out periodically:

- Main inspection
- Emissions test
- Inspection of the gas system

The inspection intervals in accordance with the national legislative provisions must be adhered to. The inspection stickers attached to the vehicle indicate when the next inspection is required.



- ▷ Any changes on the gas system must be carried out by an authorised specialist workshop.
- ▷ Even in the case of vehicles that are not registered, an inspection of the gas system is required.

13.2 Inspection work

Like any technical appliance, the vehicle must be inspected at regular intervals.

This inspection work must be carried out by qualified personnel.

Special technical knowledge, which cannot be taught within the framework of this instruction manual, is required for these tasks. Personnel possessing this technical knowledge are available for assistance at all our service centres. Their experience and regular technical instruction by the factory as well as equipment and tools guarantee expert and up-to-date inspection of the vehicle.

Have the "First Programmed Inspection" carried out at one of our service centres 12 months after initial registration.

Further inspections should be carried out once a year.

The service centre in charge will confirm the work performed.

Have chassis inspections confirmed in the chassis manufacturer's customer service booklet.



- ▷ Observe the inspections indicated by the manufacturer and have them carried out at the specified intervals. The value of the vehicle is thus preserved.
- ▷ The confirmation of the inspection work carried out serves as valid proof in the event of damage and guarantee claims.

13.3 Maintenance work

As with every machine, this vehicle requires maintenance. The extent and frequency of the maintenance work required depend on conditions of operation and use. More difficult operating conditions make it necessary to service the vehicle more often.

Have the base vehicle and the appliances serviced at the intervals specified in the corresponding instruction manuals.

13.4 Doors

13.4.1 Conversion door

To maintain gliding capability between springs and hinges, grease the conversion door hinges occasionally.



- ▷ We recommend either Molykote PG 65 or Vaseline as lubricants.

13.4.2 Driver's door

To preserve the functional properties of the driver's door, lubricate the driver's door from time to time.

Lubricating the driver's door:

- Lubricate the locking system and the locking claws with an adherent lubricating oil (e.g. HHS 2000).
- Grease the door catch strap with machine grease or an equivalent grease.

13.5 Living area battery

Observe the following to extend battery life:

- Keep the battery surface clean and dry.
- Protect the battery poles and the terminals from corrosion.
- Check the charging condition periodically or use a charge conservation device.
- Always keep stored batteries in charged condition and in a cool place.

13.6 Alde hot-water heater



- ▷ Check the level of the heating fluid regularly on the compensator reservoir.
- ▷ During or after the first operating hours of the hot-water heater, the filling level may fall below the minimum mark. If this is the case, top up the heating fluid.
- ▷ We recommend to bleed the heating system after the initial heater operation and to check the glycol content.



- ▷ Have heating fluid changed by an authorised dealer or a service centre at intervals of five years as corrosion-protection wears off after some time.
- ▷ Only top up heating system with a standard G13 water-glycol mixture (60 : 40). This mixture offers frost protection up to approx. -25 °C. When topping up hot-water heaters that are connected to the engine's cooling circuit, please observe the instructions in the manufacturers' instruction manuals.



- ▷ Further information can be obtained in the manufacturer's instruction manual.
- ▷ Depending on the equipment, there is an underfloor heater in the driver's cabin. Small amounts of heating fluid can escape when the quick-release connections are disconnected.

13.6.1 Checking the fluid level

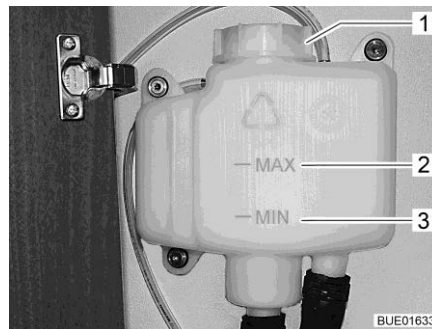

Fig. 214 Compensator reservoir without panel

- Switch off the hot-water heater and allow it to cool down.
- Check if the fluid level is between the marks "MIN" (Fig. 214,3) and "MAX" (Fig. 214,2) on the compensator reservoir (Fig. 214).

13.6.2 Topping up heating fluid

- Position the vehicle horizontally. This prevents the formation of bubbles.
- Switch off the hot-water heater and allow it to cool down.
- If necessary, unscrew or remove the panel (depending on the model).
- Open the rotary lid (Fig. 214,1) on the compensator reservoir.
- Remove cover.
- Check anti-freeze with an anti-freeze hydrometer. The frost protection content must be 40 % or correspond to a frost protection of -25 °C.
- Fill water frost protection mixture slowly into the compensator reservoir.



- ▷ The optimum fluid level is reached when the fluid in the compensator reservoir is 1 cm above the "MIN" mark when it is cooled down.

13.6.3 Bleeding the heating system



Fig. 215 Bleeding valve of hot-water heater

The bleeding valves are built in nearby the radiators. For position of the bleeding valves, see also table "Position of the bleeding valves".

- Switch off the hot-water heater and allow it to cool down.
- Open bleeding valve (Fig. 215,1) and leave open until no more air escapes.
- Close bleeding valve.
- Repeat this procedure at all bleeding valves.
- Check to see if the hot-water heater warms up.

13.6.4 Position of the bleeding valves

I 840

Position of the bleeding valves	
	Complete emptying under the vehicle under the service unit
	At the auxiliary heat exchanger in the service unit
	In the front bench seat of the central seating group
	Behind the backrest of the divan on the L-seating group on the left and right
	Underneath the driver's and front passenger's seats
	In the passenger's door panelling at the front (release the screws of the panelling)
	Behind the backrest of the lateral bench seat (behind the right-hand vehicle seat)
	In the bench on the right next to the conversion door
	Under the refrigerator
	At the foot end of the rear bed, left and right
	On the 3-way valve under the bed on the right
	In the wardrobe next to the shower, on the right
	In the steps to the rear bed behind and opening
	In the cabinet underneath the right-hand rear bed, behind a round opening

I 910**Position of the bleeding valves**

Complete emptying under the vehicle under the service unit
At the auxiliary heat exchanger in the service unit
In the front bench seat of the central seating group
Behind the backrest of the divan on the L-seating group on the left and right
Underneath the driver's and front passenger's seats
On the passenger side, behind the panelling at the front (release the screws of the panelling)
Behind the backrest of the lateral bench seat (behind the right-hand vehicle seat)
In the bench seat on the right next to the conversion door
Under the refrigerator
At the foot end of the rear bed, on the right and the left
On the 3-way valve under the bed on the right
In the steps to the rear bed behind a round opening
In the wash basin bottom cupboard

I 920

Complete emptying under the vehicle under the service unit
At the auxiliary heat exchanger in the service unit
In the front bench seat of the central seating group
Behind the backrest of the divan on the L-seating group on the left and right
Underneath the driver's and front passenger's seats
On the passenger side, behind the panelling at the front (release the screws of the panelling)
Behind the backrest of the lateral bench seat (behind the right-hand vehicle seat)
In the bench seat on the right next to the conversion door
Under the refrigerator
Underneath the bed on the right (access through the garage flap underneath the hydraulic pump of the bed)
In the wash basin bottom cupboard
In the television bottom cupboard at the rear bed on the left, behind an opening

13.7 Replacing bulbs, external



- ▶ Bulbs and light fittings can be extremely hot. Therefore, allow lights to cool down before changing bulbs.
- ▶ Store bulbs in a safe place inaccessible to children.
- ▶ Do not use any bulb that has been dropped or which shows scratches in its glass. The bulb might burst.



- ▷ A new bulb should not be touched with the fingers. Use a cloth when installing the new bulb.
- ▷ Use only bulbs of the same type and with the correct wattage (see section 13.7.4).
- ▷ If LEDs in lights are defect, contact an authorised dealer or service centre.

Types of bulbs

Different types of bulbs are used in the vehicle. Below, we have described how to change the different types of bulbs.

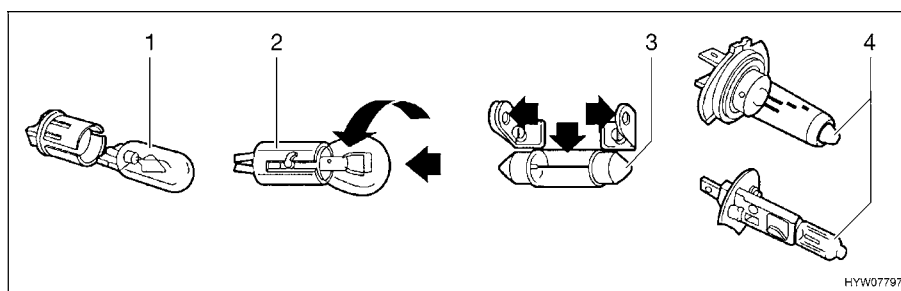
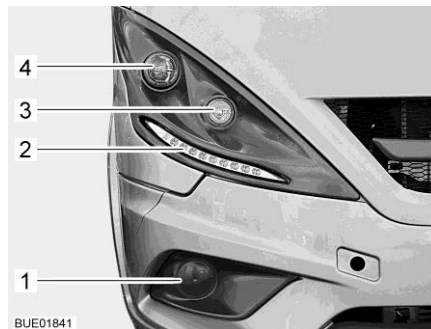

Fig. 216 Types of bulbs

Pos. in Fig. 216	Fixture type/bulb type	Changing
1	Plug-in fixture	To remove, pull out the bulb
		To mount, push the bulb into the socket with gentle pressure
2	Bayonet socket	To remove, press the bulb down and turn in an anticlockwise direction
		To insert, place the bulb in the socket and turn in a clockwise direction
3	Cylindrical bulbs	To remove and to insert, carefully bend the contacts of the lamp holder outwards
4	Halogen bulb	To remove, release retaining springs
		After inserting, hook the retaining springs again

13.7.1 Front lights



- 1 Fog light (optional)
- 2 Daytime running light (LED)
- 3 Direction indicator
- 4 Low beam/main beam

Fig. 217 Front lights

Low beam/main beam The bulbs are changed in the engine compartment.

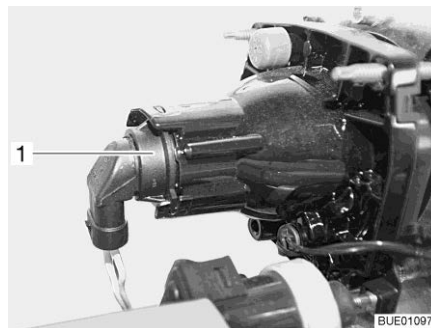

Fig. 218 Low beam/main beam/parking light

- Open the bonnet (see chapter 5).
- Put your hand behind the lamp holder (Fig. 218,1).
- Turn the lamp holder with the lamp in an anticlockwise direction and remove.
- Turn bulb in an anticlockwise direction and remove from the holder.
- Put in a new bulb.

Direction indicator The bulbs are changed in the engine compartment.

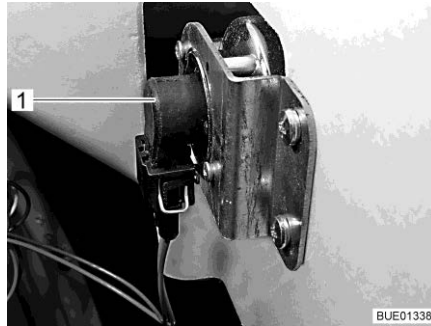

Fig. 219 Direction indicator

- Open the bonnet (see chapter 5).
- Put your hand behind the lamp holder (Fig. 219,1).
- Turn the lamp holder with the lamp in an anticlockwise direction and remove.
- Remove bulb.
- Put in a new bulb.
- Reassemble the direction indicator in the reverse order.

Daytime running light The lights have LEDs. To change the LEDs, contact an authorised dealer or a service centre.

Fog light The bulbs are changed in the engine compartment.

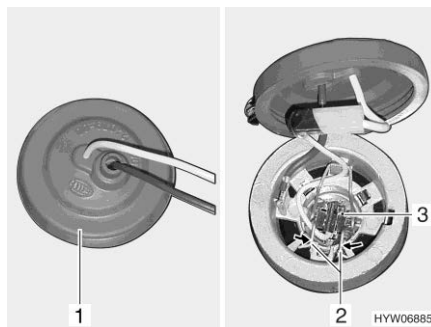
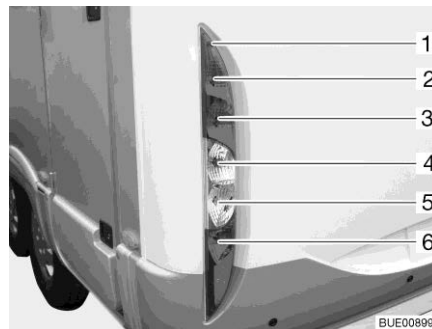

Fig. 220 Fog light

- Open the bonnet (see chapter 5).
- Put your hand behind the fog light and remove rubber cap (Fig. 220,1) from lamp housing.
- Press metal clip (Fig. 220,2) together and release from holder.
- Remove bulb (Fig. 220,3) with cable from lamp housing.
- Put in a new bulb.
- Reassemble the lamp in the reverse order.

13.7.2 Rear lights



- 1 Housing screws
- 2 Rear light
- 3 Brake light
- 4 Direction indicator
- 5 Reverse light
- 6 Fog tail light

Fig. 221 Rear lights

- Undo the housing screws (Fig. 221,1).
- Remove the housing.
- Remove bulb.
- Put in a new bulb.
- Reassemble the lamp in the reverse order.

13.7.3 Side lights

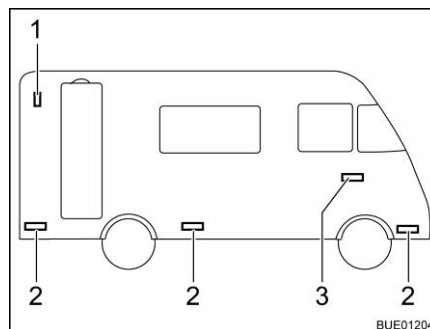

- 1 Side marker light
- 2 Marker light
- 3 Direction indicator

Fig. 222 Side lights

Side marker light The side marker light (Fig. 222,1) is fixed in the rear area at the top.



- ▷ Please have the LEDs of the side marker light replaced at a service centre.

Direction indicator The lamp is glued in. If the bulb is faulty, contact an authorised dealer or service centre.

Marker lights The marker lights (Fig. 222,2) are fitted in the lower part of the vehicle.



- ▷ The lights have LEDs. To change the LEDs, contact an authorised dealer or a service centre.

13.7.4 Types of bulbs for exterior lighting

	Exterior lighting	Type of bulb
Front	Main beam	H7 12 V 55 W
	Low beam	H7 12 V 55 W
	Direction indicator	Bay 9s 12 V 21 W
	Fog light	H3 12 V 55 W

Rear	Rear light	Ba15s 12 V 5 W
	Brake light	Ba15s 12 V 21 W
	Direction indicator	Ba15s 12 V 21 W
	Fog tail light	Ba15s 12 V 21 W
	Reverse light	Ba15s 12 V 21 W
	Third brake light	LED

13.8 Replacing bulbs, internal



- ▶ Bulbs and light fittings can be extremely hot. Therefore, allow lights to cool down before changing bulbs.
- ▶ Shut off the power supply on the safety cut-out in the 230 V fuse box before changing bulbs.
- ▶ Store bulbs in a safe place inaccessible to children.
- ▶ Do not use any bulb that has been dropped or which shows scratches in its glass. The bulb might burst.
- ▶ Halogen lamps can get very hot. When the light is switched on, there must always be a safety distance of 30 cm between light and flammable objects. Fire hazard!
- ▶ Do not replace the LEDs in lamps with standard light bulbs. Risk of fire due to intense heat build up.



- ▷ A new bulb should not be touched with the fingers. Use a cloth when installing the new bulb.
- ▷ Only use bulbs of the same type and with the correct wattage.
- ▷ If LEDs in lights are defect, contact an authorised dealer or service centre.

13.8.1 Light with LED

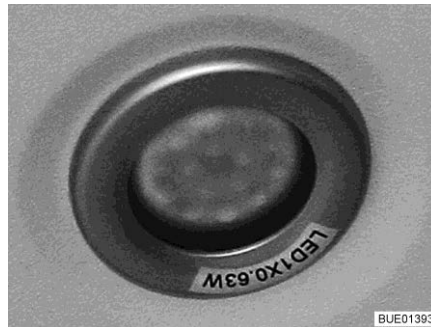

Fig. 223 Recessed light (example)



- ▷ LED lights have a very long life. It is not normally necessary to replace a light.

Changing bulbs:

- Contact a dealer or service centre.

13.9 AL-KO rear axle

Fiat vehicles with AL-KO rear axle without air suspension

In addition to the regulations and notes in the operator manual of the basic vehicle as well as in the maintenance manual, the rear axles must be relubricated after 20,000 km, or at least every 12 months.



- ▷ The rear axles must not bear any load while they are being lubricated.
- ▷ Use one of the following types of grease for lubrication:
Costrac GL 1501 by the firm Klüber
Cardex 3746 SP by the firm CONDA



- ▷ If the vehicle is equipped with a maintenance-free torsion bar spring axle or a rear axle with air suspension, the two lubricator nipples are left out.

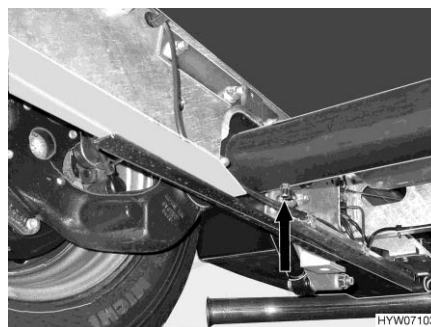

Fig. 224 AL-KO rear axle (Fiat)

The lubricator nipples (Fig. 224, arrow) are situated on the underside of the axle tube.

13.10 Spare parts



- ▶ Every alteration of the original condition of the vehicle can alter road behaviour and jeopardize road safety.
- ▶ The special equipment and original spare parts recommended by us have been specially developed and supplied for your vehicle. These products are available at the authorised dealer or service centre. The authorised dealer or service centre is informed about admissible technical details and carries out the required work correctly.
- ▶ The use of accessories, parts and fittings not supplied by us may cause damage to the vehicle and jeopardize road safety. Even if an expert's report, a general type approval or a design certification exists, there is no guarantee for the proper quality of the product.
- ▶ No liability can be assumed for damage caused by products which have not been released by us. This also applies to impermissible alterations to the vehicle.

For safety reasons, spare parts for pieces of equipment must correspond with manufacturer's instructions and be permitted by the manufacturer as a spare part. These spare parts may only be fitted by the manufacturer or an authorised specialist workshop. The authorised dealers and service centres are available for any spare parts requirement.

Here are some suggestions of important spare parts:

- Fuses
- V-belt
- Windscreen blades
- Bulbs
- Water pump (submerged pump)

When ordering spare parts please indicate the chassis number and the vehicle type to the dealer.

The vehicle described in this instruction manual is built and equipped to factory standards. Special equipment is offered depending on its purpose or use. When fitting special equipment check if such equipment has to be entered in the vehicle documents. Observe the max. permissible gross weight. The authorised dealer or service centre will be happy to advise you.

13.11 Vehicle identification plate

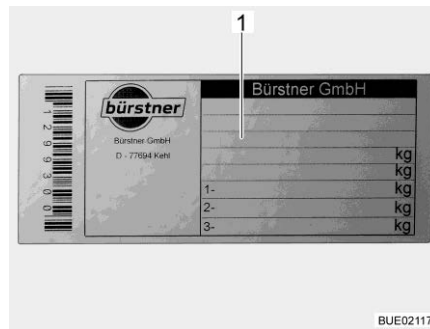

1 Chassis number

Fig. 225 Vehicle identification plate

The vehicle identification plate with the chassis number is located inside in the entrance area.

Do not remove the vehicle identification plate (Fig. 225). The vehicle identification plate:

- Identifies the vehicle
- Helps with the procurement of spare parts
- Together with the vehicle documents identifies the vehicle owner



- ▷ Always include the **chassis number** with all inquiries for the customer service office.
- ▷ The chassis number of the base vehicle is located under a cover in the entrance at the passenger side for vehicle with passenger's door, for vehicles without passenger's door under a cover on the right hand side next to the front passenger's seat.

13.12 Warning and information stickers

There are warning and information stickers on and inside the vehicle. Warning and information stickers are for the sake of safety and must not be removed.



- ▷ Replacement stickers can be obtained from an authorised dealer or a service centre.

Chapter overview

This chapter contains instructions regarding the tyres of the vehicle.

At the end of the chapter there is a table you can use to find the correct tyre pressure for your vehicle.

14.1 General



- ▶ Check tyre pressure before a journey or every 2 weeks. Wrong tyre pressure causes excessive wear and can lead to damage or even to tyre burst. You can lose control of the vehicle (see section 14.7).



- ▷ Check the tyre pressure on cold tyres. Do not reduce the higher tyre pressure when the tyres are warm.
- ▷ Tubeless tyres have been installed on the vehicle. Never install tubes in these tyres.
- ▷ Read the instruction manual for the base vehicle.



- ▷ Depending on the model, the vehicle may only be equipped with a tyre repair kit as standard.
- ▷ In the case of a puncture, pull the vehicle over to the side of the road. Make vehicle safe with a hazard warning triangle. Switch on the warning lights.
- ▷ Tyres on vehicles with tandem axles may wear faster.
- ▷ Tyres should not be older than 6 years because the material will become brittle over time. Have the tyres inspected after 6 years. The four-digit DOT number on the tyre flank indicates the date of manufacture. The first two digits designate the week, the last two digits the year of manufacture.

Example: **0719** Week 07, year of manufacture 2019.

- Observe:**
- Check the tyres regularly (every 2 weeks) for equal tread wear, tread depth and external damage.
 - Replace tyres at the latest, when the minimum depth of tread stipulated by law is reached.
 - We recommend always using tyres of the same model, same brand and same version (summer and winter tyres).
 - Only use tyres approved for the wheel rim type fitted. The permitted rim and tyre sizes are quoted in the vehicle documents and the authorised dealer or service centre will always be glad to give you advice.
 - Run-in new tyres for approx. 100 km (60 miles) at low speed since only then do they reach full strength.

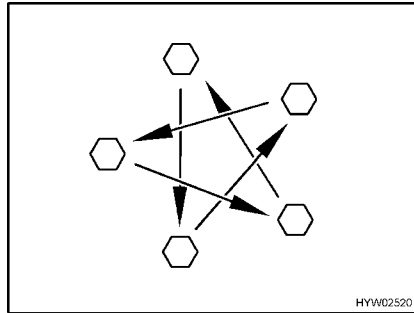

Fig. 226 Tighten the wheel nuts or wheel bolts cross-wise

- Check regularly that the wheel nuts or wheel bolts are firmly seated. Re-tighten the wheel nuts or wheel bolts of a changed wheel after 50 km (30 miles) (Fig. 226).
For tightening torque see section 14.5.2.
- When using new or newly painted rims, re-tighten the wheel nuts or wheel bolts once again after approx. 1,000 to 5,000 km (600 miles to 3,000 miles) (Fig. 226).
- For lay-ups or long periods of inactivity of the vehicle, keep the tyres and tyre bearings free from pressure points: Jack up the vehicle so that the wheels do not bear any load, or move the vehicle every 4 weeks in such a way that the position of the wheels is changed.

14.2 Tyre selection



- ▶ A wrong tyre can damage the tyres during the journey and even cause it to burst.



- ▷ If tyres that are not approved for the vehicle are used, then the type approval for the vehicle and subsequently the insurance coverage can lapse. The authorised dealer or service centre will be happy to advise you.

The tyre sizes approved for the vehicle are given in the vehicle documents or can be obtained from the authorised dealers or service centres. Each tyre must fit the vehicle on which it will be driven. This applies to the external dimensions (diameter, width), which are indicated with the standardised size designations. In addition, the tyres must meet the requirements of the vehicle with regard to weight and speed.

Weight refers to the maximum permissible axle load which can be distributed on two tyres. The maximum load-carrying capacity of a tyre is indicated by its load index (= LI, load index code).

The maximum permissible speed for a tyre (with full load-carrying capacity) is indicated by the speed index (= SI). Together, load index and speed index form the operating code of a tyre. This is an official component of the complete, standardised dimensions description which appears on every tyre. The information on the tyres must correspond to the specifications which appear in the vehicle papers.

14.3 Tyre specifications

215/70 R 15C
109/107 Q (example)

Description	Explanation
215	Tyre width in mm
70	Height-to-width proportion in percent
R	Tyre design (R = radial)
15	Rim diameter in inches
C	Commercial (transporter)
109	Load index code for single tyres
107	Load index code for twin tyres
Q	Speed index (Q = 160 km/h)

14.4 Handling of tyres

- Drive over kerbs at an obtuse angle. Otherwise the flanks of the tyres may get pinched. Driving over a kerb at a sharp angle can damage the tyre and result in it getting ruptured.
- Drive over high manhole covers at a slow speed. Otherwise the tyres may get pinched. Driving over a high manhole cover at high speed can damage the tyre and result in it getting ruptured.
- Check the shock absorbers regularly. Driving with poor shock absorbers significantly increases wear.
- In the event of an uneven thread wear, contact customer service.
- Do not clean the tyres with a high-pressure cleaner. The tyres can suffer serious damage within just a few seconds and rupture as a result.

14.5 Changing wheels

14.5.1 General instructions



- ▶ The vehicle must be on level, firm ground, secure from slipping.
- ▶ Go into first gear. In the case of automatic transmission, change gear to "P" position.
- ▶ Before jacking up the vehicle firmly apply the handbrake.
- ▶ Prevent the vehicle from rolling away by blocking the opposite wheel with the wheel chocks.
- ▶ Under no circumstances jack the vehicle with the fitted supports.
- ▶ If a trailer is connected: Detach the trailer before lifting the vehicle.
- ▶ Position the vehicle jack only at the mounting points intended for this purpose. See instruction manual of the base vehicle or the information in this manual in case the information in this manual differ from the instruction manual of the base vehicle.
- ▶ Never overload the vehicle jack. The maximum permissible load is specified on the vehicle jack's identification plate.



- ▶ Use the vehicle jack only for lifting the vehicle briefly while changing the tyre.
- ▶ No persons may be in the vehicle while it is raised.
- ▶ Do not start the motor while the vehicle is jacked up.
- ▶ Whilst the vehicle is in a jacked up position, persons must not lie down under it.



- ▷ Do not damage the thread of the thread bolt or wheel bolt when changing the wheel.
- ▷ Tighten the wheel nuts or wheel bolts cross-wise (Fig. 226).
- ▷ When changing wheels (e.g. alloy wheel rims or wheels with winter tyres), use the correct wheel bolts of the correct length and shape. Otherwise the wheels may not be securely fixed or the braking system may not work correctly.
- ▷ Wheel rims or tyres that are not approved for the vehicle can jeopardize road safety and they must be separately inspected and approved by an accredited test centre.
- ▷ Do not replace wheels cross-wise.



- ▷ Protect the vehicle according to the national regulations, e.g. with a hazard warning triangle.
- ▷ Before changing the wheel, check the wheel rim and tyre size, the max. tyre load and the speed index on the tyres. Only use the wheel rim and tyre sizes stated in the vehicle documents.
- ▷ Further information can be found in the instruction manual of the base vehicle.

14.5.2 Tightening torque

Depending on the wheel rim type and the wheel manufacturer, the wheels must be tightened with different tightening torques.

Steel wheel rims

Description	Tightening torque
16" Fiat X250 Light	170 Nm
16" Fiat X250 Maxi	170 Nm



Fig. 227 Steel wheel rim (standard)

Alloy wheel rims

Description	Tightening torque
16" Fiat X250 Light	170 Nm
16" Fiat X250 Maxi	170 Nm
18" Fiat X250 Maxi	180 Nm



Fig. 228 Fiat Light



Fig. 229 Fiat Maxi

14.5.3 Changing a wheel



- ▶ The footplate of the vehicle jack must be levelly positioned on the ground.
- ▶ Do not tilt the vehicle jack.



- ▷ The wheel you have replaced should be repaired immediately.
- ▷ Take note of the general instructions in this chapter.



Fig. 230 Securing vehicle

- Park the vehicle on as even and stable a surface as possible.
- Switch off the engine and safeguard the area.
- Engage first gear or reverse gear.
- Apply the handbrake.
- Place wheel chocks or other appropriate objects beneath the opposite wheel of the vehicle to secure it (Fig. 230).
- Remove the spare wheel from the spare wheel support.
- If the ground is soft, place a stable support such as a wooden board beneath the vehicle jack.
- Apply the vehicle jack to the designated mounting points (refer to the instruction manual for the base vehicle).
- Using the wheel brace, turn the wheel bolts several times to loosen them, but do not remove them.
- Lift the vehicle until the wheel has been lifted 2 to 3 cm above the ground.
- Remove the wheel bolts and take off the wheel.
- Place the spare wheel on the wheel hub and adjust.
- Screw in the wheel bolts and slightly tighten them cross-wise.
- Crank down the vehicle jack and remove it.
- Using the wheel brace, tighten the wheel bolts evenly (see section 14.5.2 for tightening torque).
- Have the tightening torque checked by an authorised specialist workshop.

14.6 Spare wheel support (special equipment)

The spare wheel is in the rear garage.

14.6.1 Spare wheel support in the rear garage

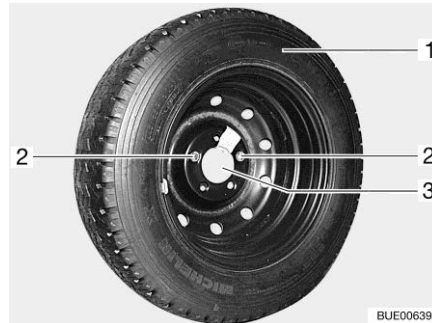

Fig. 231 Spare wheel support in the rear garage

Removing the spare wheel:

- Open external flap of the rear garage.
- Loosen and remove both fixing screws (Fig. 231,2) with the on-board tool set.
- Remove the spare wheel (Fig. 231,1) from the support (Fig. 231,3).

14.7 Tyre pressure



- ▶ Tyres overheat if the tyre pressure is too low. This can cause serious tyre damage.
- ▶ Check tyre pressure before a journey or every 2 weeks. Wrong tyre pressure causes excessive wear and can lead to damage or even to tyre burst. You can lose control of the vehicle.
- ▶ Use only valves that are approved for the specified tyre pressure.



- ▷ Check the tyre pressure on cold tyres. Do not reduce the higher tyre pressure when the tyres are warm.

The payload and the durability of tyres is directly dependent on the tyre pressure. Air is a volatile medium. It is unavoidable that it will escape from tyres.

As a rule of thumb it can be assumed that a filled tyre loses pressure at a rate of 0.1 bar every two months. To prevent the tyres becoming damaged or burst, check the tyre pressure regularly.

The contact surface of the tyre changes, depending on the tyre pressure.

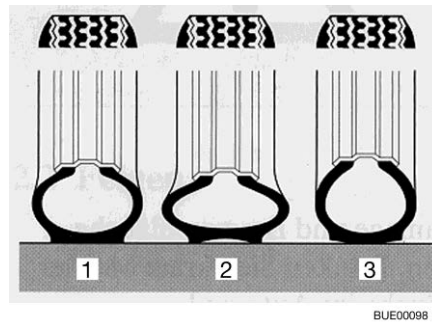

- 1 Correct tyre pressure
- 2 Tyre pressure too low
- 3 Tyre pressure too high

Fig. 232 Contact surface of the tyre



- ▷ The information on pressure levels is valid for cold tyres and loaded vehicles.
- ▷ Pressure in hot tyres must be 0.3 bar higher than in cold tyres. Recheck the pressure when the tyres are cold.
- ▷ Tyre pressures in bar.
- ▷ The tyre pressure tolerance is +/- 0.05 bar.

Description	Rim type	Type of tyres	Air pressure in bar	
			Front	Rear
16" Fiat/Light	Steel wheel rim	CP	5.0	5.5
16" Fiat/Light	Alloy wheel rim	CP	5.5	5.5
16" Fiat/Maxi	Steel wheel rim	CP	5.5	5.5
16" Fiat/Maxi	Alloy wheel rim	CP	5.5	5.5
16" Fiat/Maxi tandem axle	Steel wheel rim	CP	5.5	3.8
16" Fiat/Maxi tandem axle	Alloy wheel rim	CP	5.5	3.8
18" Fiat/Maxi	Alloy wheel rim	CP	4.8	4.8

The vehicles are constantly brought up to the newest technical standards. It is possible that new tyre sizes are not yet included in this table. If this is the case, any authorised dealer or service centre will provide the newest values.

Chapter overview

This chapter contains instructions about possible faults in your vehicle. The faults are listed with their possible causes and corresponding remedies. The specified faults can be remedied with relative ease and without a great deal of specialised knowledge. In the event that the remedies detailed in this instruction manual should not be successful, an authorised specialist workshop must find and eliminate the cause of the fault.

15.1 Braking system



- ▶ Have defects on the braking system immediately remedied by an authorised specialist workshop.

15.2 Air suspension



- ▶ Have defects on the air suspension immediately remedied by an authorised specialist workshop.

Fault	Cause	Remedy
Vehicle is at an angle	Alternation of load after switching off the air suspension	Switch air suspension on, lower it and reset the driving level
Remote control does not react	Ignition switched off	Switch on ignition
	Fuse 7.5 A is defective	Replace fuse 7.5 A
	Operating voltage too low	Charge vehicle battery
Compressor does not run	Ignition switched off	Switch on ignition
	Fuse 40 A is defective	Replace fuse
	Operating voltage too low	Charging the starter battery
Compressor does not switch off	Compressor relay is defective	Remove fuse 40 A
	Deflation	Contact a specialist workshop
Air suspension does not lower	Driving speed is too high	Observe speed limit
	Fuse is defective	Replace fuse 7.5 A
Air suspension does not lift	Vehicle too heavily loaded	Reduce load
	Driving speed is too high	Observe speed limit
	Fuse is defective	Replace fuse 7.5 A



- ▷ If the system identifies a fault, the indicator lamp will blink. A fault code can then be called up using the stop button.

See the manufacturer's operating manual for the meaning of individual fault codes.

15.3 Satellite unit

Fault	Cause	Remedy
No signal during search for satellites	No satellite found	Make sure that, towards the south, there are no obstacles in front of the satellite unit
		Make sure that the location is within the reception range of the satellite
		Make sure that the connecting cable of the signal converter (LNB) is fastened correctly on the antenna
		Make sure that all cables on the advance unit are connected correctly
Black screen	Receiver or TV set are not switched on	Switch the receiver and the TV set on
	Wrong satellite selected	Make sure that the correct satellite has been selected
The satellite unit cannot be switched on	The vehicle engine is running	Switch the vehicle engine off
	Remote control battery is empty	Change the battery
	Fuse on the supply cable is damaged	Replace fuse

Further faults can occur, which are shown by an error code on the display of the operating panel. For information on this, see the manufacturer's indications.

15.4 Electrical system



▷ When the living area battery is changed, only use batteries of the same type and the same capacity.



▷ See chapter 9 for changing the fuses.

Fault	Cause	Remedy
Road light system does no longer work correctly	Bulb is defective	Replace bulb. Note volts and watts specifications
Interior lighting does no longer work correctly	Bulb is defective	Replace bulb. Note volts and watts specifications
	Plug connector or cable defective	Contact customer service
	Fuse on the transformer/rectifier is defective	Replace fuse on the transformer/rectifier
One or several light circuits cannot be switched on	One of the voltage inputs is not supplied	Check supply from transformer/from the 12 V supply: <ul style="list-style-type: none"> • If a fuse is defective: Change the fuse • If the supply device is switched off: Switch the supply device on • If the supply device is defective: Contact customer service
	Defective cabling	Check connection cable and plugs and replace if necessary
	Defective light control	Contact customer service
No light circuit can be switched on	Battery is discharged	Charge the battery
	Defective light control	Contact customer service
Light scenes cannot be saved	Defective light control	Contact customer service
The electrically operated entrance step cannot be moved in or out	Fuse on the transformer/rectifier is defective	Replace fuse on the transformer/rectifier
"-40" or "60" flashes when the temperature display is selected	External temperature sensor or connecting cable to the external temperature sensor is defective	Contact customer service
230 V indicator lamp does not light up even though 230 V mains supply is connected	The mains connection is de-energised	Check mains connection (e.g. campsite)
No 230 V power supply in spite of connection	230 V automatic circuit breaker has triggered	Switch on 230 V automatic circuit breaker
	The mains connection is de-energised	Check the mains connection

Fault	Cause	Remedy
Starter or living area battery is not charged when operated in 230 V mode	Jumbo flat fuse (50 A) on the starter or living area battery is defective	Replace jumbo flat fuse (50 A) on the starter or living area battery
	Charger module in the transformer/rectifier is defective	Contact customer service
Living area battery is not charged during vehicle operation	Fuse on terminal D+ of the alternator is defective	Replace fuse
	Disconnecter relay in the transformer/rectifier is defective	Contact customer service
Living area battery overloaded ("hot")	Battery selection switch set wrongly	Move position of battery selection switch
	Defective load sensor or relay	Contact customer service
12 V power supply does not work	12 V power supply is switched off	Switch 12 V power supply on
	Battery cut-off switch on the transformer/rectifier switched off or battery separation activated	Switch on battery cut-off switch or deactivate battery separation via the panel
	Living area battery is discharged	Charge the living area battery
	Jumbo flat fuse (50 A) on the living area battery is defective	Replace jumbo flat fuse (50 A) on the living area battery
	Disconnecter relay in the transformer/rectifier is defective	Contact customer service
12 V power supply does not work in 230 V operation	12 V power supply is switched off	Switch 12 V power supply on
	Battery cut-off switch on the transformer/rectifier switched off or battery separation activated	Switch on battery cut-off switch or deactivate battery separation via the panel
	Charger module in the transformer/rectifier is defective	Contact customer service
	230 V automatic circuit breaker has triggered	Contact customer service
	Jumbo flat fuse (50 A) on the living area battery is defective	Replace jumbo flat fuse (50 A) on the living area battery
Starter battery is discharged in 12 V operation	Disconnecter relay in the transformer/rectifier is defective	Contact customer service
	Battery cut-off switch on the transformer/rectifier switched off or battery separation activated	Switch on battery cut-off switch or deactivate battery separation via the panel

Fault	Cause	Remedy
No voltage is supplied by the living area battery	Living area battery is discharged	Charge living area battery immediately  ▷ Total discharge damages the battery. Before the vehicle is laid up for a long period, fully charge the living area battery and then activate the battery separation/lay-up Discharging is caused by inactive appliances e.g. frost protection valve of the hot-water heater (see chapter 9)
Fault number is shown on the display after switching the panel on	Various faults in the electrical system	Narrow down the cause of the fault using the error code list in the manufacturer's instruction manual
		Contact customer service
The 12 V indicator lamp does not light up or there is no display on the panel	12 V power supply is switched off	Switch 12 V power supply on
	Battery cut-off switch on the transformer/rectifier switched off or battery separation activated	Switch on battery cut-off switch or deactivate battery separation via the panel
	Starter or living area battery is not charged	Charge the starter or living area battery
	Disconnecter relay in the transformer/rectifier is defective	Contact customer service
	Flat fuse (2 A) in the living area battery is defective	Replace flat fuse (2 A) in the living area battery

15.5 Gas system



- ▶ In case of a defect of the gas system (gas odour, high gas consumption) there is danger of explosion! Close regulator tap on the gas bottle immediately. Open doors and windows and ventilate well.
- ▶ If the gas system is defective: Do not smoke; do not ignite any open flames, and do not operate electric switches (light switches etc.). Check the tightness of gas-conducting parts and lines with leakage search spray. Do not check with an open flame.
- ▶ Have the defective gas system repaired by an authorised specialist workshop.

Fault	Cause	Remedy
No gas	Gas bottle is empty	Change gas bottle
	Gas isolator tap closed	Open the gas isolator tap
	Regulator tap on the gas bottle is closed	Open regulator tap on the gas bottle
	External temperature is too low (-42 °C for propane gas, 0 °C for butane gas)	Wait for higher external temperatures
	Built-in appliance is defective	Contact customer service

15.6 Heater/boiler

In the event of a defect contact the nearest customer service workshop of the relevant appliance manufacturer. The list of addresses is enclosed with the accompanying appliance documentation. Only authorised qualified personnel may repair the appliance.

15.6.1 Alde heater/boiler



▷ If a fault occurs in the system, the cause is shown on the display.

Fault	Cause	Remedy
Heater does not ignite with gas operation	Lack of gas	Open regulator tap and gas isolator tap
		Connect a full gas bottle
Heater does not ignite	Battery voltage too low	Charge battery. If the battery voltage rises above 11 V, the heater is switched on automatically
Heater does not ignite at 230 V electrical operation	No 230 V power supply	Switch on 230 V automatic circuit breaker
		Connect 230 V power supply
Heater switches off	Overheating	Allow the heater to cool. Disconnect and connect the 12 V power supply to the heater again to reset the indicator
Heater running, but no heat at the convectors	Circulating pump does not work	Switch on room thermostat
		Contact customer service
Heater and circulating pump running, but no heat at the convectors	Air in the heating system	Bleed hot-water heater

15.7 Air conditioning unit

15.7.1 Truma

Fault	Cause	Remedy
Air conditioning unit does not start up	No 230 V power supply	Connect the vehicle to the local power supply
	230 V automatic circuit breaker has triggered	Switch on 230 V automatic circuit breaker
Remote control is not working	Remote control batteries empty	Change remote control batteries
Air conditioning unit does not respond to remote control commands	Obstacle between remote control and IR receiver	Remove obstacle
Air conditioning unit does not cool	Temperature has been set incorrectly	Adjust the temperature
	Thermostat defective	Contact customer service
	Defrosting process is running (external temperature between 4 °C and 7 °C)	Wait until defrosting process is finished
Air conditioning unit does not warm up	External temperature below 4 °C	Heating mode not possible
	Temperature has been set incorrectly	Adjust the temperature
	Thermostat defective	Contact customer service
	Filter dirty	Change filter
	Air passages are soiled/obstructed	Clean/clear air passages
	Defrosting process is running (external temperature between 4 °C and 7 °C)	Wait until defrosting process is finished
Water is entering the vehicle	Drainage holes for condensation are clogged	Clean air conditioning unit
	Seal is defective	Contact customer service
	Inclined position	Do not drive on gradients or inclines greater than 8 %
No more air circulation	Air filter clogged	Clean air filter
	Fan wheel defective	Contact customer service

15.7.2 Telair

Fault	Cause	Remedy
Air conditioning unit does not start up	No 230 V power supply	Connect 230 V power supply
	230 V automatic circuit breaker has triggered	Switch on 230 V automatic circuit breaker
	Remote control batteries empty	Change batteries (2 x AAA)
Air conditioning unit does not cool	Room temperature is lower than the preset temperature	Reset temperature
Air conditioning unit does not heat	Room temperature is higher than the preset temperature	Reset temperature
Insufficient ventilation rating	Ventilation flaps closed	Open at least one ventilation flap
	Filter dirty	Clean the filter
Water is entering the vehicle	Drainage holes for condensation are clogged	Clean air conditioning unit

15.8 Cooker

15.8.1 Gas cooker/gas oven

Fault	Cause	Remedy
Ignition fuse does not operate (flame does not burn after the control knobs are released)	Heat-up time is too short	Keep control knob pressed for approx. 15 to 20 seconds after ignition
	Ignition fuse is defective	Contact customer service
Flame extinguishes when being reduced to its minimum setting	Thermocouple sensor is incorrectly set	Correctly reset thermocouple sensor (do not bend). The sensor tip should protrude by 5 mm beyond the burner. The sensor neck should not be more than 3 mm away from the burner ring; if necessary, contact customer service

15.8.2 Extractor hood

Fault	Cause	Remedy
Extractor hood does not work	230 V automatic circuit breaker is switched off	Switch on 230 V automatic circuit breaker
	Fuse (15 A) at the transformer/rectifier is defective	Replace fuse (15 A)
	Extractor hood is defective	Contact customer service

15.8.3 Microwave oven



► Only qualified personnel may repair the microwave oven. Improper repairs can cause major risks to the user.

Fault	Cause	Remedy
Microwave oven does not cut in	Fuse is defective	Replace fuse
	Door of the microwave oven is not properly closed	Remove foreign bodies stuck in the door of the microwave oven and close door properly

15.9 Refrigerator

15.9.1 General

In the event of a defect contact the nearest customer service workshop of the relevant appliance manufacturer. The list of addresses is enclosed with the accompanying appliance documentation. Only authorised qualified personnel may repair the appliance.



▷ Further information can be obtained in the manufacturer's instruction manual.

Fault	Cause	Remedy
Refrigerator does not re- frigerate sufficiently	Insufficient ventilation of unit	Check if ventilation grills are covered; remove co- vers if necessary
		Remove ventilation grills and clean the space be- hind them (of leaves etc.)
	Thermostat adjusted too low	Adjust higher value on thermostat
	Post evaporator heavily iced-over	Check if refrigerator door closes correctly
	Too many warm foods stored in a short period of time	Let warm foods cool down before storage
	Appliance has not been running long enough	Check again after 4 or 5 hours if the refrigerator cools
	Ambient temperature is too high	Remove the ventilation grills periodically
Refrigerator does not re- frigerate in gas operation	Lack of gas	Connect a full gas bottle
		Open regulator tap and gas isolator tap
	Air in the gas pipe	Switch appliance off and start it up again (if neces- sary, repeat procedure 3 to 4 times)
Refrigerator does not re- frigerate in 12 V operation	Fuse is defective	Replace fuse
	Battery is discharged	Check and charge battery
	Ignition switched off	Switch on ignition
	Heating element is defec- tive	Contact customer service
Refrigerator does not re- frigerate in 230 V opera- tion	Fuse is defective	Replace fuse
	No 230 V power supply	Connect 230 V power supply
	Heating element is defec- tive	Contact customer service
Refrigerator changes into gas mode in spite of mains connection	Line voltage too low	Check line voltage (refrig- erator will automatically change into 230 V opera- tion in case of correct line voltage)

15.9.2 Dometic MES/AES

In addition to the faults mentioned in section 15.9.1, the following faults can be indicated via light symbols on the Dometic refrigerator.



- ▷ In the event of a fault, the illuminated Fault button will flash. Also, either one of the illuminated buttons for operating mode or the cooling level indicator will flash. In addition, a warning signal will sound.

Fault	Cause	Remedy
LED "⚡" flashes	No 230 V power supply	Connect 230 V power supply
	230 V automatic circuit breaker has triggered	Switch on 230 V automatic circuit breaker
	230 V operating voltage too low	Have the 230 V power supply checked by an authorised specialist workshop
LED "⊕" flashes	Fuse on the transformer/rectifier is defective	Replace fuse on the transformer/rectifier
	Disconnecter relay in the transformer/rectifier is defective	Contact customer service
	12 V operating voltage too low	Have the 12 V power supply checked by an authorised specialist workshop
	No D+ signal	Contact customer service
LED "💧" flashes ¹⁾	Lack of gas	Open regulator tap and gas isolator tap Connect a full gas bottle
	Cobwebs or burnt residue in the burning chamber	Remove the ventilation grill on the outside of the vehicle and clean the burning chamber
LEDs for display of the cooling level are flashing	Temperature sensor defective	Contact customer service
LED "⚡" and LEDs for display of the cooling level are flashing	230 V heating element defective	Contact customer service
LED "⊕" and LEDs for display of the cooling level are flashing	12 V heating element defective	Contact customer service
LED "💧" and LEDs for display of the cooling level are flashing	Faulty burner or power unit	Contact customer service

¹⁾ After fixing the issue, press the illuminated button for "Fault"/"Reset".

15.10 Water supply

Fault	Cause	Remedy
Leakage water inside the vehicle	A leak has occurred	Identify leak, re-connect water pipes
No water	Water tank is empty	Replenish drinking water
	Drain cock not closed	Close drain cock
	12 V power supply is switched off	Switch 12 V power supply on
	Fuse of the water pump is defective	Replace fuse on the transformer/rectifier
	Water pump defective	Exchange water pump (have it exchanged)
	Water pipe snapped off	Straighten water pipe or replace
	Transformer/rectifier defective	Contact customer service
	Water pump switched off on panel	Switch water pump on
Toilet has no flush water	Water tank is empty	Replenish drinking water
	Fuse for toilet is defective	Replace fuse
Display for water and waste water indicates a wrong value	Measuring probe in the waste water or water tank is soiled	Clean water/waste water tank
	Measuring probe is defective	Replace measuring probe
Waste water tank cannot be emptied	Drain cock is clogged	Open the cleaning cap on the waste water tank and drain the waste water. Rinse the waste water tank well
Drain on the single lever mixer tap is clogged	Perlator calcified	De-calcify or replace perlator
Water jets on the shower nozzle clogged	Water jets calcified	De-calcify shower nozzle or rub off nozzle burling
Water drains from the shower tray slowly or does not drain at all	The vehicle is not in a horizontal position	Position the vehicle horizontally
Milkiness of the water	Tank filled with dirty water	Clean water tank mechanically and chemically; then disinfect and rinse copiously with drinking water
	Residues in the water tank or water system	Clean water system mechanically and chemically; then disinfect and rinse copiously with drinking water

Fault	Cause	Remedy
Any change in the taste or odour of the water	Tank filled with dirty water	Clean water system mechanically and chemically; then disinfect and rinse copiously with drinking water
	Fuel filled into the water tank by mistake	Clean water system mechanically and chemically; then disinfect and rinse copiously with drinking water. If not successful: Contact a specialist workshop
	Microbiological deposits in the water system	Clean water system mechanically and chemically; then disinfect and rinse copiously with drinking water
Deposits in the water tank and/or water-carrying components	Water excessively long in the water tank and in water-carrying components	Clean water system mechanically and chemically; then disinfect and rinse copiously with drinking water

15.11 Body

Fault	Cause	Remedy
Flap hinges/door hinges are difficult to operate	Flap/door hinges are not (sufficiently) lubricated	Lubricate flap hinges/door hinges with acid-free and resin-free grease
Hinges/joints in the bathroom unit/toilet compartment are difficult to operate/make a grating noise	Hinges/joints are not (sufficiently) lubricated	Lubricate hinges/joints with solvent-free and acid-free grease  ▷ Spray cans often contain solvents
Storage compartment hinges are difficult to operate/make a grating noise	Storage compartment hinges are not (sufficiently) lubricated	Lubricate storage compartment hinges with acid-free and resin-free grease
Front bonnet swivel system is difficult to operate	Front bonnet swivel system is not (sufficiently) lubricated	Lubricate front bonnet swivel system with acid-free and resin-free grease

Fault	Cause	Remedy
Electric pull-down bed does not move	Fuse on the transformer/rectifier or on the pull-down bed drive motor faulty	Replace fuse
	Living area battery is empty or the transformer/rectifier has switched off due to insufficient voltage	Charge the living area battery
	Drive is defective	In an emergency, the pull-down bed can be moved manually; afterwards, contact customer service



- ▷ The authorised dealers and service centres are available for any spare parts requirement.

16.1 Weight details for special equipment



- ▶ The use of accessories, parts and fittings not supplied by us may cause damage to the vehicle and jeopardize road safety. Even if an expert's report, a general type approval or a design certification exists, there is no guarantee for the proper quality of the product.
- ▶ Every alteration of the original condition of the vehicle can alter road behaviour and jeopardize road safety.
- ▶ No liability can be assumed for damage caused by products which have not been released by us. This also applies to impermissible alterations to the vehicle.

Weight details for special equipment available from the manufacturer are listed in the table below. If these objects are either carried in or on the vehicle and are not part of the standard equipment, they must be taken into consideration when calculating the payload.

All weight details are approximate.

Observe the max. permissible gross weight.

The table shows an extract from the list of possible special equipment and the surplus weight in each case.

Item designation	Surplus weight (kg)
Caravan coupling	50
External shower	3
Automatic transmission	17
Omni-Vent skylight	3
Extractor hood	4
Spare wheel with 16" support (rear garage)	22
External gas connection	1
Windscreen shade, electrical	9
Bike rack for 2 bicycles	9
Bike rack for 2 bicycles, lowerable	18
Bike rack for 3 bicycles	11
Bike rack for 3 bicycles, lowerable	19
Bike rack for e-bike	25
CPU remote display	1
Floor warming unit	3
Gas oven	12
Gas alarm system	1
Holder for flat screen, additionally in the rear	4
Pull-down bed, electrically adjustable	5
Air conditioning unit (Telair)	26
Air conditioning unit (Truma)	33
Fuel tank 120 l	28

Item designation	Surplus weight (kg)
Refrigerator (Tec-Tower)	40
Air suspension (3-axle vehicle)	80
Awning 600 cm	72
Microwave oven	13
Minisafe	5
Motorcycle rack	75
Multimedia system incl. reversing camera	3
Satellite unit	16
Solar installation 1 x 100 W	12
Premium sound system	3
Steadies, rear	6
Bedsread	2
Carpet in driver's cabin	3
Carpet in living area and driver's cabin	14
Winter insulation mat, outside	7
Auxiliary battery	27

Equipment packages

The equipment packages depend on the model. To calculate the additional weight, add the additional weights of the individual special equipment per package.

17.1 View of ground plans

Explanations

- (1) 230 V fuse
- (2) Transformer/rectifier with 12 V fuses
- (3) Living area battery with main fuse
- (4) Water pump
- (5) Drain cock, waste water tank
- (8) Water drain cock - yellow
- (9) Water tank
- (10) Alde hot-water heater
- (11) Compensator reservoir for Alde hot-water heater
- (12) Alde auxiliary heat exchanger
- (13) Switch for electrical drain cock, waste water tank
- * Access via service flap

Specifications without guarantee

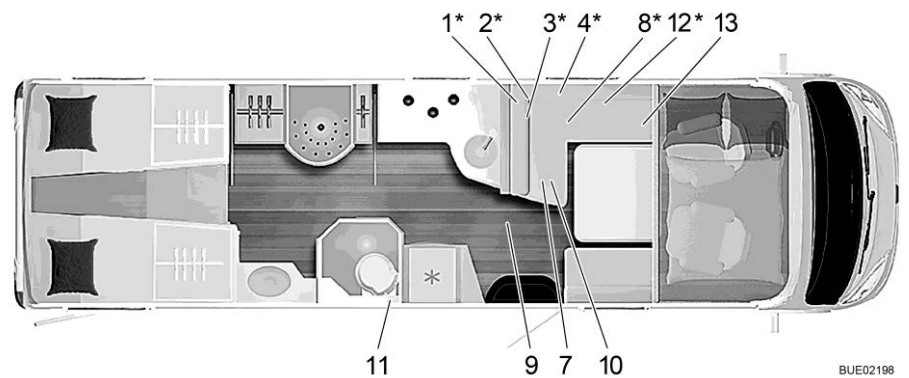

BUE02198

Fig. 233 Ground plan I 840 G Elegance

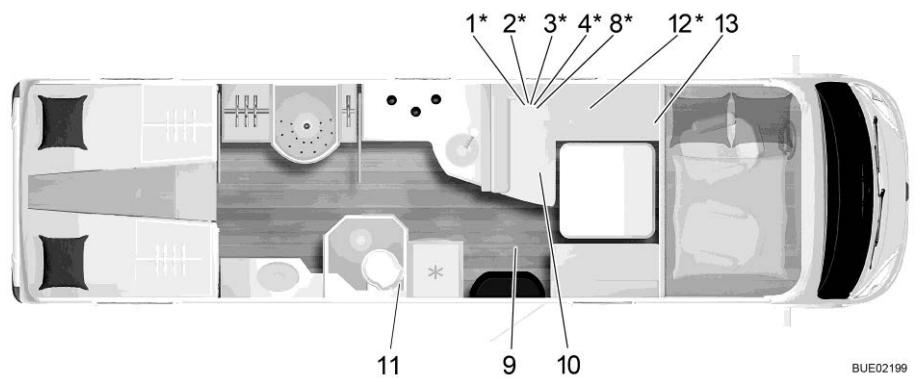

BUE02199

Fig. 234 Ground plan I 910 G Elegance

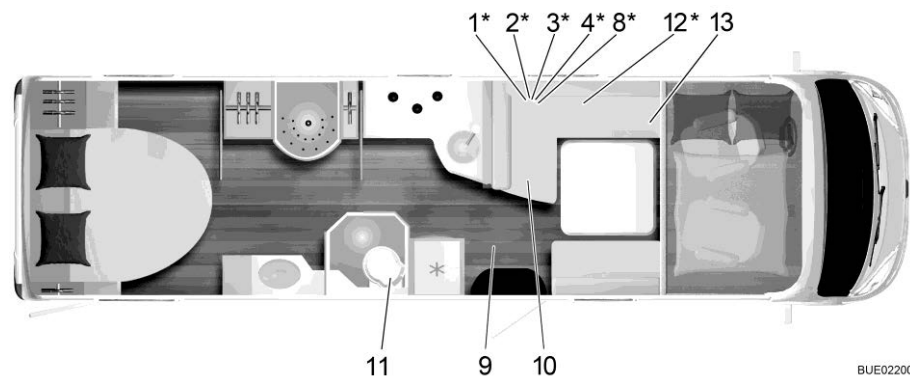

Fig. 235 Ground plan I 920 G Elegance

BUE02200

17.2 Table of linear measures / sleeping places

Type	Wheelbase in cm	Total length in cm	Body width in cm	Overall height without an- tenna in cm	Sleeping places
I 840 G	470	861	235	300	4
I 910 G	470	891	235	300	4
I 920 G	470	891	235	300	4

Chapter overview

This chapter contains helpful tips for the journey.

At the end of the chapter there is a checklist containing the most important equipment for the journey.

18.1 Traffic rules in foreign countries



- ▷ The vehicle driver is required to inform himself as to the traffic rules of the countries in which he plans to travel before beginning the trip. Contact your automobile club or embassy for further information.
- ▷ In some European countries, warning vests must be worn when exiting the vehicle outside of towns in the case of vehicle failures or accidents.
- ▷ Depending on the country, different rules and regulations apply (e.g. different warning signs for rear carriers, obligation to carry breathalyzer kits, spare bulbs, high-visibility vests, size of reserve canister). The driver of the vehicle must familiarise him or herself with these rules before every journey.
- ▷ Up-to-date information can generally be found on the web pages of the national automobile associations.

Information about traffic regulations is especially important as state law applies in case of damage. For your own safety, always observe the following rules when travelling abroad:

- Carry your insurance certificate with you.
- Always register accidents with the police.
- Never sign documents that you have not read and understood completely.

18.2 Help on Europe's roads



- ▷ Before commencing the trip, gather information on national phone numbers for rescue and police. In many countries the central emergency phone number 112 (without area code) applies.
- ▷ As far as possible, draw up a list with the important phone numbers in the travelled countries and keep the table in the vehicle.

Motoring clubs at home or in the travelled country are happy to help.

18.3 Gas supply in European countries



- ▷ In Europe, there are several different connection systems for gas bottles. It is not always possible to fill or exchange your gas bottles in a foreign country. Get information about the connection system in the country you are travelling to before embarking on your journey, e.g. at a motoring club or in the trade press.

General tips

Always observe the following instructions:

- Only go on vacation with completely filled gas bottles.
- Use all of the gas bottles' capacity.
- Take along adapter sets (available in camping supply stores) for filling gas bottles in foreign countries and for connecting the gas pressure regulator to foreign gas bottles.
- During the cold time of the year observe filling with propane gas component (butane does not gas below 0 °C).
- Use blue bottles from the firm Campingaz (distributed world-wide). Only use gas bottles with safety valves.
- When bottles from other countries are used, check the gas bottle compartments to see if the gas bottles fit into them. Gas bottles from other countries do not always display the same size as your own gas bottles.
- The web site www.mylpg.eu provides an overview of gas suppliers in Europe.

18.4 Toll regulations in European countries

Many European countries have introduced a mandatory toll system. The toll regulations and how they are collected vary greatly from country to country. Nevertheless, ignorance is no excuse. Penalties can be quite severe.

As is the case with traffic regulations, the vehicle driver is required to be familiar with the toll formalities before starting out on a trip. For example, in Austria the vignette does not meet the toll requirements for vehicles that weigh more than 3.5 t. There, a so-called "Go-Box" must be obtained and charged.

Contact your automobile club or the Internet for further information.



- ▷ Windscreens with solar filters can affect the functioning of automatic toll collection systems (e.g. Go-Box). This must be taken into account when acquiring the appropriate device (e.g. Split-Go-Box).

18.5 Tips on staying overnight safely during travel

Prudent behaviour is the most important protective measure for insuring a safe night in the motorhome.

The risk of thievery is reduced to a minimum when the following basic rules are observed:

- During high season do not spend the night at highway rest stops or parking areas located along typical vacation routes.
- Several vehicles on one site at the same time do not necessarily decrease the chances of thievery occurring. Consult your own feelings about the parking site.
- Even if it is just for one night, go to a camping site.
- When parking on open space keep emergency routes clear. The way to the driver's seat should be clear. The ignition key should always be within reach.
- Only take with you those valuables which are absolutely necessary for the journey. If possible, store valuables in a small safe and not in the immediate vicinity of windows or doors.
- Always lock up the vehicle.

18.6 Tips for winter campers

The following tips will help make your winter camping experience as agreeable as possible.

- Reserve your parking place in good time. Good winter camping sites are often booked up early.
- Do not start your trip without winter tyres.
- Bring snow chains.
- Choose your parking place with care. Observe the ground beneath you. Snow and ice may melt.
- When the vehicle has been positioned, release the handbrake to prevent freezing.
- No snow walls should be allowed to cover the built-in forced ventilation.
- Keep the built-in forced ventilation free from snow and ice.
- Make sure the air circulation is good. Good air circulation prevents moisture from collecting and makes it easier to heat the living area.
- Cover the single-paned driver's cabin window with insulation mats to avoid thermal bridges.
- Follow the instructions in the section "Gas supply in European countries".
- Use a two-bottle system with automatic controller for the gas system, so that the supply does not run out during the night.
- Only operate the gas system using propane gas.
- Do not use the space behind the heater as a storage space.
- Never operate catalytic ovens or infra-red gas radiators in the interior of the vehicle, since they consume oxygen for burning.
- Lay the 230 V power cable in such a way that the cable cannot be frozen or be damaged (e.g. during snow removal).
- When it is snowing heavily, clear the roof of the vehicle of snow regularly. A few centimetres of powdery snow serves as insulation, but wet snow quickly becomes a heavy burden.
- Before embarking on the return journey, remove all the snow from the roof to avoid impeding vehicles behind you with a "snow flag".

18.7 Travel checklists

The following checklists will help that nothing important is left at home although not everything on the checklists might be necessary.



- ▷ Do not leave checking of documents (e.g. vehicle papers and information) as well as checking the condition of the vehicle until just before commencing the trip. Planning and checking documents well in advance will save unnecessary trouble.

✓	Object	✓	Object	✓	Object
	Wiping cloth		Cleansing agent (detergent)		Salad servers
	Silverware		Dishcloths		Chopping board
	Turnspit		Glasses		Brush to wash the dishes
	Can opener		Set of knives and forks for grilling		Cloth to wash the dishes
	Ice cube tray		Corkscrew		Matches
	Lighter		Kitchen paper		Thermos jug
	Bottle opener		Garbage bags		Pots
	Air-tight storage boxes		Frying pans		
	Crockery		Stirring spoons		

Kitchen area

Bathroom/sanitary items

	Towels		Sanitary items		Toilet paper
	Hygiene products		Toilet brush		Toothbrush glass

Living area

	Dustbin		Deck of cards		Rucksack
	Road atlas		Broom		Sleeping bags
	Bath towels		Dust pan		Pencils and paper
	Bath shoes		Candles		Shoes
	Batteries		Coat-hangers		Shoe polish
	Bed linen		Clothes brush		Sports equipment
	Laundry bag		Pillow		Vacuum cleaner
	Books		Map		Flash light
	Camping guide/parking space directory		Medicine		Pocket knife
	Binoculars		Mobile phone		Table cloth
	Fire extinguisher		Sewing kit		Drinking bottle
	Gas bottle		Rain clothes		Clothes pins
	Insect lamp		First aid kit		Clothesline
	Insect repellent		Travel guide		

Vehicle/tools

✓	Object	✓	Object	✓	Object
	Waste water container		Gas tube		Snow chains (winter)
	Adapter socket		Fabric tape		Screwdriver
	CEE adapter		Watering can for drinking water		Current-measuring instrument
	Wire		Cable reel		Wheel chocks
	Spare wheel		Glue		First-aid kit
	Spare lamps		Universal pliers		Vehicle jack
	Spare fuses		Compressor		Hazard warning triangle
	Hammer		Loops		Warning sign
	Flat wrench		Tube adapter		Warning vest(s)
	Gas filling adapter		Hose clips		Flashing hazard warning light

Outside

	Stay rope		Camping table		Lock
	Bellows		Luggage racks		String
	Camping chairs		Grill		Tent pegs/tightening ropes

Documents

	List of addresses		Registration book		Passport
	Registration confirmation(s)		Driving licence		Writ of protection
	Allergy certificate		Vaccination certificate		Insurance documents
	Instruction manuals		Credit card		Vignette/toll card
	Instruction leaflets for medicines		Identity card		Visa

Pos.	Component	Activity	Interval
1	Auxiliary support	Lubrication	Annually
2	Tyres and wheel rims	Air pressure check (see section 14.7). Visual check for damage	Annually
3	Outside lighting	Function check	Annually
4	Joints, hinges	Lubrication	Annually
5	Refrigerator, heater, boiler, cooker, lighting, flap and door closures, toilet, seat belts	Function check	Annually
6	Windows, skylights	Function check, water ingress test	Annually
7	Cushions, curtains, blinds	Visual check	Annually
8	Sealing strips, edges, rubber	Check for damage	Annually
9	Water supply	Water ingress test	Annually
10	Hot-air system	Function check, clean fan wheel as necessary	Annually
11	Floor skirt attachment	Visual check	Annually
12	Pull-down bed suspension	Function check	Annually
13	Electrical system	Function check	Annually
14	Gas system	Official gas inspection	Every two years
15	Connections between the chassis and body	Check	Every two years

Delivery _____ Item 1-13	
Stamp of the Bürstner dealer	
Date	Signature

1st year _____ Item 1-13	
Stamp of the Bürstner dealer	
Date	Signature

2nd year _____ Item 1-15	
Stamp of the Bürstner dealer	
Date	Signature

3rd year _____ Item 1-13	
Stamp of the Bürstner dealer	
Date	Signature

4th year _____ Item 1-15	
Stamp of the Bürstner dealer	
Date	Signature

5th year _____ Item 1-13	
Stamp of the Bürstner dealer	
Date	Signature

6th year _____ Item 1-15	
Stamp of the Bürstner dealer	
Date	Signature

7th year _____ Item 1-13	
Stamp of the Bürstner dealer	
Date	Signature

8th year _____ Item 1-15	
Stamp of the Bürstner dealer	
Date	Signature

12 V fuses 143
 For Thetford toilet 146
 Heater for waste water pipes 146
 On the living area battery 144
 On the relay box AD01 144
 On the starter battery 143
 12 V main switch 136
 12 V power supply 127
 Switching on 136
 Troubleshooting 232
 230 V connection 71, 141
 External flap 85
 Troubleshooting 231
 230 V fuse 147
 Position 245
 230 V fuse box 147
 230 V indicator lamp 136
 230 V power supply 141
 230 V power supply see also
 230 V connection 141
 3-way valve 158

A

Accessories, fitting 16
 Actual weight 24
 AdBlue, topping up 64
 Additional equipment 25
 Add-on parts see special equipment 16
 Add-on parts, securing 40
 Air conditioning unit (Telair)
 Care 201
 Filter, cleaning 201
 Operating modes 168
 Switching off 169
 Switching on 168
 Troubleshooting 236
 Ventilation grill, cleaning 201
 Air conditioning unit (Truma) 164
 Air circulation 166
 Air distribution 165
 Automatic mode 165
 Care 201
 Cooling 166
 Filter, cleaning 201
 Heater 166
 Lighting 167
 Operating modes 164
 Remote control 164
 Soft-start 167
 Switching off 165
 Switching on 165
 Timer 167
 Troubleshooting 235

Air suspension 49
 Care 197
 Front and rear axle 50
 Functions 51
 Remote control 50
 Safety instructions 49
 Troubleshooting 229
 AL-KO rear axle 217
 Antenna alignment 75
 Automatic 73
 Appliances 153
 Manuals 16
 Armrest, adjustment 56
 Automatic power selection (AES) 176
 Awning 77

B

Basic equipment 24
 Battery alarm 138
 Battery monitor 134
 Battery see starter battery or
 living area battery 128
 Battery selector switch 133
 Battery separation 133
 Battery voltage, displaying 137
 Bed widening, securing 40
 Bed widening, single beds 113
 Beds 107
 Before the journey 23
 Bike rack
 Bicycles, loading 31, 32
 Load 30
 Lowerable 32
 Not lowerable 31
 Travelling with a loaded bike rack 30
 Blind, cleaning 198
 Blind, skylight with snap latch
 Closing 104
 Opening 104
 Boiler 154
 Boiler (Alde)
 Emptying 161
 Position 245
 Water, filling with 161
 Bonnet 61
 Closing 61
 Opening 61
 Secure 61
 Brakes 49
 Check 49, 229
 Braking system, troubleshooting 229
 Breakdown services in Europe 247



Index

Bulbs, changing	
Exterior lighting.....	212
Front lights.....	213
Halogen lamp.....	217
Interior lighting.....	216
Rear lights.....	215
Side lights.....	215
Butane gas.....	20, 116

C

Cable reel.....	141
Camping gas bottles, use.....	21, 117
Camping in winter.....	249
Cap, drinking water filler neck.....	86
Capacity of the battery.....	126
Caravan couplings.....	36
Tow ball.....	35
With detachable ball neck.....	35
Care.....	195
Air conditioning unit (Telair).....	201
Air conditioning unit (Truma).....	201
Air suspension.....	197
Blind.....	198
Carpet.....	197
Curtains.....	197
Entrance step.....	196
External care.....	195
Extractor hood.....	200
Furniture surfaces.....	197
Gas cooker.....	198
High-pressure cleaner, washing with.....	195
Hot-water heater.....	208
In the winter.....	202
Insect screen.....	198
Interior care.....	197
Lamps.....	197
Leather covers.....	197
Net curtains.....	197
PVC-floor covering.....	198
Roman shade.....	198
Seat belt.....	198
Sink.....	198
Synthetic parts, interior.....	197
Temporary lay-up.....	203
Upholstery.....	197
Washing.....	195
Waste water tank.....	200
Water pipes.....	199
Water system.....	198
Water tank.....	198
Windows.....	196
Winter lay-up.....	204
Carpet, cleaning.....	197
Central locking system.....	79
Remote control.....	79

Changing wheels.....	223
Tightening torque.....	225
Chassis number.....	219
Checklist	
Before the journey.....	43
For the journey.....	250
Initial start-up after temporary lay-up.....	206
Road safety.....	43
Temporary lay-up.....	203
Winter lay-up.....	204
Checks see checklist.....	43, 203
Child restraint systems.....	53
Children's beds.....	107, 109
Circuit diagram, exterior.....	152
Circuit diagram, interior.....	149
Circuit diagrams.....	149
Circulating pump,	
setting the rotational speed.....	158
Cleaning see care.....	195
Clipboard.....	60
Closed circuit current.....	125
Condensation.....	94, 95
Condensation on the double	
acrylic glass pane.....	95
Condensation on the screwed connections	
in the floor.....	94
Connecting cable see 230 V power supply.....	141
Conventional load.....	25
Conversion door.....	80, 81, 82
Roman shade, closing.....	82
Roman shade, opening.....	82
Unlocking.....	79
Conversion door, inside	
Locking.....	82
Opening.....	82
Cooker.....	169
Cooker see gas cooker or gas oven.....	169
Curtains, cleaning.....	197

D

Danger of suffocation.....	16, 94
Daytime running light.....	214
Dimensions see table of linear measures.....	246
Direction indicator.....	214, 215
Displays	
Battery voltage.....	137
Temperature.....	139
Waste water tank level.....	138
Water tank level.....	138
Disposal	
Household waste.....	8
Sewage.....	8
Waste water.....	8
Door lock.....	81

Doors		Exterior lighting	
Conversion door	80	Bulbs, changing	212
Driver's door	80	Check	43
Lock	81	Troubleshooting	231
Locking	79, 80	External care	195
Maintenance work	208	External connection see 230 V connection	71
Troubleshooting	241	External flaps	83
Unlocking	79	Flap lock	83, 84, 85
Drain cock, waste water tank	187	External gas connection	119
Position	245	External mirrors	59
Drain cocks, position	162, 245	Adjustment	59
Drawers		Heating	59
Closing	87	External shower	114
Opening	87	Connecting	114
Drinking water filler neck	182	Emptying	114
Closing	182	External socket	148
Opening	182	Extractor hood	174
Driver's door	80, 81	Care	200
Driver's door, inside		Filter, cleaning	200
Locking	81	Troubleshooting	237
Opening	81		
Driver's door, outside		F	
Locking	81	Fault current protection switch	141
Opening	81	Check	147
Driver's seat	55	Filling the tank	63
Armrest, adjustment	56	Fire	
Backrest, adjustment	56	Extinguishing	15
Moving to a lengthways direction	56	Response to	15
Seat inclination, setting	56	Fire prevention	15
Seat, rotating	56	Fire risks, avoidance	15
Driving speed	48	FI-switch see fault current	
Driving the vehicle	47	protection switch	147
		Fixed bed, hydraulic height-adjustable	112
E		Fixed table	
Electrical steady legs		Table leg	106
Remote control	70	Table surface, extending	106
Warning tone	69	Table top	106
Electrical system		Table top, reducing size	106
230 V connection, troubleshooting	231	Table top, shifting	106
Entrance step, troubleshooting	231	Flap lock	
Explanation of terms	125	Closing	84, 85
Lighting, troubleshooting	231	Opening	84, 85
Safety instructions	21	Square	85
Troubleshooting	231	With recessed handle	84
Emergency release	84	Flashing indicator see direction indicator	215
Entrance step	37, 67	Flat screen	93
Care	196	Positioning	93, 94
Extension	38	Storing away	93, 94
Indicator lamp	37, 38	Floor compartment	88
Retraction	38	Closing	88
Troubleshooting	231	Opening	88
Environmental tips	8	Floor warming unit, electrical	
		Overload protection	164
		Switching off	164
		Switching on	164

Index

Fog light	214
Forced ventilation	16, 94
Front passenger's seat	55
Armrest, adjustment	56
Backrest, adjustment	56
Moving to a lengthways direction	56
Seat inclination, setting	56
Seat, rotating	56
Fuel filler neck	63
Furniture flaps	86
Closing	86, 87
Opening	86, 87
Furniture flaps, troubleshooting	241
Furniture surfaces, cleaning	197
Fuse box	147
Fuses	
12 V fuses	143
230 V fuse	141, 147
For Thetford toilet	146
Heater for waste water pipes	146
On the living area battery	144
On the relay box AD01	144
On the starter battery	143
On the transformer/rectifier EBL 223	145
Fuses see 12 V fuses and 230 V fuse	143

G

Garage flap	84
Gas bottle compartment	20, 116
Gas bottles	
Safety instructions	20, 116
Gas connection, external	119
Gas cooker	
Cleaning	198
Switching off	170
Switching on	170
Troubleshooting	236
Gas isolator taps	118
Symbols	118, 153
Gas odour	19, 115, 233
Gas oven	171
Switching off	172
Switching on	172
Gas pressure regulator, screw connections	117
Gas regulator	42
Gas supply in European countries	248
Gas system	
Defect	19, 115, 233
General instructions	19
No gas	234
Safety instructions	19
Switching automatics	120
Troubleshooting	233
Ground plans	245

H

Handbrake	67
Applying	16
Handling of tyres	223
Headrests	57
Heat exchanger (Alde)	
Position	160
Shutting off	160
Starting	160
Heater	154
Heating circuit, regulating	158
Troubleshooting	234
Heater for the waste water tank and waste water pipes	188
Fuses	146
Heki skylight	102
Closing	102
Insect screen	103
Opening	102
Roman shade	103
Ventilation position	102
Help on Europe's roads	247
High rate of gas consumption	19, 115, 233
High-pressure cleaner, washing with	195
Hinged window	
Closing	97
Continuous ventilation	97
Insect screen	98
Opening	96
Roman shade	98
Holder, smartphone	60
Holder, tablet	60
Hot-water heater	
230 V electrical operation, selecting	157
3-way valve	158
Adjustment menu	156
Auxiliary circulating pump	160
Care	208
Fluid level, check	209
Gas and 230 V electrical operation, selecting	157
Gas operation, selecting	157
Heat exchangers	159
Heater, switching off	158
Heater, switching on	158
Heating fluid, topping up	209
Heating system, bleeding	210
Maintenance work	208
Operating modes	157
Operating unit	154, 155
Position	245
Rotational speed, circulating pump	158
Start screen	156
Tool menus	157

I	
Indicator lamp, 230 V power supply	136
Indicator lamp, entrance step	38
Indicator lamp, toilet	192
Information stickers	219
Inner door, troubleshooting	241
Insect screen door	
Closing	83
Opening	83
Insect screen, cleaning	198
Insect screen, Heki skylight	
Closing	103
Opening	103
Insect screen, skylight with fan	
Closing	105
Opening	105
Insect screen, window	
Closing	98
Opening	99
Inspection plan	253
Inspection time limits	207
Inspection work	207
Inspections	207
Inspections, official	207
Interior care	197
Interior lighting, bulbs, changing	216
Interior lighting, troubleshooting	231
K	
Keys	23
L	
Lamps	216
Cleaning	197
Lay-up	
During winter	204
Temporary	203
Leakage water inside the vehicle	240
Leather covers, cleaning	197
Light control	91
Light switch	91
Kitchen	89
Toilet compartment	89
Lighting	
Bulbs, changing	212
Front	213
Lamps, cleaning	197
Rear	215
Side	215
Troubleshooting	231
Living area battery	128
Battery alarm	138
Fuses	144
Instructions	128
Maintenance work	208
Position	245
Troubleshooting	232, 233
Voltage, displaying	137
Load	27
Bike rack	30
Rear garage	29
Rear storage space	29
Load rack	34
Load see also payload	27
Lock	
Conversion door	81
Driver's door	81
External flap	83, 84, 85
Furniture flap	86
Low beam	213
M	
Main beam	213
Maintenance work	208
Air conditioning unit (Telair)	201
Air conditioning unit (Truma)	201
AL-KO rear axle	217
Doors	208
Hot-water heater	208
Living area battery	208
Marker light	215
Mass in ready-to-drive condition	24, 26
Maximum permissible gross weight	24, 26
Mechanical steady legs	
Extension	68
Length, adjustment	68
Retraction	69
Microwave oven	
Switching off	173
Switching on	173
Troubleshooting	237
Monitor, reversing camera	48
Multimedia system	127
N	
Net curtains, cleaning	197
Nose weight	35
O	
Official inspections	207
Off-load voltage	125
Operating modes, air conditioning unit (Telair)	168
Operating modes, air conditioning unit (Truma)	164
Operating modes, boiler (Alde)	157
Operating modes, hot-water heater	157
Operating modes, refrigerator (Dometic)	176

Index

Oven see gas cooker or gas oven 171
Overloading 27

P

Panel (light control) 91
Panel (LT 511) 135
 12 V main switch 136
 230 V indicator lamp 136
Alarms 138
Battery displays 137
Tank display 138
Temperature display 139
Water pump switch 139
Payload 23, 24
 Calculation 26
 Composition 25
 Example calculation 25
Payload see also load 23
Permissible gross weight see maximum
permissible gross weight 23
Personal equipment 25
Pilot seat see driver's seat and front
passenger's seat 55
Propane gas 20, 116
Pull-down bed
 Access ladder 109, 111
 Lowering 108
 Raising 108
 Safety net 109
Pull-down bed, electrically operated 109
 Emergency operation 112
 Lowering 111
 Making ready for operation 111
 Overload protection 111
 Raising 111
 Safety net 111
PVC-floor covering, cleaning 198

R

Ramps 67
Rear axle load 35
Rear garage 29
Rear storage space 29
Refrigerator 71, 174
 Change-over between energy sources 176
 Door lock 179
 Frame heater 178
 Operating modes 176
 Switching on 177
 Troubleshooting 237
 Ventilation grill, removing 174
Refrigerator door locking mechanism
 Closing 180
 Locking in the ventilation position 180
 Opening 180

Refrigerator ventilation grill, removing 174
Registration 23
Remote control, air suspension 50
Remote control, central locking system 79
Remote control, electrical steady legs 70
Reversing camera 48
Risk of frost damage 21, 181
Road safety 43
 Checklist 43
 Notes for 17
Roman shade, cleaning 198
Roman shade, driver's cabin
 Closing 99
 Opening 99
Roman shade, Heki skylight
 Closing 103
 Opening 103
Roman shade, window
 Closing 98
 Opening 98
Roman shade, window of conversion door
 Closing 82
 Opening 82

S

Safety cut-out 147
Safety instructions 15
 Changing wheels 223
 Cooker 169
 Electrical system 21
 Fire prevention 15
 Road safety 17
 Towing 18
 Water system 21
Safety knob, hinged window 96
Safety net, pull-down bed 109, 111
Safety switch (FI) 147
Sanitary fittings 181
SAT socket 148
Satellite unit 72, 75
 Troubleshooting 230
 With automatic antenna alignment 73, 75
 With manual satellite selection 72
Seat belts 53
 Cleaning 198
 Correct fastening 53
Seat heater 57
Seating arrangement 58
Serial number 219
Sewage tank
 Emptying 193
 Removal 193
 Retaining clip 193

Shade, skylight with fan		
Closing.....	105	
Opening	105	
Shades for windscreen, driver's window		
and front passenger's window.....	60	
Shelves, dashboard.....	60	
Shower	190	
Shower connection point, external shower.....	114	
Shower partition, securing.....	40	
Side marker light	215	
Single beds, lying surface	113	
Sink, cleaning	198	
Skylight with fan.....	104	
Aerating.....	105	
Boost function.....	105	
Closing.....	104	
Fan, switching off.....	105	
Insect screen	105	
Opening	104	
Shade.....	105	
Venting	105	
Skylight with snap latch		
Blind	104	
Closing.....	103	
Opening	103	
Skylights.....	101, 104	
Sleeping conversion,		
lying surface single beds	113	
Sliding window		
Closing.....	98	
Opening	98	
Snow chains	43	
Sockets		
External socket.....	148	
SAT socket	148	
TV socket.....	148	
USB socket.....	126	
Solar charge regulator.....	140	
Solar installation	140	
Spare parts.....	218	
Spare wheel.....	227	
Spare wheel support.....	227	
Special equipment		
Certification	7	
Description.....	7	
Safety instructions.....	16	
Weight details.....	243	
Spotlight.....	217	
Starter battery		
Battery alarm	138	
Fuses.....	143	
Loading	128	
Position.....	128	
Troubleshooting.....	232	
Voltage, displaying.....	137	
Start-up		
After a temporary lay-up.....	206	
After a winter lay-up	206	
Staying overnight, during travel.....	249	
Steady legs		
Extension.....	68	
Length, adjustment	68	
Retraction	69	
Switching automatics, gas system.....	120	
Symbols		
For notes.....	7	
Gas isolator taps.....	118, 153	
Synthetic parts in the toilet		
and living areas, cleaning.....	197	
T		
Table of linear measures.....	246	
Tables	106	
Tank alarm.....	138	
Tank lid see fuel filler neck.....	63	
Technical data	245, 246	
Television	39	
Temperature display	139	
Tightening torque, wheels.....	225	
Toilet.....	190	
Flushing.....	192	
Fuse	146	
Indicator lamp	192	
Preparation.....	191	
Troubleshooting.....	240	
Toilet compartment	190	
Light switch.....	89	
Ventilation	190	
Toll regulations in European countries.....	248	
Total discharge	126	
Towing.....	18, 65	
General instructions.....	35	
Safety instructions	18	
Towing eye, installing.....	65	
Traffic rules in foreign countries	247	
Transformer/rectifier (EBL 223).....	131	
Circuit diagram.....	149	
Functions.....	132	
Position.....	133	
Transformer/rectifier, position.....	245	
Travel checklists	250	
Travel cots suitable for children	107, 109	
Troubleshooting		
12 V power supply.....	232	
230 V connection	231	
Air conditioning unit (Telair).....	236	
Air conditioning unit (Truma).....	235	
Air suspension	229	
Battery.....	232	
Body.....	241	

Index

Braking system.....	229	Care	200
Electrical system	231	Cleaning opening	187
Entrance step.....	231	Emptying.....	188
Extractor hood.....	237	Filling level, displaying.....	138
Furniture flaps.....	241	Heater	188
Gas cooker.....	236	Troubleshooting.....	240
Gas system	233	Water pipes, cleaning.....	199
Heater	234	Water pump.....	181, 182
Inner door	241	Position	245
Lighting.....	231	Switching on and off.....	139
Living area battery.....	232	Water supply	
Microwave oven.....	237	General	181
Refrigerator	237	Troubleshooting.....	240
Satellite unit	230	Water system.....	182
Starter battery	232	Care.....	198
Toilet.....	240	Cleaning.....	198
Water supply.....	240	Disinfect	200
Tube lamp in the rear garage.....	91	Drinking water filler neck	182
TV socket	148	Emptying.....	185
Tyre change see wheels, changing.....	223	Filling.....	182
Tyre specifications	223	Safety instructions.....	21
Tyres		Water tank.....	182
Certification.....	223	Cleaning.....	198
Excessive wear.....	18, 43, 221, 227	Draining water	185
General instructions.....	221	Filling level, displaying.....	138
Handling.....	223	Overflow.....	184
Load-carrying capacity	224	Position	245
Tyre pressure	227	Water, refilling.....	184
Tyre selection	222	Weatherproof guarantee	
		Bürstner Warranty Conditions.....	11
		Proof of water ingress tests.....	13
		Vehicle data.....	13
		Water ingress test (certificates).....	14
		Weight details for special equipment.....	243
		Wheel chocks	67
		Wheel rim size	224
		Wheel rim type.....	221
		Wheel, changing.....	226
		Window winders, electrical.....	58
		Window, conversion door	
		Roman shade, closing	82
		Roman shade, opening	82
		Windows.....	95
		Insect screen	98
		Roman shade.....	98, 99
		Windows, cleaning.....	196
		Windscreen shade	100
		Closing.....	99, 100
		Emergency operation.....	101
		Opening	99, 100
		Secure	41
		Windscreen washer fluid, filling in.....	62
		Winter care	202
		Winter operation	202