

Dear Reader ...

We would like to congratulate you on the purchase of your new caravan. You have selected a top-quality vehicle which will afford you many years of enjoyment.

To enable you to always use and operate your caravan properly and easily, your Bürstner dealer will first provide you detailed instructions for all important functions when you take delivery.

This manual, as well as the instruction manuals from the appliance manufacturers are your constant travelling companions and will help answer any questions you may have regarding your caravan.

Before your first journey

Please familiarise yourself with this manual rather than relying on it strictly for reference.

Fill in the warranty cards for the appliances and special equipment in the individual instructions and send these cards to the respective manufacturers. This ensures your warranty claim for each appliance.



1	Introduction	7	5.7	Refrigerator	40
1.1	General	8	5.8	Satellite unit (special equipment)	40
1.2	Environmental tips	8	5.8.1	Equipment with automatic antenna alignment (Teleco)	40
2	Safety	11	5.8.2	Equipment with automatic antenna alignment (Oyster)	41
2.1	Fire prevention	11	6	Living	43
2.1.1	Avoidance of fire risks	11	6.1	Conversion door	43
2.1.2	Fire-fighting	11	6.1.1	Conversion door, outside	43
2.1.3	In case of fire	11	6.1.2	Conversion door, inside	44
2.2	General	12	6.1.3	Window conversion door (special equipment)	44
2.3	Road safety	13	6.1.4	Folding insect screen on the conversion door (special equipment)	44
2.4	Towing	14	6.2	External flaps	45
2.5	Gas system	14	6.2.1	Flap lock, elliptical-shaped	45
2.5.1	General instructions	14	6.2.2	Flap lock with recessed handle	46
2.6	Gas bottles	15	6.2.3	Flap lock, rectangular	47
2.7	Electrical system	16	6.2.4	Flap for toilet cassette	47
2.8	Water system	16	6.2.5	Flap for the 230 V connection, square	48
3	Before the journey	17	6.2.6	Cap for the drinking water filler neck	48
3.1	Keys	17	6.3	Furniture flaps	49
3.2	Registration	17	6.3.1	Furniture flaps with push button	49
3.3	Manoeuvring system (special equipment)	18	6.3.2	Furniture flaps with handle	49
3.4	Connecting	20	6.3.3	Furniture flaps with pressurised release	50
3.5	Caravan couplings	21	6.3.4	Furniture flaps with handle and release knob	50
3.5.1	AKS 1300 stabiliser	21	6.4	Light switch	51
3.5.2	AKS 3004 stabiliser	22	6.4.1	Entrance area	51
3.6	Caravan control system (ATC) (special equipment)	22	6.4.2	Living area	51
3.7	Detaching	23	6.4.3	Recessed light with LED	52
3.8	Payload	24	6.5	Spotlight	52
3.8.1	Terms	24	6.6	Holder for flat screen	52
3.8.2	Calculating the payload	26	6.6.1	Holder on the column	53
3.8.3	Loading the caravan correctly	27	6.6.2	Rail-mounted holder	53
3.8.4	Caravan load, nose weight and axle load	28	6.6.3	Holder in the TV cabinet	54
3.8.5	Bike rack (special equipment)	29	6.6.4	Holder in the TV compartment	54
3.9	External mirrors	31	6.7	Heating	55
3.10	TV unit (special equipment)	31	6.8	Ventilation	55
3.11	Sink cover	32	6.9	Windows	56
3.12	Securing components	32	6.9.1	Hinged window	57
3.13	Road safety	33	6.9.2	Blind and insect screen	59
4	During the journey	35	6.10	Skylights	60
4.1	Driving with the caravan	35	6.10.1	Heki skylight (mini and midi) (partially special equipment)	61
4.2	Brakes	35	6.10.2	Heki skylight (special equipment)	62
4.3	Driving in reverse	36	6.11	Tables	64
5	Pitching the caravan	37	6.11.1	Suspension table with folding leg	64
5.1	Handbrake	37	6.11.2	Swivel table	64
5.2	Wheel chocks	37	6.11.3	Suspension table and swivel table	65
5.3	Corner steadies (partially special equipment)	38	6.11.4	Lift-off table	66
5.4	Entrance step (free-standing)	39	6.11.5	Suspension table and lift-off table	66
5.5	Waste water tank, mobile (special equipment)	39			
5.6	230 V connection	40			

Contents

6.12	Beds	67	8.7.2	230 V fuse	102
6.12.1	Bunk bed	67	8.8	Thirteen-pin plug connection diagram	103
6.12.2	Fixed bed (spring release lever)	67	8.9	External socket (special equipment)	104
6.12.3	Pull-down bed, manually operated (Premio Plus and Averso Plus)	68	8.10	Circuit diagrams	105
6.12.4	Folding bed in cabinet	70	8.10.1	Circuit diagram, interior	105
6.12.5	Widening single beds (special equipment)	72	8.10.2	Circuit diagram, exterior	106
6.13	Converting seating groups for sleeping	72	9	Appliances	107
6.13.1	Bench seating group without additional cushions	74	9.1	General	107
6.13.2	Bench seating group with additional cushions	74	9.2	Heater and boiler	108
6.13.3	Bench seating group with additional cushions (angled)	75	9.2.1	Models with waste gas vent on the right-hand side of the vehicle	108
6.13.4	Bench seating group with bed widening	75	9.2.2	To heat properly	109
6.13.5	Round seating group with additional cushion (foldable)	76	9.2.3	Alde hot water heater and boiler (partially special equipment)	109
6.13.6	Round seating group without additional cushion	76	9.2.4	Trumatic S 3004/S 5004 hot-air heater	116
6.13.7	Round seating group with additional cushion	77	9.2.5	Airmix comfort package (special equipment)	119
6.13.8	Round seating group with bed widening	77	9.2.6	Ultraheat additional electric heater (special equipment)	119
6.14	Shower connection point for external shower (special equipment)	78	9.2.7	Warming unit for waste water pipes (special equipment)	120
7	Gas system	79	9.2.8	Electrical floor warming unit (special equipment)	121
7.1	General	79	9.2.9	Truma boiler (special equipment)	122
7.2	Gas bottles	80	9.2.10	Hot water source (partially special equipment)	124
7.3	Changing gas bottles	81	9.3	Air conditioning unit (special equipment)	126
7.4	Gas isolator taps	82	9.3.1	Dometic	126
7.5	External gas connection (special equipment)	82	9.3.2	Telair	128
7.6	Crash protection unit switching facility (special equipment)	83	9.3.3	Truma	129
8	Electrical system	87	9.4	Cooker	130
8.1	General safety instructions	87	9.4.1	Gas cooker	130
8.2	Terms	87	9.4.2	Gas oven (Dometic) (special equipment)	132
8.3	12 V power supply	88	9.4.3	Microwave oven (special equipment)	134
8.3.1	Power supply unit CSV 300	88	9.4.4	Extractor hood (special equipment)	135
8.4	Battery main switch	89	9.5	Refrigerator	135
8.5	Electric kit (special equipment)	89	9.5.1	Refrigerator ventilation grill	135
8.5.1	Living area battery	89	9.5.2	Operation (Dometic with manual power selection MES)	137
8.5.2	Power supply unit CSV 409	91	9.5.3	Operation (Dometic RMD with automatic power selection)	139
8.5.3	Panel LT 408	93	9.5.4	Operation (Thetford with manual power selection)	143
8.5.4	Connection diagrams	95	9.5.5	Operation (Thetford with automatic power selection)	145
8.6	230 V power supply	97	9.5.6	Refrigerator door locking mechanism	148
8.6.1	230 V connection	98			
8.6.2	Connecting the 230 V power supply	98			
8.7	Fuses	99			
8.7.1	12 V fuses	99			

10	Sanitary fittings	151	12.3.1	General	174
10.1	Water supply, general	151	12.3.2	AKS 1300	174
10.2	Water system	152	12.3.3	AKS 3004	174
10.2.1	Water tank 22 l with external flap (special equipment)	152	12.4	Manoeuvring system	175
10.2.2	Water tank 25 l/40 l (partially special equipment)	153	12.5	Braking system	175
10.2.3	Filling the water system	154	12.6	Doors	175
10.2.4	Emptying the water system	155	12.7	Alde hot-water heater	176
10.3	Waste water installation	156	12.7.1	Checking the fluid level	176
10.3.1	Waste water tank (special equipment)	156	12.7.2	Topping up heating fluid	177
10.3.2	Warming unit of waste water pipes (special equipment)	156	12.7.3	Bleeding the heating system	177
10.4	Toilet compartment	157	12.8	Replacing bulbs, external	178
10.5	Toilet	157	12.8.1	Front lights	179
10.5.1	Preparing toilet	158	12.8.2	Rear lights	179
10.5.2	Swivel toilet	159	12.8.3	Side lights	180
10.5.3	Toilet with fixed seat	159	12.8.4	Types of bulbs for exterior lighting	180
10.5.4	Emptying the sewage tank	160	12.9	Replacing bulbs, internal	181
11	Care	161	12.9.1	Ceiling lamp	181
11.1	External care	161	12.9.2	Recessed light with LED	182
11.1.1	General	161	12.9.3	Spotlight with flexible arm	182
11.1.2	Washing with a high-pressure cleaner	161	12.9.4	Halogen spotlight (swivelling)	182
11.1.3	Washing the vehicle	162	12.9.5	Surface mounted light	183
11.1.4	Windows of acrylic glass	162	12.10	Spare parts	183
11.1.5	Hot galvanized chassis	163	12.11	Vehicle identification plate	184
11.1.6	Underbody	163	12.12	Warning and information stickers	184
11.1.7	Manoeuvring system	163	13	Wheels and tyres	185
11.2	Interior care	164	13.1	General	185
11.3	Water system	165	13.2	Tyre selection	186
11.3.1	Cleaning the waste water tank	165	13.3	Tyre specifications	186
11.3.2	Cleaning the water tank	165	13.4	Handling of tyres	187
11.3.3	Cleaning the water pipes	166	13.5	Changing wheels	187
11.3.4	Disinfecting the water system	166	13.5.1	General instructions	187
11.4	Extractor hood	167	13.5.2	Tightening torque	188
11.5	Air conditioning unit	167	13.5.3	Changing a wheel	189
11.5.1	Dometic	167	13.5.4	Changing wheels in case of alloy wheel rims	191
11.5.2	Telair	167	13.6	Spare wheel support	191
11.5.3	Truma	168	13.6.1	Spare wheel support in gas bottle compartment	191
11.6	Winter care	168	13.6.2	Spare wheel support under the vehicle (special equipment)	192
11.6.1	Preparations	168	13.7	Tyre pressure	192
11.6.2	Winter operation	169	14	Troubleshooting	195
11.6.3	At the end of the winter season	169	14.1	Chassis	195
11.7	Lay-up	169	14.2	Braking system	195
11.7.1	Temporary lay-up	169	14.3	Caravan control system (ATC)	196
11.7.2	Winter lay-up	171	14.4	Manoeuvring system	197
11.7.3	Starting up the vehicle after a temporary lay-up or after lay-up over winter	172	14.5	Electrical system	197
12	Maintenance	173	14.6	Gas system	198
12.1	Inspection work	173	14.7	Cooker	199
12.2	Maintenance work	173	14.7.1	Gas cooker/gas oven	199
12.3	Stabilisers	174	14.7.2	Microwave oven	199
			14.8	Heater, boiler and hot water source	200
			14.8.1	Truma S hot-air heater	200

14.8.2	Truma boiler	200
14.8.3	Truma hot water source	201
14.8.4	Alde heater/boiler	201
14.9	Refrigerator	202
14.9.1	General faults	202
14.9.2	Dometic	203
14.9.3	Thetford	204
14.10	Air conditioning unit	204
14.10.1	Dometic	204
14.10.2	Telair	205
14.10.3	Truma	205
14.11	Water supply	206
14.12	Body	207
15	Special equipment	209
15.1	Weight details for special equipment	209
16	Technical data	211
16.1	Table of linear measures	211
16.2	Power supply	211
17	Helpful notes	213
17.1	Traffic rules in foreign countries	213
17.2	Help on Europe's roads	213
17.3	Speed limits	215
17.4	Driving with low beam in European countries	217
17.5	Sleeping in the vehicle away from camping areas	217
17.6	Gas supply in European countries	219
17.7	Toll regulations in European countries	220
17.8	Tips on staying overnight safely during travel	220
17.9	Tips for winter campers	220
17.10	Travel checklists	221
18	Inspection plan	223

Please read this instruction manual completely before using the vehicle for the first time!

Always keep this instruction manual in the vehicle. Also inform all other users of the safety regulations.



- ▶ The non-observance of this symbol can lead to personal injury.



- ▷ The non-observance of this symbol can lead to damage being caused to, or inside the vehicle.



- ▷ This symbol indicates recommendations or special aspects.



- ▷ This symbol indicates actions which lead to environmental awareness.

This instruction manual contains sections which describe model-specific equipment or special equipment. These sections are specially marked. It may be that your vehicle has not been fitted with this special equipment. In some cases, the actual equipment of your vehicle may therefore be different from that shown in some illustrations and descriptions.

However, your vehicle may be fitted with other special equipment not described in this instruction manual.

Special equipment is described when an explanation is required.

Adhere to the instruction manuals which are separately enclosed.



- ▷ The details "right", "left", "front" and "rear" always refer to the vehicle in direction of travel.
- ▷ All dimensions and weight details are "approximate".

Should the vehicle be subjected to damage due to a failure to follow the instructions in this instruction manual, then the guarantee claim is deemed invalid.

Our vehicles are subjected to continuous development. Please understand that we reserve the right to alter the form, equipment and technology. Therefore, no claims can be made against the manufacturer as a result of the contents of this instruction manual. The equipment which was known and included at the time of going to press is described.

The reprinting, translation and copying, including extracts is not permitted without prior written authorisation from the manufacturer.



- ▷ The vehicle comes without a wheelbrace and vehicle jack. We suggest you obtain a commercially available wheelbrace before you first use your caravan, in case of an emergency. If no AL-KO vehicle jack (special equipment for AL-KO chassis) is present, obtain a conventional commercial scissor-type jack or an hydraulic vehicle jack, in order to have it ready in the case of mishap or emergency. Our authorised dealers and service centres will be happy to advise you.

1.1 General

The vehicle is constructed in accordance with the latest technology and the recognised safety regulations. Nevertheless, personal injury may result and the vehicle may be damaged if the safety instructions in this instruction manual are not followed.

Only use the vehicle in a technically impeccable condition. Follow the instructions in the instruction manual.

Malfunctions which impair the safety of persons or the vehicle should be immediately remedied by qualified personnel.

Have the vehicle's braking and gas systems inspected and repaired by an authorised specialist workshop only.

Alterations to the body are only to be carried out with the authorisation of the manufacturer.

Luggage and accessories may only be transported up to the maximum permissible gross weight.

Observe the test and inspection periods stipulated by the manufacturer.

1.2 Environmental tips



- ▷ Be considerate of the environment.
- ▷ Remember that: All kinds of waste water and household waste are not to be disposed of in drains or in the open countryside.
- ▷ On board, collect waste water only in the waste water tank or – if necessary – in other containers designed for that purpose.
- ▷ Only empty the waste water tank and toilet cassette or sewage tank at disposal stations at the camping or caravan sites, which are especially provided for this purpose. When stopping in towns and communities, observe the instructions at caravan sites or ask where there are disposal stations.
- ▷ Empty waste water tank as often as possible, even when it is not completely full (hygiene).
If possible, flush out waste water tank and, if necessary, drainage pipe with fresh water every time it is emptied.
- ▷ Never allow the toilet cassette or sewage tank to become too full. Empty the toilet cassette or sewage tank frequently, at the latest as soon as the level indicator lights up.
- ▷ Separate household waste according to glass, tin cans, plastic and wet waste also when on a journey. Enquire at the town or community authority about disposal points. Household waste is not to be disposed of in waste paper baskets which are situated at car parks.
- ▷ Empty waste bins as often as possible into the containers provided for this purpose. This helps to avoid unpleasant smells and an accumulation of rubbish on board.
- ▷ When parked, do not allow the engine of the towing vehicle to run more than necessary. When running idle, a cold engine releases more contaminants than usual. The running temperature of the engine is achieved more quickly whilst the vehicle is in motion.



- ▷ Use an environmentally-friendly WC chemical agent for the WC which can also be biologically degraded and only use small doses.
- ▷ When staying in towns and communities for long periods, search for parking areas which are specially reserved for caravans and towing vehicles. Enquire at the town or community authority about parking spaces.
- ▷ Always leave the parking places in a clean condition.

Chapter overview

This chapter contains important safety instructions. The safety instructions are for the protection of persons and property.

The instructions address the following topics:

- fire prevention and what to do in case of fire
- general care of the vehicle
- road safety of the vehicle
- towing
- gas system of the vehicle
- electrical system of the vehicle
- water system of the vehicle

2.1 Fire prevention

2.1.1 Avoidance of fire risks



- ▶ Never leave children in the vehicle unattended.
- ▶ Keep flammable materials clear of heating and cooking appliances.
- ▶ Halogen lamps can get very hot. When the light is switched on, there must always be a safety distance of 30 cm between light and flammable objects. Fire hazard!
- ▶ Never use portable heating or cooking appliances.
- ▶ Only authorised qualified personnel may make changes to the electrical system, gas system or appliances.

2.1.2 Fire-fighting



- ▶ Always carry a dry powder fire extinguisher in the vehicle. The fire extinguisher must be approved, tested and close at hand.
- ▶ The fire extinguisher is not included in the scope of delivery.
- ▶ Have the fire extinguisher tested at regular intervals by authorised qualified personnel. Observe the date of testing.
- ▶ Always keep a fire blanket near the cooker.

2.1.3 In case of fire



- ▶ Evacuate all passengers.
- ▶ Cut off the electrical power supply and disconnect from the mains.
- ▶ Close regulator tap on the gas bottle.
- ▶ Sound the alarm and call the fire brigade.
- ▶ Fight the fire if this is possible without risk.



- ▷ Acquaint yourself with the position and operation of the emergency exits.
- ▷ Keep escape routes clear.
- ▷ Observe the fire extinguisher instructions for use.

All windows and doors which meet the following requirements are considered as emergency exits:

- Open to the outside or can be shifted in horizontal direction
- Opening angle at least 70°
- Minimum diameter of clearance = 450 mm
- Maximum distance from the vehicle floor = 950 mm

2.2 General



- ▶ The oxygen in the vehicle interior is used up by breathing and the use of gas operated appliances. That is why the oxygen needs to be replaced on a constant basis. For this purpose, forced ventilation systems (e.g. skylights with forced ventilation, mushroom-shaped vents or floor vents) are installed in the vehicle. Never cover or block forced ventilations from the inside or outside with objects such as e.g. a winter mat. Keep forced ventilations clear of snow and leaves. There is a danger of suffocation due to increased CO₂ levels.
- ▶ Observe the headroom of the doors.



- ▷ As far as the appliances (heater, cooker, refrigerator, etc.) are concerned, the instruction manuals are authoritative. It is imperative that they be observed.
- ▷ Fitting accessories or special equipment can alter the dimensions, weight and road behaviour of the vehicle. Some of the parts must be entered in the vehicle papers.
- ▷ Only use wheel rims and tyres which are approved for the vehicle. Information concerning the size of the approved wheel rims and tyres is included in the vehicle documents or can be obtained from authorised dealers and service centres.
- ▷ Firmly apply the handbrake when parking the vehicle.



- ▷ When leaving the vehicle, it is imperative that all doors, external flaps and windows are closed.
- ▷ The vehicle may only be driven by drivers who hold a driving licence which is valid for the respective vehicle class.
- ▷ When selling the vehicle, hand over all instruction manuals for the vehicle and the fitted appliances.

2.3 Road safety



- ▶ Before commencing the journey, carry out a functional check of indicating and lighting equipment and the brakes.
- ▶ If the vehicle has been stationary for a long period (approx. 10 months) have the braking and gas systems checked by an authorised specialist workshop.
- ▶ Before commencing the journey, secure the pull-down bed.
- ▶ Before commencing the journey, store the television securely.
- ▶ Before commencing the journey, place and secure the flat screen and screen support in the initial position. If the screen holder is installed in a TV cabinet: Close TV cabinet.
- ▶ Carefully store all moving parts and all loose objects before starting your journey.
- ▶ During the journey, no persons are to travel inside the caravan.
- ▶ In case of underpasses, tunnels or similar obstacles, note the total height of the vehicle (including the roof load).
- ▶ In winter, the roof must be free of snow and ice before commencing the journey.
- ▶ Before commencing the journey, empty the waste water tank.
- ▶ Check tyre pressure before a journey or every 2 weeks. Wrong tyre pressure causes excessive wear and can lead to damage or even to tyre burst. You can lose control of the vehicle (see section 13.7).



- ▷ Before commencing the journey, distribute the payload evenly within the vehicle (see chapter 3).
- ▷ When loading the vehicle and when taking a rest from driving, in order to load luggage or food, for example, observe the maximum permissible gross weight and axle loads (refer to vehicle documents).
- ▷ Do not exceed the maximum permissible nose weight on the caravan coupling and do not let the weight fall below the minimum nose value. Load the caravan accordingly.
- ▷ While driving with your caravan, the towing vehicle must be equipped with two external mirrors.
- ▷ Before commencing the journey, ensure that all cupboard doors, the toilet compartment door and all drawers and flaps are secure. Engage the refrigerator door securing device.
- ▷ Before commencing the journey, close windows and skylights.
- ▷ Before commencing the journey, close all external flaps and lock them.
- ▷ Before commencing the journey, remove the external supports and retract the corner steadies or steady legs, which are fitted to the vehicle.
- ▷ Before commencing the journey, crank the jockey wheel up as far as possible.
- ▷ Before commencing the journey, put the antenna in park position.
- ▷ During the initial journey and each time after changing a wheel, re-tighten the wheel bolts/wheel nuts after 50 km (30 miles). Subsequently inspect them at regular intervals in order to ensure that they are firmly seated.
- ▷ Tyres should not be older than 6 years as the material becomes brittle over time (see chapter 13).

2.4 Towing



- ▶ Care is to be taken when connecting and detaching a trailer. Risk of accident and injury!
- ▶ No persons are to be between the towing vehicle and the trailer during positioning for connecting and detaching.

2.5 Gas system

2.5.1 General instructions



- ▶ Before commencing the journey, when leaving the vehicle or when gas equipment is not in use, close all gas isolator taps and the main isolator tap on the gas bottle.
- ▶ All gas-operated devices (heater, cooker, oven, grill, refrigerator - depending on the equipment) must be switched off for refuelling, on ferries or in the garage. Danger of explosion!
- ▶ Do not use gas-operated devices in closed spaces (e.g. garages). Danger of poisoning and suffocation!
- ▶ Only have the gas system maintained, repaired or altered by an authorised specialist workshop.
- ▶ Have the gas system checked by an authorised specialist workshop according to the national regulations before commissioning. This also applies for not registered vehicles. For modifications to the gas system have the gas system immediately checked by an authorised specialist workshop.
- ▶ The gas pressure regulator and exhaust gas pipes must also be inspected. The gas pressure regulator has to be replaced after 10 years at the latest. The vehicle owner is responsible for seeing that this is carried out.
- ▶ In case of a defect of the gas system (gas odour, high gas consumption) there is danger of explosion! Close regulator tap on the gas bottle immediately. Open doors and windows and ventilate well.
- ▶ If the gas system is defective: Do not smoke; do not ignite any open flames, and do not operate electric switches (light switches etc.). Do not check tightness of gas-conducting parts and pipes with an open flame.
- ▶ Only the stipulated devices may be connected to internal connections. Do not operate any device outside the vehicle if it is connected to an internal connector.
- ▶ Before using the cooker make sure that there is sufficient ventilation. Open a window or the skylight.
- ▶ Do not use the gas cooker or gas oven for heating purposes.
- ▶ If there are several gas devices, each gas device must have its own gas isolator tap. If individual gas devices are not in use, close the respective gas isolator tap.
- ▶ Ignition safety valves must close within 1 minute after the gas flame has extinguished. A clicking sound is audible. Check function from time to time.
- ▶ The built-in gas devices are exclusively meant for use with propane or butane gas or a mixture of both. The gas pressure regulator as well as all built-in gas devices are designed for a gas pressure of 30 mbar.



- ▶ Propane gas is capable of gasification up to $-42\text{ }^{\circ}\text{C}$, whereas butane gas gasifies at $0\text{ }^{\circ}\text{C}$. Below these temperatures no gas pressure is available. Butane gas is unsuitable for use in winter.
- ▶ Regularly inspect the gas tube fitted to the gas bottle connection for tightness. The gas tube must not have any tears and must not be porous. Have the gas tube replaced by an authorised specialist workshop no later than ten years after the manufacturing date. The operator of the gas system must see to it that the parts are replaced.
- ▶ Due to its function and construction, the gas bottle compartment is a space which is open to the exterior. Never cover or block up the standard forced ventilations. Otherwise gas that is emitted can not be diverted to the outside.
- ▶ Secure the gas bottle compartment against unauthorised access. To do this, lock the compartment.
- ▶ The regulator tap on the gas bottle must be accessible.
- ▶ Only connect gas-operated devices (e.g. gas grill) which have been designed for a gas pressure of 30 mbar.
- ▶ The exhaust gas pipe must be fitted tightly to the heating system and to the vent and must be sealed. The exhaust gas pipe must not show any evidence of damage.
- ▶ Exhaust fumes must be able to escape into the atmosphere unhindered and fresh air must be able to enter unhindered. For this reason, keep the exhaust pipe and intake openings clean and unobstructed (e.g. free from snow and ice). For this reason, no snow walls or aprons may lie against the vehicle.

2.6 Gas bottles



- ▶ Gas bottles are only to be transported within the designated gas bottle compartment.
- ▶ Place the gas bottles in vertical position in the gas bottle compartment.
- ▶ Fasten the gas bottles so that they are unable to turn or tilt.
- ▶ Connect the gas tube to the gas bottle without tension.
- ▶ If the gas bottles are not connected to the gas tube, always place the protective cap on top.
- ▶ Close the regulator tap on the gas bottle before the gas pressure regulator or gas tube are removed from the gas bottle.
- ▶ Use your hands only to connect the gas pressure regulator or the gas tube to the gas bottles. Do not use any tools.
- ▶ Only use special gas pressure regulators with a safety valve designed for vehicle use. Other gas pressure regulators are not permitted and cannot meet the demanding requirements.
- ▶ Use the gas pressure regulator defroster if the temperature falls below $5\text{ }^{\circ}\text{C}$.
- ▶ Use only 11 kg or 5 kg gas bottles. Camping gas bottles with built-in check valve (blue bottle with max. 2.5 or 3 kg content) are can be used in exceptional cases with a safety valve.
- ▶ Use the shortest possible tube lengths (150 cm max.) for external gas bottles.
- ▶ Never block the floor ventilation openings below the gas bottles.

2.7 Electrical system



- ▶ Only allow qualified personnel to work on the electrical system.
- ▶ Prior to carrying out work on the electrical system, switch off all devices and lights, disconnect the battery and disconnect the vehicle from the mains.
- ▶ Only use original fuses with the stipulated values.
- ▶ Only replace defective fuses when the cause of the defect is known and has been remedied.
- ▶ Never bridge or repair fuses.

2.8 Water system



- ▶ Water left standing in the water tank or in the water pipes becomes undrinkable after a short period. Therefore, before each use of the vehicle, thoroughly clean the water pipes and the water tank. After each use of the vehicle completely empty the water tank and the water pipes.
- ▶ In the case of lay-ups lasting more than a week disinfect the water system before using the vehicle (see chapter 11).



- ▷ If the vehicle is not used for several days or if it is not heated when there is a risk of frost, empty the entire water system. Make sure that the 12 V power supply on the panel is switched off. Otherwise, the water pump will overheat and may get damaged. Leave the water taps on in central position. Leave the safety/drainage valve (if there is one) and all drain cocks open. Frost damage to appliances, frost damage to the vehicle and deposits in water-carrying components can be avoided in this way.

Chapter overview

This chapter contains important information which has to be noted before commencing your journey or carrying out any tasks before the journey.

The instructions address the following topics:

- keys
- registration
- manoeuvring system
- coupling on towing vehicle
- stabiliser
- caravan control system
- uncoupling from towing vehicle
- calculating the payload
- correct loading of the caravan
- external mirrors
- storing the television
- securing components

At the end of the chapter there is a checklist which once again summarises the most important points.

3.1 Keys



Fig. 1 Keys

Two keys (Fig. 1) are included with the caravan.

The keys fit the:

- Conversion door
- Service flaps
- Toilet flap
- Gas bottle compartment flap

Always deposit a replacement key outside the vehicle. Make a note of the key number. Our authorised dealers and workshops can offer assistance in case of loss.

3.2 Registration

Your caravan is a vehicle which must be registered. Observe national regulations on registration.

Please remember that certain countries require a separate national code sticker in addition to the EU plate.

3.3 Manoeuvring system (special equipment)



- ▶ No persons are to remain inside the caravan while it is being manoeuvred.
- ▶ No persons (in particular children) are to remain inside the manoeuvring area while manoeuvring.
- ▶ In the event of malfunctions, apply the handbrake.
- ▶ Do not use the manoeuvring system as a handbrake.
- ▶ Store the remote control in a safe place inaccessible to children.
- ▶ Always swivel the drive rollers away from the tyres before commencing a journey. If the drive rollers are swivelled onto the tyres during the journey, the tyres could burst.



- ▷ Before manoeuvring, check the tyres and drive rollers and if necessary, remove any sharp stones or similar objects.
- ▷ When manoeuvring on a slope, make sure the drawbar is facing downhill. This will prevent the vehicle from tilting backwards.
- ▷ Do not store sensitive devices like cameras or DVD players directly next to the control device or the cable. The manoeuvring system generates electromagnetic fields that can damage such devices.



- ▷ When manoeuvring, the interval between the remote control and the middle of the vehicle may be a maximum of 10 meters.
- ▷ After switching off the manoeuvring system via the remote control, the control remains in stand-by mode. To shut the manoeuvring system down altogether, it must be disconnected from the battery.
- ▷ After manoeuvring is complete, pull the 13-pin plug from the safety socket. The living area battery can otherwise lose its charge.
- ▷ If both brake lights are defective, the circuit of the safety socket is not closed and the manoeuvring system will not work.

Using the manoeuvring system (Mover), the vehicle can be moved without any other aids.

Remote control



- ▷ If the remote control is switched on and **no** button is pressed for approx. 2 minutes, or a button is pressed and **held down** for approx. 7 minutes, the remote control switches itself off.
To reactivate the remote control, push the sliding switch to "OFF" (0), wait approx. 2 seconds and then push the sliding switch back to "ON" (1).

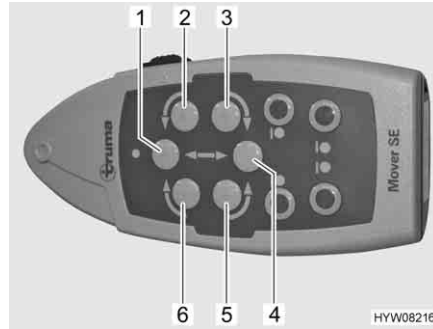

Fig. 2 Direction buttons

The vehicle is steered using the direction buttons on the remote control (Fig. 2). The following table describes the function of the individual direction buttons:

No. in Fig. 2	Movement	Function
1	Vehicle forwards	Both wheels turn forwards
2	Vehicle forwards to the left	The right wheel turns forwards
3	Vehicle backwards to the left	The right wheel turns backwards
4	Vehicle backwards	Both wheels turn backwards
5	Vehicle backwards to the right	The left wheel turns backwards
6	Vehicle forwards to the right	The left wheel turns forwards
3+6	The vehicle turns on the spot clockwise	The left wheel turns forwards and the right wheel turns backwards
2+5	The vehicle turns on the spot anti-clockwise	The left wheel turns backwards and the right wheel turns forwards

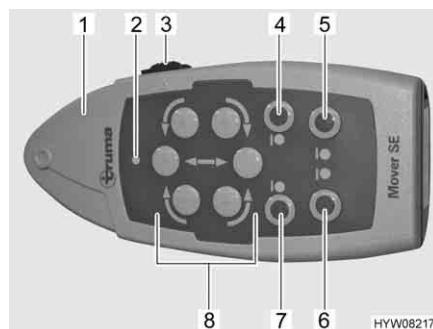

Fig. 3 Remote control

Manoeuvring:

- Detach vehicle (see section 3.7).
- Insert 13-pole plug into the safety socket of the manoeuvring system.
- Push the sliding switch (Fig. 3,3) on the remote control (Fig. 3,1) to "ON" (I). If the green LED (Fig. 3,2) lights up, the manoeuvring system is operational.
- Swivel the drive rollers onto the tyres on both sides. To do so, press the "Engage" (Fig. 3,4 and 7) buttons.
- Release the handbrake and remove the wheel chocks.
- Move the vehicle into the required position using the direction buttons (Fig. 3,8).

- Apply the handbrake again (see section 5.1).
- Swivel the drive rollers away from the tyres on both sides. To do so, press the "Disengage" (Fig. 3,5 and 6) buttons.
- Push the sliding switch (Fig. 3,3) on the remote control to "OFF" (0).



- ▷ Further information can be obtained in the manufacturer's instruction manual.

3.4 Connecting



- ▶ Care is to be taken when connecting and detaching a trailer. Risk of accident and injury!
- ▶ No persons are to be between the towing vehicle and the trailer during positioning for connecting and detaching.
- ▶ Observe the permissible nose weight and rear axle load of the towing vehicle. Refer to the vehicle documents for the values of rear axle load.
- ▶ Ensure that the interior of the coupling is not soiled and that the movable parts of the coupling (not the ball retainer) are lubricated.
- ▶ The tow ball is not to be lubricated when using a stabiliser. The friction pads are pressed against the coupling ball and thereby generate an anti-rolling moment. This anti-rolling effect is only guaranteed when the towing vehicle coupling head is free of lubricant and other residues. When lubricating the stabiliser ensure that no lubricant is on the friction pads.
- ▶ If the caravan coupling is removable, secure the breakaway brake cable to the eye of the caravan coupling (if present). Otherwise the caravan will not be slowed down if the removable caravan coupling breaks away.



- ▷ Caravan with an overrun brake: Do not connect or detach caravan with the overrun brake on.
- ▷ Caravan coupling with detachable ball neck: If the ball neck is mounted incorrectly, there is the danger of the trailer breaking away. Observe the instruction manual for the caravan coupling.
- ▷ Do not climb onto the drawbar covering – risk of breakage!
- ▷ In order to connect the vehicle, crank the supporting jockey wheel down and set it down on the ground.
- ▷ Do not use the stabilising lever of the stabiliser as a maneuvering aid.



- ▷ Check whether the caravan's connector plug fits into the socket of the towing vehicle. If connector plug and socket do not match, ask your authorised dealers and workshops for adapting options.
- ▷ Further information about the stabiliser can be obtained in the manufacturer's instruction manual.

- Connecting:*
- Connect the caravan (see section 3.5). The coupling jaw and the ball must interlock and are not to be loosely superposed. The coupling jaw must completely surround the ball.
 - Connect the breakaway brake cable with a loop to a suitable anchorage point on the vehicle. If the caravan coupling is removable, also secure the breakaway brake cable to the eye of the caravan coupling. Thereby, observe the cable length: The cable must not trail on the ground or trigger the braking function around corners.
 - Crank the jockey wheel up as far as possible. Adjust the running role in parallel to the direction of travel and to the draw box.
 - Insert the connector plug of the caravan in the socket of the towing vehicle. Ensure that the hooks of the safety cover engage with the plug. The hooks prevent the plug from becoming loose during the journey.
 - Put the connection cable in a loose loop across the drawbar. Make sure that it does not touch the ground.
 - Check whether the caravan coupling is mounted correctly on the coupling ball. Pay attention to the safety indicator.
 - Check whether corner steadies and jockey wheel are raised.
 - Check the caravan lighting system whilst the towing vehicle is connected.

3.5 Caravan couplings



- ▷ Before connecting, ensure that the tow ball of the coupling device is free of dirt and grease.

3.5.1 AKS 1300 stabiliser

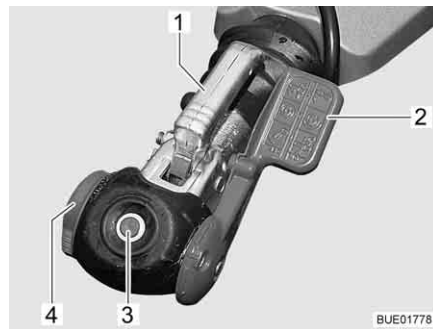

Fig. 4 AKS 1300 stabiliser

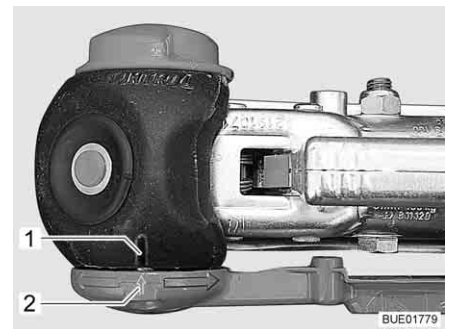

Fig. 5 Check "AKS closed"

- Connecting:*
- Pull up the stabilising lever (Fig. 4,2) as far as possible.
 - Turn the handwheel (Fig. 4,4) in an anticlockwise direction as far as possible in the open position.
 - Pull the coupling handle (Fig. 4,1) upwards.
 - Place the opened stabiliser on the caravan coupling. The coupling handle must audibly lock back into its initial position.
 - In addition, push the coupling handle downwards by hand (not with your foot). Closing and securing is carried out automatically.

- Conduct a visual inspection: The green cylinder on the safety indicator (Fig. 4,3) must be visible.
- Turn handwheel in a clockwise direction until it can be felt and heard that the torque limiting mechanism grates.
- Push the stabilising lever down until the marking on the stabilising lever (Fig. 5,2) is aligned with that on the stabilising housing (Fig. 5,1).

3.5.2 AKS 3004 stabiliser

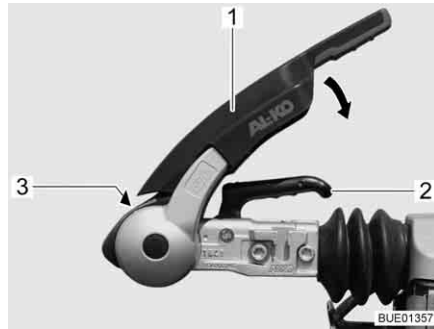

Fig. 6 AKS 3004 stabiliser



Fig. 7 Check "AKS closed"

Connecting:

- Pull up the stabilising lever (Fig. 6,1) as far as possible.
- Pull the coupling handle (Fig. 6,2) upwards.
- Place the opened stabiliser on the caravan coupling. The coupling handle must audibly lock back into its initial position.
- In addition, push the coupling handle downwards by hand (not with your foot). Closing and securing is carried out automatically.
- Conduct a visual inspection: The green cylinder on the safety indicator (Fig. 6,3) must be visible.
- Activate the stabilising device. Push the stabilising lever (Fig. 6,1) down to its stop limit.
- Conduct a visual inspection: The arrow (Fig. 7,2) must point to "2" (Fig. 7,1).

3.6 Caravan control system (ATC) (special equipment)



- ▶ The steady plus on the connection socket on the towing vehicle must be protected with 15 A or 20 A fuses. Fire hazard!
- ▶ The caravan control system cannot override the physically preset limits. Do not exceed the maximum speed of 100 km/h intended by the designers, and always adapt your speed to suit the weather, road and traffic conditions.



- ▷ Also read the manufacturer's instruction manual.



1 Control LED

Fig. 8 Control LED

- Couple caravan.
- Use the connection cable to connect the caravan to the towing vehicle. The caravan control system starts a self test. The control LED (Fig. 8,1) on the caravan lights up red for about 3 seconds.
- Check whether the control LED lights up green after the self test. The caravan control system is now active.

3.7 Detaching



- ▶ Care is to be taken when connecting and detaching a trailer. Risk of accident and injury!
- ▶ In addition, observe the safety instructions with respect to connecting included in this instruction manual.



- ▷ Do not climb onto the drawbar covering – risk of breakage!

Detaching:

- Apply the caravan handbrake.
- Place the wheel chocks behind both of the wheels.
- Remove the connector plug of the caravan from the towing vehicle socket and insert it in the holder on the drawbar.
- Remove the breakaway cable from the towing vehicle.
- Crank the jockey wheel down until it is set firmly on the ground. Now loosen the caravan coupling.
- Using the jockey wheel, lift the drawbar until the towing vehicle can be driven away without risk.

3.8 Payload



- ▶ Overloading the vehicle and wrong tyre pressure can cause tyres to burst. You can lose control of the vehicle (see section 13.7).
- ▶ The permissible total weight and the weight including special equipment fitted at the factory (actual weight) is shown in the vehicle documents, but not the weight of the loaded vehicle (see section 3.8.1). For your own safety, we recommend that you have your loaded vehicle (with all luggage and personal objects) weighed on a public weighbridge before you set out on your journey.



- ▷ Do not exceed the maximum permissible gross weight (permissible total weight) stated in the vehicle documents and the maximum axle loads as a result of the payload.
- ▷ Built-in accessories and special equipment reduce the payload.
- ▷ Adhere to the axle load stated in the vehicle documents.

Load the caravan so that the drawbar coupling head is not loaded above the permissible nose weight on the coupling head. The heavy objects should be close to the axles to create a weight centre in the middle of the vehicle.

When loading the caravan observe:

- The towing vehicle's maximum permissible caravan load
- The maximum permissible nose weight (e.g. 50 kg)
- The minimum nose weight of 25 kg

This information is in the towing vehicle operating manual.

Maximum permitted payloads

Description	Load (kg)
Roof load	90
Bunk beds	100
Pull-down bed	200
Bike rack	Double 35

3.8.1 Terms



- ▷ Technically speaking, the term "mass" has now replaced the term "weight". However, "weight" is still the term more frequent in common use. For better understanding, "mass" is therefore only used in the following sections for fixed formulations.
- ▷ All specifications according to EU norm DIN EN 1645-2.

Maximum permissible gross weight in a laden condition

The maximum permissible gross weight in a laden condition is the weight that a vehicle may never exceed.

The maximum permissible gross weight in a laden condition consists of the **actual weight** and the **payload**.

In the vehicle documents, the manufacturer has specified the maximum permissible gross weight in a laden condition.

Actual weight

The actual weight consists of the mass in ready-to-drive condition and the weight of the special equipment fitted at the factory.

Mass in ready-to-drive condition

The mass in ready-to-drive condition is the weight of the ready-to-drive standard vehicle (excluding special equipment fitted at the factory).

The mass in ready-to-drive condition is made up as follows:

- Unladen weight (mass of the empty vehicle) with factory-installed standard equipment
- Basic equipment weight

Basic equipment includes all equipment and fluids required for safe and proper vehicle use. The weight of the basic equipment includes:

- A full fresh water system
- A gas bottle filled up to 100 %
- A full heating system
- A full toilet flushing system
- The power cables for the 230 V power supply
- The installation kit for an auxiliary battery if an auxiliary battery can be used

The waste water and sewage tanks are empty.

Example for calculating the basic equipment

Water tank with 25 l	25 kg
Aluminium gas bottle (11 kg _{gas} + 5.5 kg _{bottle})	+ 16.5 kg
230 V power cable	+ 4 kg
Total	= 45.5 kg

The mass in ready-to-drive condition and the actual weight are shown in the vehicle documents.

Payload

The payload is made up as follows:

- Additional equipment
- Personal equipment

You will find explanations on the individual components of the payload in the following text.



- ▷ The vehicle's payload can be increased by reducing the actual weight. To do this, it is allowed for example to empty the fluid containers or to remove the gas bottles.

Additional equipment

Additional equipment includes accessories and special equipment. Examples of additional equipment include:

- Spare wheel
- Bike rack
- Satellite unit
- Microwave oven
- Hot water supply

Chapter 15 lists the weights of the various items of special equipment; they may also be obtained from the manufacturer.

Personal equipment

Personal equipment includes all items in the vehicle that are not included in the additional equipment. For example, personal equipment can include the following:

- Foodstuffs
- Crockery
- Television
- Radio

- Clothes
- Bedding
- Toys
- Books
- Toiletries

No matter where kept, personal equipment also includes:

- Bikes
- Boats
- Surfboards
- Sports equipment

For the personal equipment, according to the applicable regulations, the manufacturer must use a minimum weight that is determined according to the following formula:

Formula Minimum weight M (kg) = 10 x N + 10 x L

Explanation N = maximum number of beds, as stated by the manufacturer
L = total length of the caravan in metres, not including the drawbar

Example Caravan with 4 beds and a length of 5 m:
Minimum weight M (kg) = 10 x 4_{beds} + 10 x 5_{metres} = 90 kg

3.8.2 Calculating the payload



- ▶ The payload calculation at the factory is partly based on all-inclusive weights. For safety reasons, the maximum permissible gross weight in a laden condition must not be exceeded.
- ▶ The permissible total weight and the weight including special equipment fitted at the factory (actual weight) is shown in the vehicle documents, but not the weight of the loaded vehicle (see section 3.8.1). For your own safety, we recommend that you have your loaded vehicle (with all luggage and personal objects) weighed on a public weighbridge before you set out on your journey.

The payload (see section 3.8.1) is the difference in weight between

- Maximum permissible gross weight in a laden condition and
- of the actual weight.

Example for calculating the payload

	Mass in kg to be calculated	Calculation
Maximum permissible gross weight according to vehicle documents	1500	
Actual weight including basic equipment as per the vehicle documents	- 1200	
This results in a permissible payload of	300	

The calculation of the payload from the difference between the maximum permissible gross weight when loaded and the actual weight specified by the manufacturer is however only a theoretical value.

Only if the vehicle is weighed with full tanks, full gas bottles and complete additional equipment on a public weighbridge, can the actual payload be determined.

The actual payload is the difference between the maximum permissible gross weight in laden condition and the weighed vehicle weight.

The result is the weight that is permitted for the actual load of the personal equipment.

3.8.3 Loading the caravan correctly



- ▶ Never exceed the maximum permissible gross weight.
- ▶ Distribute the load evenly on the left and right sides of the vehicle.
- ▶ Store all objects in such a way that they cannot slip.
- ▶ Store heavy objects (awning, tin cans, etc.) close to the axles. Low-lying storage spaces whose doors do not open in the direction of travel are particularly suited for storing heavy objects.
- ▶ Stack light objects (laundry) in the roof storage cabinets.
- ▶ Never concentrate the caravan load at the rear.

The payload arrangement recommended cannot be adhered to consequently as the storage facilities are to be found throughout the complete caravan. Ensure that heavy items are close to the axles and the lower area, i.e. directly above the vehicle floor. Store heavy objects (awning, tin cans, etc.), if possible, in the towing vehicle.

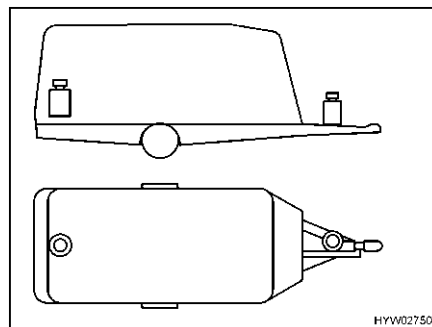

Fig. 9 Incorrect weight distribution

Incorrectly loaded

Loads stored apart from each other (Fig. 9) lead to inclination to skid.

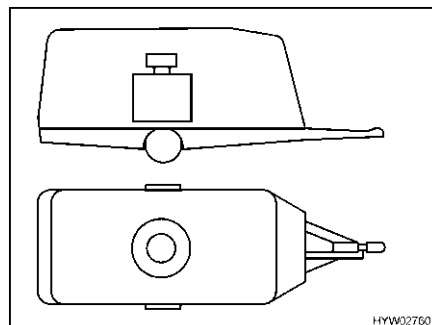

Fig. 10 Correct weight distribution

Correctly loaded

Do not store heavy objects such as awnings, tin cans, etc. in the caravan but rather in the towing vehicle. Secure bicycles on the roof of the towing vehicle. Store all loads close to the axle (Fig. 10).

3.8.4 Caravan load, nose weight and axle load



- ▶ Always set the maximum possible nose weight.
- ▶ Always pay attention to the minimum nose weight of 25 kg.



- ▷ The nose weight of the caravan may not exceed 100 kg.



- ▷ The information on the towing vehicle documents is important for the selection of the car and caravan.

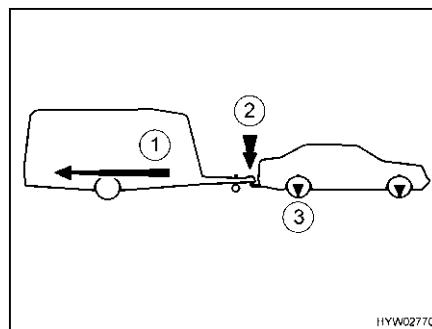

- 1 Caravan load
- 2 Nose weight
- 3 Axle load

Fig. 11 Caravan load, nose weight and axle load

Caravan load

The caravan load (Fig. 11,1) stipulated in the towing vehicle documents provides information as to the **maximum weight** which the towing vehicle is permitted to tow. The caravan load refers to the **actual** weight of the caravan and **not** to the maximum permissible gross weight of the caravan.

Example

The towing vehicle is allowed to tow 1,200 kg. If the caravan has a maximum permissible gross weight of 1,200 kg and in fact weighs 900 kg, it can be loaded with another 300 kg. If however the caravan has a maximum permissible gross weight of 1,400 kg, it may only be loaded to a maximum of 1,200 kg.

Nose weight

The nose weight (Fig. 11,2) specifies how much weight the caravan drawbar can apply to the caravan coupling of the towing vehicle. Information is to be found in description of the caravan couplings and the vehicle documents. Therefore, a caravan coupling with a maximum permissible nose weight of 50 kg must not support a loaded caravan which has an actual nose weight of 75 kg. Additionally, the nose weight must be taken into consideration for the permissible gross weight of the towing vehicle. If necessary the payload in the towing vehicle must be reduced by the amount of the nose weight.

The maximum permissible gross weight for the towing vehicle and for the caravan is not to be exceeded.

Only when the nose weight is adapted optimal to the towing vehicle and caravan combination, the towing vehicle and caravan achieves its maximum driving stability. The optimal nose weight is simultaneously the maximum possible nose weight.

- Please refer to the vehicle documents and the description of the caravan coupling for the maximum permissible nose weight.
- If different values are specified in the vehicle documents and in the description of the caravan coupling: Please select the **lowest** value. This value is the **maximum possible nose weight** for the towing vehicle and caravan.
- Check the nose weight before each journey, e.g. with a nose weighing scales. To obtain a correct value, position the nose weighing scales vertical under the coupling jaw and place the caravan drawbar horizontal.
- The payload in the caravan must be distributed in such a way that the measured nose weight comes as close as possible to the maximum permissible nose weight. The maximum permissible nose weight is not to be exceeded.

Axle load

The axle load (Fig. 11,3) is also specified in the vehicle documents of the towing vehicle and provides information concerning the permissible maximum load for the front and rear axles. The axle load may not be exceeded by a trailer. The above illustration shows where which forces act on the car and caravan.

3.8.5 Bike rack (special equipment)



- ▶ Observe the permissible axle loads and maximum permissible gross weight when loading the bike rack.
- ▶ Do not exceed the maximum permissible nose weight on the caravan coupling and do not let the weight fall below the minimum nose value. Load the caravan accordingly.
- ▶ A total width of 2.55 m must not be exceeded. Adjust the attachments for the bikes accordingly. The lateral overhang must be marked with a red flag.
- ▶ Load the bike rack with bicycles only (max. two units).
- ▶ Fasten bicycles using the straps provided and check to see that they are secure after you have driven a few kilometres.
- ▶ Check the secure attachment of the bicycles on the bike rack after the first 10 km and then at each break in the journey.
- ▶ Do not use the bike rack as luggage rack or ladder.



- ▷ The bike rack is only to be used for transporting bicycles.
- ▷ The gross weight specified by the manufacturer must not be exceeded.
- ▷ The identification plate and rear lights must not be covered.
- ▷ The maximum permissible payload of the bike rack is 35 kg.
- ▷ When loading the bike rack, observe the centre of gravity. If the bike rack is only loaded with **one** bicycle, position the bicycle as closely as possible to the vehicle wall.
- ▷ Driving with a folded out bike rack without bicycles is not permitted.
- ▷ Before every journey, check:
 - Is the bike rack without bicycles folded in correctly?
 - Are the bicycles securely fastened to the bike rack using the bike rack belts?

Front bike rack The bike rack is attached to the struts of the drawbar with the installation material.

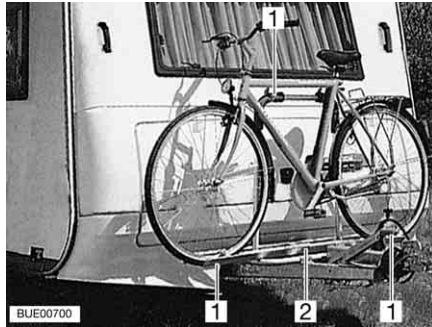

Fig. 12 Front bike rack

Loading the bicycles:

- Put the bikes on to the bike rack (Fig. 12,2) and secure them with quick straps (Fig. 12,1).

Bike rack on the rear wall Depending on the model, the bike rack is either screwed directly onto the rear wall or clipped into special brackets at the rear. Beneath the vehicle the bike rack is screwed to the floor plate.



Fig. 13 Bike rack on the rear wall

Loading the bicycles:

- Put the bikes onto the bike rack and secure them with quick straps.
- In addition, secure each bicycle on the retaining bracket or retaining arm.

3.9 External mirrors



- ▶ Before every journey, re-adjust the external mirrors on the towing vehicle for safety reasons.



- ▷ Additional mirrors must be EC-type certified and thus meet the EC guidelines.

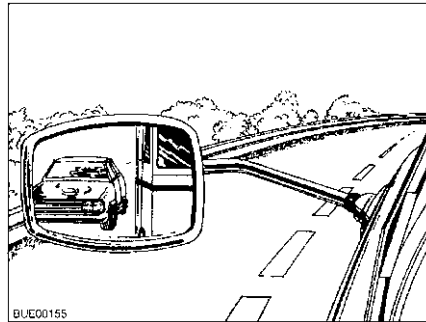

Fig. 14 External mirrors

When towing a trailer, the towing vehicle must be equipped with two external mirrors. The external mirrors ensure that the roadway next to the trailer can be clearly seen.

The following applies when purchasing additional mirrors

- If possible, take the towing vehicle and caravan with you.
- Test on site to see if they fit.
- Check that the mirror is suitable for the vehicle and the seating position of the driver.

3.10 TV unit (special equipment)



- ▶ Before commencing the journey, place and secure the flat screen and screen support in the initial position. If the screen holder is installed in a TV cabinet: Close TV cabinet.
- ▶ Before commencing the journey, ensure that the antenna is in park position. Danger of accidents! Park position means: The antenna points towards the back, is fully lowered and is locked in this position.



- ▷ Further information on positioning the flat screen can be obtained from chapter 6.

3.11 Sink cover



- ▷ If the vehicle is equipped with a fixed sink cover, close sink cover before setting off.
- ▷ If the vehicle is equipped with a removable sink cover, the sink cover may fall off the sink and damage parts of the equipment in the event of accident, emergency braking or on uneven road surfaces. Before the journey, take the sink cover off the sink and store it securely in the kitchen unit or wardrobe.

3.12 Securing components



- ▷ In the event of an accident or emergency braking, loose components could damage the equipment of the vehicle. Before setting off, secure loose components in the holders provided or stow them in a secure place inside the vehicle.
- ▷ Unsecured flaps and doors can spring open during the journey and damage parts of the interior. Secure all flaps and doors before setting off.

Inner doors and tables are examples of components. See section 6.3 for furniture flaps.



Fig. 15 Table, lowered (example)

Depending on the vehicle equipment, there are different possibilities to secure the table:

Securing strap (Averso)

If the vehicle is equipped with a L-seating group, the lowered table (Fig. 15) will be secured with a securing strap. The securing strap will be fixed with snap fasteners located under the table top and on the bench seat.

Clamp fastener (Averso)

If the vehicle is equipped with a suspension table and a swivel table/lift-off table, the lowered table (Fig. 15) will be secured with two clamp fasteners. Hook the clamp fasteners underneath the table top of the suspension table into the hooks of the swivel table/lift-off table and close them.

3.13 Road safety



- ▶ Check tyre pressure before a journey or every 2 weeks. Wrong tyre pressure causes excessive wear and can lead to damage or even to tyre burst. You can lose control of the vehicle (see section 13.7).

Before commencing the journey, work through the checklist:

Towing vehicle with caravan

No.	Checks	Checked
1	All vehicle documents are on board	
2	Two external mirrors fitted to towing vehicle	
3	Nose weight has not been exceeded or fallen below the minimum	
4	Tyres in proper condition and tyre pressure correct	
5	Road lighting system working	
6	Overrun brake functions correctly	
7	Brakes react evenly	
8	When braking, the towing vehicle and caravan remain in the lane	
9	Total height determined and noted. Keep the height information close at hand in the towing vehicle	

Housing body, outside

10	Awning completely retracted	
11	Roof free of snow and ice (in winter)	
12	External connections and lines disconnected and stored away	
13	External supports removed	
14	Corner steadies and jockey wheel cranked as high as possible	
15	Wheel chocks removed and stored away	
16	Entrance step is stored securely or retracted	
17	External flaps closed and locked	
18	Conversion door locked	

Housing body, inside

19	Windows and skylights closed and locked	
20	Television removed from the support and securely stored	
21	Flat screen secured	
22	Television antenna retracted (if one is built in)	
23	Loose parts stored away or fixed in position	
24	Open storage spaces empty	
25	Sink cover is stored securely	
26	No gas cartridges or other easily flammable materials stored in the roof cupboard of the awning light	
27	Refrigerator door secured	

No.	Checks	Checked
28	Refrigerator set to 12 V operation	
29	All drawers and flaps closed	
30	Inner doors and table secured	
31	Pull-down bed secured	
Gas system		
32	Gas bottles firmly fixed in the gas bottle compartment so that they are unable to turn	
33	If the gas bottles are not connected to the gas tube, always place the protective cap on top	
34	If there is no supplied crash protection unit: Regulator tap on the gas bottle and gas isolator taps are closed	
Electrical system		
35	<p>Check the battery voltage of the living area battery (see chapter 8). If a battery voltage is displayed on the panel which is too low then the living area battery must be re-charged. Observe the notes and instructions in chapter 8</p> <p> ▷ Commence journey with fully charged living area battery.</p>	
Water system housing body		
36	Mobile waste water tank stored away and secured in the gas bottle compartment	
37	Water system emptied in case of risk of frost. Watertaps and drain cocks open	

Chapter overview

This chapter contains instructions on how to drive the caravan.

The instructions address the following topics:

- driving speed
- brakes
- driving in reverse

4.1 Driving with the caravan



- ▶ During the journey, no persons are to travel inside the caravan.
- ▶ The caravan constructions were designed for a maximum permissible speed of 130 km/h.
- ▶ Please always observe the speed limits in the individual countries (see chapter 17).

The main differences between driving with a caravan and driving without a caravan are the increased vehicle width and length, a decreased acceleration and an increased vehicle stopping distance. Therefore, adapt your driving technique to the altered road behaviour resulting from driving with a caravan.

4.2 Brakes



- ▶ Have defects on the braking system immediately remedied by an authorised specialist workshop.

Before each journey

Before each journey, check by means of a braking test:

- Does the overrun brake function?
- Do the brakes react evenly?
- Do the towing vehicle and the caravan remain in the lane when braking?

4.3 Driving in reverse



- ▷ When driving in reverse, the caravan reacts in exactly the opposite direction to the steering movements of the towing vehicle. If you steer the towing vehicle to the left, the caravan moves to the right.
- ▷ Never back up without a second person to direct you.

As far as all models with an automatic reverse driving mechanism are concerned, the caravan can be reversed without difficulty. In addition to the rolling resistance, residual braking power must be taken into account.

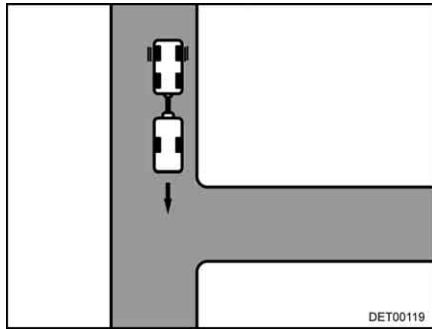

Fig. 16 Approach

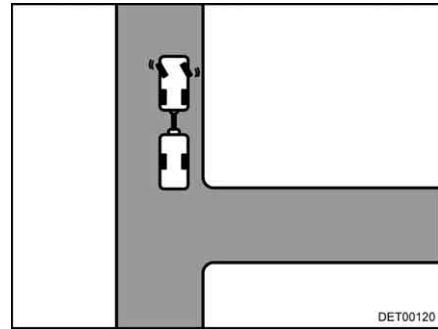

Fig. 17 Steer to the left

Driving in reverse:

- Drive up to the entrance until the rear of the caravan is roughly level with the entrance (Fig. 16).
- Steer the stationary towing vehicle and trailer to the left (Fig. 17).
- Reverse with caution. The caravan moves to the right.

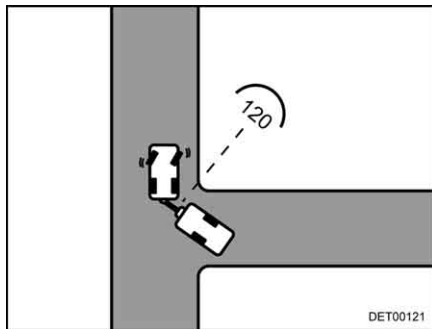

Fig. 18 Approach

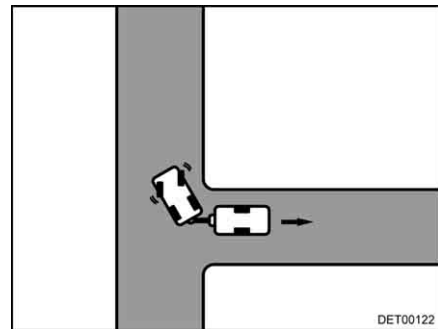

Fig. 19 Steer to the right



- ▷ The angle between the vehicles must not be too narrow, otherwise the corners will bump against each other. This can cause major damage to the vehicles. Get someone to direct you!

- As soon as both vehicles are at an approximate angle of 120° to each other, come to a stop (Fig. 18).
- Steer to the right and reverse with caution (Fig. 19).
- Continue to reverse, correcting the steering if necessary.
- For the last 2 to 3 m, steer to the left once more so that the towing vehicle and trailer are in line.

Chapter overview

This chapter contains instructions on how to pitch the vehicle.

The instructions address the following topics:

- handbrake
- wheel chocks
- operation of the supports
- entrance step
- mobile waste water tank
- 230 V connection
- refrigerator
- aligning the antenna



- ▷ Pitch the vehicle so that it is as horizontal as possible. Secure the vehicle to prevent it from rolling.

5.1 Handbrake



- ▷ Do not climb onto the drawbar covering – risk of breakage!



- ▷ If there is any risk of frost, release the handbrake every now and then and apply it again. This will prevent it from freezing or rusting. Prior to releasing the handbrake, secure the vehicle so that it cannot roll away.

Firmly apply the handbrake when parking the vehicle.



Fig. 20 Handbrake

To release it, push the handbrake (Fig. 20,1) forwards.

5.2 Wheel chocks

Use the two wheel chocks even when the upward or downward gradients are of a minimum.

5.3 Corner steadies (partially special equipment)



- ▷ Do not use the fitted corner steadies as a vehicle jack. The corner steadies are only for stabilising the pitched vehicle. The vehicle wheels are not to be raised above the ground.
- ▷ When pitching the vehicle, ensure that the corner steadies are evenly loaded.
- ▷ Before driving away, wind up the corner steadies as far as they can go.

In order to stabilise the pitched caravan use the corner steadies fitted as standard.

With the assistance of the jockey wheel position the pitched caravan in a horizontal position. For control purposes use a small spirit level.

Crank down the corner steadies after the caravan is in an absolutely horizontal position.



- ▷ When the ground is soft, place a pad or block under the supports in order to prevent the vehicle from sinking into the ground.

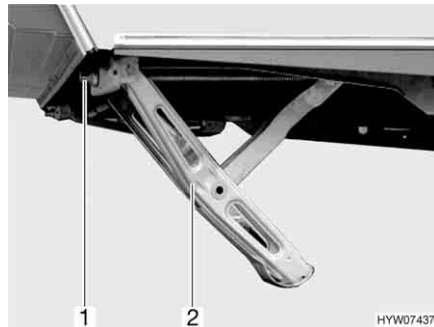

Fig. 21 Corner steady cranked down

Cranking down:

- Place the hand crank provided as standard on the hexagonal nut (Fig. 21,1) of the corner steady (Fig. 21,2).
- Rotate the hand crank in a clockwise direction. The corner steady is swung downwards.

Cranking upwards:

- Turn the crank handle in an anticlockwise direction. The corner steady is swung upwards.

5.4 Entrance step (free-standing)



- ▶ Make sure that the entrance step stands on secure and level ground. This will prevent the entrance step from toppling over.
- ▶ Do not step on the edges of the entrance step. Danger of slipping!
- ▶ Secure the entrance step to the ground, for example, with tent pegs. This way the entrance step cannot slip away.



Fig. 22 Entrance step (free-standing)

- Place the entrance step (Fig. 22,1) in front of the entrance to the caravan.

5.5 Waste water tank, mobile (special equipment)

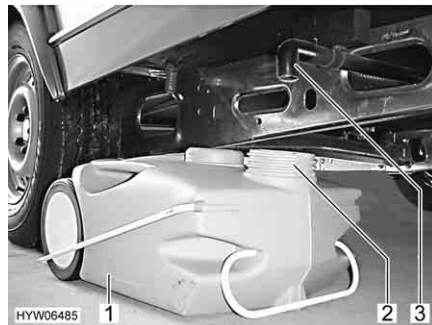

Fig. 23 Waste water tank, mobile

The waste water tank (Fig. 23,1) is stored inside the caravan gas bottle compartment during the journey. The drain pipe (Fig. 23,3) of the caravan is located at the bottom of the vehicle - on the left hand side in the direction of travel.

Before using the water system: Place the waste water tank under the caravan in such a way that the opening (Fig. 23,2) of the waste water tank is under the drain pipe.

5.6 230 V connection

The vehicle can be connected to a 230 V power supply (see chapter 8).

5.7 Refrigerator

Without electric kit, 12 V operation of the refrigerator is only possible while the towing vehicle is connected and the engine of the towing vehicle is running. When the vehicle engine is switched off, switch the refrigerator to 230 V operation or gas operation.

5.8 Satellite unit (special equipment)



- ▶ Before commencing the journey, ensure that the antenna is in park position. Danger of accidents!



- ▷ The vehicle must be still during the satellite search. Do not walk through the vehicle.
- ▷ Satellite reception is only possible, when the antenna is positioned in direct line of sight of the chosen satellite and the view is not blocked in any way.
- ▷ Further information can be obtained in the device manufacturer's instruction manual.

5.8.1 Equipment with automatic antenna alignment (Teleco)

The satellite unit is equipped with an automatic positioning unit. This automatic positioning unit ensures that the antennas are aligned accurately.

The flat screen incorporates a digital receiver.

The satellite unit is operated via remote control.



- 1 TV On/Off button
- 2 On/Off button
- 3 Function buttons

Fig. 24 Remote control

Setting up the unit:

- Switch on the television and receiver.
- Press the "On/Off" button (Fig. 24,2) on the remote control. The satellite antenna erects itself from the parked position.
- Use the function buttons (Fig. 24,3) to set the required transmitter. When the unit finds the satellite, the TV programme appears automatically.

5.8.2 Equipment with automatic antenna alignment (Oyster)



- ▶ Before commencing the journey, ensure that the antenna is in park position. Danger of accidents!



- ▷ The vehicle must be still during the satellite search. Do not walk through the vehicle.
- ▷ Satellite reception is only possible, when the antenna is positioned in direct line of sight of the chosen satellite and the view is not blocked in any way.
- ▷ Also read the manufacturer's instruction manual.

The satellite unit is equipped with an automatic positioning unit. This automatic positioning unit ensures that the antennas are precisely aligned to the desired satellites.

Operation is menu-controlled (TV screen) using the remote control.

Setting up the unit:

- Switch on the television.
- Use the mains switch to switch on the receiver. When the green LED on the receiver's infra-red receptor lights up, the receiver is ready to operate.
- Switch on the receiver with the remote control. The satellite antenna repositions itself out of the park position and into search mode.

When the system finds the satellite, the selected TV programme appears automatically.

Satellite mouse

Depending on the model, the satellite receiver is equipped with a satellite mouse. The satellite mouse's display (Fig. 25.2) shows the current channel. The two buttons can be used to operate the basic functions of the satellite unit (changing channel, switching on/off).

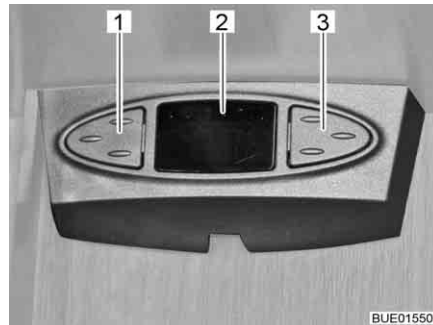

Fig. 25 Satellite mouse

Operating the satellite mouse:

- Choosing the previous channel from the list: Press left button (Fig. 25,1).
- Choosing the next channel from the list: Press right button (Fig. 25,3).
- Switching between radio and TV: Press the buttons (Fig. 25,1 and Fig. 25,3) briefly at the same time.
- Switching the receiver on/off: Press and hold the buttons (Fig. 25,1 and Fig. 25,3) at the same time.

Chapter overview

This chapter contains instructions about living in the vehicle.

The instructions address the following topics:

- opening and closing the doors and flaps
- light switches
- adjusting the spotlights
- positioning the television
- heating the vehicle
- ventilation of the vehicle
- opening and closing the windows and blinds
- opening and closing the skylights
- converting tables
- use of the beds
- use of the external shower

6.1 Conversion door



▶ Only drive with locked doors.



- ▷ Locking the doors can prevent them from opening of their own accord, e.g. during an accident.
- ▷ Locked doors also prevent forced entry, e.g. when waiting at traffic lights.
- ▷ When leaving the vehicle, always lock the doors.

6.1.1 Conversion door, outside

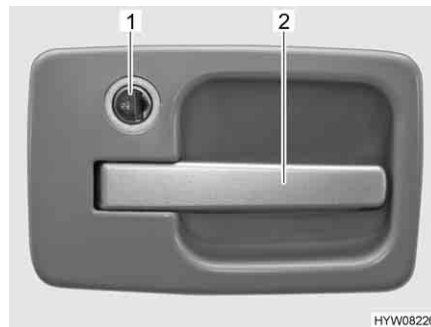

Fig. 26 Door lock of conversion door, outside

Opening:

- Insert the key into the locking cylinder (Fig. 26,1) and turn towards the "U" symbol. The door lock is unlatched.
- Return the key to the central position and remove it.
- Pull on the handle (Fig. 26,2). The door is open.

Locking:

- Insert the key into the locking cylinder (Fig. 26,1) and turn towards the "🔒" symbol. The door lock is locked.
- Return the key to the central position and remove it.



- ▷ For conversion doors with a left-hand opening, locking and opening is done in the reverse directions to those of the conversion door shown.

6.1.2 Conversion door, inside

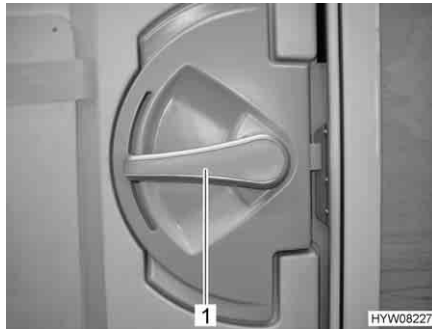

Fig. 27 Door lock of conversion door, inside

Opening:

- Push the handle (Fig. 27,1) down.

Locking:

- Turn the handle (Fig. 27,1) approx. 45° upward and leave it in this position.

6.1.3 Window conversion door (special equipment)

The conversion door window is fitted with a Roman shade.



Fig. 28 Roman shade

Closing:

- Grip the Roman shade (Fig. 28,2) in the middle of the holding bar (Fig. 28,1), pull it upwards and then release it at the desired height. The Roman shade will stay at this height.

Opening:

- Grip the Roman shade in the middle of the holding bar and push it down.

6.1.4 Folding insect screen on the conversion door (special equipment)



- ▷ Open the insect screen completely before closing the conversion door.



Fig. 29 Insect screen

Closing: ■ Pull out the insect screen completely by the bar (Fig. 29,1).

Opening: ■ Push the insect screen into its initial position by the bar (Fig. 29,1).

6.2 External flaps



- ▷ Before commencing the journey, close all external flaps and lock them.
- ▷ To open and close the external flap, open or close all locks that are fitted to the external flap.



- ▷ When leaving the vehicle, close all external flaps.

The external flaps fitted to the vehicle are all fitted with identical locking cylinders. Therefore, all locks can be opened with a single key.

6.2.1 Flap lock, elliptical-shaped



- ▷ During rain, water can penetrate the opened flap lock. Therefore close the lock handle.

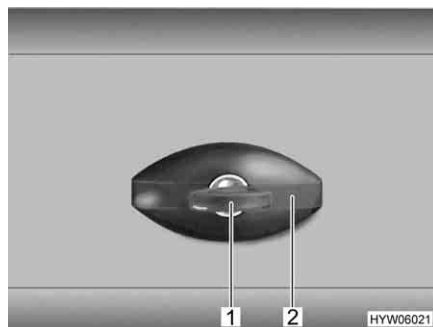

Fig. 30 Flap lock, elliptical-shaped, closed

- Opening:*
- Insert key into locking cylinder (Fig. 30,1) and turn a quarter turn in an anti-clockwise direction. The lock handle (Fig. 30,2) snaps out.
 - Remove the key.
 - Turn lock handle one quarter turn in an anticlockwise direction. The flap lock is open.

- Closing:*
- Firmly close the external flap.
 - Turn lock handle in a clockwise direction until it is horizontal. The flap lock is now engaged but not locked.
 - Insert key into locking cylinder.
 - Press down lock handle with key inserted and turn key a quarter turn in a clockwise direction. The lock handle will stay bolted.
 - Remove the key.

6.2.2 Flap lock with recessed handle



- ▷ To open the external flap, pull all the lock handles fitted to that particular external flap at the same time.

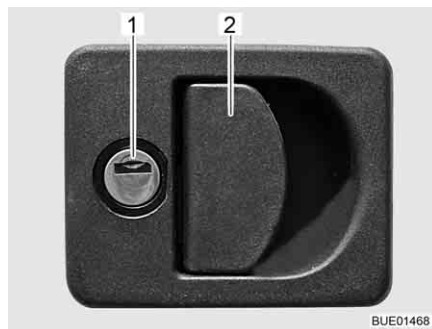

Fig. 31 Flap lock with recessed handle

- Opening:*
- Insert key into locking cylinder (Fig. 31,1) and turn a quarter turn. The flap lock is unlatched.
 - Remove the key.
 - Pull on the lock handle (Fig. 31,2). The external flap is open.
- Closing:*
- Firmly close the external flap.
 - Insert key into locking cylinder and turn a quarter turn. The flap lock is locked.
 - Remove the key.

6.2.3 Flap lock, rectangular



Fig. 32 Flap lock, rectangular, closed

- Opening:*
- Insert key into locking cylinder (Fig. 32,1) and turn a quarter turn. The lock handle (Fig. 32,2) snaps out.
 - Remove the key.
 - Turn the lock handle one quarter turn. The flap lock is open.
- Closing:*
- Firmly close the external flap.
 - Turn lock handle until it is horizontal. The flap lock is now engaged but not locked.
 - Insert key into locking cylinder.
 - Press down lock handle with key inserted and turn key a quarter turn. The lock handle will stay bolted.
 - Remove the key.

6.2.4 Flap for toilet cassette

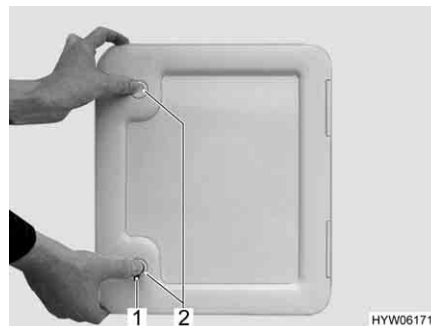
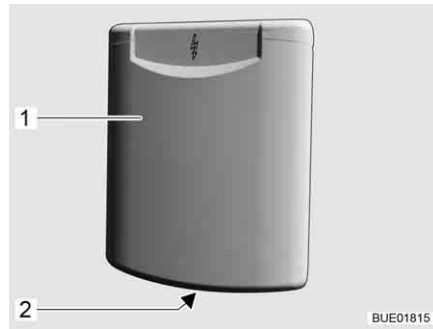

Fig. 33 Flap for toilet cassette

- Opening:*
- Insert key into locking cylinder (Fig. 33,1) of the push-button lock and turn a quarter turn.
 - Remove the key.
 - Press both push-button locks (Fig. 33,2) simultaneously with your thumb and open the flap for the toilet cassette.
- Closing:*
- Close the flap for the toilet cassette and press it shut.
 - Insert key into locking cylinder (Fig. 33,1) and turn a quarter turn.
 - Remove the key.

6.2.5 Flap for the 230 V connection, square



- 1 External flap
- 2 Recessed grip

Fig. 34 Flap for the 230 V connection

- Opening:*
- Reach into the recessed grip (Fig. 34,2) on the external flap (Fig. 34,1) and swing the external flap upward.
- Closing:*
- Swivel the external flap downwards and press it shut.

6.2.6 Cap for the drinking water filler neck

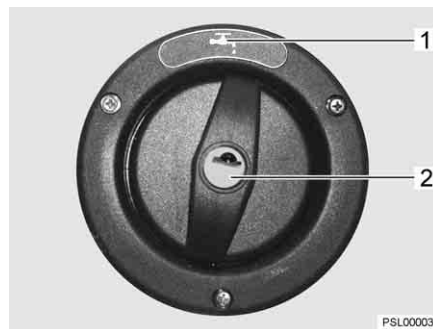

Fig. 35 Cap for the drinking water filler neck



- ▷ The drinking water filler neck is indicated by the symbol "☰" (Fig. 35,1).

- Opening:*
- Insert the key in the locking cylinder (Fig. 35,2) and turn it in an anticlockwise direction.
 - Remove cap.
- Closing:*
- Insert the cap in the drinking water filler neck.
 - Turn key in a clockwise direction.
 - Remove the key.

6.3 Furniture flaps



- ▷ Before commencing the journey, close all furniture flaps and inner doors and lock them.
- ▷ The furniture flaps shown in this section are examples. Depending on the model, the locks and handles on the furniture flaps may differ to those displayed here.

6.3.1 Furniture flaps with push button



Fig. 36 Furniture flap with push button (round)



Fig. 37 Furniture flap with push button (square)

- Opening:*
- Press inner part of the lock. The push button jumps out (Fig. 36 or Fig. 37).
 - Hold push button and open furniture flap.
- Closing:*
- Press furniture flap shut.
 - Press push button in until it locks. The furniture flap is closed correctly when the fastener locks into place.

6.3.2 Furniture flaps with handle

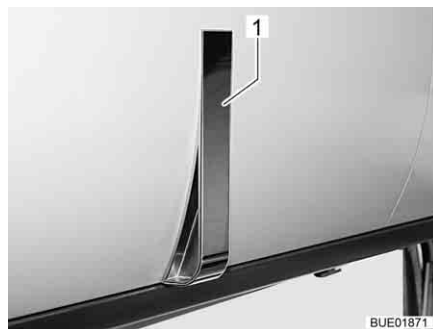

Fig. 38 Furniture flap with handle (example)

- Opening:*
- Pull handle (Fig. 38,1) until furniture flap is open.
- Closing:*
- Push down furniture flap until flap hinge perceptibly closes.

6.3.3 Furniture flaps with pressurised release

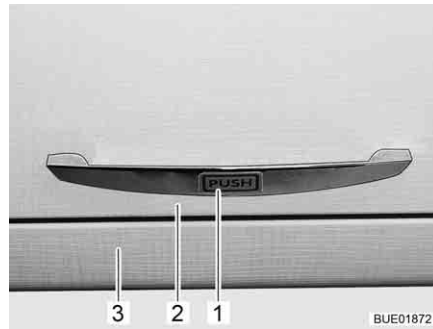

Fig. 39 Furniture flap with pressurised release

- Opening:*
- Press the furniture flap (Fig. 39,2) with the handle (Fig. 39,1) against the cabinet body (Fig. 39,3). The furniture flap is unlocked.
 - Open furniture flap.
- Closing:*
- Press furniture flap shut until the latch audibly engages.

6.3.4 Furniture flaps with handle and release knob

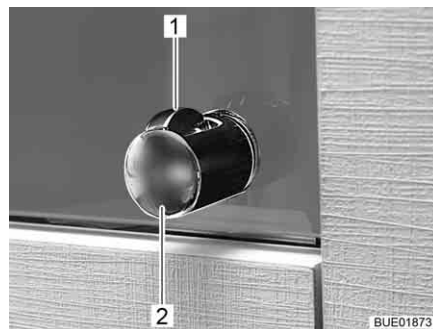

Fig. 40 Handle with release knob

- Opening:*
- Press the release knob (Fig. 40,1) and hold it down.
 - Pull the handle (Fig. 40,2) until the furniture flap is open.
- Closing:*
- Press furniture flap shut until the latch audibly engages.

6.4 Light switch

6.4.1 Entrance area



▷ The light switches shown in this section are examples. Depending on the model, the type and allocation of the light switches may differ to those displayed here.

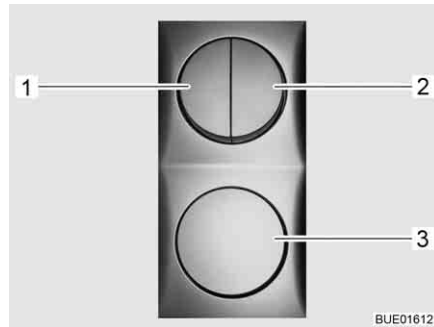

Fig. 41 Light switch



Fig. 42 Awning light

The entrance area has light switches (Fig. 41,1-3) for the following lamps:

- Entrance lights
- Awning lights
- Living area lights

6.4.2 Living area



▷ The lamps shown in this section are examples. Not all lamps used in the vehicle are shown. The examples are intended to clarify the possible positions for the light switches. The type and appearance of the light switches can deviate from those shown here.

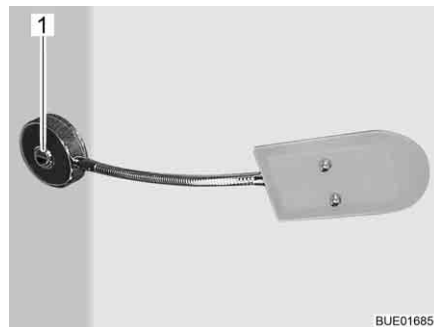

Fig. 43 Interior light, switch mounted directly on the lamp

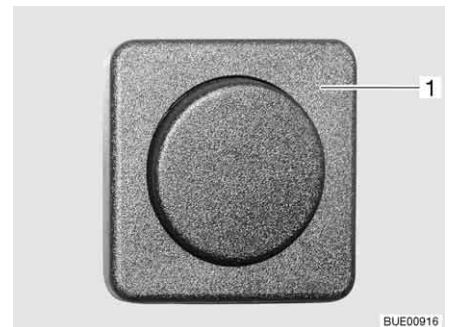

Fig. 44 Interior light, light switch separate from the lamp

The light switches in the living area are located directly on the corresponding lamp (Fig. 43,1) or next to the lamp (Fig. 44,1).

6.4.3 Recessed light with LED

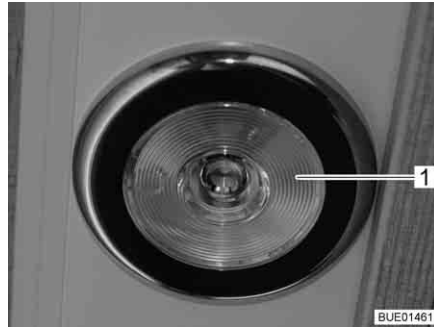

Fig. 45 Recessed light, light switch in the lamp

The light switch is located in the recessed light. To switch on and off, press the interior of the recessed light (Fig. 45,1).

6.5 Spotlight



- ▶ Bulbs and light fittings can be extremely hot.
- ▶ Allow the light bulbs and lamp holders to cool down before touching them.
- ▶ If the light is switched on or still hot, there must always be a safety distance of at least 30 cm between stores or curtains and flammable objects. Fire hazard!



Fig. 46 Spotlight



Fig. 47 Spotlight with flexible arm

Rotating: ■ Grasp the housing (Fig. 46,1 or Fig. 47,1) and swivel it.

The housing can be pivoted in various directions:

- To the left and to the right
- Up and down

6.6 Holder for flat screen



- ▶ Before commencing the journey, place and secure the flat screen and screen support in the initial position. If the screen holder is installed in a TV cabinet: Close TV cabinet.



- ▶ Also read the manufacturer's instruction manual.

6.6.1 Holder on the column

The holder for the flat screen is attached to a column.

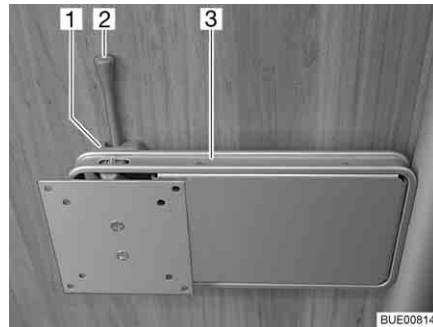

Fig. 48 Holder on the column

Positioning:

- Push the release lever (Fig. 48,2) to the side and turn the holder (Fig. 48,3) with the flat screen to the desired position.
- Press flat screen slightly upward and swivel it to the desired position. Three different inclination angles may be used.

Storing away:

- Turn flat screen back until the holder (Fig. 48,3) engages in the lock (Fig. 48,1).

6.6.2 Rail-mounted holder

The holder for the flat screen is fixed to a rail.

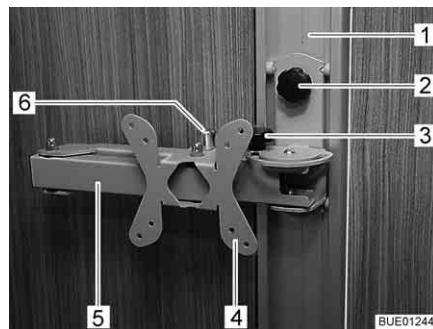

Fig. 49 Rail-mounted holder

Positioning:

- Undo the tommy screw (Fig. 49,2) and adjust the holder (Fig. 49,4) in the rail (Fig. 49,1) until it is at the desired height.
- Re-tighten the tommy screw.
- Undo the tommy screw (Fig. 49,3).
- Pull the release knob (Fig. 49,6). The jointed arm (Fig. 49,5) is unlocked.
- Swivel flat screen into desired position.
- Re-tighten the tommy screw (Fig. 49,3).

Storing away:

- Undo the tommy screw (Fig. 49,3).
- Swing the flat screen back into its original position until you hear the jointed arm (Fig. 49,5) lock into position.
- Re-tighten the tommy screw (Fig. 49,3).
- Undo the tommy screw (Fig. 49,2), adjust the holder (Fig. 49,4) to the desired height and re-tighten the tommy screw.

6.6.3 Holder in the TV cabinet

The flat screen is attached to a console in the TV cabinet.



Fig. 50 Holder in the TV cabinet

Positioning:

- Push the unlocking bar (Fig. 50,1) in.
- Pull out the extension (Fig. 50,2) as far as possible.
- Swivel flat screen into the desired position.

Storing away:

- Swing back flat screen into its original position.
- Push in the extension (Fig. 50,2) until the unlocking bar (Fig. 50,1) engages.

6.6.4 Holder in the TV compartment

The flat screen is fixed to a lifting mechanism in the TV compartment.

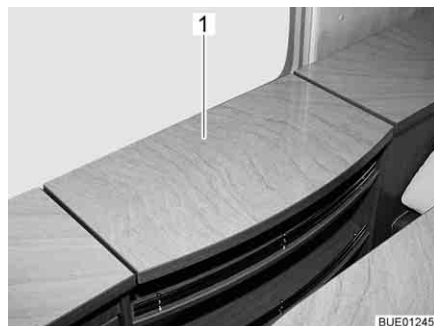

Fig. 51 TV compartment

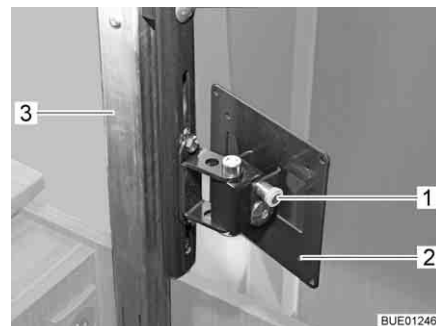

Fig. 52 Lifting mechanism

Positioning:

- Lightly depress the cover (Fig. 51,1) of the TV compartment in the centre. The extension column (Fig. 52,3) is released and starts to move upwards.
- Pull the release knob (Fig. 52,1) and swivel holder (Fig. 52,2) with flat screen to the desired position.

Storing away:

- Turn the flat screen back into the original position until holder (Fig. 52,2) engages in the lock.
- Press the middle of the cover (Fig. 51,1) downwards against the resistance of the extension column (Fig. 52,3) until the locking mechanism engages.

6.7 Heating



- ▶ During heater operation, the exhaust gas pipe in the wardrobe will get hot. Therefore do not keep any heat-sensitive garments right next to the exhaust gas pipe (see also chapter 9).



- ▷ The operation of the heater is described in chapter 9.

6.8 Ventilation



- ▶ The oxygen in the vehicle interior is used up by breathing and the use of gas operated appliances. That is why the used air must be replaced permanently. For this purpose, forced ventilation systems (e.g. skylights with forced ventilation, mushroom-shaped vents or floor vents) are installed in the vehicle. Never cover or block forced ventilations from the inside or outside with objects such as e.g. a winter mat. Keep forced ventilations clear of snow and leaves. There is a danger of suffocation due to increased CO₂ levels.



- ▷ Although sufficient ventilation is provided, in certain weather conditions, condensation can form on metal objects (e.g. screwed connections in the floor).
- ▷ Additional cold spots can occur at thermal "bridges" (e.g. lifting roof edges, mushroom-shaped vents, skylight edges, sockets, filler necks, flaps, etc.).

Condensation

Ensure that there is a continuous exchange of air by providing frequent and efficient ventilation. This is the only method for ensuring that condensation and resulting mould is not formed during cool weather. During the colder season, a pleasant living climate is created if heating output, air distribution and ventilation are synchronised.

If the vehicle is laid up for a longer period, occasionally ventilate it well, especially in summer as heat accumulation can occur. Do not only air the interior, but also the storage spaces which are accessible from the outside. Air the parking place as well if the vehicle is parked in a closed space (e.g. garage). The occurrence of condensation could lead to the formation of mould.

6.9 Windows



- ▷ The windows are fitted with a blind or Roman shade and with an insect screen or folding insect screen. After the latch has been released, the blind and insect screen automatically spring back to the initial position by tensile force. In order not to damage the tension mechanics, hold onto the blind or insect screen and allow it to slowly return to the initial position. The Roman shade and folding insect screen are made of thin woven fabric. In order not to damage the Roman shade or the insect screen, grasp the respective handle and carefully return it to the initial position.
- ▷ Do not keep blinds closed over a longer period of time as that can cause increased material wear.
- ▷ If the blind or the Roman shade is completely closed, exposure to direct sunlight can cause heat to accumulate between the blind/the Roman shade and the window. The window could be damaged.
Therefore, if the shade is installed in the bottom blind box, close the shade only 2/3 when sunlight is intense. This allows the heat to escape between the window and the shade.
If the shade is installed in the top blind box, close the shade fully and open it regularly.
Also move the window into the "continuous ventilation" position.
- ▷ Before commencing the journey, close the windows.
- ▷ Depending on the weather, close the windows far enough to prevent moisture from entering.
- ▷ To open and close the window, open or close all catch levers which are fitted to the window.



- ▷ When leaving the vehicle, always close the windows.
- ▷ In extreme weather conditions or if the temperature fluctuates strongly, a light condensation film can form on the double-glazed acrylic glass. The glass is designed in such a way that condensation can evaporate when the external temperature increases. There is no danger of the double-glazed acrylic glass being damaged by condensation.

6.9.1 Hinged window



- ▷ If windows with automatic hinges are fitted, open the window fully in order to release the lock. If the locking device is not released and the window is closed nevertheless, there is the danger of the window breaking due to the massive counter-pressure.
- ▷ When opening the hinged windows, ensure that there are no torsional forces. Open and close the hinged windows evenly.
- ▷ If the catch lever is equipped with a safety knob, press the safety knob when operating the catch lever.

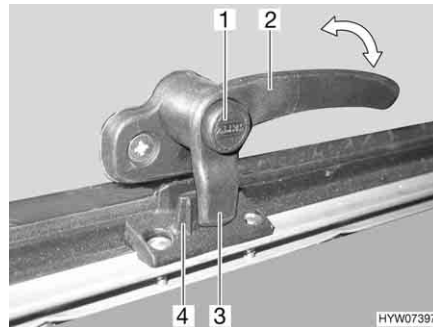

Fig. 53 Catch lever with safety knob in "closed" position

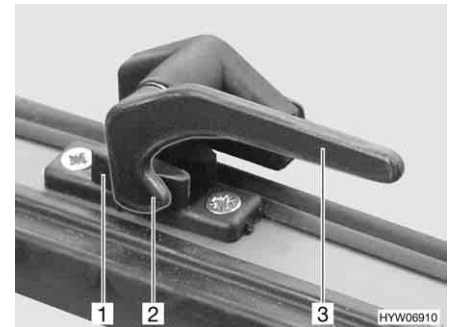

Fig. 54 Catch lever in "closed" position

Opening:

- Press and hold the security button (Fig. 53,1), if present.
- Turn the catch lever (Fig. 53,2 or Fig. 54,3) a quarter turn towards the centre of the window.

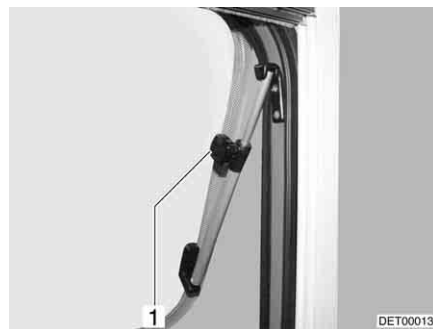

Fig. 55 Hinged window with rotary hinge



Fig. 56 Hinged window with automatic hinge

- Hinged window with rotary hinge: Open the hinged window until the required position has been reached and use knurled knob (Fig. 55,1) to secure in position.
Hinged window with automatic hinge: Open the hinged window to the desired latched position. The automatic hinge (Fig. 56,1) locks in place automatically.

The hinged window remains locked in the required position.

- Closing:*
- Hinged window with rotary hinge: Turn knurled knob (Fig. 55,1) until the latch is released.
Hinged window with automatic hinge: Open the hinged window as wide as is necessary to release the lock.
 - Close the hinged window.
 - Press and hold the security button (Fig. 53,1), if present.
 - Turn the catch lever (Fig. 53,2 or Fig. 54,3) a quarter turn towards the window frame. The locking catch (Fig. 53,3 or Fig. 54,2) on the catch lever is entirely on the inner side of the window catch (Fig. 53,4 or Fig. 54,1).

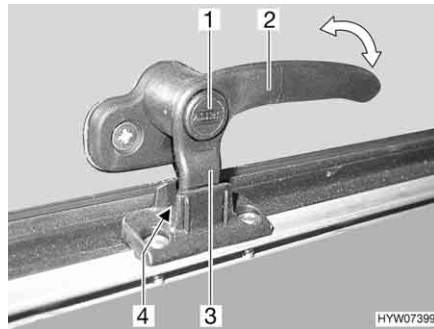

Fig. 57 Catch lever with safety knob in "continuous ventilation" position

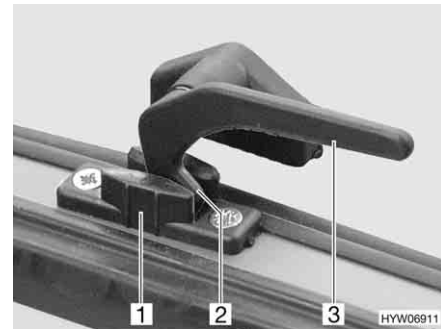

Fig. 58 Catch lever in "continuous ventilation" position

Continuous ventilation

With the catch lever, the hinged window can be placed in two positions:

- "Continuous ventilation" (Fig. 57 and Fig. 58)
- "Firmly closed" (Fig. 53 and Fig. 54)

To place the hinged window into the "continuous ventilation" position:

- Press and hold the security button (Fig. 57,1), if present.
- Turn the catch lever (Fig. 57,2 or Fig. 58,3) a quarter turn towards the centre of the window.
- Slightly open the hinged window outwards.
- Return the catch lever to its initial position. Move the locking catch (Fig. 57,3 or Fig. 58,2) on the catch lever into the recess of the window catch (Fig. 57,4 or Fig. 58,1).
- Press and hold the security button (Fig. 57,1), if present.
- Make certain that the safety knob is not pushed in but rather that it secures the catch lever.

During the journey, the hinged window may not be in "continuous ventilation" position.

If it rains, the "continuous ventilation" hinged window position could lead to splashing water penetrating the living area. Therefore, close the hinged windows completely.

6.9.2 Blind and insect screen



- ▷ Open blinds before commencing the journey. When the blinds are closed, vibrations can damage the spring shaft.



- ▷ Depending on the window size, the blinds are fitted with one or two handles.

The windows are fitted with a blind and an insect screen. The blind and insect screen are adjusted separately.

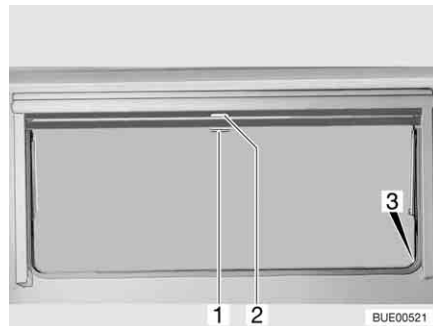

Fig. 59 Hinged window

Blind The blind is located in the upper blind box.

- Closing:*
- Pull blind at the handle (Fig. 59,2) downwards. If the blind is to be completely closed, it is suspended into the locking devices (Fig. 59,3) situated on both sides of the window frame.
- Opening:*
- If the blind is completely closed: Press handle (Fig. 59,2) downwards and, at the same time, tilt it slightly inward. The blind can be taken out of the locking devices situated on both sides of the window frame.
 - If the blind is in an intermediate position: Pull the handle (Fig. 59,2) slightly downwards until the locking device releases.
 - Use handle to return blind slowly to its initial position.

Insect screen The insect screen is located in the upper blind box.

- Closing:*
- Pull insect screen at the handle (Fig. 59,1) down and hang it into the locking devices (Fig. 59,3) situated on both sides of the window frame.
- Opening:*
- Press handle (Fig. 59,1) downwards and, at the same time, tilt it slightly inward. The insect screen can be taken out of the locking devices situated on both sides of the window frame.
 - Use handle to return the insect screen slowly to its initial position.

6.10 Skylights

Depending on the model, skylights with or without forced ventilation are fitted to the vehicle. If a skylight is fitted without forced ventilation, the forced ventilation is performed using mushroom-shaped vents.



- ▶ The apertures for forced ventilation must always be kept open. Never cover or block forced ventilations with objects such as e.g. a winter mat. Keep forced ventilations clear of snow and leaves.



- ▷ The skylights are fitted with a blind or Roman shade and with an insect screen or folding insect screen. After the latch has been released, the blind and insect screen automatically spring back to the initial position by tensile force. In order not to damage the tension mechanics, hold onto the blind or insect screen and allow it to slowly return to the initial position. The Roman shade and folding insect screen are made of thin woven fabric. In order not to damage the Roman shade or the insect screen, grasp the respective handle and carefully return it to the initial position.
- ▷ Do not keep blinds closed over a longer period of time as that can cause increased material wear.
- ▷ If the blind or the Roman shade is completely closed, exposure to direct sunlight can cause heat to accumulate between the blind/the Roman shade and the skylight. The skylight could be damaged. For that reason, close the blind/Roman shade only 2/3 of the way in direct sunlight. Open the skylight slightly or move it to ventilation position.
- ▷ Depending on the weather, close the skylights far enough to prevent moisture from entering.
- ▷ Do not climb on the skylights.
- ▷ Before commencing the journey, close the skylights.
- ▷ Before commencing the journey, check that the skylights are closed and locked.



- ▷ When leaving the vehicle, always close the skylights.

6.10.1 Heki skylight (mini and midi) (partially special equipment)

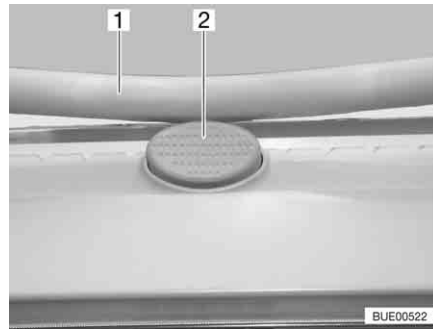

Fig. 60 Safety knob on the Heki skylight

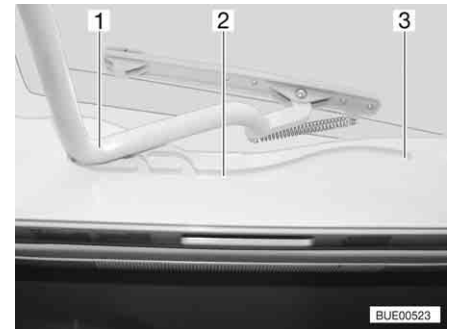

Fig. 61 Heki skylight, guide

The Heki skylight is opened on one side only.

- Opening:*
- Press the safety knob (Fig. 60,2) and pull the bar (Fig. 60,1) down with both hands.
 - Pull the bar (Fig. 61,1) in the guides (Fig. 61,2) to the rearmost position (Fig. 61,3).
- Closing:*
- Use both hands to push the bar (Fig. 61,1) slightly upwards.
 - Push the bar back in the guides.
 - Push the bar upwards with both hands until it is above the safety knob (Fig. 60,2).

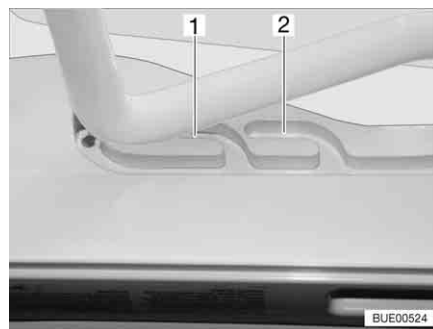

Fig. 62 Heki skylight in ventilation position

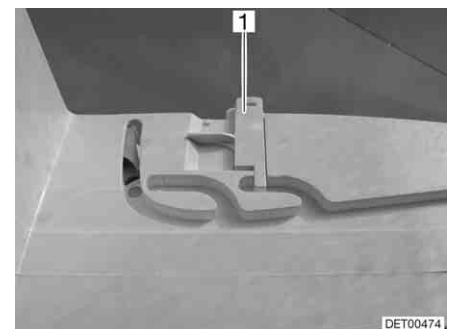

Fig. 63 Ventilation position locking mechanism

Ventilation position

The Heki skylight can be put in two ventilation positions: Bad weather position (Fig. 62,1) and central position (Fig. 62,2). Depending on the model, the skylight can be locked in the central position with both left and right latches (Fig. 63,1) on the skylight frame.

- Press the safety knob (Fig. 60,2) and pull the bar (Fig. 60,1) down with both hands.
- Pull the bar in the guides (Fig. 61,2) to the desired position.
- Push the bar slightly upwards and into the selected guide (Fig. 62,1 or 2) and lock if necessary.

Roman shade To close and open the Roman shade:

Closing: ■ Pull out Roman shade at the handle and release in the required position. The Roman shade will stay in that position.

Opening: ■ Slowly push the Roman shade at the handle to its initial position.

Insect screen To close and open the insect screen:

Closing: ■ Pull the insect screen by the handle to the opposite handle of the Roman shade.

Opening: ■ Press the rear part of the handle of the insect screen. The latch is released.
■ Use handle to return the insect screen slowly to its initial position.

6.10.2 Heki skylight (special equipment)

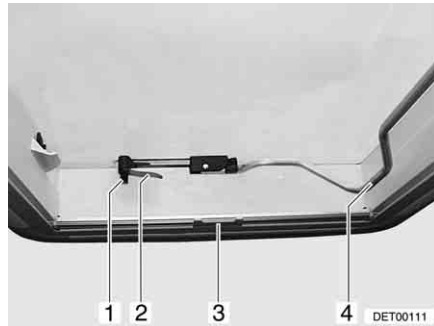

Fig. 64 Heki skylight, closed

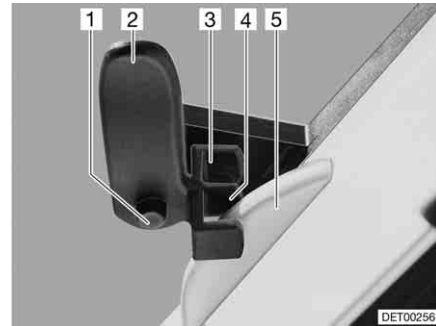

Fig. 65 Heki skylight in ventilation position 1

The Heki skylight may be opened on one side only.

Opening: ■ Press the safety knob (Fig. 64,1) and turn the catch lever (Fig. 64,2) one quarter turn inward.
■ Pull the bar (Fig. 64,4) downwards out of the latch.
■ Press the Heki skylight upwards using the bar.
■ Press the bar back into the latch.

Closing: ■ Pull the bar (Fig. 64,4) downwards out of the latch.
■ Pull the Heki skylight downward using the bar.
■ Turn the catch lever (Fig. 64,2 and Fig. 65,2) one quarter turn. The hook of the roof lock (Fig. 65,5) must engage in the upper locking fork (Fig. 65,3).
■ Press the bar back into the latch.

Ventilation position (variant 1): ■ Open Heki skylight and push lightly outwards.
■ Press the safety knob (Fig. 65,1) and turn the catch lever (Fig. 65,2) back. The hook of the roof lock (Fig. 65,5) must engage in the lower locking fork (Fig. 65,4).
■ Press the bar back into the latch.

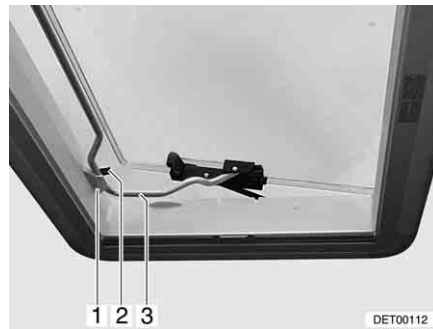

Fig. 66 Heki skylight in ventilation position 2

Ventilation position (variant 2):

- Open Heki skylight.
- Insert the bar (Fig. 66,3) into the holder (Fig. 66,1).
- Place the lever (Fig. 66,2) over the bar.

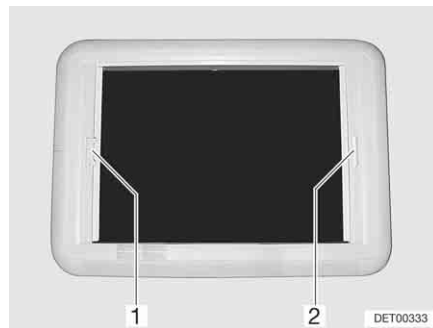

Fig. 67 Heki skylight, blind lock

Blind To close and open the blind:

- Closing:*
- Pull blind at the handle (Fig. 67,2) to the opposite handle of the insect screen (Fig. 67,1) and allow to engage.
- Opening:*
- Hold the blind screen by the handle with one hand.
 - With your other hand, push the unlocking bar on the handle of the insect screen (Fig. 67,1) towards the handle. The lock is released.
 - Use handle to return the blind slowly to its initial position.

Insect screen To close and open the insect screen:

- Closing:*
- Pull insect screen at the handle (Fig. 67,1) to the opposite handle of the blind (Fig. 67,2) and allow to engage.
- Opening:*
- Hold the insect screen (Fig. 67,1) by the handle and push the unlocking bar towards the handle. The lock is released.
 - Use handle to return the insect screen slowly to its initial position.

6.11 Tables

6.11.1 Suspension table with folding leg

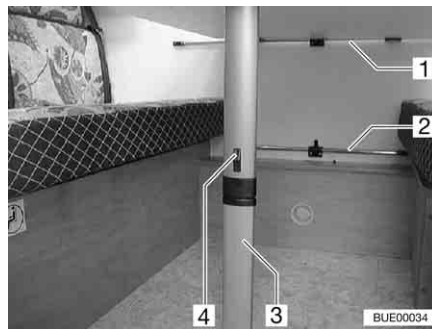

Fig. 68 Suspension table with folding leg

The suspension table may also be used as a bed foundation.

Conversion to bed foundation:

- Slightly lift the front of the table-top.
- Move the locking device (Fig. 68,4) toward the table-top.
- Fold the lower section of the foot (Fig. 68,3) under by 90°.
- Detach the suspension table from the upper attachment rail (Fig. 68,1).
- Attach the suspension table to the lower attachment rail (Fig. 68,2) and rest it onto the table leg hinge.

6.11.2 Swivel table



- ▷ Reduce the size of the swivel table before commencing the journey.



Fig. 69 Swivel table with metal frame

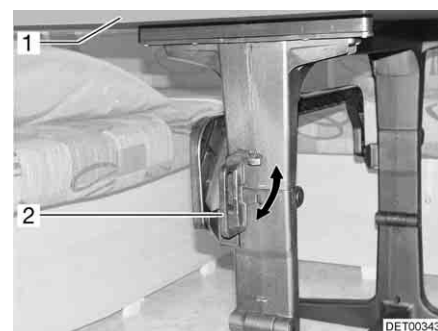

Fig. 70 Swivel table with plastic frame

The swivel table's swivel mechanism enables it to be used as a bed foundation.

Conversion to bed foundation:

- Push the handle (Fig. 69,2) upwards or turn the handle (Fig. 70,2) to the horizontal position.
- Swivel the table-top (Fig. 69,1 or Fig. 70,1) downward in a circular movement.
- Allow the (Fig. 69,2) handle to click into place or turn the handle (Fig. 70,2) back into the vertical position. The swivel mechanism is locked.

6.11.3 Suspension table and swivel table

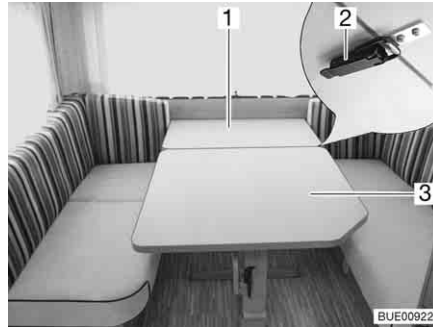

Fig. 71 Suspension table and swivel table



Fig. 72 After conversion to round seating group

The combination consisting of suspension table and swivel table can be converted into a round seating group.

Conversion to round seating group:

- Open two locks (Fig. 71,2) on the underside of the table top.
- Pull swivel table (Fig. 71,3) slightly toward the centre.
- Lift the table top of the suspension table (Fig. 71,1) approx. 45°.
- Pull lower section of the suspension table foot downwards and fold over by 90°.
- Remove the suspension table from its upper retainer.
- Hook suspension table into the lower retainer and use the foot to place on the ground.
- Place the additional cushions.
- Push swivel table to the rear again (Fig. 72).

6.11.4 Lift-off table

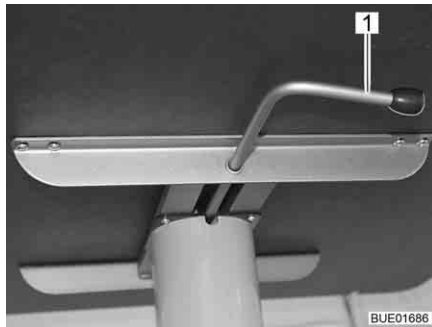

Fig. 73 Lift-off table

The table's lifting mechanism enables it to be also used as a bed foundation.

Conversion to bed foundation:

- Swivel the catch lever (Fig. 73,1) to the left. The lock of the lifting mechanism is open.
- Press the table-top in the middle down to the stop limit and hold it down.
- Swivel the catch lever (Fig. 73,1) to the right (Fig. 73). The lifting mechanism is locked.

Conversion to table:

- Swivel the catch lever (Fig. 73,1) to the left. The lock of the lifting mechanism is open. The table-top moves upwards to the limit stop.
- Swivel the catch lever to the right (Fig. 73). The lifting mechanism is locked.

6.11.5 Suspension table and lift-off table

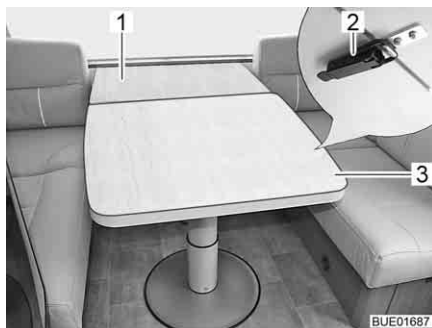

Fig. 74 Suspension table and lift-off table



Fig. 75 After conversion to round seating group

The combination consisting of suspension table and lift-off table can be converted into a round seating group.

Conversion to round seating group:

- Open two locks (Fig. 74,2) on the underside of the table top.
- Pull lift-off table (Fig. 74,3) slightly toward the centre.
- Lift the table top of the suspension table (Fig. 74,1) approx. 45°.
- Pull lower section of the suspension table foot downwards and fold over by 90°.

- Remove the suspension table from its upper retainer.
- Hook suspension table into the lower retainer and use the foot to place on the ground.
- Place the additional cushions.
- Push lift-off table to the rear again (Fig. 75).

6.12 Beds

6.12.1 Bunk bed



- ▶ Only use the upper bunk bed if the safety guard is fitted.
- ▶ The maximum permitted bunk bed load is 100 kg.
- ▶ The upper bunk bed must not be used by children under 6 years of age.
- ▶ Never allow small children to remain in the bunk bed without supervision.
- ▶ But in particular with regard to small children less than 6 years of age, users should ensure that they cannot fall out of the bunk bed.
- ▶ Use separate children's beds or travel cots suitable for children.

Depending on the model, the vehicle is fitted with a bunk bed. The bunk bed can be used immediately, without additional conversion.

Always use the access ladder provided to climb up to the top bed.

6.12.2 Fixed bed (spring release lever)



- ▶ Carefully press the slatted frame downwards when closing the bed. The springs bring the slatted frame down quickly at the end of the movement. There is a risk of crushing!

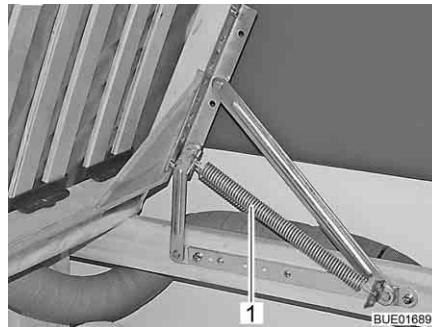

Fig. 76 Fixed bed

A storage compartment is underneath the bed. Lift up the slatted frame to place items in the storage compartment or to empty it from the inside of the vehicle.

- Opening:*
- Pull the mattress slightly toward the centre.
 - Lift slatted frame. The springs (Fig. 76,1) hold the slatted frame open.
- Closing:*
- Press the slatted frame downwards against the resistance of the springs.

6.12.3 Pull-down bed, manually operated (Premio Plus and Averso Plus)



- ▶ Switch off the reading lamps in the pull-down bed before the bed is pushed up. Fire hazard!
- ▶ Switch off the reading lamps on the underside of the pull-down bed when the bed is lowered. Fire hazard!
- ▶ The maximum permitted pull-down bed load is 200 kg.
- ▶ Before commencing the journey, secure the pull-down bed. To do this, lock the pull-down bed.
- ▶ Before use, pull the pull-down bed into the lower end position. Ensure that the pull-down bed is not resting on obstacles such as headrests, cushions or similar.
- ▶ Only use the pull-down bed, if the safety net is set up.
- ▶ Never allow small children to remain in the pull-down bed without supervision.
- ▶ But in particular with regard to small children less than 6 years of age, users should ensure that they cannot fall out of the pull-down bed.
- ▶ Use separate children's beds or travel cots suitable for children.



- ▷ You must be able to close the pull-down bed without any great effort, so that there is no tension in the locking position. Objects on the pull-down bed can distort the lifting mechanism on one side, resulting in damage.

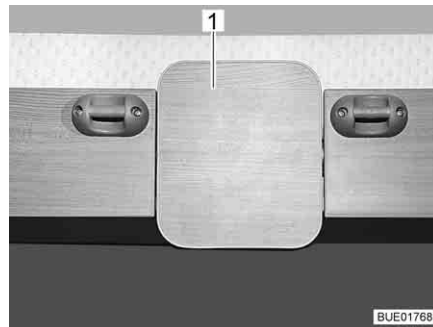

Fig. 77 Release (Premio Plus)

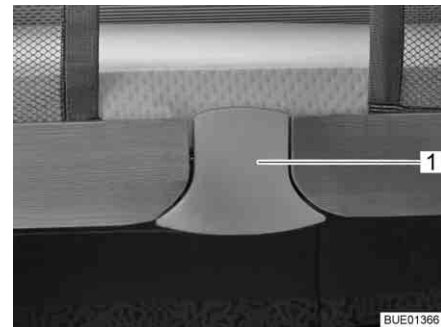

Fig. 78 Release (Averso Plus)

The pull-down bed is located above the rear seating group.

The pull-down bed has two locking positions in the uppermost position. The pull-down bed is securely locked in both locking positions.

Lowering the pull-down bed:

- Switch off the lamps underneath the pull-down bed.
- Remove any obstacles in the area into which the pull-down bed extends (e.g. headrests).
- Fold over the back cushions.
- Pull out the release area (Fig. 77,1 or Fig. 78,1) at the bottom. The lock is released.
- Use both hands to pull the pull-down bed down as far as it will go.

- If the pull-down bed was in the uppermost locking position: Pull the release area out again to override the second locking position. Use both hands to pull the pull-down bed down as far as it will go.
- Make sure that the pull-down bed is in the lower end position and is not resting on obstacles such as headrests or cushions.



Fig. 79 Folding aid

Lifting the pull-down bed:

- Switch off the reading lamps on the ceiling.
- Use both hands to push the pull-down bed upwards as far as the first locking position. When doing this, make sure that the folding aids (Fig. 79,1) pull in the side fabric panels on both sides. If necessary, push the pull-down bed further upwards as far as the uppermost locking position. When doing this, ensure that the snap latch engages audibly in the locking bracket.
- Check that the pull-down bed is locked correctly. To do this, pull down the pull-down bed firmly.



- ▷ Depending on the model, the pull-down bed is equipped with a one-piece or two-piece safety net.



Fig. 80 Pull-down bed complete with applied safety net

Safety net

The safety net (Fig. 80,2) and the retaining belts are located underneath the mattress in the pull-down bed. Only use the safety net if persons are already in the pull-down bed.

Setting up:

- Attach the retaining belts (Fig. 80,1) to the hooks on the ceiling.

Access ladder Always use the provided access ladder (Fig. 80,5) to climb up to the pull-down bed.

Attaching: ■ Hook access ladder (Fig. 80,5) to the pull-down bed by attaching the two hooks (Fig. 80,4) in the holding bar (Fig. 80,3).

Storing away: ■ Hang the access ladder (Fig. 80,5) from the holding bar (Fig. 80,3) on the pull-down bed.
■ Store the access ladder securely.

6.12.4 Folding bed in cabinet



- ▶ Only use the folding bed in cabinet if the safety nets are set up.
- ▶ The maximum permitted load for the folding bed in cabinet is 60 kg.
- ▶ Before commencing the journey, secure the folding bed in cabinet.
- ▶ Never allow small children to remain in the folding bed in cabinet without supervision.
- ▶ In particular with regard to small children less than six years of age, users should ensure that they cannot fall out of the folding bed in cabinet.
- ▶ Use separate children's beds or travel cots suitable for children.

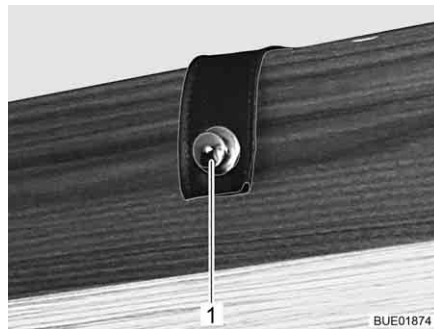

Fig. 81 Belt with pull knob



Fig. 82 Release

Opening the folding bed in cabinet:

- Open the pull knob (Fig. 81,1) on the belt.
- Push the push button (Fig. 82,1). The push button jumps out.
- Hold the push button and swing down the folding bed in cabinet until it is resting on the side supports (Fig. 82,2).



Fig. 83 Safety nets and table element

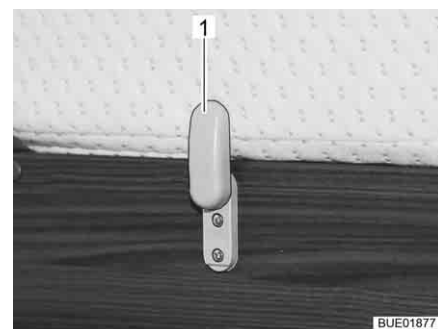

Fig. 84 Locking bars

- Take the safety nets (Fig. 83,3) off the lying surface.
- Place the table element (Fig. 83,1) onto the lying surface (Fig. 83,2).

- Press down the locking bars (Fig. 84,1) of the mattress.
- Place the mattress onto the lying surface and unfold it.

Closing the folding bed in cabinet:

- Fold the mattress together and secure it with the locking bars. To do this, press up the locking bars.
- Place the table element in front of the mattress.
- Lay the safety nets onto the sleeping area.
- Swivel up the folding bed in cabinet.
- Close the belt with pull knob.
- Check that the folding bed in cabinet is locked correctly.

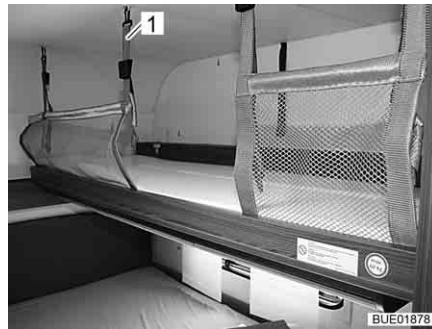

Fig. 85 Folding bed in cabinet with fitted safety net

Safety net Do not set up the two safety nets until the person is already in the folding bed in cabinet.

Setting up: ■ Attach the retaining belts (Fig. 85,1) to the hooks on the ceiling.

6.12.5 Widening single beds (special equipment)

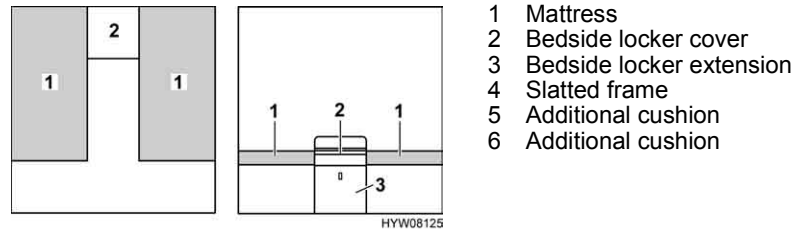

Fig. 86 Prior to conversion

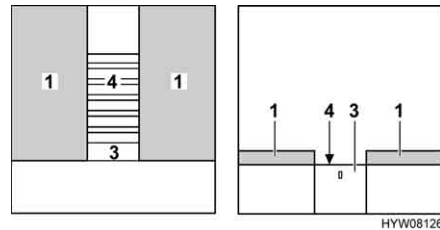

Fig. 87 During conversion

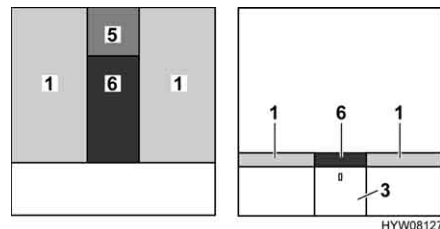

Fig. 88 After conversion

- Remove the bedside locker cover (Fig. 86,2) and put it to one side.
- Pull out slatted frame (Fig. 87,4) completely. To do this, pull on the extension (Fig. 87,3).
- Place the additional cushion (Fig. 88,5) on the bedside locker.
- Place the additional cushion (Fig. 88,6) between the mattresses (Fig. 88,1).

6.13 Converting seating groups for sleeping

The following table gives an overview of the seating groups installed in the different models and names the section in which the bed conversion is described.

Model	Seating group	Observation	Section	
Premio Plus	510 TK	Round/rear seating group	Without additional cushion	6.13.6
	510 TK	Bench/front seating group	With additional cushion	6.13.2

Averso Top

Model	Seating group	Observation	Section
430 TS	Bench/rear seating group	With additional cushion	6.13.2
450 TS	Bench/rear seating group	With bed widening and additional cushion	6.13.8
460 TS	Round/rear seating group	Without additional cushion	6.13.6
465 TS	Round/front seating group	Without additional cushion	6.13.6
470 TS	Bench/central seating group	With bed widening and additional cushion	6.13.4
475 TL	Round/rear seating group	Without additional cushion	6.13.6
485 TS	Round/rear seating group	Without additional cushion	6.13.6
520 TK	Bench/central seating group	Without additional cushion	6.13.1
535 TL	Round/rear seating group	Without additional cushion	6.13.6
545 TS	Bench/central seating group	With bed widening and additional cushion	6.13.4
560 TK	Bench/central seating group	With additional cushion	6.13.5

Nordic

580 TS	Round/front seating group	With additional cushion	6.13.7
600 TK	Round/front seating group	With additional cushion	6.13.7
650 TS	Round/front seating group	With additional cushion	6.13.7
	Bench/central seating group	With additional cushion	6.13.3

Averso Plus

410 TS	L-seating/rear seating group	Not convertible into bed	–
440 TK	Round/rear seating group	Without additional cushion	6.13.6
510 TK	Round/rear seating group	Without additional cushion	6.13.6
510 TK	Bench/front seating group	With additional cushion	6.13.2



- ▷ The following representations are partly valid for different vehicles. Therefore, the length, width and form of individual cushions may differ from the ones shown here.

6.13.1 Bench seating group without additional cushions

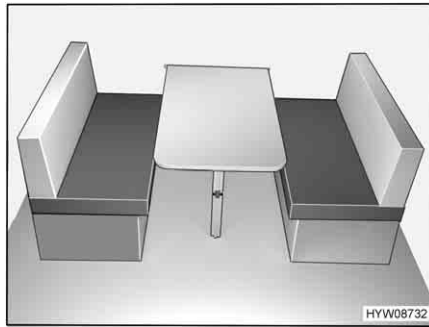

Fig. 89 Prior to conversion

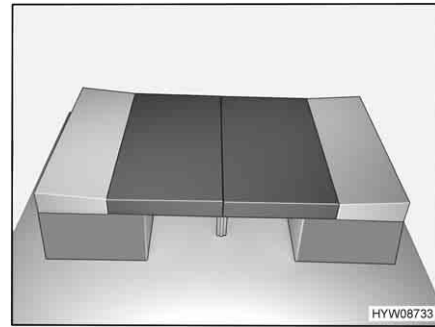

Fig. 90 After conversion

- Convert the table to a bed foundation (see section 6.11).
- Pull the seat cushions into the centre.
- Insert the back cushions between the seat cushions and the wall (see Fig. 90).

6.13.2 Bench seating group with additional cushions

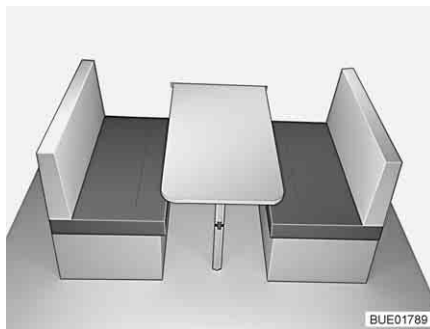

Fig. 91 Prior to conversion

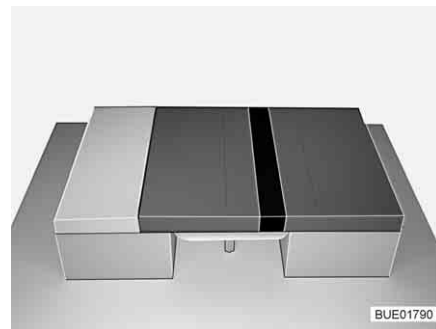

Fig. 92 After conversion

- Convert the table to a bed foundation (see section 6.11).
- Remove a back cushion and lay it aside.
- Pull one seat cushion into the centre.
- Insert the remaining back cushion between the seat cushion and the wall.
- Insert the additional cushion between the seat cushions (see Fig. 92).

6.13.3 Bench seating group with additional cushions (angled)

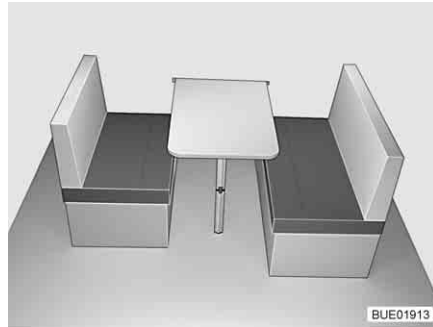

Fig. 93 Prior to conversion

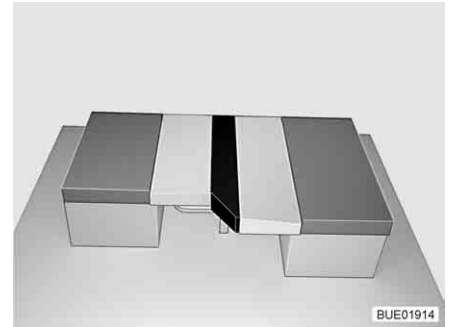

Fig. 94 After conversion

- Convert the table to a bed foundation (see section 6.11).
- Remove the short back cushion and lay it aside.
- Place the long back cushion onto the table in front of the seat cushion.
- Insert the additional cushion between the back cushion and the seat cushion as shown (see Fig. 94).

6.13.4 Bench seating group with bed widening



Fig. 95 Prior to conversion



Fig. 96 After conversion

- Convert the table to a bed foundation (see section 6.11).
- Widen the benches.
- Remove a back cushion and lay it aside.
- Pull one seat cushion into the centre.
- Insert the remaining back cushion between the seat cushion and the wall.
- Place the slim additional cushion between the seat cushions.
- Place the two wider additional cushions on the bench seat enlargements (see Fig. 96).

6.13.5 Round seating group with additional cushion (foldable)

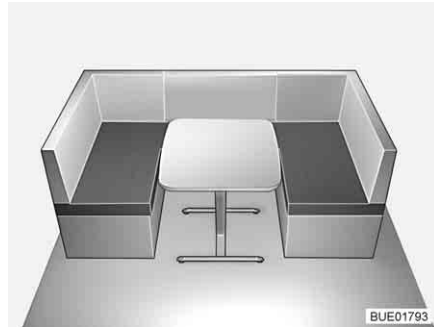

Fig. 97 Prior to conversion



Fig. 98 After conversion

- Convert the table to a bed foundation (see section 6.11).
- Remove all back cushions and lay them aside.
- Unfold the additional cushion and lay it between the seat cushions (see Fig. 98).

6.13.6 Round seating group without additional cushion

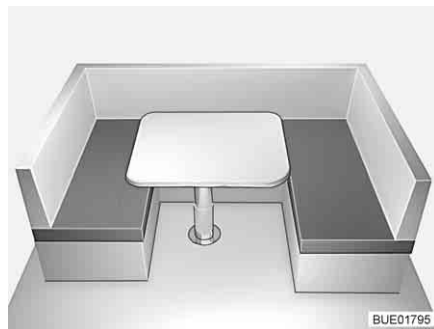

Fig. 99 Prior to conversion

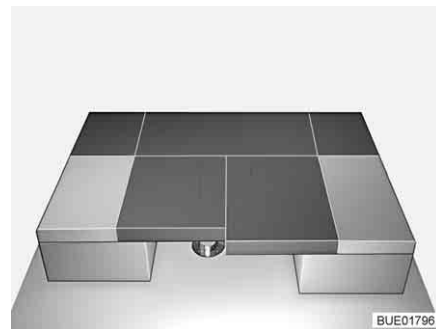

Fig. 100 After conversion

- Remove the back corner cushions and the rear back cushion and store them under the table.
- Place the side seat cushions in an upright position.
- Convert the table to a bed foundation (see section 6.11).
- Place the side back cushions against the exterior wall.
- Press the two seat cushions between the back cushions (see Fig. 100).

6.13.7 Round seating group with additional cushion

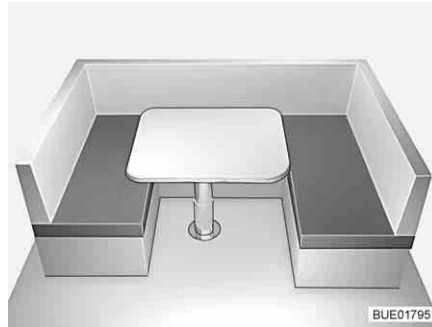

Fig. 101 Prior to conversion

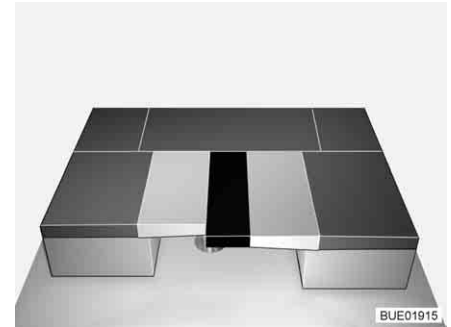

Fig. 102 After conversion

- Remove the back corner cushions and the rear back cushion and store them under the table.
- Convert the table to a bed foundation (see section 6.11).
- Place the side back cushion onto the table in front of the seat cushion. The flat side faces up.
- Insert the additional cushion between the back cushions (see Fig. 102).

6.13.8 Round seating group with bed widening

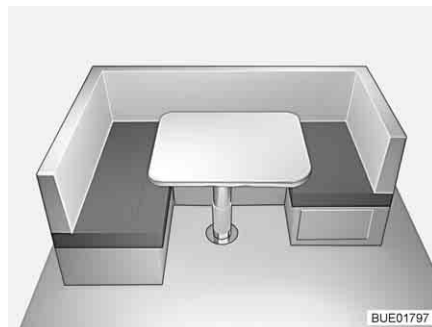

Fig. 103 Prior to conversion

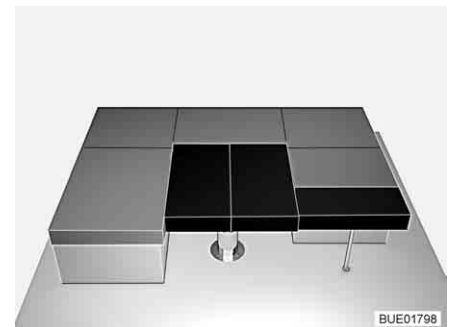

Fig. 104 After conversion

- Convert the table to a bed foundation (see section 6.11).
- Unlatch and fold up the bedding box extension.
- Place support into the holder on the bedding box extension.
- Remove all back cushions and lay them aside.
- Unfold the additional cushion and lay it between the seat cushions.
- Place the small additional cushion on the bedding box extension (see Fig. 104).

6.14 Shower connection point for external shower (special equipment)



- ▶ Only use the external shower if there is a gap of at least 1.20 m between the shower and the nearest electrical device or connection. Risk of electric shock!



- ▷ If decommissioned for a longer time or if there is a risk of frost, drain the water system.

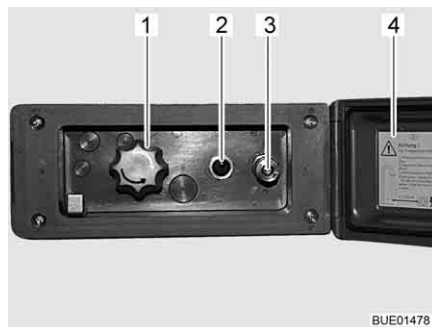

Fig. 105 External shower connection point

Connecting an external shower:

- Unlock and open the cover (Fig. 105,4).
- Attach hose of the external shower to the quick closure (Fig. 105,3).

Using the shower:

- Switch on the water pump using the switch (Fig. 105,2).
- Adjust the water temperature with the rotary knob (Fig. 105,1) as desired.
- Switch off the water pump using the switch (Fig. 105,2).

Shutting off the shower connection point:

- Switch off the water pump using the switch (Fig. 105,2).
- Disconnect the hose from the quick closure. The quick closure is equipped with a check valve to prevent any further water from escaping.
- Close the cover (Fig. 105,4) and lock with key.

Emptying:

- Attach hose of external shower to quick closure. The check valve is opened and the connections can run dry.
- Turn knob (Fig. 105,1) to the centre position.
- Empty the water system (see section 10.2.4).

Chapter overview

This chapter contains instructions regarding the gas system of the vehicle. The instructions address the following topics:

- safety
- changing the gas bottles
- gas isolator taps
- external gas connection
- automatic switching facility

The operation of the gas operation appliances of the vehicle is described in chapter 9.

7.1 General



- ▶ Before commencing the journey, when leaving the vehicle or when gas equipment is not in use, close all gas isolator taps and the main isolator tap on the gas bottle.
- ▶ All gas-operated devices (heater, cooker, oven, grill, refrigerator - depending on the equipment) must be switched off for refuelling, on ferries or in the garage. Danger of explosion!
- ▶ Do not use gas-operated devices in closed spaces (e.g. garages). Danger of poisoning and suffocation!
- ▶ Only have the gas system maintained, repaired or altered by an authorised specialist workshop.
- ▶ Have the gas system checked by an authorised specialist workshop according to the national regulations before commissioning. This also applies for not registered vehicles. For modifications to the gas system have the gas system immediately checked by an authorised specialist workshop.
- ▶ The gas pressure regulator and exhaust gas pipes must also be inspected. The gas pressure regulator has to be replaced after 10 years at the latest. The vehicle owner is responsible for seeing that this is carried out.
- ▶ In case of a defect of the gas system (gas odour, high gas consumption) there is danger of explosion! Close regulator tap on the gas bottle immediately. Open doors and windows and ventilate well.
- ▶ If the gas system is defective: Do not smoke; do not ignite any open flames, and do not operate electric switches (light switches etc.). Do not check tightness of gas-conducting parts and pipes with an open flame.
- ▶ Only the stipulated devices may be connected to internal connections. Do not operate any device outside the vehicle if it is connected to an internal connector.
- ▶ Before using the cooker make sure that there is sufficient ventilation. Open a window or the skylight.
- ▶ Do not use the gas cooker or gas oven for heating purposes.
- ▶ If there are several gas devices, each gas device must have its own gas isolator tap. If individual gas devices are not in use, close the respective gas isolator tap.



- ▶ Ignition safety valves must close within 1 minute after the gas flame has extinguished. A clicking sound is audible. Check function from time to time.
- ▶ The built-in gas devices are exclusively meant for use with propane or butane gas or a mixture of both. The gas pressure regulator as well as all built-in gas devices are designed for a gas pressure of 30 mbar.
- ▶ Propane gas is capable of gasification up to -42 °C, whereas butane gas gasifies at 0 °C. Below these temperatures no gas pressure is available. Butane gas is unsuitable for use in winter.
- ▶ Regularly inspect the gas tube fitted to the gas bottle connection for tightness. The gas tube must not have any tears and must not be porous. Have the gas tube replaced by an authorised specialist workshop no later than ten years after the manufacturing date. The operator of the gas system must see to it that the parts are replaced.
- ▶ Due to its function and construction, the gas bottle compartment is a space which is open to the exterior. Never cover or block up the standard forced ventilations. Otherwise gas that is emitted can not be diverted to the outside.
- ▶ Secure the gas bottle compartment against unauthorised access. To do this, lock the compartment.
- ▶ The regulator tap on the gas bottle must be accessible.
- ▶ Only connect gas-operated devices (e.g. gas grill) which have been designed for a gas pressure of 30 mbar.
- ▶ The exhaust gas pipe must be fitted tightly to the heating system and to the vent and must be sealed. The exhaust gas pipe must not show any evidence of damage.
- ▶ Exhaust fumes must be able to escape into the atmosphere unhindered and fresh air must be able to enter unhindered. For this reason, keep the exhaust pipe and intake openings clean and unobstructed (e.g. free from snow and ice). For this reason, no snow walls or aprons may lie against the vehicle.

7.2 Gas bottles



- ▶ Gas bottles are only to be transported within the designated gas bottle compartment.
- ▶ Place the gas bottles in vertical position in the gas bottle compartment.
- ▶ Fasten the gas bottles so that they are unable to turn or tilt.
- ▶ Connect the gas tube to the gas bottle without tension.
- ▶ If the gas bottles are not connected to the gas tube, always place the protective cap on top.
- ▶ Close the regulator tap on the gas bottle before the gas pressure regulator or gas tube are removed from the gas bottle.
- ▶ Use your hands only to connect the gas pressure regulator or the gas tube to the gas bottles. Do not use any tools.
- ▶ Only use special gas pressure regulators with a safety valve designed for vehicle use. Other gas pressure regulators are not permitted and cannot meet the demanding requirements.
- ▶ Use the gas pressure regulator defroster if the temperature falls below 5 °C.



- ▶ Use only 11 kg or 5 kg gas bottles. Camping gas bottles with built-in check valve (blue bottle with max. 2.5 or 3 kg content) are can be used in exceptional cases with a safety valve.
- ▶ Use the shortest possible tube lengths (150 cm max.) for external gas bottles.
- ▶ Never block the floor ventilation openings below the gas bottles.



- ▷ For gas-operated units the gas pressure must be reduced to 30 mbar.
- ▷ Connect gas pressure regulator complete with safety valve directly to bottle valve.
The gas pressure regulator reduces the gas pressure in the gas bottle down to the operating pressure of the gas devices.
- ▷ For filling and connecting the gas bottles in Europe the accessories shops have corresponding Euro filling sets and Euro bottle sets.
- ▷ Information available at the dealers or service centre.
- ▷ For information on the gas supply in Europe see chapter 17.

7.3 Changing gas bottles



- ▶ When changing gas bottles, do not smoke or create any open fire.
- ▶ When you have changed the gas bottle, check whether gas escapes at the connection points and unions. Use a leakage search spray to spray the relevant connection point or union. These agents are available at the accessories shop.

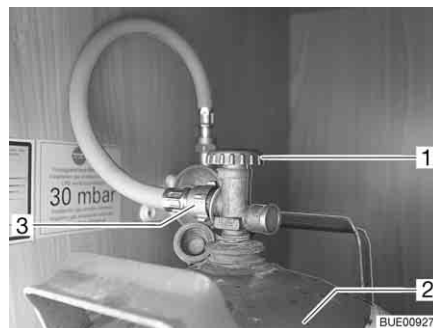
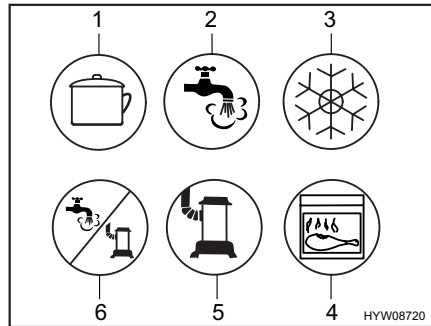

Fig. 106 Gas bottle compartment

- Open the external flap for the gas bottle compartment (see chapter 6).
- Close the regulator tap (Fig. 106,1) on the gas bottle (Fig. 106,2). Pay attention to the direction of the arrow.
- Unscrew the gas tube (Fig. 106,3) by hand from the gas bottle.
- Release the fixing belts and remove the gas bottle.
- Place a filled gas bottle in the gas bottle compartment.
- Fix gas bottle in place with the fixing belts.
- Screw gas tube on gas bottle by hand.
- Close the external flap for the gas bottle compartment.

7.4 Gas isolator taps



- 1 Cooker
- 2 Hot water
- 3 Refrigerator
- 4 Oven/grill
- 5 Heater
- 6 Hot water/heating

Fig. 107 Possible symbols for the gas isolator taps

A gas isolator tap (Fig. 107) for every gas device is built into the caravan. The gas isolator taps can be found under the cooker.

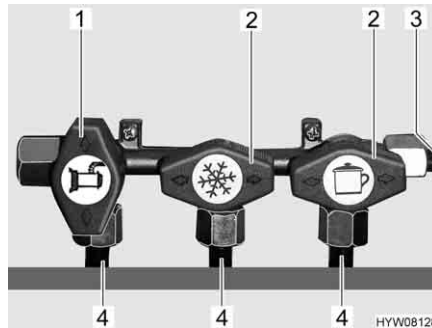

- 1 Gas isolator tap open
- 2 Gas isolator tap closed
- 3 Gas pipe
- 4 Pipe to the gas appliance

Fig. 108 Gas shut-off valves position (example)

- Opening:*
- Position the gas isolator tap of the corresponding appliance parallel (Fig. 108,1) to the pipe (Fig. 108,4) leading to the gas appliance.
- Closing:*
- Position the gas isolator tap of the corresponding appliance transverse (Fig. 108,2) to the pipe (Fig. 108,4) leading to the gas appliance.

7.5 External gas connection (special equipment)



- ▶ If the external gas connection is not in use, always close the gas isolator tap.
- ▶ Only gas appliances with a suitable adapter should be connected to the external gas connection.
- ▶ Connect only external gas appliances which are designed for an operation pressure of 30 mbar.
- ▶ Once you have made the connection and opened the gas isolator tap, make sure that no gas is escaping at the connection point. If there is a leak in the external gas connection, gas will escape into the open air. Immediately close the gas isolator tap and the regulator tap on the gas bottle. Have the external gas connection checked by an authorised specialist workshop.



- ▶ When connecting an external gas appliance, make sure that there is nothing near the external gas connection that could cause a spark.
- ▶ Do not use the external gas connection to fill gas bottles. Observe the information stickers on the external gas connection.

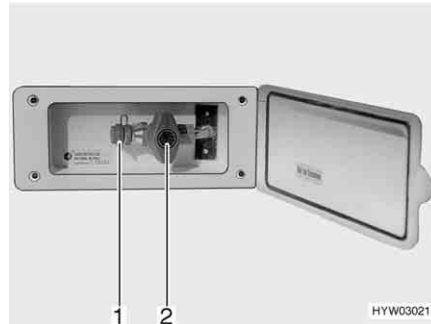

Fig. 109 External gas connection, gas isolator tap closed

The external gas connection (Fig. 109) is located at the rear or to the left or right of the vehicle depending on the model.

- Connect the external gas device to the connection point (Fig. 109,1).
- Open the gas isolator tap (Fig. 109,2).

7.6 Crash protection unit switching facility (special equipment)



- ▶ Do not use the switching facility in closed spaces.



- ▷ When the vehicle is equipped with the crash protection unit the living area heater may be operated during the journey.
- ▷ If the vehicle is equipped with a panel of the DT series and the switching facility is operated via this panel, the operating unit is redundant.
- ▷ Also read the manufacturer's instruction manual.

The crash protection unit is an automatic switching facility with a control unit for a two-bottle gas system. The switching facility automatically switches gas supply from the primary bottle to the reserve bottle as soon as the primary bottle is either empty or no longer ready for operation. The gas appliances may still continue operation. The switching facility is suitable for all commercial gas bottles from 3 kg to 33 kg. In the event of an accident or a too high angle of the vehicle the gas supply will automatically be interrupted.

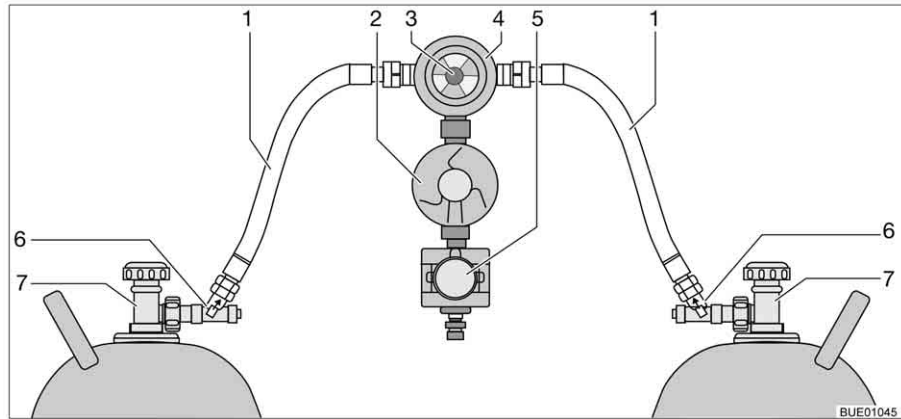

Fig. 110 Crash protection unit switching facility

Construction of the unit

The crash protection unit consists of two flow restrictors with manual release button (Fig. 110,6) a reversing valve (Fig. 110,4) with pressure regulator (Fig. 110,2), an electrovalve (Fig. 110,5) and the operating unit with tricoloured LED. The reversing valve is installed between the two gas tubes (Fig. 110,1).

Use the knob (Fig. 110,3) on the reversing valve to select which of the gas bottles is to be used as a primary bottle and which is to be used as a reserve bottle.



Fig. 111 Operating unit

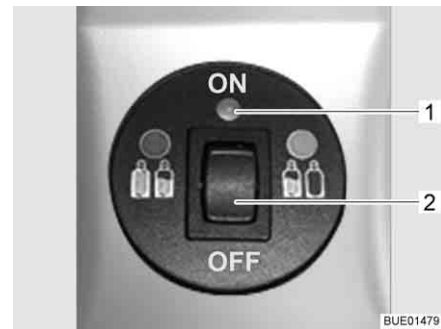

Fig. 112 Operating unit with remote display

Only the electrical functions can be switched at the operating unit (Fig. 111). The regulator taps on the gas bottles (Fig. 110,7) and the release buttons (Fig. 110,6) must be opened manually.

The reversing valve provides a constant gas pressure, regardless of which gas bottle is being drawn upon. The display in the reversing valve shows the filling level of the primary bottle. The gas supply comes from the primary bottle when the display is green. When the display is red the primary bottle is empty. In this case, the reserve bottle is used for the gas supply.

Without remote display

The indicator lamp on the operating unit shows the condition of the gas system. The system is okay when the indicator lamp (Fig. 111,1) lights up green. When the indicator lamp lights up or flashes red a fault has occurred. The gas supply is interrupted.

With remote display

The indicator lamp on the operating unit (Fig. 112,1) shows the condition of the gas system:

Indicator lamp	Signification
Off	System switched off, gas supply switched off
Green	System switched on, gas supply switched on
Red	Gas supply switched off, triggered by sloping position or excessive acceleration, e.g. in the event of an accident
Yellow	System switched on, gas supply switched on, primary bottle empty
Flashes yellow	Self-check, for approx. 2 seconds, after switching on
Flashes red once	Valve not connected to control unit or internal error
Flashes red twice	Overvoltage determined, gas supply interrupted
Flashes red three times	Undervoltage determined, gas supply interrupted

Putting into operation:

- Open the regulator taps of the gas bottles (Fig. 110,7).
- Press the release buttons (Fig. 110,6) successively for 10 seconds.
- Use the knob (Fig. 110,3) on the reversing valve (Fig. 110,4) to select the gas bottle which is to be the primary source of gas (primary bottle). Always turn the knob as far as it will go.
- Switch on the switching facility on the operating unit. For this, set the rocker switch (Fig. 111,2 or Fig. 112,2) to "ON". The reversing valve is now deaerated. The indicator lamp (Fig. 111,1 or Fig. 112,1) flashes yellow (system test) and lights up green.

Switching off:

- Set the rocker switch (Fig. 111,2 or Fig. 112,2) to "OFF". The indicator lamp (Fig. 111,1 or Fig. 112,1) goes out.
- Close the regulator taps of the gas bottles (Fig. 110,7).



► When changing gas bottles, do not smoke or create any open fire.

Changing gas bottles:

- Turn the knob on the reversing valve. The display is green again. Should the display stay red the reserve bottle is also empty and has to be changed as well.
- Close regulator tap on the empty gas bottle.
- Unscrew the gas tube of the gas bottle.
- Release the fixing belts and remove the gas bottle.
- Place a new gas bottle in the gas bottle compartment.
- Fix gas bottle in place with the fixing belts.
- Connect the full gas bottle to the gas tube.
- Open regulator tap on the gas bottle.
- Press the release button for 10 seconds.
- Turn the knob on the reversing valve to the changed bottle. Open the release button when the display is green.
- Set the knob on the reversing valve with a half-turn, so that the newly replaced gas bottle will serve as a reserve bottle.



Chapter overview

This chapter contains instructions regarding the electrical system of the caravan.

The instructions address the following topics:

- safety
- explanations of terms relating to the battery
- 12 V power supply
- power supply unit
- battery main switch
- electric kit
- 230 V power supply
- connection to the 230 V power supply
- fuse rating
- towing vehicle connection
- external socket
- electrical wiring

The operation of the electrical appliances of the housing body is described in chapter 9.

8.1 General safety instructions



► Only allow qualified personnel to work on the electrical system.

The vehicle is a safe place during a storm (Faraday cage). However, to protect the electrical devices, disconnect the 230 V connection and retract the antennae as a precaution.

8.2 Terms

Capacity Capacity refers to the amount of electricity which can be stored in a battery. The capacity of a battery is given in ampere hours (Ah). The so-called K20 value is normally used.

The K20 value indicates how much current a battery is able to dispense over a time period of 20 hours without causing damage, or how much current is required to charge a flat battery within 20 hours.

For example, if a battery can dispense 4 amps for 20 hours, then it has a capacity of $4 \text{ A} \times 20 \text{ h} = 80 \text{ Ah}$.

If more current flows, the capacity of the battery reduces proportionately. External influences, such as temperature and age may alter the storage capacity of the battery. Capacity details refer to new batteries operating at room temperature.

8.3 12 V power supply



- ▷ If you use the battery of the towing vehicle to provide power for the caravan, bear in mind that the battery capacity is restricted. If you place too great a burden on the battery, this may lead to starting difficulties.
- ▷ Always disconnect the electrical connection between the towing vehicle and the caravan before the caravan is connected to the local power supply. In order to carry this out, disconnect the plug from towing vehicle socket.

When the caravan is not connected to the 230 V power supply, 12 V power supply is performed by the starter battery of the connected towing vehicle or by the living area battery (electric kit). The starter battery has a limited power supply only. For this reason, the electrical appliances should not be operated for a long time without using the 230 V power supply when the engine of the towing vehicle is switched off.

If the caravan is electrically connected to the towing vehicle and the vehicle engine is running, the living area battery is charged by the vehicle generator (electric kit).

8.3.1 Power supply unit CSV 300



- ▷ Do not cover the ventilation slots on the power supply unit. Danger of overheating.

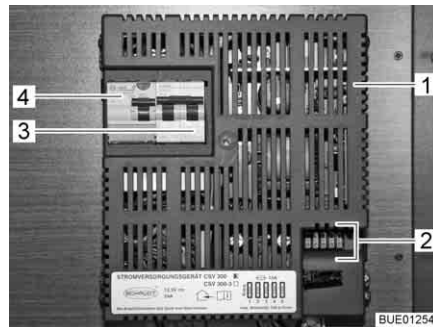

- 1 Power supply unit
- 2 Flat fuses
- 3 Two-pole automatic circuit breaker
- 4 Fault current protection switch

Fig. 113 Power supply unit CSV 300

Functions

The power supply unit distributes the current to the 12 V circuits and secures them.

If the vehicle is **not** connected to the 230 V supply, the requisite power supply is provided by the battery of the towing vehicle, as long as contact 9 "constant positive" is connected to the towing vehicle socket (see connection diagram at the end of this chapter). The 12 V living area lamps and the 12 V plug sockets can be used, with the exception of the TV output plug socket.

Devices with a maximum of 10 A can be connected to the sockets.

If the vehicle is connected to the 230 V power supply, the power supply unit switches the power supply in the living area automatically from the towing vehicle battery to mains operation. The internal power pack in the power supply unit provides 12 V plug sockets and 12 V appliances with power.



- ▷ The power supply unit is not used to charge the starter battery of the towing vehicle.

Position

The power supply unit (Fig. 113) is installed in the wardrobe.

Thermal cut-out

If the power supply unit becomes too hot during operation due to high ambient temperatures or insufficient ventilation, the power pack reduces the power output. As a result, the activated appliances which are connected to the power supply unit are supplied with a lower voltage than 12 V. If the power supply unit is still too warm, switch it off completely. If this over-temperature protection (thermal cut-out) is activated, improve the ventilation of the power supply unit and reduce the number of 12 V appliances that are switched on.



▷ Further information can be obtained in the manufacturer's instruction manual.

8.4 Battery main switch

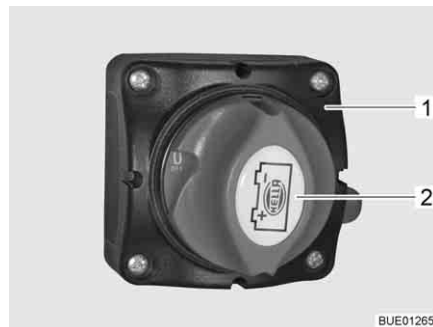

Fig. 114 Battery main switch, "OFF" position



Fig. 115 Battery main switch, "ON" position

To completely isolate the 12 V power supply, turn off the battery main switch (Fig. 114,1).

Switching off:

- Turn the rotary switch (Fig. 114,2) by a quarter turn anticlockwise to the "OFF" position. The 12 V living area power supply is switched off.

Switching on:

- Turn the rotary switch (Fig. 115,1) by a quarter turn clockwise to the "ON" position. The 12 V living area power supply is switched on.

8.5 Electric kit (special equipment)

Scope

The following components belong to the electric kit:

- Battery 12 V, 90 or 110 Ah
- Power supply unit with charging function for the living area battery
- Panel

8.5.1 Living area battery



- ▷ The living area battery may not be opened.
- ▷ Use only the built-in power supply unit to load the living area battery.
- ▷ After the trip, charge the living area battery fully.
- ▷ Before a temporary lay-up, charge the battery fully.
- ▷ For long periods of inactivity (4 weeks or more), either disconnect the living area battery or recharge it regularly.



- ▷ When the living area battery is changed, only use batteries of the same type and the same capacity.
- ▷ Before disconnecting or connecting the terminals of the living area battery, switch off the engine of the towing vehicle as well as the 230 V and 12 V power supplies and all appliances. Danger of short circuit!
- ▷ If the living area battery is disconnected and the caravan and towing vehicle are connected electrically, do not apply the ignition. There is a danger of short circuit from exposed cable ends.



- ▷ If possible, begin the trip with a fully charged living area battery. Therefore, charge the living area battery before starting the trip.
- ▷ During the trip, use every available opportunity to charge the living area battery.
- ▷ The battery is maintenance-free. Maintenance-free means:
 - It is not necessary to check the acid level.
 - It is not necessary to lubricate the battery poles.
 - It is not necessary to refill the distilled water.
 Even a maintenance-free battery must be charged regularly.

When the vehicle is not connected to the 230 V power supply or the 230 V power supply is switched off, the living area battery supplies the living area with 12 V DC. The living area battery has a limited power supply only. For this reason, electrical appliances such as the radio and the lights should not be operated for a long time without using the 230 V power supply.

Discharging

The living area battery is discharged by the closed circuit current which some electrical appliances continuously require.



- ▷ Total discharge damages the battery.
- ▷ Recharge battery in good time.

Even a fully loaded living area battery can be fully discharged by inactive appliances (e.g. clock or indicator lamps) after an extended period.

Low temperatures outside reduce the capacity available.

The self-discharge rate of the battery is also dependant on temperature. At 20 to 25 °C the self-discharge rate is approx. 3 % of the capacity per month. The self-discharge rate will increase with rising temperatures: At 35 °C the self-discharge rate is approx. 20 % of the capacity per month.

An older battery no longer has the complete capacity available.

The higher the number of active electrical appliances, the faster the energy of the living area battery is consumed.

In order to prevent fast discharge of the living area battery, the refrigerator is operated on 12 V power supply only when the engine is running and when there is an electrical connection between the towing vehicle and caravan.

Charging

Only use the power supply unit to charge the living area battery. Therefore, connect the vehicle to a 230 V power supply system as often as possible.



- ▷ Charge the battery for at least 48 hours after a total discharge.
- ▷ At temperatures below 0 °C, a living area battery consumes less power. At approx. -15 °C, there will be no more power. The living area battery can no longer be charged.

The living area battery is recharged by the alternator of the towing vehicle if the caravan is connected electrically to the towing vehicle and the towing vehicle's engine is running.

Changing the battery

- ▶ The acid in the battery is poisonous and corrosive. Any contact with the skin or the eyes is to be avoided.
- ▶ In the event of contact with the skin or eyes, rinse immediately with clear water.
- ▶ Keep naked flames and possible sources of sparks away from the battery. Danger of explosion!



- ▷ When replacing the battery, only use the same type of battery (same capacity and voltage, cycle stability).

Changing the battery:

- Release negative (-) terminal clamp.
- Release positive (+) terminal clamp.
- Remove the battery.
- Put in a new battery.
- Connect the new battery in the reverse order.

**Installation location
(Nordic models)**

The living area battery is built into the bench seat.

8.5.2 Power supply unit CSV 409

- ▷ Do not cover the ventilation slots on the power supply unit. Danger of overheating.

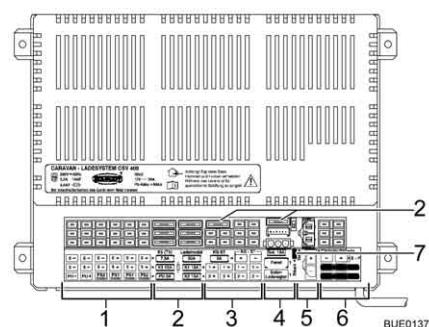

- 1 Connections: Consumer circuit 3 and 5 (awning light, TV), water pump
- 2 Fuses (see table in section 8.7)
- 3 Connections: Consumer circuits 1 and 2, refrigerator control
- 4 Connections: Solar charge regulator, panel
- 5 Connection: Living area battery
- 6 Connections: Towing vehicle, refrigerator load circuit

Fig. 116 Power supply unit CSV 409

Functions

The power supply unit performs the following tasks:

- The power supply unit charges the living area battery.
- The power supply unit distributes the current to the 12 V circuits and secures them. Devices with a maximum of 10 A can be connected to the sockets.

- The power supply unit provides connections for a solar charge regulator as well as other control and monitoring functions.
- The power supply unit separates the starter battery of the towing vehicle electrically from the living area battery of the caravan if there is an electric connection between the towing vehicle and the caravan and if the vehicle engine and the ignition are turned off. In this way the 12 V appliances of the caravan cannot discharge the starter battery of the towing vehicle.

The power supply unit only works in conjunction with a panel.

The power in the power supply unit (> 28 A) is divided into charging current and current to the appliances. The charging current is always just the portion that is not being used by any appliances. If the current to the appliances exceeds the current available, then the living area battery is discharged.

Position

The power supply unit is installed in the wardrobe or in a storage compartment.



- ▷ Further information can be obtained in the manufacturer's instruction manual.

Battery selector switch



- ▶ If the battery selector switch is set incorrectly, there is the danger of the formation of detonating (oxy-hydrogen gas). Danger of explosion!



- ▷ Incorrect setting of the battery selector switch damages the living area battery.
- ▷ The factory settings of the battery selector switch must not be changed.

Charging the battery

During mobile operation, the alternator of the towing vehicle charges the living area battery. If the engine and the ignition of the towing vehicle are cut off, then the power supply unit disconnects the starter battery electrically from the living area battery so that it is not possible to discharge the starter battery of the towing vehicle by using 12 V living area appliances.

When the vehicle is connected to the 230 V power supply, the living area battery is charged by the power supply unit.



- ▷ The power supply unit is not used to charge the starter battery of the towing vehicle.

8.5.3 Panel LT 408

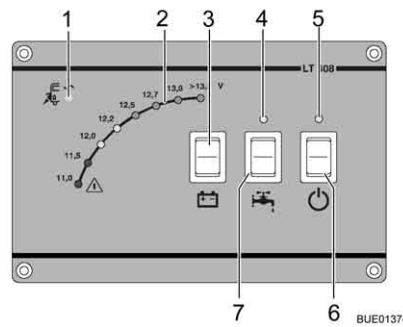

- 1 230 V indicator lamp
- 2 Display V
- 3 Button for reading the battery voltage of the living area battery
- 4 Indicator lamp for water pump
- 5 Indicator lamp for the 12 V power supply for the living area
- 6 12 V main switch
- 7 Rocker switch for water pump

Fig. 117 Panel LT 408

230 V indicator lamp

The yellow 230 V indicator lamp (Fig. 117,1) is on whenever line voltage is available at the power supply unit input.

Display V for battery voltage

The LEDs for display V (Fig. 117,2) indicate the battery voltage of the living area battery.

Displays:

- Press the button (Fig. 117,3) at the top or bottom: The battery voltage of the living area battery is displayed.

The tables below will help you correctly interpret the displayed battery voltage of the living area battery.

Battery voltage (values during operation)	Mobile operation (vehicle moving, no 230 V connection)	Battery operation (vehicle stationary, no 230 V connection)	Power operation (vehicle stationary, 230 V connection)
Less than 11 V Danger of total discharge	No charging via the alternator	If appliances are switched off: Battery flat	No charging by the CSV
	12 V power supply overload	If appliances are switched on: Battery overload	12 V power supply overload
11.5 V to 13 V	No charging via the alternator ¹⁾	Normal range	No charging by the CSV ¹⁾
	12 V power supply overload ¹⁾		12 V power supply overload ¹⁾
13.5 V or more	Battery being charged	Occurs only briefly after charging	Battery being charged

¹⁾ If the voltage does not exceed this range for several hours.

Values for off-load voltage	Charging condition of the battery
Less than 12 V	Discharge or totally discharge
12.2 V	25 %
12.5 V	50 %
More than 12.7 V	100 %



- ▷ Total discharge causes irreparable damage to the battery.



- ▷ Measure the off-load voltage preferably several hours after the previous charging (e.g. in the morning) and not directly after a current drain.

12 V main switch

The 12 V main switch (Fig. 117,6) switches the panel and the 12 V power supply of the living area on and off.

Switching on:

- Press the upper part of the rocker switch (Fig. 117,6): The 12 V living area power supply is switched on. Indicator lamp (Fig. 117,5) lights up yellow.

Switching off:

- Press the lower part of the rocker switch (Fig. 117,6): The 12 V living area power supply is switched off. The indicator lamp (Fig. 117,5) goes out.



- ▷ When leaving the vehicle, switch off the main 12 V power supply at the panel. This prevents any unnecessary discharge of the living area battery.
- ▷ The refrigerator control takes power from the battery capacity, even if the 12 V main switch is switched off. Therefore disconnect the living area battery from the 12 V power supply, if the vehicle will not be used for a long period of time.

12 V indicator lamp

The 12 V indicator lamp (Fig. 117,5) lights up yellow whenever the 12 V main switch (Fig. 117,6) is switched on.

Switch for water pump

The button for the water pump (Fig. 117,7) switches the water supply on and off.

Switching on:

- Press the upper part of the rocker switch (Fig. 117,7): The water supply is ON. Indicator lamp (Fig. 117,4) lights up yellow.

Switching off:

- Press the lower part of the rocker switch (Fig. 117,7): The water supply is OFF.



- ▷ If the vehicle is not connected to the 230 V power supply and the water pump is not used for a longer period of time: Switch off the power supply for the water pump. The pump relay uses around 4 Ah current each day.

Indicator lamp for water pump

The indicator lamp (Fig. 117,4) lights up yellow whenever the switch for the water pump (Fig. 117,7) is switched on.

8.5.4 Connection diagrams

**Power supply unit
CSV 409**

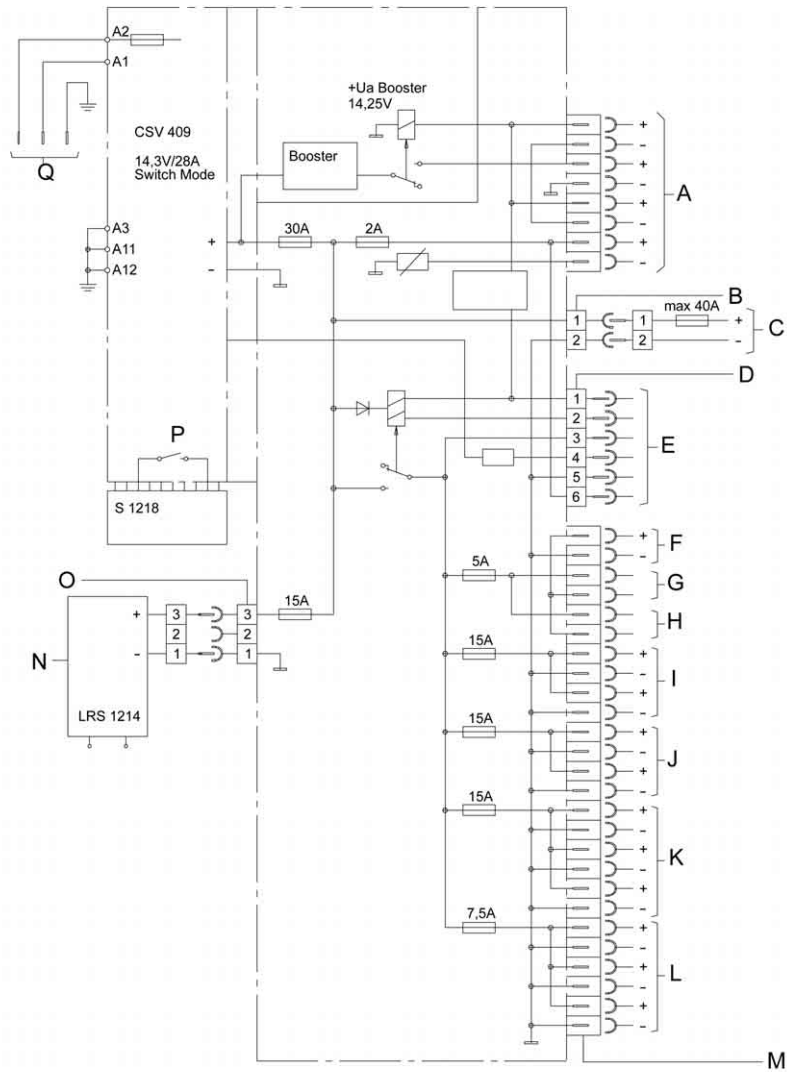

BUE01377

Fig. 118 Connection diagram

A	Connections: Towing vehicle, refrigerator load circuit
1	+ Caravan coupling – 12 V switched
2	– Caravan coupling – switched to 12 V
3	+ Caravan coupling – 12 V steady plus
4	– Caravan coupling – to 12 V steady plus
5	+ Refrigerator cartridge, fuse in vehicle
6	– Refrigerator cartridge, fuse in vehicle
7	+ Refrigerator control
8	– Refrigerator control
B	Molex Minifit SR-F
C	Living area battery
D	Pin header MSFQ/0 6Fh
E	Connections panel
1	12 V Off white
2	12 V On green
3	12 V control
4	Mains check
5	– 12 V brown
6	+ 12 V brown
F	Pump
G	Pump switch 1
H	Pump switch 2
I	Circuit 1
J	Circuit 2
K	Circuit 3
L	Circuit 5
1	+ Awning light
2	– Awning light
3	+ TV
4	– TV
5	+ Spare
6	– Spare
M	Connector LF-PA 401 6.3x0.8 - 32-pin
N	Solar charge regulator LRS 1214
O	MNL-connector socket-3F
P	Changeover switch "Blei-Säure/Blei-Gel" (lead-acid/dryfill)
Q	Connector cable 6.3x0.8 3 G 1.5 L = 1.2 m 230 V~ 50 Hz

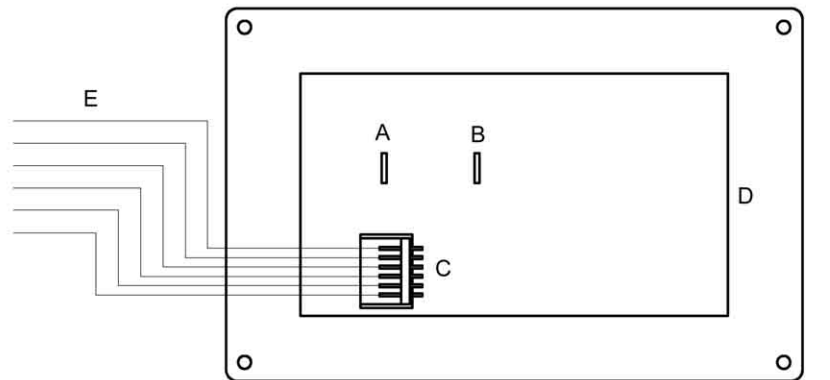
Panel

BUE01378

Fig. 119 Connection diagram

A	Flat plug 6.3 mm Switched supply voltage to water pump
B	Flat plug 6.3 mm Voltage supply for water pump - inlet
C	MSFWQ/0 6-pin
D	Printed circuit board
E	Connections battery charger
1	12 V Off white
2	12 V On green
3	12 V control
4	Mains check
5	- 12 V brown
6	+ 12 V brown

8.6 230 V power supply



► Only allow qualified personnel to work on the electrical system.

The 230 V power supply provides electricity for:

- sockets with earth contact for appliances with maximum 16 A
- refrigerator
- power supply unit

The electrical appliances connected to the 12 V power supply of the living area are supplied by the power supply unit or living area battery (electric kit).

Connect the vehicle to an external 230 V power supply system as often as possible. If a living area battery is installed, this is automatically charged via a charger module (electric kit).

8.6.1 230 V connection



- ▷ Overvoltage can damage connected devices. Overvoltage can be caused by lightning, irregular voltage sources (e.g. petrol-operated generators) or power connections on ferries for example.

Requirements concerning the 230 V connection

- The connecting cable, the plug connectors at the point of supply and the plug connector to the vehicle must comply with IEC 60309. The standard designation for the plug connectors is "CEE blue".
- Use H07RN-F rubber sheathed cable with a minimum cable cross-section of 2.5 mm² and a maximum length of 25 m.
- Earth contact connectors (safety) are not permitted. The interconnection of CEE/safety adapters is also prohibited.

8.6.2 Connecting the 230 V power supply



- ▶ The external 230 V power supply must be protected by fuse with a fault current protection switch (FI-switch, 30 mA).
- ▶ To prevent overheating, the cable must be fully uncoiled from the cable reel.
- ▶ In case of doubt or if the 230 V supply is not available or is faulty, contact the operator of the power supply device.



- ▷ Always disconnect the electrical connection between the towing vehicle and the caravan before the caravan is connected to the local power supply. In order to carry this out, disconnect the plug from towing vehicle socket.



- ▷ The 230 V connection in the vehicle is equipped with a fault current protection switch (FI-switch).
- ▷ For the connection points on camp sites (camping distributors) fault current protection switches (FI-switches, 30 mA) are obligatory.

The vehicle can be connected to an external 230 V power supply.

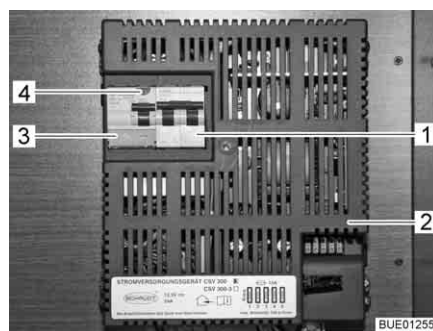

Fig. 120 230 V fuse box with safety cut-out and FI-switch



Fig. 121 230 V connection on vehicle

Connecting the vehicle:

- Check whether the power supply device is suitable regarding connection, voltage, frequency and current.
- Check whether the cables and connections are suitable.
- Check the plug connectors and cables for visible damage.
- Switch off the safety cut-out (Fig. 120,1) in the fuse box (Fig. 120,2).

- Open the cover of the 230 V connection on the vehicle (Fig. 121) and insert the plug connector. Ensure that the detent of the spring-mounted pivoting cover is engaged in position.
- Plug the connector of the connecting cable into the socket of the power supply device. Ensure that the detent of the spring-mounted pivoting cover is engaged in position.
- Switch on the safety cut-out in the fuse box.

Checking the fault current protection switch:

- When the vehicle is connected to the 230 V supply, press the test button (Fig. 120,4) of the fault current protection switch (FI-switch) (Fig. 120,3) in the fuse box (Fig. 120,2). The fault current protection switch must trip.
- Switch the fault current protection switch back on again.

Unplugging the connection:

- Switch off the safety cut-out (Fig. 120,1) in the fuse box (Fig. 120,2).
- Loosen the detent on the power supply device and unplug the connection cable from the socket.
- Loosen the detent on the vehicle, unplug the plug connector and close the cover of the 230 V connection.

8.7 Fuses



- ▶ Only replace defective fuses when the cause of the defect is known and has been remedied.
- ▶ Replace defective fuses only after the power supply has been turned off.
- ▶ Never bridge or repair fuses.
- ▶ Only replace faulty fuses with a new fuse with the same rating.

8.7.1 12 V fuses

The appliances connected to the 12 V power supply in the living area are fused individually. The fuses are accessible at the power supply unit or in a fuse holder close to the power supply unit.

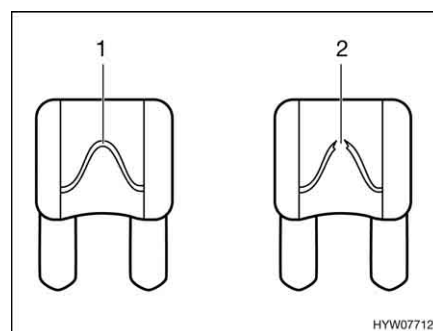

- 1 Unbroken fuse element
- 2 Broken fuse element

Fig. 122 12 V fuse

An intact 12 V fuse can be detected by the unbroken fuse element (Fig. 122,1). If the fuse element is broken (Fig. 122,2), change the fuse.

Before changing fuses, take the function, value and colour of the relevant fuses from the following specifications. When changing fuses, only use flat fuses with the values shown below.

Fuses on the power supply unit CSV 300

Function	Type of fuse	Value/colour
Fuse circuit 1	Flat fuse	15 A blue
Fuse circuit 2	Flat fuse	15 A blue
Fuse circuit 3	Flat fuse	15 A blue
Fuse circuit 4	Flat fuse	15 A blue
Fuse circuit 5	Flat fuse	15 A blue

Fuse for the refrigerator

The fuse is located in a fuse holder in the vicinity of the power supply unit unit.

- Type of fuse: Flat fuse 15 A/blue

Changing:

- Remove cover on the floor of the wardrobe.
- Replace fuse.
- Reattach cover once fuse has been replaced.

Fuses on the power supply unit CSV 409 (Electric kit)

Function	Value/colour
Circuit 5 (TV, awning light)	7.5 A brown
Circuit 3	15 A blue
Water pump	5 A light brown
Internal charger	30 A yellow
Circuit 1	15 A blue
Circuit 2	15 A blue
Refrigerator control	2 A grey
Solar	15 A blue

Fuse for the Thetford toilet (swivel toilet)

The fuse is located in the locker wall of the Thetford cassette.

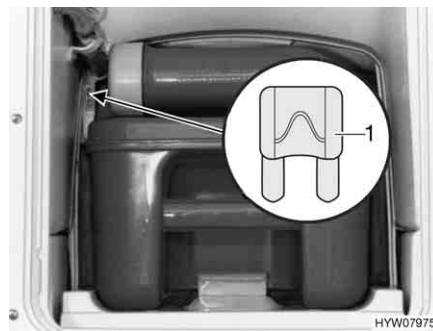

- 1 Flat fuse 3 A/purple

Fig. 123 Fuse for the Thetford toilet

Changing:

- Open the flap for the Thetford cassette on the outside of the vehicle.
- Pull out the Thetford cassette completely.
- Replace fuse (Fig. 123,1).

Fuse for the Thetford toilet (fixed seat)

The fuse is located in the locker wall of the Thetford cassette.

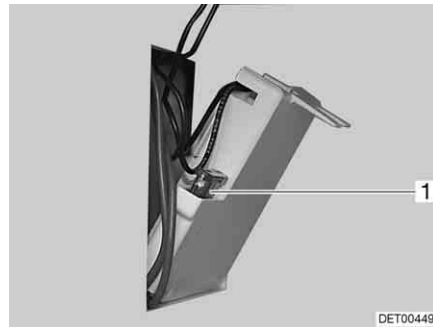

1 Flat fuse 3 A/purple

Fig. 124 Fuse for the Thetford toilet

Changing:

- Open the flap for the Thetford cassette on the outside of the vehicle.
- Remove the Thetford cassette and swing out the flap in the housing panel.
- Replace fuse (Fig. 124,1).

Fuses for heater for waste water pipes

The fuses are located on the regulator (Fig. 125,1).

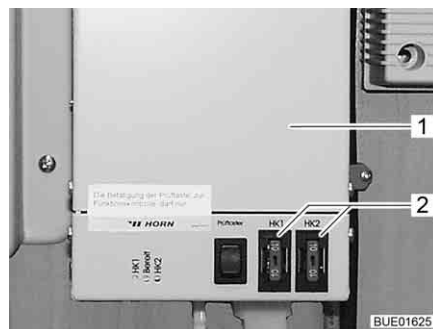

Fig. 125 Heater regulation for waste water pipes

Changing:

- Switch the heater off.
- Replace fuse (Fig. 125,2).

8.7.2 230 V fuse



- ▷ Check the fault current protection switch for each connection to the 230 V power supply, at least once every 6 months.

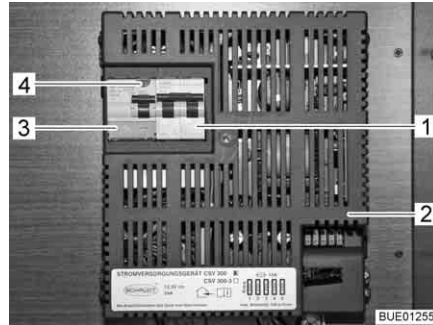

Fig. 126 230 V automatic circuit breaker and FI-switch (CSV 300)

A fault current protection switch (FI-switch) (Fig. 126,3) in the power supply unit CSV 300 (Fig. 126,2) protects the complete vehicle from fault current (0.03 A).

A downstream two-pole safety cut-out (Fig. 126,1) in the power supply unit protects the 230 V power supply.

Position The power supply unit is installed in the wardrobe.

Checking fault current protection switch:

- When the vehicle is connected to the 230 V power supply, press the test button (Fig. 126,4). The fault current protection switch (FI-switch) must trip.

8.8 Thirteen-pin plug connection diagram



- ▷ Note the colours of the connecting cable of the socket which is fitted to the towing vehicle. This makes any new connection which may be necessary easier.
- ▷ To connect the thirteen-pin plug to a seven-pin socket, use a commercially available adaptor.

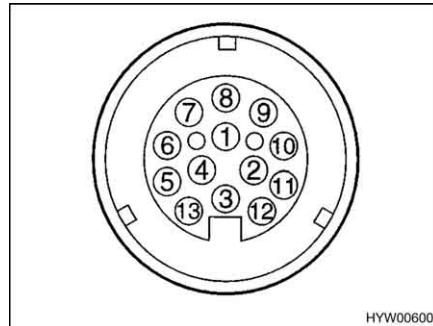

Fig. 127 Contact diagram of the thirteen-pin plug

Connection diagram

Contact no.	DIN specification	Function	Cable colour caravan	Cable colour plug	Cross section of the wire
1	L	Left direction indicator	Yellow	Yellow	1.5 mm ²
2	54 G	Fog tail light	Blue	Blue	1.5 mm ²
3 ¹⁾	31	Earth (contacts 1, 2, 4 - 8)	White	White	2.5 mm ²
4	R	Right direction indicator	Green	Green	1.5 mm ²
5	58 R	Right tail light, side marker light, clearance light, licence plate light	Brown	Brown	1.5 mm ²
6	54	Brake lights	Red	Red	1.5 mm ²
7	58 L	Left tail light, side marker light, clearance light, licence plate light	Black	Black	1.5 mm ²
8		Back-up light	Grey	Pink	1.5 mm ²
9		Constant positive	Blue (cable no. 78)	Orange	2.5 mm ²
10		Positive charging line	–	Grey	2.5 mm ²
11		Earth charging line	–	Black-white	2.5 mm ²
12		Not assigned	–	–	–
13 ¹⁾		Earth (contacts 9 - 12)	Brown (cable no. 78)	Red-white	2.5 mm ²

¹⁾ These earth cables may not be connected to electrical conductors on the trailer side.

8.9 External socket (special equipment)

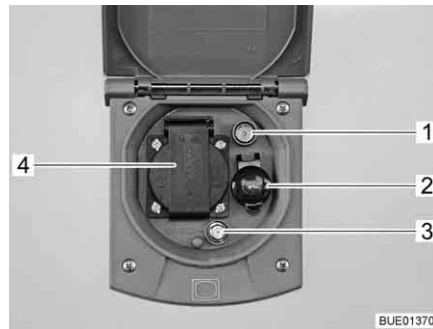

- 1 TV socket
- 2 12 V socket
- 3 SAT socket
- 4 230 V socket

Fig. 128 External socket

The 230 V socket and the 12 V socket can be used to power electrical devices in the awning.

Connection possibilities

TV socket and SAT socket offer various possibilities for TV operation:

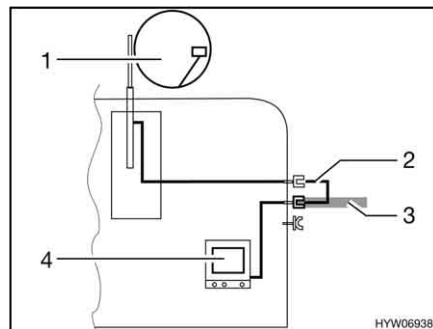

Fig. 129 TV inside the vehicle

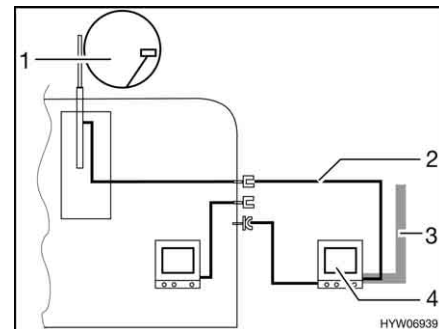
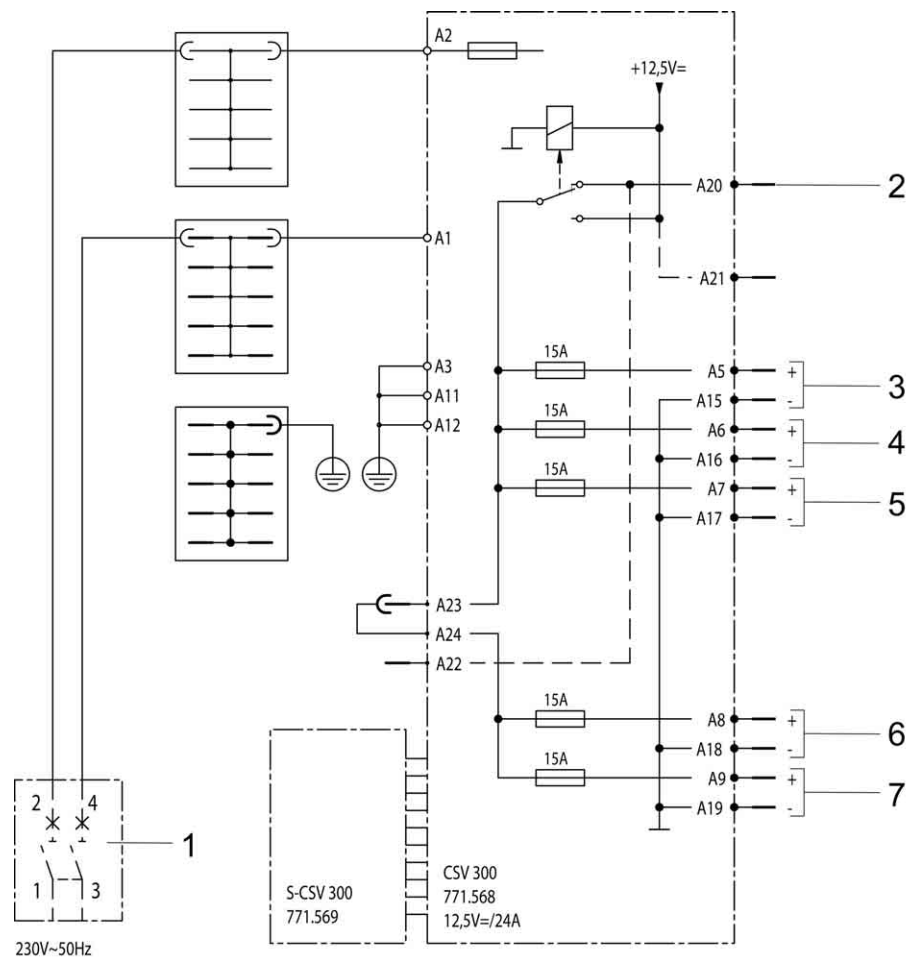

Fig. 130 TV in the awning

- TV inside the vehicle (Fig. 129,4): Connection to roof antenna (Fig. 129,1) with connection cable (Fig. 129,2)
- TV inside the vehicle (Fig. 129,4): Connection to external antenna (Fig. 129,3)
- TV inside the awning (Fig. 130,4): Connection to roof antenna (Fig. 130,1) with connection cable (Fig. 130,2)
- TV inside the awning (Fig. 130,4): Connection to external antenna (Fig. 130,3)

8.10 Circuit diagrams

8.10.1 Circuit diagram, interior



BUE00824

Fig. 131 Circuit diagram, interior (CSV 300)

- 1 230 V automatic circuit breaker
- 2 Battery towing vehicle (external fuse max. 15 A)
- 3 12 V output, circuit 1
- 4 12 V output, circuit 2
- 5 12 V output, circuit 3
- 6 12 V output, circuit 4
- 7 12 V output, circuit 5

8.10.2 Circuit diagram, exterior



▷ Cable installation can differ depending on the model.

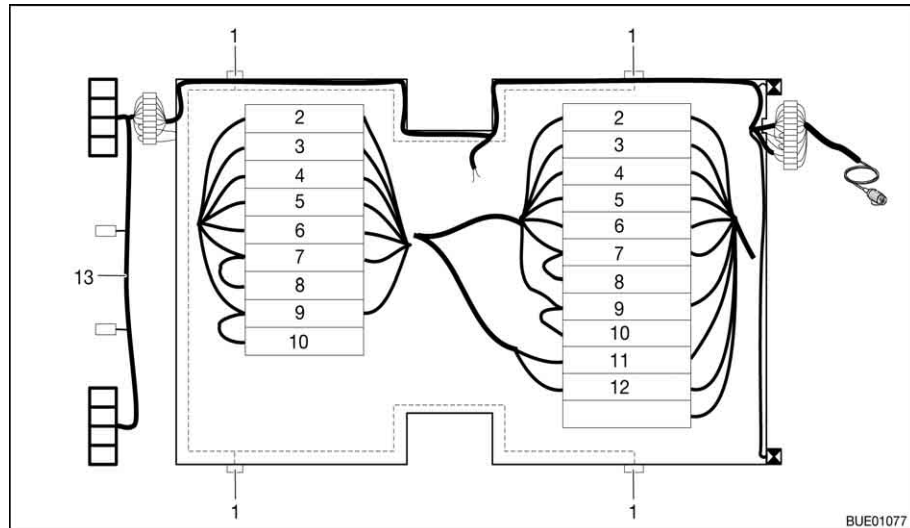

Fig. 132 Circuit diagram, exterior

- 1 Side marking light (number depends on type)
- 2 Left direction indicator (yellow)
- 3 Fog tail light (blue)
- 4 Earth 1 - 8 (white)
- 5 Right direction indicator (green)
- 6 Brake lights (red)
- 7 Right tail light (brown)
- 8 Right side marking lamps (brown)
- 9 Left tail light (black)
- 10 Left side marking lamps (black)
- 11 Constant positive (blue)
- 12 Earth 9 - 12 (brown)
- 13 Wiring harness, bumper (dependent on type)

Chapter overview

This chapter contains instructions regarding the appliances of the vehicle.

The instructions refer exclusively to the operation of the appliances.

Further information about the appliances can be found in the instruction manuals for the appliances, included separately with the vehicle.

The instructions address the following topics:

- heater
- boiler
- air conditioning unit
- gas cooker
- gas oven
- microwave oven
- extractor hood
- refrigerator

9.1 General



- ▷ The heat exchanger of the Truma hot-air heater has to be replaced after 30 years. Only the manufacturer of the heater or an authorised specialist workshop is allowed to replace the heat exchanger. The operator of the heater must see to it that the parts are replaced.
- ▷ For safety reasons, spare parts for pieces of heating appliances must correspond with manufacturer's instructions and be permitted by the manufacturer as a spare part. These spare parts may only be fitted by the manufacturer or an authorised specialist workshop.



- ▷ Further information can be obtained in the instruction manual for the respective appliance.

The heater, boiler, cooker and refrigerator are fitted depending on the model of the vehicle.

In this instruction manual a description is given only for the operation of the appliances and their particular features.

To operate gas appliances, first open the regulator tap on the gas bottle and the gas isolator tap corresponding to the appliance.

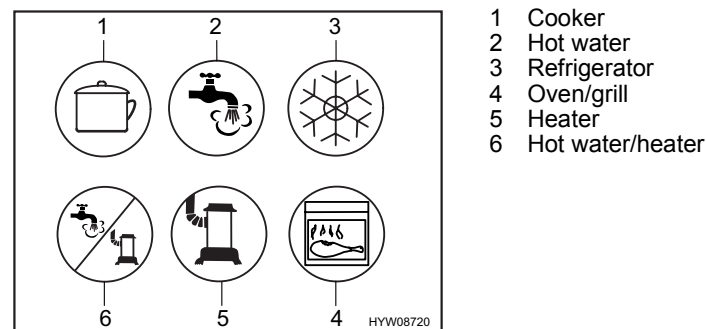

Fig. 133 Possible symbols for the gas isolator taps

9.2 Heater and boiler



- ▶ In winter, check that the waste gas vent on the vehicle roof is free of snow and ice before using the heater.
- ▶ Never let gas escape unburned due to danger of explosion.
- ▶ Never run the heater or the boiler in gas operation when refuelling, on ferries or in the garage. Danger of explosion!
- ▶ Never operate the heater or the boiler in gas operation in closed spaces (e. g. garages). Danger of poisoning and suffocation!
- ▶ If the circulation fan does not activate automatically, switch the circulation fan on from heating level 3 to 4. There is danger of overheating for the heater!
- ▶ Do not damage the exhaust gas pipe.
- ▶ The waste gas vent may neither be closed nor blocked.
- ▶ When camping in winter, the Truma waste gas vent extension should be used to prevent snow from choking the waste gas vent.
- ▶ Do not use the space behind the heater as a storage compartment.
- ▶ The water in the boiler can be heated up to 65 °C. Risk of scalding!



- ▷ Switch on the boiler and empty it if the vehicle is not used.
- ▷ Never use boiler when empty.
- ▷ If the boiler is not being used, empty it if there is any risk of frost.
- ▷ Only operate the boiler with the maximum temperature setting if you require a large quantity of warm water. This protects the boiler against the build-up of limescale.



- ▷ Do not use the water from the boiler as drinking water.

When lighting the heater for the first time a small amount of smoke and odour will occur. Immediately set the operating switch of the heater to its highest position. Open doors and windows and ventilate well. Smoke and odour will disappear by themselves after a while.

9.2.1 Models with waste gas vent on the right-hand side of the vehicle



- ▶ If the awning is put up and the heater is running in gas operation, exhaust gases from the heater can escape into the awning area. Danger of suffocation! Make sure the area is sufficiently ventilated.

9.2.2 To heat properly



Fig. 134 Air outlet nozzle of the hot air distribution

Hot air distribution

Several air outlet nozzles (Fig. 134) are built into the vehicle. Pipes conduct the warm air to the air outlet nozzles. Turn the air outlet nozzles in a suitable position so the air can escape as required.

Adjusting the air outlet nozzles

- Fully open: Full hot air stream
- Half or partially open: Reduced hot air stream

When five air outlet nozzles are completely opened, less warm air escapes through each nozzle. However, if only three air outlet nozzles are opened, more warm air flows out of each nozzle.

9.2.3 Alde hot water heater and boiler (partially special equipment)



- ▷ Never run hot-water heater without heating fluid. Observe notes in chapter 12.
- ▷ Never drill holes in the floor. This might damage the hot-water pipes.



- ▷ The circulating pump must always be turned on when the hot-water heater is in operation.
- ▷ We recommend to bleed the heating system after the initial heater operation and to check the glycol content. Observe notes in chapter 12.
- ▷ When the heater is turned on, it starts with the last settings used.
- ▷ Depending on the equipment, there is an underfloor heater in the driver's cabin.
- ▷ For further information, see the separate manufacturer's instruction manual and observe the maintenance instructions found in chapter 12.

The hot-water heater is installed at the bottom of the wardrobe or under the beds.

Operating unit The operating unit is divided into two sections:

- Display (touch screen)
- Operating buttons

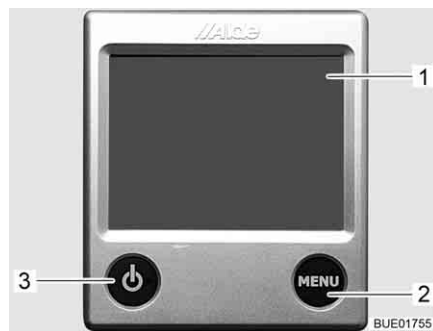

- 1 Display (touch screen)
- 2 "Menu" button
- 3 "On/Off" button

Fig. 135 Operating unit for hot-water heater



- ▷ When no button is pressed, the operating unit automatically switches to home position after two minutes.
- ▷ Changes to the settings are saved automatically after 10 seconds.

Operating buttons

The operating buttons have the following functions:

Pos. in Fig. 135	Button	Function
2	MENU	Open adjustment menu
3		Activate heating

Display

The display (Fig. 135,1) is designed as a touch screen. Touching the symbols calls up the relevant function.



Fig. 136 Start screen

Start screen The Start screen appears on the display after the heater is switched on. The Start screen contains the following information:

Symbol	Signification
	This symbol appears when the circulating pump is activated
	This symbol appears when a switching facility for gas cylinders is activated
	This symbol appears when a voltage of 230 V is present at the heater
	The internal temperature is displayed next to this symbol
	The external temperature is displayed next to this symbol if an external sensor is fitted



Adjustment menu The "MENU" button calls up the adjustment menu. The meanings of the individual symbols are described in the following table.



Fig. 137 Adjustment menu

The values can be increased or reduced via the "+" or "-" symbols.

Symbol	Signification
	Setting the desired temperature (from +5 °C to +30 °C)
	Setting the water temperature in the boiler
	Setting the heat output in electrical operation
	Heater button in gas operation On/Off

Symbol	Signification
	Tool menu button
	AC button for switching on the automatic air conditioning (only visible when the Truma Aventa air conditioning system is installed)
	Button for activated functions

Tool menus

The various heater functions can be called up and adjusted via the tool menus. The arrow symbols are used to change between the menus. The meanings of the individual symbols are described in the manufacturer's instruction manual.



Selecting the operating mode

The hot-water heater can be operated with the following energy sources:

- Gas operation
- 230 V electrical operation
- Gas and 230 V electrical operation

The operating mode is selected from the operating unit.

Selecting gas operation:

- Press "" button. The button lights up green. The gas operation is activated.
- Press "" button again. The button lights up blue. The gas operation is switched off.

Selecting 230 V electrical operation:

- Press the "+" button next to the "" symbol until the desired heat output is reached.



- ▷ Select the output level during 230 V electrical operation in such a way that it corresponds to the 230 V connection protection:

- Level 1 (1 kW) at 6 A
- Level 2 (2 kW) at 10 A
- Level 3 (3 kW) at 16 A

Selecting gas and 230 V electrical operation:



- Select gas operation and 230 V electrical operation on the operating unit.
- ▷ If gas and 230 V electrical operation is selected and if the vehicle is connected to the 230 V power supply, then the hot-water heater at first only operates in 230 V electric operation. Only if the heat output is insufficient does the gas operation also automatically switch on.
- ▷ The gas operation is only possible when the regulator tap on the gas bottle and the gas isolator tap are opened.
- ▷ 230 V electrical operation is only possible when the vehicle is connected to the 230 V power supply.

When the heater is turned on, it starts with the last set operating mode.

Switching on the heater:

- Press "" button. The Start screen appears in the display. The heater starts automatically.

Switching off the heater:

- Press "" button. The heater is turned off.

Setting the rotational speed of the circulating pump

- ▷ The hot-water heater is equipped with a very powerful pump. In smaller vehicles, the pump can only be operated at full power if the pipes are bled. Otherwise, this will increase wear; loud operating noises are the result.



Fig. 138 Speed reduction

The rotational speed of the circulating pump can be set with the control knob (Fig. 138,2). At a lower rotary speed, the operating sounds of the pump are quieter.

The control knob is located on the circulating pump (Fig. 138,1).

Setting the output:

- Turn the control knob (Fig. 138,2) in an anticlockwise direction. The output is reduced.
- Rotate the control knob in a clockwise direction. The output is increased.

3-way valve

For models with a rear bed, a 3-way valve is connected to the hot water heater circulation. The 3-way valve is installed in the rear garage. The 3-way valve can be accessed via an external flap.



Fig. 139 3-way valve

Opening the heat circulation in the rear area:

- Set the lever (Fig. 139,2) of the 3-way valve (Fig. 139,1) parallel to the straight flow direction (Fig. 139).

Locking the heat circulation in the rear area:

- Set the lever (Fig. 139,2) of the 3-way valve (Fig. 139,1) transverse to the straight flow direction.

Alde heat exchanger



- ▷ The heat exchanger only works when the vehicle engine is running.
- ▷ If the heat exchanger is not being used (as in the summer), the heat exchanger on the stopcock should be shut off.

The heat exchanger can be used to heat the living area of the vehicle during travel without operating the hot-water heater in the living area.

The heat exchanger is connected to the vehicle engine's cooling circuit and thus has the same function as the vehicle heater.

Heat output is set with the living area's heating regulator.

The heat exchanger stopcock is located directly on the exchanger.

Turning on the vehicle heating by heat exchanger:

- Make sure the heat exchanger stopcock is open.
- Press the "⏻" button (Fig. 135,3) on the operating unit (Fig. 135). The Start screen appears in the display. That turns on the heating control system and makes the circulating pump run.
- Press "MENU" button (Fig. 135,2).
- Turn off gas operation or 230 V electrical operation (if turned on).
- Set the desired room temperature. To do that, press the "+" or "-" button next to the "🏠" symbol.

Turning off the vehicle heating by heat exchanger:

- Press the "⏻" button (Fig. 135,3) on the operating unit (Fig. 135).



Fig. 140 Alde heat exchanger

Turning on: ■ Set stopcock handle (Fig. 140,1) parallel to the pipe.

Turning off: ■ Set drain cock handle (Fig. 140,1) at a right angle to the pipe.

Alde auxiliary circulating pump (special equipment)

- ▷ The auxiliary circulating pump works only if the heat exchanger has been installed and started, and the hot-water heater is running.

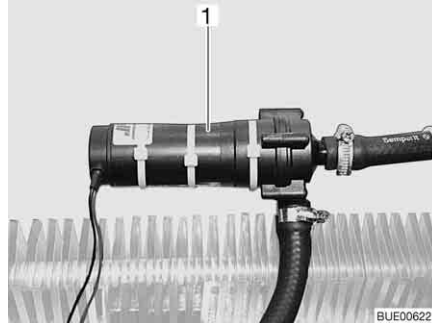

Fig. 141 Auxiliary circulating pump

The auxiliary circulating pump (Fig. 141,1) can be used to heat the vehicle engine when parked.

The auxiliary circulating pump is connected to the vehicle engine's cooling circuit and thus functions as an engine heater.



Fig. 142 Operating switch for auxiliary circulating pump

The auxiliary circulating pump switch (Fig. 142) is located next to the hot-water heater operating unit. The yellow indicator lamp illuminates when the pump is operated.

Filling/emptying the boiler

The boiler can be supplied with water from the water tank.



- ▷ Depending on the model, the vehicle is fitted with one or two drain cocks.

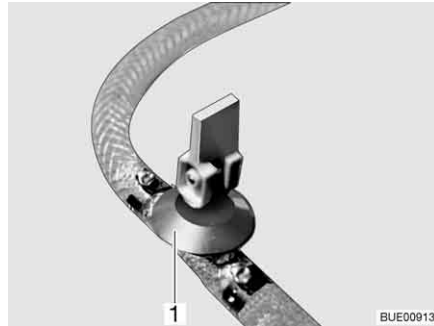

Fig. 143 Drain cock

Filling the boiler with water:

- Close the drain cock(s). Position the rocking lever (Fig. 143,1) horizontally.
- Switch on 12 V power supply on the panel.
- Set all the water taps to "Hot" and open them. The water pump is turned on. The warm water pipes are filled with water.
- Keep the taps open until the water flowing out of the taps has no bubbles in it. This is the only way to ensure that the boiler is full of water.
- Close all water taps.

Emptying the boiler:

- Switch off the boiler.
- Open all water taps and set to the central position.
- Open drain cock(s) (Fig. 143). To do so, set the rocking lever (Fig. 143,1) in a vertical position. The boiler is drained to the outside.
- Check whether the water has been drained completely from the boiler (approx. 10 litres).



- ▷ For further information, see the separate manufacturer's instruction manual and observe the maintenance instructions found in chapter 12.

Position of the drain cock(s)

See chapter 16.

9.2.4 Trumatic S 3004/S 5004 hot-air heater



- ▶ In case of problems wait for three minutes before trying again.



- ▷ The heater and fan can also be operated independently of each other. This means that the fan can also be used without the heater for air circulation.
- ▷ To ensure that warm air is distributed quickly and evenly, switch on the fan when the heater is in operation. This also reduces the surface temperature of the outlet grille.
- ▷ Type S 5004 is equipped with a second fan and has a greater output.

The heater is equipped with an adjustable fan and is controlled via a thermostat.

Depending on the model and equipment level, the type S 3004 or type S 5004 may be fitted.

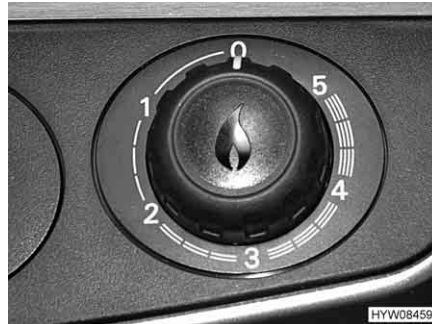

Fig. 144 Hot-air heater control knob

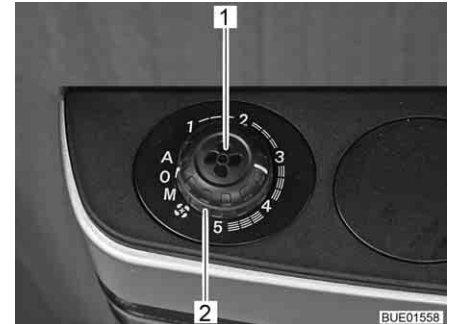

Fig. 145 Knob and rotary switch for fan control

Switching on:

- Open the regulator tap on the gas bottle and the gas isolator tap "Heater".
- Turn control knob on the heater to the required position and press it firmly. The automatic ignition produces ignition sparks. A clicking noise can be heard.
- Keep the control knob pressed until the flame burns. The burning of the flame can be checked in the inspection window in the heater cover.
- Hold the control knob down for a further 10 seconds, until the ignition fuse starts up.



- ▷ The automatic ignition ignites until the gas is burning. If there is no gas, it will continue to spark until the battery in the automatic ignition is empty. When the heater is not required, set the control knob to "0" to avoid the battery in the automatic ignition running flat.
- ▷ If the clicking noise cannot be heard at all or only at intervals of several seconds during ignition: Change the battery in the automatic ignition.
- ▷ Insert a new batteries before the start of every heating season.

Switching off:

- Turn the control knob on the heater to "0". The automatic ignition is switched off simultaneously.
- Close the gas isolator tap "Heater" and the regulator tap on the gas bottle.

Fan operating modes

Switch position	Operating mode	Function
A	Automatic	The required fan output is regulated electronically
M	Manual	The fan output is set manually using the knob (Fig. 145,1)
	Booster level	The fan works at maximum output (for maximum air flow)

Switching on the fan:

- Set the rotary switch (Fig. 145,2) to the required operating mode.

Switching off the fan:

- Turn the rotary switch (Fig. 145,2) to "0".

Automatic ignition

The automatic ignition ignites until the gas is burning or the battery in the automatic ignition is empty.

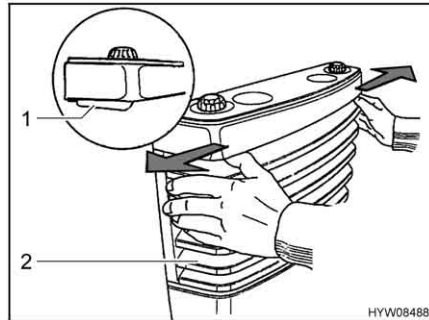

Fig. 146 Removing heater cover

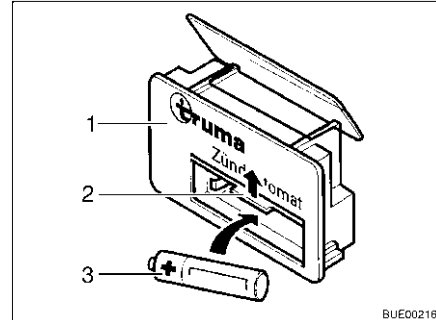

Fig. 147 Automatic ignition

Changing the battery on the automatic ignition:

- Ensure that the heater is switched off and cooled down.
- Remove heater cover (Fig. 146,2). To do this, press the two locking levers (Fig. 146,1) to the outside at the same time and tip the cover forwards.
- Lift the heater cover out of the bottom brackets and remove it.
- Push battery chamber cover (Fig. 147,2) on the automatic ignition (Fig. 147,1) upward.
- Remove the old battery out of the battery chamber of the automatic ignition.
- Insert a new battery (Fig. 147,3) of the same type, correctly aligned (+/-), into the battery chamber of the automatic ignition. Only use temperature resistant (+70 °C) and leak-proof Mignon batteries.
- Close the battery chamber cover on the automatic ignition.

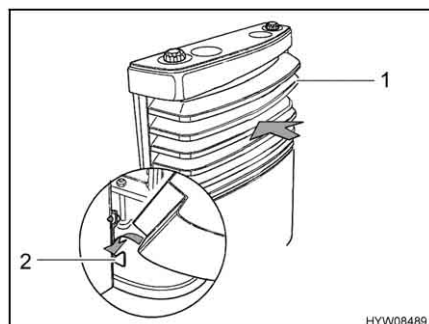

Fig. 148 Heater cover, lower brackets

- Mount the heater cover. To do this, place the heater cover (Fig. 148,1) on the lower brackets (Fig. 148,2).
 - Swivel the heater cover onto the heater and allow the heater cover to engage at the top.
- ▷ Further information can be obtained in the manufacturer's instruction manual.



9.2.5 Airmix comfort package (special equipment)

The air circulation fan can be installed on the floor or on the wall with the Airmix comfort package. This guarantees a particularly quiet running, since no noise transferring connection is made to the fitted cover of the heater.

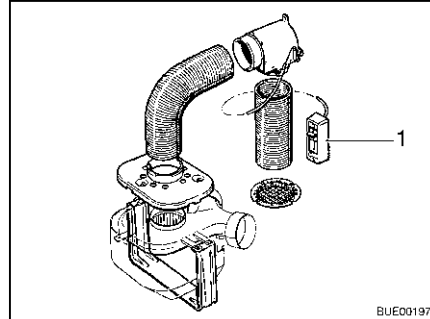

Fig. 149 Airmix comfort package

Fresh outside air is guided into the caravan by the Airmix.

Advantages of outside air are:

- Cooling effect in the summer
- Drying effect in the winter

The outside air can be mixed progressively with the inside air that has already been heated by adjusting the operating controls (Fig. 149,1).



- ▷ See installation instructions of the separate instruction manual for the Airmix comfort package.

9.2.6 Ultraheat additional electric heater (special equipment)

The Ultraheat additional electric heater is built-in to the hot-air heater. Therefore there are three heating options:

- Only the hot-air heater
- Hot-air heater and electric heater
- Only the electric heater

The vehicle can be heated more quickly with the additional electric heater.



- ▷ The additional electric heater only operates if the vehicle is connected to the 230 V power supply.
- ▷ If the heater is operated by electricity and gas simultaneously, the additional electric heater switches off to prevent possible overheating by the stronger gas burner.



- 1 Rotary switch
- 2 Off
- 3 Temperature control knob

Fig. 150 Operating unit for Ultraheat additional electric heater

- Switching on:**
- Connect the vehicle to the 230 V power supply (see section 8.6).
 - Turn the rotary switch (Fig. 150,1) to the desired output level (500, 1000 or 2000 W).
 - Turn temperature control knob (Fig. 150,3) to the desired output level.
- Switching off:**
- Turn the rotary switch (Fig. 150,1) to "0" (Fig. 150,2).

9.2.7 Warming unit for waste water pipes (special equipment)



- ▷ Always only press the test button briefly.



- ▷ The warming unit only functions when the vehicle is connected to a 230 V power supply.

In order to prevent waste water pipes freezing up, the waste water pipes can be electrically warmed.

When the warming unit is turned on, the temperature of the waste water pipes is monitored by temperature sensors. If the temperature falls below 5 °C, the heating elements are switched on and the waste water pipes are warmed. If the temperature rises above 7 °C, the heating elements are switched off again.

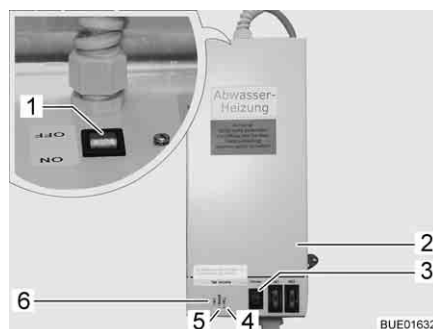

Fig. 151 Transformer with control unit

The 230 V AC/12 V DC transformer (Fig. 151,2) is installed in the wardrobe or in the storage area beneath the seating group, depending on the model.

The control unit is integrated in the transformer housing. The control lamps have the following meanings:

- Indicator lamp (Fig. 151,5) lights up in green: Regulation in operation
- Indicator lamps (Fig. 151,4 and 6) light up in red: Waste water pipes are warmed

A test button (Fig. 151,3) is integrated in the housing with which the control unit can be operated for a short time. By pressing the test button, the function of the warming unit can be tested, even if the ambient temperature is above 5 °C.

- Switching on:*
- Connect the vehicle to a 230 V power supply (see section 8.6.1).
 - Turn switch (Fig. 151,1) on the transformer (Fig. 151,2) to "ON".

- Switching off:*
- Turn switch (Fig. 151,1) on the transformer (Fig. 151,2) to "OFF".

9.2.8 Electrical floor warming unit (special equipment)



- ▶ On models with electrical floor warming unit, never drill holes in the floor or screw in any screws. Careful with sharp objects. There is danger of a power cut or a short circuit due to damage to a heater wire.



- ▷ Do not cover the transformer. Danger of overheating!



- ▷ The electrical floor warming unit only operates if the vehicle is connected to the 230 V power supply.
- ▷ The output of the electrical floor warming unit alone is not sufficient to heat the living area.



Fig. 152 Transformer for electrical floor warming unit



Fig. 153 Switch for electrical floor warming unit

The transformer (Fig. 152,1) for the electrical floor warming unit is installed either in the bench seat or in the bedding box, depending on the model.

- Switching on:*
- Connect the vehicle to the 230 V power supply (see chapter 8).
 - Press the rocker switch (Fig. 153,2). The indicator lamp (Fig. 153,1) on the switch is illuminated.

- Switching off:*
- Press the rocker switch (Fig. 153,2). The indicator lamp (Fig. 153,1) on the switch goes off.

After switching off, the floor remains warm for a while, due to residual heat.
If the transformer is overloaded, the overload protection is actuated. The pin (Fig. 152,2) jumps out.

Switching on overload protection:

- Press the pin (Fig. 152,2) on the overload protection when the transformer is cooled.

9.2.9 Truma boiler (special equipment)



- ▶ Remove cap from waste gas vent before using the Truma boiler.

Operating modes

The boiler has three operating modes:

- Gas operation
- 230 V electrical operation
- Combined operation

The operating mode is set with the operating controls.

The regulation of the water temperature in the boiler is only possible with gas operation.

Gas operation

The boiler is operated exclusively with gas.



- 1 Temperature control knob
- 2 Red indicator lamp "Fault"
- 3 Rotary switch
- 4 Off
- 5 On

Fig. 154 Operating unit for Truma boiler (gas operation)

Switching on:

- Remove cap from waste gas vent.
- Open the regulator tap on the gas bottle and the gas isolator tap "Boiler".
- Set the rotary switch (Fig. 154,3) to "▲" (Fig. 154,5). The green "Operation" indicator lamp illuminates the knob (Fig. 154,1).
- Adjust the knob (Fig. 154,1) to the required water temperature.

The red indicator lamp (Fig. 154,2) illuminates when there is a fault (see chapter 14).

Switching off:

- Set the rotary switch (Fig. 154,3) on the operating unit (Fig. 154) to "○" (Fig. 154,4).
- Close the gas isolator tap "Boiler" and the regulator tap on the gas bottle.
- Place cap on waste gas vent.

The red indicator lamp (Fig. 154,2) illuminates when there is a fault (see chapter 14).

230 V electrical operation

The boiler is operated exclusively with electricity.



- ▷ 230 V electrical operation is only possible when the vehicle is connected to the 230 V power supply.



Fig. 155 Flip switch for Truma boiler (230 V electrical operation)

Switching on:

- Connect the vehicle to the external 230 V power supply and switch on the 230 V automatic circuit breaker.
- Set flip switch (Fig. 155,1) to on. The indicator lamp on the switch is illuminated. The water in the boiler is heated up to 65 °C.

Switching off:

- Set the flip switch (Fig. 155,1) to "O". The indicator lamp on the switch goes off.

Combined operation

The water is heated more quickly in the boiler if gas operation and 230 V electrical operation are switched on simultaneously.



- ▷ Further information can be obtained in the manufacturer's instruction manual.

Filling/emptying the boiler

The boiler can be supplied with water from the water tank.

Depending on the model, the vehicle is fitted with one or several boiler drain cocks. The drain cocks can have different designs (rocking lever or twist cap).

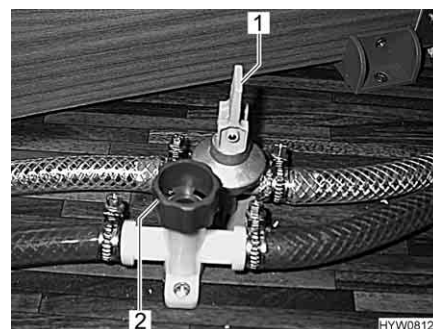

Fig. 156 Drain cocks

Filling the boiler with water:

- Close all boiler drain cocks. To do this, position the rocking lever (Fig. 156,1) horizontally or turn the cap (Fig. 156,2) in a clockwise direction.
- Set all the water taps to "Hot" and open them. The water pump is turned on. The warm water pipes are filled with water.

- Keep the taps open until the water flowing out of the taps has no bubbles in it. This is the only way to ensure that the boiler is full of water.
- Close all water taps.

Emptying the boiler:

- Set the rotary switch (Fig. 154,3) on the operating unit (Fig. 154) to "O" (Fig. 154,4) or the flip switch (Fig. 155,1) to "O".
- Turn knob (Fig. 154,1) anticlockwise until it can go no further.
- Open all boiler drain cocks. To do this, position the rocking lever (Fig. 156,1) vertically or turn the cap (Fig. 156,2) in an anticlockwise direction.
- Check whether the water has been drained completely from the boiler (approx. 12.5 litres).

9.2.10 Hot water source (partially special equipment)



- ▷ Do not fit a check valve in the cold water pipe between the hot water source and the water pump.
- ▷ Use a pressure reducer when connecting to a central water supply or with strong pumps. The hot water source is designed only for pressures of up to 1.2 bar. In addition, insert a safety/drainage valve in to the cold water pipe.



- ▷ Do not use the water from the hot water source as drinking water.



Fig. 157 Operating switch for hot water source

The hot water source can either be operated using the 230 V power supply (electrical mode of operation), with the hot air of the heater system or both types of energy. The hot water source heats approx. 5 l water to a temperature of approx. 65 °C.

The electrical mode of operation is activated using the operating switch (Fig. 157). The indicator lamp (Fig. 157,1) on the switch must illuminate.

During hot air operation, the water in the hot water source is heated up by the heater and the circulating air.

Depending on the model, the vehicle is fitted with one or two hot water source drain cocks.

- Switching on:*
- Connect the vehicle to the external 230 V power supply and switch on the 230 V automatic circuit breaker.
 - Switch on the operating switch (Fig. 157). Indicator lamp (Fig. 157,1) on the switch is illuminated. The water in the hot water source is heated up to 65 °C.

- Switching off:*
- Switch off the operating switch (Fig. 157). Indicator lamp (Fig. 157,1) on the switch goes off.

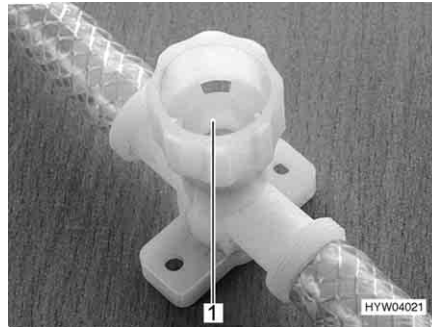

Fig. 158 Drain cock for hot water source

Filling the hot water source with water:

- Connect the vehicle to the external 230 V power supply and switch on the 230 V automatic circuit breaker.
- Switch off the operating switch (Fig. 157). Indicator lamp (Fig. 157,1) in the switch is not on.
- Close all drain cocks. To do this, close the caps (Fig. 158,1) by turning them in a clockwise direction.
- Set all the water taps to "Hot" and open them. The water pump is turned on. The warm water pipes are filled with water.
- Keep the taps open until the water flowing out of the taps has no bubbles in it. This is the only way to ensure that the hot water source is full of water.
- Close all water taps.

Emptying the hot water source:

- Switch off the 230 V power supply on the 230 V automatic circuit breaker.
- Open the stopper of the water tank.
- Open all water taps and set to the central position.
- Hang the shower handset up in the shower position.
- Hold the water pump up until the water pipes are completely empty.
- Open all drain cocks of the hot water source. To do this turn the caps (Fig. 158,1) in an anticlockwise direction.
- Check whether the water is completely drained from the hot water source.



- ▷ Further information can be obtained in the manufacturer's instruction manual.

9.3 Air conditioning unit (special equipment)

9.3.1 Dometic



- ▷ If the unit is operating, always open at least one ventilation flap.



- ▷ In the winter, vehicle heating can be supported but not replaced by the air conditioning unit.
- ▷ Also read the manufacturer's instruction manual.

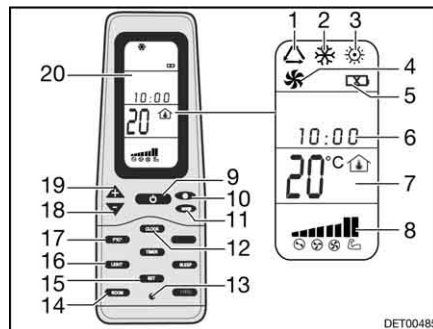

Fig. 159 Remote control

- 1 Symbol for automatic mode
- 2 Symbol for cold mode
- 3 Symbol for warm mode
- 4 Symbol for ventilation mode
- 5 Symbol for discharged batteries
- 6 Time
- 7 Temperature display
- 8 Fan speed display
- 9 ON/OFF button
- 10 Fan speed button
- 11 "MODE" button
- 12 "CLOCK" button
- 13 Reset key
- 14 Interior temperature display button "ROOM"
- 15 Store button "SET"
- 16 Light button "LIGHT" (optional)
- 17 Temperature unit change button "F/C"
- 18 Temperature decrease button "-"
- 19 Temperature increase button "+"
- 20 Display

To execute the individual switching commands, always point the remote control in the direction of the ceiling unit.

Operating modes

The air conditioning unit has the following operating modes:

- Automatic
- Ventilation, manual
- Cooling, manual
- Heating, manual

Switching on:

- Press the ON/OFF button (Fig. 159,9).
- Press the "Mode" button (Fig. 159,11) as often as required until the required mode (Fig. 159,1, 2, 3 or 4) is indicated on the display (Fig. 159,20).
- Use the "+" (Fig. 159,19) and "-" (Fig. 159,18) buttons to set the desired temperature.
- Use the fan speed button (Fig. 159,10) to select the desired fan level.

Switching off:

- Press the ON/OFF button (Fig. 159,9).



Fig. 160 Air conditioning unit (Dometic)

LED The LED (Fig. 160,4) on the ceiling unit (Fig. 160,1) displays the operating status of the air conditioning unit:

Status LED	Signification
Off	Air conditioning unit off
Orange	Air conditioning unit ready to operate
Green	Air conditioning unit in operation
Red (continuous)	No 230 V power connection
Red (flashes once intermittently)	Fault in the interior temperature gauge
Red (flashes twice intermittently)	Fault in the exterior temperature gauge

Air current The air current can be directed in different directions. The distribution of the air current toward the front or back is continuously adjustable.

Adjusting air current:

- Align the two deflectors (Fig. 160,3 and 5) in the desired position.
- Rotate knob (Fig. 160,2) on sliding regulator in an anticlockwise direction. The sliding regulator for air distribution is released.
- Slide the sliding regulator forwards or backwards to the desired position. The side on which the sliding regulator is located is closed.
- Turn the knob tight in the clockwise direction.

9.3.2 Telair



- ▷ Always wait at least 2 minutes between switching off and switching on again. Otherwise the compressor will be damaged.
- ▷ If the unit is operating, always open at least one ventilation flap.



- ▷ The air conditioning unit only runs if the vehicle is connected to a 230 V power supply.
- ▷ In the winter, vehicle heating can be supported but not replaced by the air conditioning unit.
- ▷ Following switch-on the air conditioning unit needs approx. 3 minutes until the compressor starts to run and cold air or hot air is output.
- ▷ Also read the manufacturer's instruction manual.

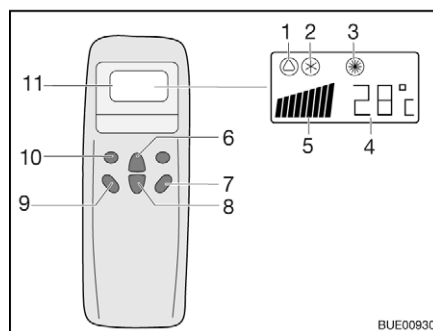

- 1 Symbol for automatic
- 2 Symbol for cooling
- 3 Symbol for heater
- 4 Temperature (set) display
- 5 Fan speed display
- 6 Temperature increase button
- 7 "ON/OFF" button
- 8 Temperature reduction button
- 9 Ventilation speed button
- 10 "Mode" button
- 11 Display

Fig. 161 Remote control

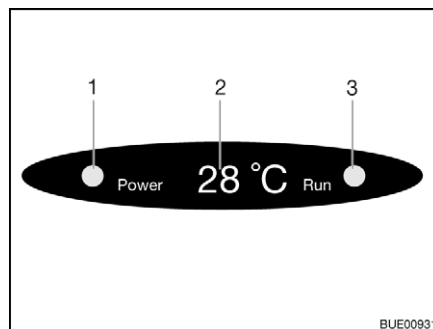

- 1 Mains connection indicator lamp
- 2 Temperature (current) display
- 3 Mode indicator lamp
Green: Cooling
Red: Heater

Fig. 162 Display on the diffuser

To execute the individual switching commands, always point the remote control in the direction of the receiver.

Operating modes

- Automatic
- Cooling
- Heater

Switching on:

- Press the "ON/OFF" button (Fig. 161,7).
- Press the "Mode" button (Fig. 161,10) as often as required until the required operating mode (Fig. 161,1, 2 or 3) is indicated on the display. The corresponding indicator lamp on the diffuser display (Fig. 162,3) lights up.
- Use the temperature increase button (Fig. 161,6) or temperature reduction button (Fig. 161,8) to set the required temperature.
- Use the ventilation speed button (Fig. 161,9) to select the required ventilation level.

Switching off:



- Press the "ON/OFF" button (Fig. 161,7).
- ▷ If the air conditioning unit has run in heating mode, the blower will run on for some minutes in order to dissipate the heat completely.

9.3.3 Truma



- ▷ The air conditioning unit only runs if the vehicle is connected to a 230 V power supply.
- ▷ The external 230 V power supply must be protected by a fuse of at least 3 A. It is otherwise not possible to operate the air conditioning unit properly.

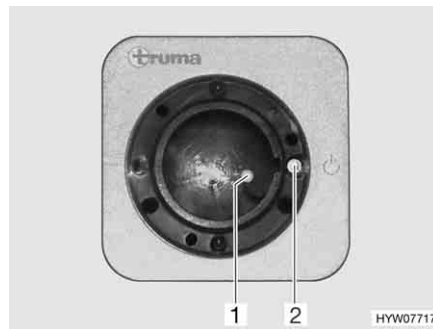

Fig. 163 Receiver

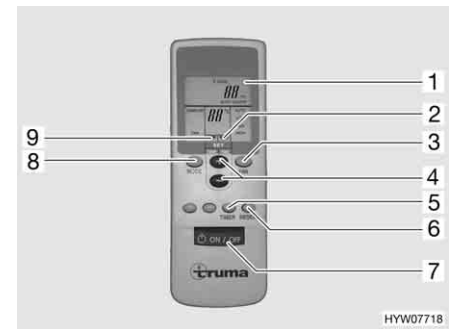

Fig. 164 Remote control

To execute the individual switching commands, always point the remote control in the direction of the receiver.

Switching on:

- Connect the vehicle to the 230 V power supply. The air conditioning unit is ready to operate.
- Switch on the remote control with the switch (Fig. 164,7). The green indicator lamp (Fig. 163,1) indicates cooling mode.
- Set the desired operating mode with the key (Fig. 164,8).
 - "FAN": Only ventilation without cooling.
 - "COMFORT": Cooling. The fan output and the room temperature can be set separately. The green indicator lamp in the receiver indicates the compressor is in operation and therefore cooling mode.
- Set the desired fan output and room temperature with the keys (Fig. 164,3 and 4) if necessary. The arrow (Fig. 164,9) indicates the selected setting mode.

If the temperature set on the remote control is reached, the green indicator lamp goes out, the compressor is switched off and the circulation fan continues to run.



- ▷ An additional key switch (Fig. 163,2) is on the receiver, which can be used to switch the air conditioning unit off or on without remote control. If the air conditioning unit is switched on by means of this key switch, the operating mode set last on the remote control is automatically selected.

Switching off:



- ▷ To switch off, press the key (Fig. 164,7) on the remote control again.
- ▷ Condensation accumulates on the vaporiser in cooling mode. To counteract any formation of germs, operate the air conditioning unit about 5 to 10 minutes in the "FAN" and "HIGH" positions to dry the vaporiser.

Timer The air conditioning unit can be switched on or off automatically from the current time up to 15 hours in advance with the integrated timer. Pre-programming up to a certain time is not possible.

- To program, switch on the air conditioning unit with the key (Fig. 164,7) on the remote control.
- Set the desired operating mode and room temperature with the keys (Fig. 164,8, 3 and 4).
- Use the key (Fig. 164,5) to select the desired function (Fig. 164,1):
 - "ON": Switching on
 - "OFF": Switching off
- Use the keys (Fig. 164,4) to select the desired switching time (1 to 15 hours). The arrow (Fig. 164,2) flashes and indicates the setting mode.
- If "ON" (switch on) was selected, the air conditioning unit must be switched off again with the remote control after the setting process. The indicator lamp in the receiver flashes and confirms the programming.
- The indicator lamp in the receiver flashes and confirms the programming if "OFF" (switch off) was selected. Do **not switch off** the air conditioning unit with the remote control.



- ▷ To go easy on the batteries in the remote control, the infrared transmitter can be covered by hand and the remote control then switched off after the "OFF" programming. In this way no signal is transferred to the receiver and the programming is retained.
- ▷ The key (Fig. 164,6) is used to send the settings of the remote control repeatedly to the receiver.
- ▷ Further information can be obtained in the manufacturer's instruction manual.

9.4 Cooker



- ▶ Never let gas escape unburned due to danger of explosion.
- ▶ Before using the cooker make sure that there is sufficient ventilation. Open windows or the skylight.
- ▶ Do not use gas cooker or gas oven for heating.
- ▶ Do not fit any curtains in the immediate proximity of the cooker. Fire hazard!
- ▶ Always protect your hands with cooking gloves or potholders when handling hot pots, pans and similar items. There is a risk of injury.

9.4.1 Gas cooker



- ▶ During activation and operation of the gas cooker, no flammable objects or highly inflammable objects such as dishcloths, napkins etc. must be near the gas cooker. Fire hazard!
- ▶ The process of ignition must be visible from above and must not be covered by cooking pans placed on the cooker.
- ▶ If there is a flame protection, always put it up when using the gas cooker.
- ▶ The gas cooker lid is held closed by a spring. When closing there is danger of getting injured!



- ▷ Do not place hot objects such as cooking pans on the sink cover. The plastic can become deformed.
- ▷ Do not use the glass gas cooker lid as a hob.
- ▷ Do not close the gas cooker lid while the gas cooker is in operation.
- ▷ Do not apply pressure on the gas cooker lid when it is closed.
- ▷ Do not place hot cooking pans on the gas cooker lid.
- ▷ Keep the gas cooker lid open after cooking until the burners are cool. Otherwise the glass plate could shatter.



- ▷ Only use pots and pans whose diameter is appropriate for the gas cooker burners.
- ▷ When the flame goes out, the thermocouple automatically cuts the gas supply.
- ▷ Further information can be obtained in the device manufacturer's instruction manual.

The kitchen unit is fitted with a three-burner gas cooker.

Depending on the model, the gas cooker may be lit manually or with automatic ignition.

Manual ignition

The gas cooker must be lit manually.



Fig. 165 Operating controls for gas cooker

Switching on:

- Open the regulator tap on the gas bottle and the gas isolator tap "Cooker".
- Open the gas cooker lid.
- Turn the control knob (Fig. 165, 1) on the burner you wish to use to the ignition position (large flame).
- Press the control knob down and hold it.
- Light the burner with a gas lighter, a match or other suitable means of lighting.
- Once the flame is burning, the control knob must be held down for 10 to 15 seconds, until the thermocouple automatically keeps the gas supply open.
- Release the control knob and turn to the desired setting.
- If ignition is unsuccessful, repeat the entire procedure.

Switching off:

- Turn the control knob to the 0-position. The flame fades.
- Close the gas isolator tap "Cooker" and the regulator tap on the gas bottle.

Automatic ignition The gas cooker is equipped with electronic ignition.

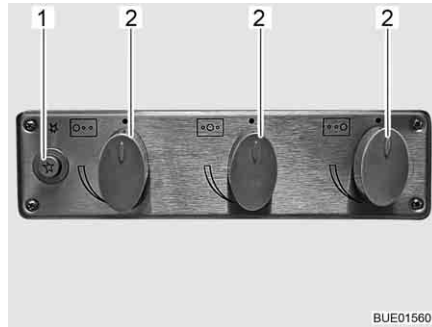

Fig. 166 Operating controls for gas cooker

- Switching on:**
- Open the regulator tap on the gas bottle and the gas isolator tap "Cooker".
 - Open the gas cooker lid.
 - Depending on the model, fold out and lock the flame protection.
 - Turn the control knob (Fig. 166,2) on the burner you wish to use to the ignition position (large flame).
 - Press the push button (Fig. 166,1).
The automatic ignition produces ignition sparks. A clicking noise can be heard.
 - Once the flame is burning, the control knob must be held down for 10 to 15 seconds, until the thermocouple automatically keeps the gas supply open.
 - Release the control knob and turn to the desired setting.
- Switching off:**
- Turn the control knob to the 0-position. The flame fades.
 - Close the gas isolator tap "Cooker" and the regulator tap on the gas bottle.

9.4.2 Gas oven (Dometic) (special equipment)



- ▶ Keep the ventilation openings on the gas oven open at all times.
- ▶ There must be no flammable or highly inflammable objects such as dishcloths, clothes, etc. near the gas oven when it is being lit or during operation. Fire hazard!
- ▶ If ignition has not taken place, repeat the entire procedure. If necessary, check if there is gas and/or current in the gas oven.
- ▶ If the gas oven still does not work, close the gas isolator tap and notify your service centre.
- ▶ If the burner flame is accidentally extinguished, turn the control knob to "0" and leave the burner off for at least 1 minute. Then ignite it again.
- ▶ Parts of the gas oven become very hot during operation. Never touch hot parts with bare hands.
- ▶ Place the meals, wire rack and drip pan into the gas oven so that they do not come into contact with the flame.
- ▶ Only ignite the oven and grill when the oven door is open.
- ▶ Always leave the oven door half open when grilling.
- ▶ Do not use the grill for longer than 25 minutes.



- ▷ There are two different versions of the gas oven, depending on the model. Although their appearance is not identical, operation is the same for both.
- ▷ Depending on the model the gas oven may come equipped with a grill.
- ▷ Before using the gas oven for the first time run it for 30 minutes at maximum temperature without any contents.
- ▷ When the flame goes out, the thermocouple automatically cuts the gas supply.
- ▷ A safety switch prevents ignition when the oven door is closed.
- ▷ If the ignition procedure fails repeatedly, turn the control knob to "0". Wait at least 1 minute and then ignite the gas oven manually. If necessary, check if there is gas and/or current in the gas oven. If the gas oven still does not work, close the gas isolator tap and notify your service centre.
- ▷ Further information can be obtained in the manufacturer's instruction manual.

The gas oven is equipped with electronic ignition.







Fig. 167 Gas oven (Dometic TecTower)



Fig. 168 Gas oven (Dometic)

The meaning of the symbols on the control knobs (Fig. 167,1 and Fig. 168,1) of the two gas ovens is identical:

-  and  mean oven
-  and  mean grill.

Switching the oven on:

- Open the regulator tap on the gas bottle and the gas isolator tap "Oven".
- Open oven door completely. The safety switch then releases the ignition.
- Press and hold control knob (Fig. 167,1 and Fig. 168,1) and turn it anti-clockwise to the required setting. Keep control knob pressed for a further 5-10 seconds. Ignition will take place automatically.
- Release control knob.
- Close oven door.

Switching the grill on:

- Open the regulator tap on the gas bottle and the gas isolator tap "Oven".
- Open the oven door to at least the first locking position (approx. 45°).
- Press and hold control knob and turn it clockwise to the grill symbol. Keep control knob pressed for a further 5-10 seconds. Ignition will take place automatically.
- Release control knob.
- ▷ Do not close the oven door when grilling.



- Switching off:*
- Turn the control knob to "0". The flame fades.
 - Close the gas isolator tap "Oven" and the regulator tap on the gas bottle.

9.4.3 Microwave oven (special equipment)



- ▶ Only qualified personnel may repair the microwave oven. Improper repairs can cause major risks to the user.
- ▶ The protection device against the escape of microwave energy should never be removed.
- ▶ Use the microwave oven only if it has been properly installed.
- ▶ Only use the microwave oven when the door seal is free of damage.
- ▶ Never leave the microwave oven unattended when it is in operation.
- ▶ If there is smoke, keep the microwave oven closed, switch it off and interrupt the power supply.



- ▷ Operate the microwave oven only with the rotary plate and the rotary cross in place.
- ▷ Use only crockery suitable for microwave use.
- ▷ Only operate the microwave with appropriate contents and never run it empty.



- ▷ For cooking times under 2 minutes: First twist the cooking time control knob past "2" and then twist it back to the desired cooking time.
- ▷ Further information can be obtained in the manufacturer's instruction manual.



Fig. 169 Operating controls for microwave oven

- Switching on:*
- Press the key (Fig. 169,3) to open the door and place food into the cooking area.
 - Close the door. A clicking noise can be heard when it engages.
 - Select the output on the control knob (Fig. 169,1).
 - Select the cooking time with the control knob (Fig. 169,2). Cooking begins.
- The end of the cooking process is signaled by a signal tone. The microwave oven will switch off automatically.

- Switching off:*
- Press the key (Fig. 169,3) to open the door and take out the food.

9.4.4 Extractor hood (special equipment)

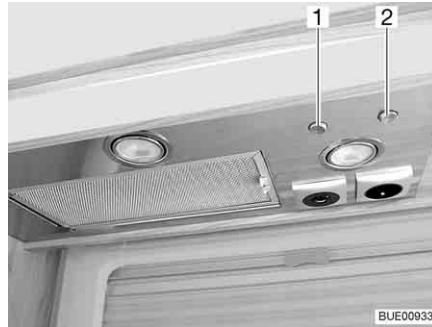

Fig. 170 Extractor hood

The cooking area is equipped with an extractor hood. The powerful fan blows the cooking steam directly outside. To switch on the extractor hood, press the right flip switch (Fig. 170,2).

Use the left flip switch (Fig. 170,1) to switch on the two lights in the extractor hood.

9.5 Refrigerator

During the journey, only operate the refrigerator via the 12 V power supply. At high ambient temperatures the refrigerator is unable to reach its full cooling power.



- ▷ The cooling power of the refrigerator depends on the vehicle setup. The cooling power can decrease if the vehicle is inclined by 5° or more. Therefore, always park the vehicle on level ground.
- ▷ Absorption refrigerators operate at normal room temperature (approx. 21 °C) within the specified temperature range. At significantly higher ambient temperatures (> 30 °C), the cooling power is reduced. This is because the "evaporating temperature" of the refrigerant is lower in absorption refrigerators than it is in compressor refrigerators.

9.5.1 Refrigerator ventilation grill

At high external temperatures, the full cooling power of the cooling unit is only guaranteed if the refrigerator is ventilated sufficiently. In order to achieve a better ventilation the refrigerator ventilation grill can be removed.



- ▷ When leaving the vehicle, always mount the refrigerator ventilation grill. Otherwise water can enter during rain.

Dometic

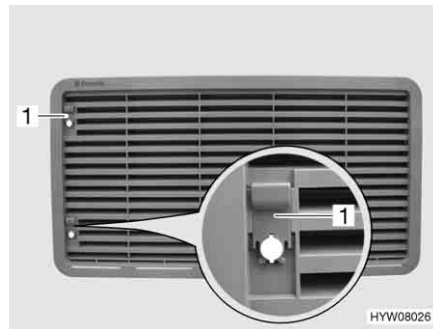

Fig. 171 Refrigerator ventilation grill
(with sliding trap)

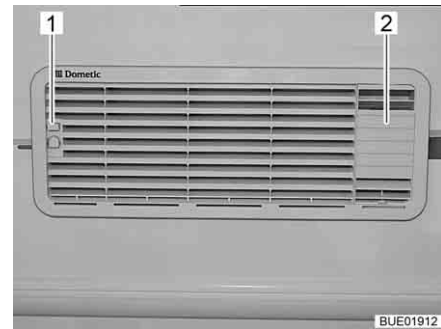

Fig. 172 Refrigerator ventilation grill
(with insert for exhaust emission)

- Removing:*
- Depending on the version, push up the sliding trap (Fig. 171,1 or Fig. 172,1).
 - Remove refrigerator ventilation grill.
 - Release the insert for exhaust emission (Fig. 172,2) at the top and remove.



Fig. 173 Refrigerator ventilation grill
(with screw)

- Removing:*
- Turn screw (Fig. 173,1) one quarter turn using a coin.
 - Remove refrigerator ventilation grill.

Thetford

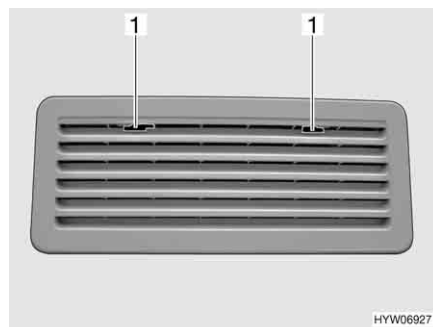

Fig. 174 Refrigerator ventilation grill
(Thetford)

- Removing:*
- Move the locking device (Fig. 174,1) to the middle.
 - Remove refrigerator ventilation grill.

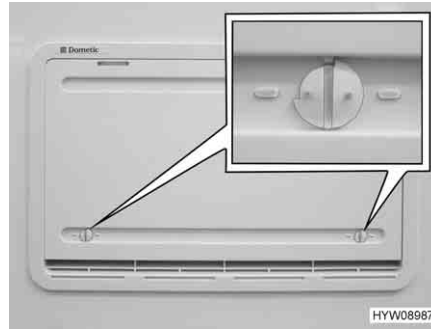

Fig. 175 Winter cover

Winter cover

If the refrigerator is to be operated at low external temperatures, the manufacturer recommends the use of a winter cover (Fig. 175) for the refrigerator ventilation grills.

The table below shows the temperature ranges in which the winter cover or the insulated winter cover may be used.

Temperature	Cover
Below 10 °C	Winter cover (for refrigerators with capacity below 130 litres: fit only on the lower ventilation grill)
Below -5 °C	Insulated winter cover (fit only on the lower ventilation grill)



- ▷ If the temperatures are higher than the indicated values, it is absolutely necessary to remove the winter cover. Otherwise the vehicle could be damaged.

Mounting:

- Open both locks (Fig. 175) (groove in horizontal position).
- Put winter cover in front of the ventilation grill.
- Lock the locks with a small coin (groove in vertical position).

Removing:

- Open both locks (Fig. 175) (groove in horizontal position).
- Remove winter cover from ventilation grill.
- ▷ The winter cover may remain mounted during the journey.



9.5.2 Operation (Dometic with manual power selection MES)

Operating modes

The refrigerator has 3 operating modes:

- Gas operation
- 230 V AC
- 12 V DC

The operating mode is set with the operating controls on the refrigerator panel.



- ▷ Select only one energy source.
- ▷ The refrigerator always requires a 12 V control voltage, regardless of which type of energy it is using. The control voltage is present as soon as the transformer/rectifier is switched on. Therefore the closed circuit current always flows even if the refrigerator is switched off. Always switch off the transformer/rectifier for a temporary lay-up.

Gas operation



▶ Never let gas escape unburned due to danger of explosion.

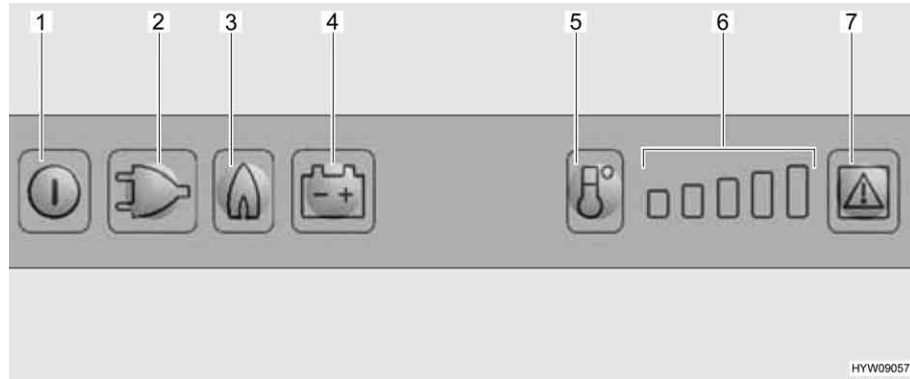

Fig. 176 Operating controls for the refrigerator

- 1 On/Off button
- 2 Illuminated button for "230 V" mode
- 3 Illuminated button for "Gas" mode
- 4 Illuminated button for "12 V" mode
- 5 Temperature range selection button
- 6 Temperature range display
- 7 Illuminated "Fault" button

Switching on:

- Open the regulator tap on the gas bottle and the gas isolator tap "Refrigerator".
- Press and hold the On/Off button (Fig. 176,1) for about 2 seconds. The refrigerator switches itself on. The button of the operating mode chosen most recently lights up.
- If necessary, press the button for the operating mode "Gas" (Fig. 176,3). The button lights up. Gas supply is open. Ignition will take place automatically. A ticking sound can be heard until ignition has been completed successfully.
- Use the temperature range selection button (Fig. 176,5) to set the refrigerating temperature.

Switching off:

- Press and hold the On/Off button for about 2 seconds. Refrigerator is switched off.
- Close the gas isolator tap "Refrigerator" and the regulator tap on the gas bottle.

Electrical operation



▷ Close the gas isolator tap "Refrigerator" when the refrigerator is operated electrically.

The refrigerator can be operated with the following voltages:

- 230 V AC
- 12 V DC

Switching the 230 V operation on:

- Press and hold the On/Off button (Fig. 176,1) for about 2 seconds. The refrigerator switches itself on. The button of the operating mode chosen most recently lights up.
- If necessary, press the button for the operating mode "230 V" (Fig. 176,2). The button lights up.
- Use the temperature range selection button (Fig. 176,5) to set the refrigerating temperature.

Switching the 230 V operation off:

- Press and hold the On/Off button for about 2 seconds. Refrigerator is switched off.

Switching the 12 V operation on:

- Press and hold the On/Off button (Fig. 176,1) for about 2 seconds. The refrigerator switches itself on. The button of the operating mode chosen most recently lights up.
- If necessary, press the button for the operating mode "12 V" (Fig. 176,4). The button lights up.
- Use the temperature range selection button (Fig. 176,5) to set the refrigerating temperature.

Switching the 12 V operation off:

- Press and hold the On/Off button for about 2 seconds. Refrigerator is switched off.

When operated with 12 V, the refrigerator draws power only from the starter battery of the vehicle. The starter battery only supplies the refrigerator with 12 V when the vehicle engine is running. When the vehicle engine is not running, the refrigerator is cut off from the power supply in the living area. For this reason, change over to gas operation during prolonged driving breaks.



- ▷ Further information can be obtained from the separate instruction manual "Refrigerator".

9.5.3 Operation (Dometic RMD with automatic power selection)

Operating modes

The refrigerator is equipped with automatic power selection (AES). If the selector switch is set to "AES", the AES automatically selects the optimum energy source and regulates the refrigerator operation. Manual intervention to select the type of power is possible but not required.

The AES selects from the following types of power:

- 12 V solar (special equipment)
- 230 V AC
- Gas
- 12 V DC

Choosing the available energy source highest on the list.



- ▷ The refrigerator always requires a 12 V control voltage, regardless of which type of energy it is using. The control voltage is drawn from the living room area battery. Therefore the closed circuit current always flows even if the refrigerator is switched off. Always disconnect the refrigerator from the battery for a temporary lay-up.

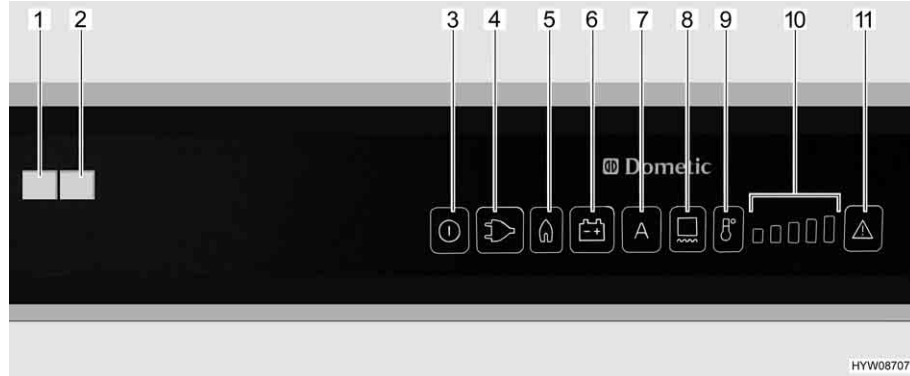

Fig. 177 Operating controls for the refrigerator (Dometic RMD)

- 1 "Fault" indicator lamp (visible when the refrigerator door is closed)
- 2 "Operating" indicator lamp (visible when the refrigerator door is closed)
- 3 On/Off button
- 4 Illuminated button for "230 V" mode
- 5 Illuminated button for "Gas" mode
- 6 Illuminated button for "12 V" mode
- 7 Illuminated button for "AES" mode (automatic power selection)
- 8 Illuminated button for frame heater
- 9 Temperature range selection button
- 10 Temperature range display
- 11 Illuminated button for "Fault"/"Reset" in gas mode

230 V operation

If the "AES" operating mode is set and the 230 V supply is connected, the AES selects this energy source first.

12 V operation

If the "AES" operating mode is set, the AES only selects 12 V operation if the vehicle engine is running (alternator signal D+).

Gas operation



- ▶ Never let gas escape unburned due to danger of explosion.



- ▷ If LPG is used, the gas burner must be cleaned more frequently.
- ▷ Open the regulator tap on the gas bottle and the gas isolator tap "Refrigerator".

If the "AES" operating mode is set, the 230 V supply is **not** connected and the vehicle engine is **switched off**, the AES selects the gas supply. When selecting gas operation the ignition fuse is opened automatically so gas can get into the burner. At the same time the electronic ignition is activated. If the gas flame is extinguished, e.g. by blast of wind, the ignition is activated immediately and re-ignites the gas. If there is a fault in gas operation, the illuminated buttons "Gas" (Fig. 177,5) and "Fault" (Fig. 177,11) flash. The "Fault" indicator lamp (Fig. 177,1) lights up and an alarm sounds for 20 seconds.

Change-over between energy sources

- ▶ Open flames are prohibited at petrol stations. If the stop takes longer than 15 minutes, the refrigerator has to be turned off at the energy selector switch.

When changing over from 230 V or 12 V to gas, delay times are built into the AES. For example, when changing over from 12 V operation to gas operation, a 15 minute delay is built in the AES. This prevents a change-over to gas operation when the vehicle is stopped briefly and the engine is switched off (e.g. stop to fill tank).

Refrigerating temperature control

When turned on the first time the refrigerator automatically selects the middle thermostat position. This position can be adjusted manually using the temperature range selection button (Fig. 177,9). The indicator lamps (Fig. 177,10) show the selected thermostat position. The refrigerating temperature for all three types of energy is set with the temperature range selection button. It takes a few hours till the refrigerator reaches its normal operating temperature. When changing over the operating mode the thermostat setting will be maintained. The refrigerating temperature is retained regardless of the type of energy being used.

Frame heater (FH)

- ▷ When the frame heater is turned on, it uses about 4 Watts, including in gas operation. To avoid running down the living area battery, in gas mode refrain from running the frame heater in continuous operation or turn the frame heater off entirely.

The following options are available for operating times of the frame heater:

- 2 hours
- 5 hours
- Continuous operation (switched on for 30 minutes, then for 5 minutes on and 5 minutes off in alternating intervals)

Setting operating time:

- Switch on the frame heater for a 2 hour period: Push button (Fig. 177,8) once. One bar is lit up on the temperature range display (Fig. 177,10).
- Switch on the frame heater for a 5 hour period: Push button (Fig. 177,8) twice. Two bars are lit up on the temperature range display (Fig. 177,10).
- Setting frame heater for continuous operation: Push button (Fig. 177,8) three times. Three bars are lit up on the temperature range display (Fig. 177,10).

The temperature range display (Fig. 177,10) shows the operating time of the frame heater for several seconds.

High external temperatures and high humidity can cause drops of water to form on the metal frame of the freezer compartment. This is why the refrigerator is equipped with a frame heater for the freezer compartment. If the temperature and humidity are high, switch on the frame heater by pressing the button (Fig. 177,8). This prevents corrosion. If the frame heater is switched on, the illuminated button (Fig. 177,8) is lit.

Manual operation

- Switching on:*
- Open the regulator tap on the gas bottle and the gas isolator tap "Refrigerator".
 - Press and hold the On/Off button (Fig. 177,3) for about 2 seconds. The refrigerator switches on and the previously set type of energy or "AES" is displayed.
 - Press the button for the desired energy type or the automatic "AES" mode.
 - Use the temperature range selection button (Fig. 177,9) to set the refrigerating temperature. The indicator lamps (Fig. 177,10) show the selected thermostat position.

When operated with 12 V, the refrigerator draws power only from the living area battery.



- ▷ If the refrigerator is manually set to "12 V", it will constantly consume current. Therefore, switch over to gas operation when the vehicle engine is **not** running, and the vehicle is **not** connected to the 230 V power supply.

- Switching off:*
- Press and hold the On/Off button (Fig. 177,3) for about 2 seconds. The refrigerator switches off and no displays are lit.
 - Close the gas isolator tap "Refrigerator" and the regulator tap on the gas bottle.

Additional functions

In automatic mode, "AES" and the type of power currently in use are displayed. The brightness of the display is reduced after a few seconds if no other buttons are pressed. When the door is opened, the interior light goes out after 2 minutes. If the door is open for longer than 2 minutes, the operating indicator lamp flashes and a warning signal sounds.



- ▷ Further information can be obtained from the separate instruction manual "Refrigerator".

9.5.4 Operation (Thetford with manual power selection)



- ▷ The refrigerator starts when it is switched on with the setting selected last.
- ▷ Flashing lamps on the operating unit indicate a fault (see separate instruction manual "Refrigerator").

Operating modes

The refrigerator has 3 operating modes:

- Gas operation
- 230 V operation
- 12 V operation

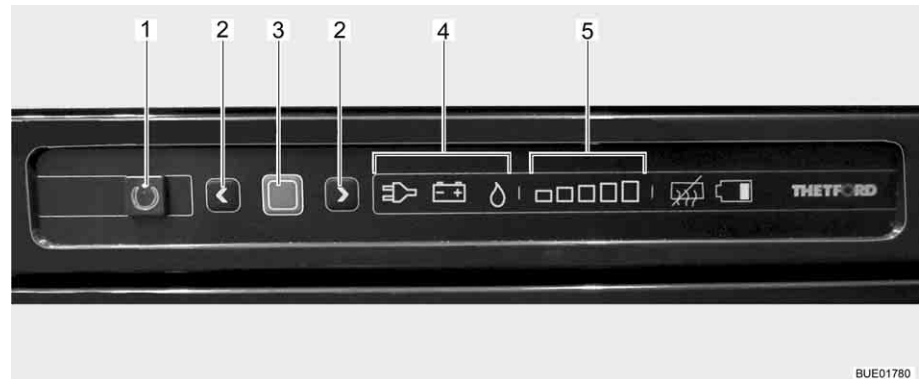

Fig. 178 Operating controls for the refrigerator

- 1 On/Off button
- 2 Arrow keys
- 3 Confirmation button
- 4 Indicator for operating mode (230 V operation/12 V operation/gas operation)
- 5 Indicator for cooling level (lowest - highest cooling level)

The current operating mode is indicated by an illuminated symbol (Fig. 178,4) on the operating unit.



- ▷ The refrigerator always requires a 12 V control voltage, regardless of which type of energy it is using. The control voltage is present as soon as the transformer/rectifier is switched on. Therefore the closed circuit current always flows even if the refrigerator is switched off. Always switch off the transformer/rectifier for a temporary lay-up.



- ▷ We recommend that the refrigerator be operated in 12 V operation when the vehicle is in motion.
When the vehicle is stationary, we advise you to operate the refrigerator in 230 V operation, assuming a 230 V connection is available.
In all other cases, the refrigerator can be operated in gas operation.

Refrigerating temperature control

When turned on the refrigerator automatically selects the thermostat position selected last. This position can be adjusted manually by using the arrow keys (Fig. 178,2). The illuminated bars of the cooling level indicator (Fig. 178,5) show the selected thermostat position. The refrigerating temperature for the three types of energy is set with the arrow keys. It takes a few hours till the refrigerator reaches its normal operating temperature. When changing over the operating mode the thermostat setting will be maintained. The refrigerating temperature is retained regardless of the type of energy being used.

Gas operation



- ▶ Never let gas escape unburned due to danger of explosion.

Switching on:

- Open the regulator tap on the gas bottle and the gas isolator tap "Refrigerator".
- Press and hold the On/Off button (Fig. 178,1) for 1 second. Button (Fig. 178,1) lights up green. To save energy, after approximately 10 seconds the display is dimmed.
- Press confirmation button (Fig. 178,3). The current setting of the operating is displayed.
- If the operating mode gas is not set: To change the setting, press and hold the confirmation button (Fig. 178,3) for approximately 2 seconds.
- Using the arrow keys (Fig. 178,2) select the operating mode gas. Gas supply is open. Ignition will take place automatically. A ticking sound can be heard until ignition has been completed successfully.
- Press and hold the confirmation button (Fig. 178,3) for about 2 seconds.
- Press confirmation button (Fig. 178,3) again. The current cooling level is shown by the illuminated bars (Fig. 178,5).
- To change the setting, press the arrow keys (Fig. 178,2) until the desired setting is displayed.

Switching off:

- Press and hold the On/Off button (Fig. 178,1) for about 2 seconds. All lights go out. Refrigerator is switched off.
- Close the gas isolator tap "Refrigerator" and the regulator tap on the gas bottle.

Electrical operation



- ▷ Close the gas isolator tap "Refrigerator" when the refrigerator is operated electrically.

The refrigerator can be operated with the following voltages:

- 230 V AC
- 12 V DC

Switching the 230 V operation on:

- Press and hold the On/Off button (Fig. 178,1) for 1 second. Button (Fig. 178,1) lights up green. To save energy, after approximately 10 seconds the display is dimmed.
- Press confirmation button (Fig. 178,3). The current setting of the operating is displayed.
- If 230 V operating mode is not set: To change the setting, press and hold the confirmation button (Fig. 178,3) for approximately 2 seconds.
- Using the arrow keys (Fig. 178,2) select the 230 V operating mode.
- Press and hold the confirmation button (Fig. 178,3) for about 2 seconds.
- Press confirmation button (Fig. 178,3) again. The current cooling level is shown by the illuminated bars (Fig. 178,5).
- To change the setting, press the arrow keys (Fig. 178,2) until the desired setting is displayed.

Switching the 230 V operation off:

- Press and hold the On/Off button (Fig. 178,1) for about 2 seconds. All lights go out. Refrigerator is switched off.

Switching the 12 V operation on:

- Press and hold the On/Off button (Fig. 178,1) for 1 second. Button (Fig. 178,1) lights up green. To save energy, after approximately 10 seconds the display is dimmed.
- Press confirmation button (Fig. 178,3). The current setting of the operating is displayed.
- If the 12 V operating mode is not set: To change the setting, press and hold the confirmation button (Fig. 178,3) for approximately 2 seconds.
- Using the arrow keys (Fig. 178,2) select the 12 V operating mode.
- Press and hold the confirmation button (Fig. 178,3) for about 2 seconds.
- Press confirmation button (Fig. 178,3) again. The current cooling level is shown by the illuminated bars (Fig. 178,5).
- To change the setting, press the arrow keys (Fig. 178,2) until the desired setting is displayed.

Switching the 12 V operation off:

- Press and hold the On/Off button (Fig. 178,1) for about 2 seconds. All lights go out. Refrigerator is switched off.

When operated with 12 V, the refrigerator draws power only from the starter battery of the vehicle. The starter battery only supplies the refrigerator with 12 V when the vehicle engine is running. If the vehicle engine is switched off, the cooling no longer operates. However the refrigerator continues to operate via the transformer/rectifier with a control voltage from the living room area battery. For this reason, change over to gas operation during prolonged driving breaks.



- ▷ Further information can be obtained from the separate instruction manual "Refrigerator".

9.5.5 Operation (Thetford with automatic power selection)

Operating modes

The refrigerator is equipped with an automatic system to select the type of power. In operating mode automatic "A", the system automatically selects the optimum energy source. Manual intervention to select the type of power is possible but not required.

The system selects from the following energy sources in the "Automatic" operating mode:

- 230 V AC
- 12 V DC
- Gas

Choosing the available energy source highest on the list.

The previously set operating mode is preselected when the refrigerator is switched on.



- ▷ The refrigerator always requires a 12 V control voltage, regardless of which type of energy it is using. The control voltage is present as soon as the transformer/rectifier is switched on. Therefore the closed circuit current always flows even if the refrigerator is switched off. Always switch off the transformer/rectifier for a temporary lay-up.

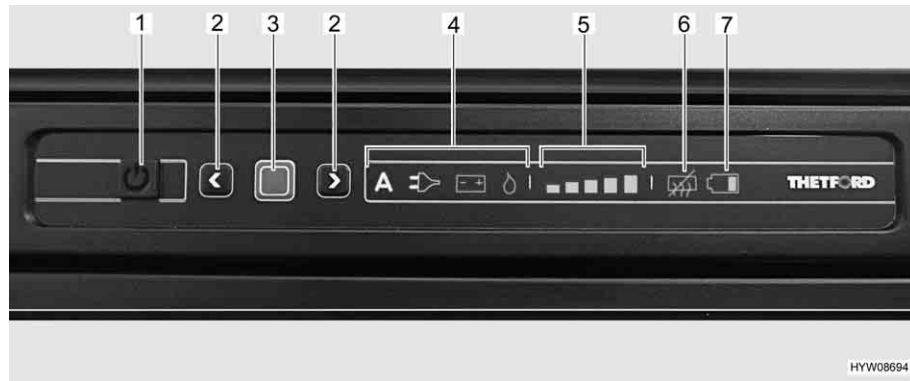

Fig. 179 Operating controls for the refrigerator

- 1 On/Off button
- 2 Arrow keys
- 3 Confirmation button
- 4 Display operating mode
- 5 Display cooling levels
- 6 Display "anti-condensation off"
- 7 Display "Battery flat" (not active)

If there is a fault in the energy source that is set, the system switches to the next available energy source. If no other energy source is available, the operating indicator flashes and an error code appears on the display.

230 V operation If the 230 V power supply is connected, this energy source is selected as the first priority by the system.

12 V operation 12 V operation is only selected by the system if the vehicle's engine is running and the alternator supplies sufficient 12 V operating voltage.

Gas operation



- ▶ Never let gas escape unburned due to danger of explosion.



- ▷ Open the regulator tap on the gas bottle and the gas isolator tap "Refrigerator".

If the 230 V power supply is disconnected and the vehicle's engine is not running the system selects the gas supply. When selecting gas operation the ignition fuse is opened automatically so gas can get into the burner. At the same time the electronic ignition is activated. If the gas flame is extinguished, e.g. by blast of wind, the ignition is activated immediately and re-ignites the gas.

Change-over between energy sources

- ▶ Open flames are prohibited at petrol stations. If the stop takes longer than 15 minutes, the refrigerator has to be turned off at the On/Off button.

When changing over between the different energy sources there are forced delays built in the system. This means, that after a change-over to a new energy source the refrigerator can not be operated immediately. When changing over from 12 V operation to gas operation, a 15-minute delay is built in the system. This prevents a change-over to gas operation when the vehicle is stopped briefly and the engine is switched off (e.g. stop to fill tank).

Refrigerating temperature control

When it is switched on, the refrigerator automatically selects the thermostat setting selected last. This position can be adjusted manually by using the arrow keys (Fig. 179,2). The illuminated bars of the cooling level indicator (Fig. 179,5) show the selected thermostat position.

The height of the bar indicates the cooling power selected:

- Small bar = low cooling setting
- Tall bar = high cooling setting

The refrigerating temperature for the three types of energy is set with the arrow keys (Fig. 179,2). It takes a few hours till the refrigerator reaches the set operating temperature. When changing over the operating mode the thermostat setting will be maintained. The refrigerating temperature is retained regardless of the type of energy being used.

Operation
Switching on:

- Press and hold the On/Off button (Fig. 179,1) for 1 second. Button lights up green. The indicators stay on for 10 seconds and are then dimmed to save energy.
- Press confirmation button (Fig. 179,3). The current setting of the operating is displayed.

Selecting operating mode:

- Press and hold the confirmation button (Fig. 179,3) for about 2 seconds. The operating mode symbols (Fig. 179,4) flash.
- Use the arrow keys (Fig. 179,2) to select the desired operating mode.
- Press the confirmation button to confirm the selection.

Setting the refrigeration temperature:

- Press and hold the confirmation button (Fig. 179,3) for about 2 seconds. The operating mode symbols flash.
- Press confirmation button again. The display of cooling levels (Fig. 179,5) flashes.
- Use the arrow keys (Fig. 179,2) to set the desired cooling power.
- Press the confirmation button to confirm the selection.

Switching off:

- Press and hold the On/Off button (Fig. 179,1) for about 2 seconds. All lights go out.
- Close the gas isolator tap "Refrigerator" and the regulator tap on the gas bottle.

Anti-condensation



- ▷ The anti-condensation function prevents the operating panel from misting up and is switched on as standard. Only switch off this function if energy reserves are low.

Switching off:

- Press both arrow keys (Fig. 179,2) simultaneously for approximately 2 seconds. The "anti-condensation off" symbol (Fig. 179,6) lights up.

Switching on:

- Press both arrow keys (Fig. 179,2) simultaneously for approximately 2 seconds. The "anti-condensation off" symbol (Fig. 179,6) goes out.



- ▷ Further information can be obtained in the manufacturer's instruction manual.

9.5.6 Refrigerator door locking mechanism

With some models, the refrigerator has a separate freezer compartment. The specifications in this section correspondingly also apply to the door of the freezer compartment.



- ▷ During the journey the refrigerator door must always be closed and locked in the closed position.



- ▷ Lock the refrigerator door in ventilation position when the refrigerator is switched off. This prevents mould forming.

There are two positions for locking the refrigerator door in place:

- Closed refrigerator door during travel and when the refrigerator is in operation
- Slightly opened refrigerator door as a ventilation position when the refrigerator is switched off

Dometic 8 series



Fig. 180 Release button of the refrigerator door (Dometic 8 series)

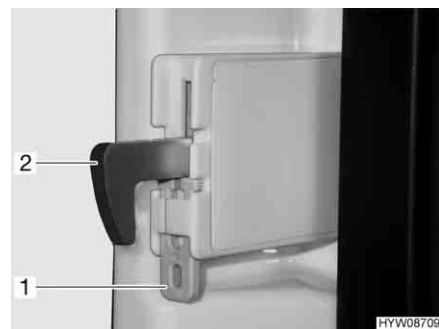

Fig. 181 Lock hook fixture

Opening: ■ Press the release button (Fig. 180,1) and open the refrigerator door.

Closing: ■ Close the refrigerator door. The lock hook engages audibly.

When the vehicle has been positioned, the lock hook can be fixed. The refrigerator door can now be opened without having to press the release button.

Fixing the lock hook:

- Press the fixture (Fig. 181,1) upwards. The lock hook (Fig. 181,2) is pressed upwards and has no function.

Unlocking the lock hook:

- Push the lock hook (Fig. 181,2) down. The lock hook functions again.

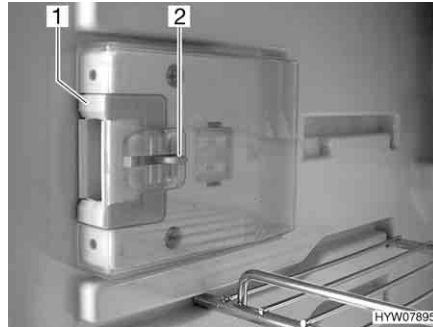

Fig. 182 Locking device in normal position

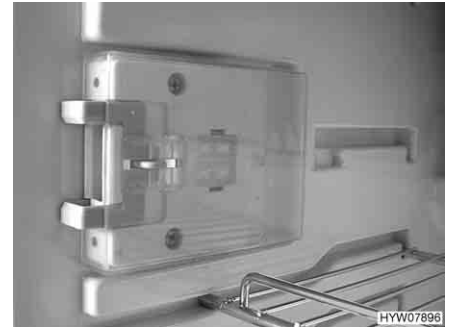

Fig. 183 Locking device in ventilation position

Locking in the ventilation position:

- Open the refrigerator door.
- Press down the unlocking device (Fig. 182,2).
- Push locking device (Fig. 182,1) forwards (Fig. 183).

If the refrigerator door is closed now, a gap will remain between the refrigerator door and the refrigerator.

Thetford

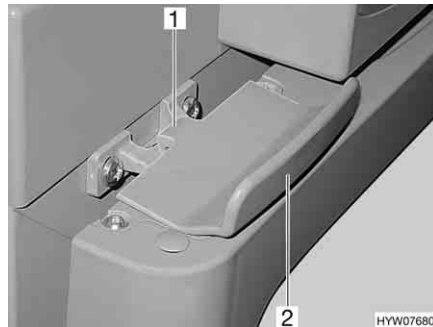

Fig. 184 Lock of refrigerator door, closed (Thetford)

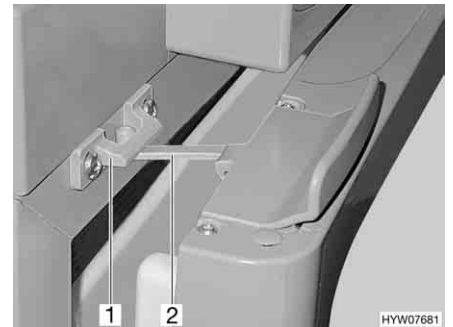

Fig. 185 Refrigerator door in ventilation position (Thetford)

Opening:

- Open the refrigerator door at the handle (Fig. 184,2). The lock (Fig. 184,1) is released automatically.

Closing:

- Fully close the refrigerator door. Ensure that the lock is engaged.

Locking in the ventilation position:

- Slightly open refrigerator door.
- Open the lock (Fig. 185,2) and snap it into the locking catch (Fig. 185,1). The refrigerator door will then stay slightly open.

Thetford (alternative) The refrigerator is opened and closed with the handle on the door.

Ventilation position The refrigerator door may be locked in ventilation position with a swivelling bracket.



Fig. 186 Locking device in normal position



Fig. 187 Locking device in ventilation position

Locking in the ventilation position:

- Open the refrigerator door.
- Swing the bracket (Fig. 186,1) to the front (Fig. 187).

If the refrigerator door is closed now, a gap will remain between the refrigerator door and the refrigerator.

Chapter overview

This chapter contains instructions regarding the sanitary fittings of the caravan.

The instructions address the following topics:

- complete water system
- water tank
- waste water installation
- heater for the waste water pipes
- toilet compartment
- toilet

10.1 Water supply, general



- ▶ Fill water tank from supply systems that have been verified to provide drinking water quality.
- ▶ Only use such hoses or containers when filling that have been approved for use with drinking water.
- ▶ Thoroughly rinse filling hose or container with drinking water before use (2 to 3 times capacity).
- ▶ Empty filling hose or container completely after use and close openings of the filling hose or container.
- ▶ Water left standing in the water tank or in the water pipes becomes undrinkable after a short period. Therefore, before each use of the vehicle, thoroughly clean the water pipes and the water tank. After each use of the vehicle completely empty the water tank and the water pipes.
- ▶ In the case of lay-ups lasting more than a week disinfect the water system before using the vehicle (see chapter 11).



- ▷ If the vehicle is not used for several days or if it is not heated when there is a risk of frost, empty the entire water system. Make sure that the 12 V power supply on the panel is switched off. Otherwise, the water pump will overheat and may get damaged. Leave the water taps on in central position. Leave the safety/drainage valve (if there is one) and all drain cocks open. Frost damage to appliances, frost damage to the vehicle and deposits in water-carrying components can be avoided in this way.
- ▷ The water pump will overheat without water and can get damaged. Never operate water pump when the water tank is empty.

The vehicle is equipped with a fitted water tank. An electric water pump pumps the water to the individual water taps. Opening a water tap automatically switches on the water pump and pumps water to the tap.

A canister or a waste water tank collects the waste water.



- ▷ Before using the water fittings: Connect the 230 V power supply and switch on the 230 V automatic circuit breaker, or connect the caravans electrics to the towing vehicle. Otherwise the water pump will not work. (This only applies to caravans that are not equipped with a separate battery.)
- ▷ When the water tank is re-filled, an air bubble may form at the bottom of the pump. This air bubble will prevent water from being drawn in. Shake the water pump up and down energetically in the water.

10.2 Water system



- ▶ When filling the water tank, observe the maximum permissible gross weight of the vehicle. Luggage must be reduced accordingly when the water tank is full.

10.2.1 Water tank 22 l with external flap (special equipment)

The water tank is mobile or portable.

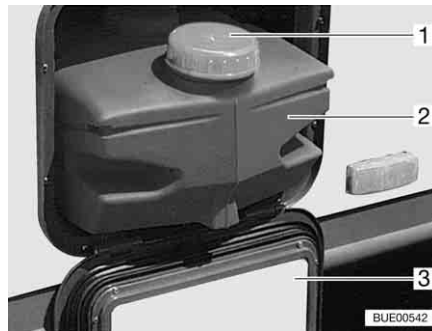

Fig. 188 Water tank 22 l

When transporting the water tank, close it with the cap (Fig. 188,1).

Filling the water tank with drinking water:

- Close all water taps.
- Open service flap (Fig. 188,3) (see chapter 6).
- Pull the water pump out of the water tank.
- Pull out the water tank (Fig. 188,2).
- Clean or disinfect water tank.
- Fill the water tank with drinking water.

Pouring water:

- Open the water taps.

Emptying the water tank:

- Close all water taps.
- Open service flap (Fig. 188,3) (see chapter 6).
- Pull the water pump out of the water tank.
- Pull out the water tank (Fig. 188,2) and empty it.

10.2.2 Water tank 25 l/40 l (partially special equipment)

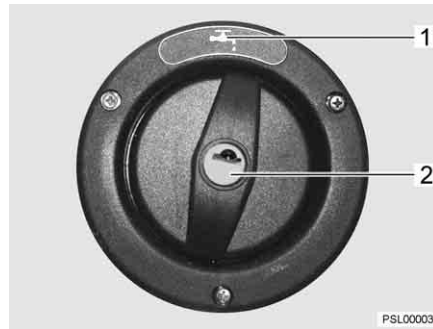

Fig. 189 Drinking water filler neck

The drinking water filler neck is on the right or left side of the vehicle, depending on the model.

The drinking water filler neck is indicated by the symbol "🔑" (Fig. 189,1). The cap is open and closed using the key for the external flap locks.

The water tank is built into the seating group.

- Opening:*
- Insert key into locking cylinder (Fig. 189,2) and turn a quarter turn in an anticlockwise direction.
 - Remove cap.

- Closing:*
- Place cap on the drinking water filler neck.
 - Turn key one quarter turn in a clockwise direction.
 - Remove key.
 - Check that the cap sits firmly on the drinking water filler neck.



Fig. 190 Water tank

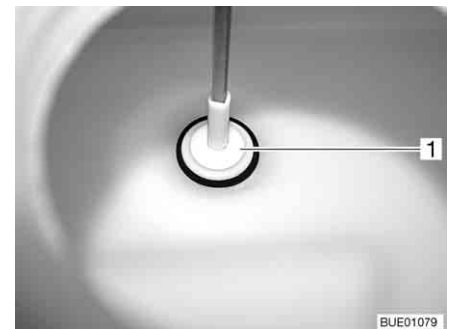

Fig. 191 Stopper

Filling the water tank with drinking water:

- Open drinking water filler neck (Fig. 189) (see chapter 6).
- Clean or disinfect water tank.
- Fill the water tank with drinking water.

Pouring water:

- Open the water taps.

Emptying the water tank:

- Close all water taps.
- Turn the handle (Fig. 190,1) on the water tank in an anticlockwise direction as far as it will go. The stopper (Fig. 191,1) at the bottom of the tank is lifted.

- Let the water drain out.
- Turn the handle (Fig. 190,1) on the water tank in a clockwise direction as far as it will go. The stopper (Fig. 191,1) at the bottom of the tank closes the drain.

10.2.3 Filling the water system



- ▶ When filling the water tank, observe the maximum permissible gross weight of the vehicle. Luggage must be reduced accordingly when the water tank is full.



- ▷ The water pump will overheat without water and can get damaged. Never operate water pump when the water tank is empty.

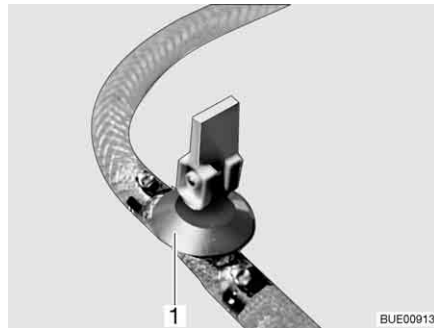

Fig. 192 Drain cock (with rocking lever)

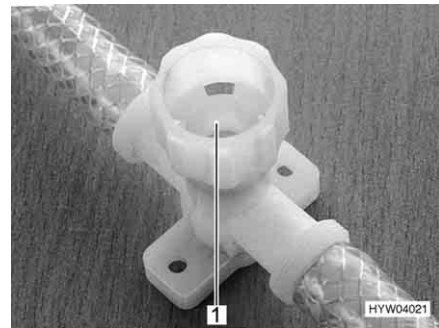

Fig. 193 Drain cock (with twist cap)

- Position the vehicle horizontally.
- Connect the 230 V power supply and switch on the 230 V automatic circuit breaker. If the vehicle is equipped with a self-sufficiency package with battery, it is not necessary to connect it to a 230 V power supply.
- Clean or disinfect water system.
- Close all water taps.
- Switch off the boiler.
- Close all drain cocks. To do this, position the drain cock's rocking lever (Fig. 192,1) horizontally or turn the drain cock's cap (Fig. 193,1) in a clockwise direction.
- Close the drainage opening of the water tank.
- Fill the water tank with drinking water. Use a water hose, a water canister with a funnel or similar for filling.
- Set all the water taps to "Hot" and open them. The water pump is turned on. The warm water pipes are filled with water.
- Keep the taps open until the water flowing out of the taps has no bubbles in it. This is the only way to ensure that the boiler is full of water.
- Set all water taps to "Cold" and leave them open. This will fill the cold water pipes with water.
- Keep the taps open until the water flowing out of the taps has no bubbles in it.
- Close all water taps.
- Check that the cap on the water tank is not leaking.

10.2.4 Emptying the water system



- ▷ If the vehicle is not used for several days or if it is not heated when there is a risk of frost, empty the entire water system. Make sure that the 12 V power supply on the panel is switched off. Otherwise, the water pump will overheat and may get damaged. Leave the water taps on in central position. Leave the safety/drainage valve (if there is one) and all drain cocks open. Frost damage to appliances, frost damage to the vehicle and deposits in water-carrying components can be avoided in this way.



- ▷ Take note of the environmental tip in this chapter.

To empty and ventilate the water system, proceed as follows. Frost damage and deposits are avoided in this way:

- Position the vehicle horizontally.
- Switch off the 230 V power supply on the 230 V automatic circuit breaker.
- Open all drain cocks. To do this turn the drain cock's cap in an anticlockwise direction or set the drain cock's rocking lever in a vertical position.
- Open the drainage opening of the water tank.
- Set water tap in kitchen and shower compartment (toilet compartment) in an exact central position (hot – cold), and open.
- Hang the shower handset up in the shower position.
- Remove the cap of the water tank.
- Check whether the water tank is completely empty.
- Blow out the remaining water in the water pipes (max. 0.5 bar).
- Empty the waste water tank. Take note of the environmental tip in this chapter.
- Empty toilet cassette. Take note of the environmental tip in this chapter.
- After emptying, leave all water taps open in the central position.
- Leave all drain cocks open.

10.3 Waste water installation

10.3.1 Waste water tank (special equipment)



- ▶ Before commencing the journey, empty the waste water tank.



- ▷ If there is any risk of frost, empty the waste water tank.
- ▷ Never pour boiling water directly into the sink outlet. Boiling water could cause deformation and leaks in the waste water pipe system.



- ▷ Only empty the waste water tank at disposal stations, camping sites or caravan sites especially provided for this purpose.

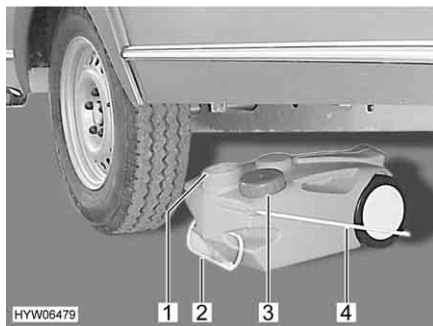

Fig. 194 Waste water tank, mobile

Emptying:

- Use the cap (Fig. 194,3) to close the opening of the waste water tank (Fig. 194,1).
- Use the handle (Fig. 194,2) to pull out the waste water tank.
- Fold the carrying handle (Fig. 194,4) up and upright the waste water tank.
- Completely empty the waste water tank at disposal stations that are especially provided for this purpose.

10.3.2 Warming unit of waste water pipes (special equipment)

In order to prevent waste water pipes from freezing, the waste water pipes can be electrically warmed. The section 9.2.7 describes how to operate this warming unit.

10.4 Toilet compartment



- ▷ Do not transport any loads in the shower tray. The shower tray or other items of equipment in the toilet compartment can be damaged.



- ▷ For ventilation purposes during or after a shower, and for drying wet clothing, close the toilet compartment door and open the window or the toilet compartment skylight. This improves the air circulation.
- ▷ Close the shower curtain completely when showering, so that no water is able to enter the area between the wash room wall and the shower tray.
- ▷ After taking a shower, rinse soap residue from the shower tray, otherwise cracks can appear in the shower tray over time.
- ▷ After using the shower, wipe it dry to prevent moisture from collecting.
- ▷ Further information about cleaning the toilet compartment can be found in the section 11.2.

10.5 Toilet



- ▷ If there is any risk of frost and the vehicle is not heated, empty the sewage tank (cassette).
- ▷ Do not sit on the lid of the toilet. The lid is not designed to bear the weight of a person and could break.
- ▷ Use a suitable chemical for this toilet. The ventilation will merely remove the odour but not germs and gases. Germs and gases will have a detrimental effect on the sealing rubbers.



- ▷ Further information can be obtained in the manufacturer's instruction manual.



- ▷ Only empty the sewage tank (cassette) at disposal stations, at camping sites or caravan sites, that are especially provided for this purpose.

10.5.1 Preparing toilet



- ▷ The sewage tank (cassette) can only be taken out if the sliding trap is closed.

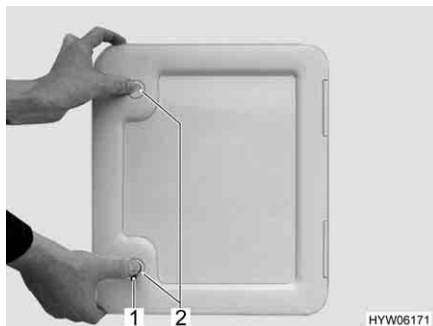

Fig. 195 Flap for sewage tank



Fig. 196 Sewage tank (example)

- Open the flap for the sewage tank on the outside of the vehicle. Insert the key into the locking cylinder of the push-button lock (Fig. 195, 1) and turn a quarter turn.
- Remove the key.
- Press both push-button locks (Fig. 195, 2) simultaneously with your thumb and open the flap.
- Pull the retaining clip (Fig. 196, 1) upwards and lift the sewage tank (Fig. 196, 2) straight up as far as it will go.
- Tilt the sewage tank slightly and remove fully.

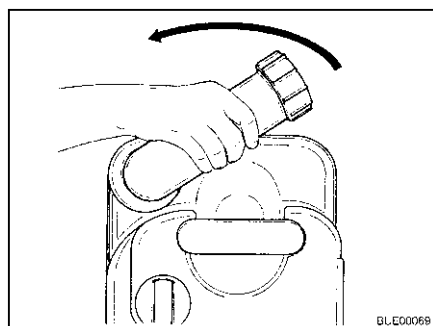

Fig. 197 Turning drainage neck

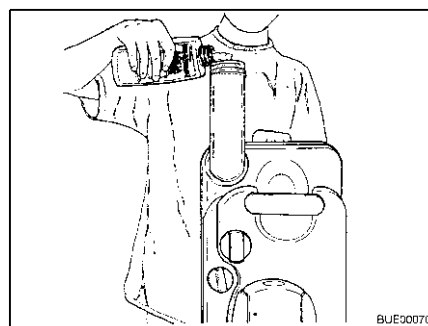

Fig. 198 Filling with sanitary liquid

- Put the sewage tank down vertically.
- Turn the drainage neck upwards (Fig. 197).
- Remove the cap of the drainage neck.
- Fill the stated amount of sanitary liquid into the sewage tank (Fig. 198).
- Then add enough water so that the bottom of the sewage tank is completely covered.
- Close drainage neck with the cap.
- Return the drainage neck to its original position.
- Push the sewage tank back to its original position without applying any force.
- Ensure that the sewage tank is secured by the retaining clip.
- Lock the flap for the sewage tank.

10.5.2 Swivel toilet

The flushing of the Thetford toilet is fed directly from the water system of the vehicle. The toilet bowl can be moved into the optimal position.



Fig. 199 Thetford toilet bowl, swivelling

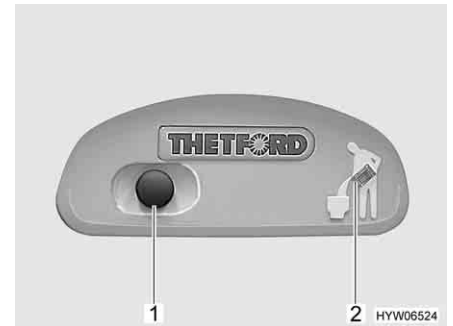

Fig. 200 Flush button/indicator lamp Thetford toilet

Flushing:

- Before flushing open the sliding trap of the Thetford toilet. To do this, push the slide lever (Fig. 199,1) in an anticlockwise direction.
- For flushing, press the blue flush button (Fig. 200,1).
- After flushing close the sliding trap. To do this push the slide lever in a clockwise direction.

The indicator lamp (Fig. 200,2) goes on whenever the Thetford cassette has to be emptied.

10.5.3 Toilet with fixed seat

The flushing of the toilet is fed from the water system of the vehicle.

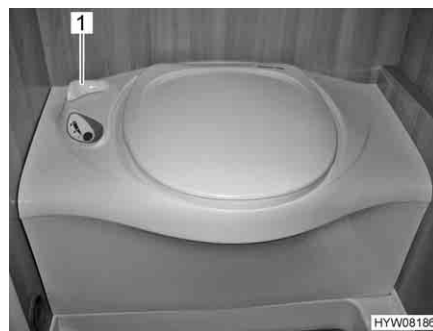

Fig. 201 Thetford toilet

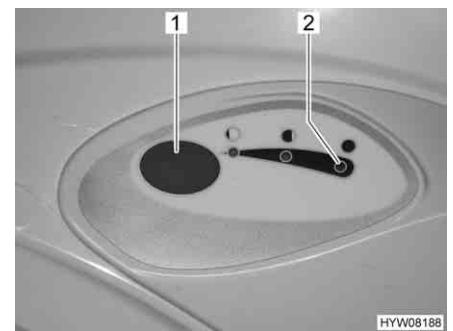

Fig. 202 Flush button/indicator lamp Thetford toilet

Flushing:

- Before flushing open the sliding trap of the Thetford toilet. To do this, turn the slide lever (Fig. 201,1) in an anticlockwise direction.
- For flushing, press the blue flush button (Fig. 202,1).
- After flushing close the sliding trap. To do this turn the slide lever (Fig. 201,1) in a clockwise direction.

The indicator lamp (Fig. 202,2) lights up whenever the sewage tank has to be emptied.

10.5.4 Emptying the sewage tank



- ▷ The sewage tank can only be taken out if the sliding trap is closed.

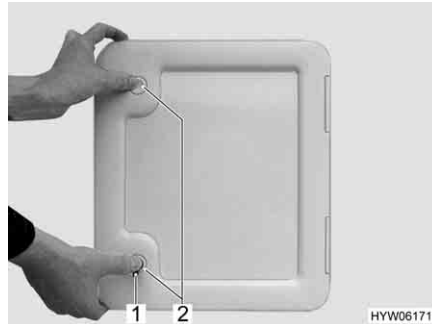

Fig. 203 Flap for the sewage tank



Fig. 204 Sewage tank (example)

- Slide the slide lever on the toilet bowl in a clockwise direction. The sliding trap is closed.
- Open the flap for the sewage tank on the outside of the vehicle. Insert the key into the locking cylinder of the push-button lock (Fig. 203,1) and turn a quarter turn in a clockwise direction.
- Remove the key.
- Press both push-button locks (Fig. 203,2) simultaneously with your thumb and open the flap for the sewage tank.
- Pull the retaining clip (Fig. 204,1) upwards and pull out the sewage tank (Fig. 204,2).
- Completely empty the sewage tank at disposal stations that are especially provided for this purpose.



- ▷ Actuate the aeration knob on the sewage tank with your thumb to empty it completely.

Chapter overview

This chapter contains instructions regarding the care of the vehicle.

The instructions address the following topics:

- exterior of the vehicle
- interior
- water system
- extractor hood
- air conditioning unit
- winter operation

At the end of the chapter there is a checklist of measures you must carry out if you are not going to use the vehicle for an extended period of time.

The checklist address the following topics:

- temporary lay-up
- winter lay-up
- start-up after a lay-up

11.1 External care

11.1.1 General

Standard external care consists of regular washing. The use and the environmental conditions will determine how often the vehicle needs to be washed. Wash the vehicle more frequently in areas which are exposed to heavy air pollution or heavy traffic or roads treated with de-icing salts. If the vehicle is exposed to salty and humid air (coastal areas, humid climates), wash the vehicle more frequently.

Do not park under trees if at all possible. The resin-like discharge which many trees secrete, give the paintwork a matt look and can promote the onset of corrosion.

Wash off bird droppings straight away and thoroughly, as the acid it contains is extremely corrosive.

11.1.2 Washing with a high-pressure cleaner



- ▷ Do not clean the tyres with a high-pressure cleaner. The tyres might be damaged.
- ▷ Do not spray external applications (deco-films) directly with the high-pressure cleaner. The external applications could come off.

Before cleaning the vehicle with a high-pressure cleaner, observe the operating instructions of the high-pressure cleaner.

When cleaning with the nozzle for circular jet between the vehicle and the cleaning nozzle, maintain a minimum distance of approx. 700 mm.

Take into consideration that the jet of water comes out of the cleaning nozzle with pressure. The vehicle may be damaged by incorrect handling of the high-pressure cleaner. The temperature of the water should not be above 60 °C. Keep the jet of water in constant movement during the washing process. Do not direct the water jet at clearances, built-in electrical parts, plugs, seals, the ventilation grill or the skylights. The vehicle may be damaged or water may enter the interior.

11.1.3 Washing the vehicle



- ▷ Never clean the vehicle in the car wash. Water can enter the refrigerator grills, the waste gas vents, the ventilation of the extractor hoods or the forced ventilations. The vehicle could be damaged.
- Wash the vehicle only on a washing site intended for this purpose. Avoid full sunshine. Observe environmental measures.
- Only clean external applications and synthetic parts with plenty of warm water, dish washing liquid and soft cloth.
- Wash down the vehicle with plenty of water, a clean sponge or a soft brush. In the case of stubborn dirt add dish washing liquid to the water.
- Painted exterior walls may also be cleaned with a caravan cleaner.
- Add-on parts made of glass-fibre reinforced plastic (GRP) require a regular follow-up treatment with a polisher. This way these parts will not turn yellow and the sealing of the surface remains intact.
- Treat rubber seals of doors and storage flaps with talc.
- Treat locking cylinder of doors and storage flaps with graphite dust.

11.1.4 Windows of acrylic glass



Acrylic glass windows are delicate and require very careful handling.

- ▷ Never rub acrylic glass windows dry as dust particles might damage the surface!
- ▷ Only clean acrylic glass windows with plenty of warm water, some dish washing liquid and a soft cloth.
- ▷ Never use glass cleaning agents with chemical, abrasive or alcohol-containing additives. Premature brittleness of the panes and associated cracks may result from their use.
- ▷ Avoid contact of cleansing agents used for the body (e.g. tar- or silicone-removing agents) with acrylic glass.
- ▷ Do not clean vehicle in car wash.
- ▷ Do not attach stickers to the acrylic glass windows.
- ▷ Having cleaned the vehicle rinse acrylic glass with sufficient clear water.
- ▷ Apply talcum powder to rubber seals.



- ▷ An acrylic glass cleanser with antistatic effect is suitable for a follow-up treatment. Small scratches can be treated with an acrylic glass polish. These agents are available at the accessories shop.

11.1.5 Hot galvanized chassis

Salt deposits damage the hot galvanized chassis and can cause white rust. But so-called white rust represent no defects. It is only a visual damage.

The most frequent causes for white rust are:

- Abrasives and de-icing salts (e.g. when driving during winter months)
- Condensation (e.g. by covering the vehicle with plastic foils or awning)
- Humidity (e.g. by parking the vehicle in high grass, in puddles or sludge)
- Cleaning agents (e.g. by cleaning with aggressive cleaning agents)
- Snow (e.g. by standing too long in snow)
- Defective ventilation (e.g. by covering with aprons in the floor area)

To avoid formation of white rust or to remove any existing white rust, we recommend the following method:

- After driving in winter, rinse out the hot galvanized surfaces with clean water.
- If hot galvanized parts are affected by white rust, clean with a zinc cleaner (e.g. Poligrat).

11.1.6 Underbody

The underbody of the vehicle is partly coated with an age-resistant underbody protection. Should the underbody protection be damaged, repair immediately. Do not treat areas coated with underbody protection with spray oil.



- ▷ Only use products approved by the manufacturer. Our authorised dealers and service centres will be happy to advise you.

11.1.7 Manoeuvring system

Clean and lubricate the manoeuvring system in regular intervals.

Cleaning:

- Remove any coarse road grime from the drive units. To do so, hose the manoeuvring system down with water.
- Remove any stones, twigs and other objects which are caught.
- After cleaning, check all parts of the manoeuvring system for damage.

Lubricate the guides on the manoeuvring system at least once a year, e.g. before winter storage.



- ▶ The lubricant must not find its way onto the rollers or tyres. Otherwise, the rollers and tyres will lose their grip.

Lubricating:

- Lightly spray the guides for the drive units with a spray oil or with a similar water-repelling lubricant.
- Swivel the drive units onto and away from the tyres several times to distribute the lubricant evenly.

11.2 Interior care



- ▷ If possible, treat stains immediately.
- ▷ Acrylic glass windows are delicate and require very careful handling (see section 11.1.4).
- ▷ Synthetic parts in the toilet and living area are very delicate and should be treated with care. Do not use solvents, alcohol-containing cleansers or scourers. This procedure will help you to avoid brittleness and formation of cracks.
- ▷ Hair colourants, nail varnish, cigarette ash and similar substances may cause permanent stains or discolouration. For this reason, you should prevent these substances from getting onto plastic parts. If they do get onto plastic parts, you should remove these substances immediately.
- ▷ Do not pour any corrosive agents into the drain holes. Never pour boiling water directly into the drain holes. Corrosive agents and boiling water cause damage to drainage pipes and siphon traps.
- ▷ Do not use vinegar based products to clean the toilet and water system, or for decalcification of the water system. Vinegar-based products may cause damage to seals or parts of the installation. Use standard decalcifying products for decalcification.
- ▷ Save water. Mop up all remaining water.
- ▷ Vacuum off carpets and cushions with a suitable brush attachment.



- ▷ For information about the use of maintenance products, our representatives and service centres will be glad to advise.
- Surface and knobs of furniture, lamps and synthetic parts in the toilet and living area should be cleaned with water and a wool cloth. A mild cleanser may be added to the water. If required, use furniture polish for the painted surfaces.
- Clean upholstery with dry foam specially manufactured for the use on upholstery or with the foam of a mild detergent. Do not wash upholstery. Always have it cleaned. Protect upholstery from direct sunlight so that it does not lose its colour.
- Clean upholstery made of novalife[®] with clear water only.
- Leather covers should be cleaned with a cotton cloth and a mild soap (curd soap). Make sure that the leather is not soaked through and that no water seeps through the seams of the leather covers.
- Wash panel curtains and gathered blinds. When washing observe washing instructions on the product. The sticks may be removed for washing.
- Vacuum clean the carpet, if necessary clean with carpet shampoo.
- Clean PVC-floor covering with a mild, soapy cleanser for PVC floors. Do not place carpet on wet PVC-floor covering. The carpet and the PVC-floor covering may stick together.
- Clean the sink cover manually using water and washing-up liquid. Do not clean the sink cover in the dishwasher.
- Never clean the sink or the gas cooker with a scourer. Avoid anything which may cause scratching or grooves.
- Clean the burners on the gas cooker using a damp cloth only. Prevent any water from penetrating the burner covers. Water may damage the burners on the gas cooker.

- Brush insect screens on doors, windows and skylights with a soft brush or vacuum with the brush attachment of the vacuum cleaner.
- Brush blinds with a soft brush or vacuum with the brush attachment of the vacuum cleaner. Grease or stubborn dirt may be removed with a mild soap at 30 °C (curd soap).
- Brush Roman shades with a soft brush or vacuum with the brush attachment of the vacuum cleaner. Grease or stubborn dirt may be removed with a mild soap at 30 °C (curd soap).

11.3 Water system

11.3.1 Cleaning the waste water tank

Clean the waste water tank after every use.

- Empty the waste water tank.
- Open the cleaning opening on the waste water tank and the drain cock.
- Thoroughly rinse out the waste water tank with fresh water.
- If possible, clean waste water sensors through the cleaning opening by hand.

11.3.2 Cleaning the water tank



Fig. 205 Cleaning opening water tank

- Empty the water tank and close the drainage opening.
- Remove the cap (Fig. 205,1) of the water tank.
- Fill water tank with water and some washing-up liquid (do not use any scourers).
- Using a trade standard brush for washing dishes, scrub the water tank until there is no longer any visible deposit.
- Scrub also the pump housing.
- If possible, clean fresh water sensors through the cleaning openings by hand.
- Rinse water tank with copious amounts of drinking water.

11.3.3 Cleaning the water pipes



- ▷ Only use suitable cleaning agents as sold by the specialist trade.
- ▷ The cleaning agent must meet national regulations and be approved (if required).



- ▷ Collect any emerging mixture of water and cleaning agent for correct disposal.

- Empty the water system.
- Close all drainage openings and drain cocks.
- Fill mixture of water and cleaning agent into the water tank. Observe the manufacturer's instructions regarding the mixing ratio.
- Open the drain cocks one by one.
- Leave the drain cocks open until the mixture of water and cleaning agent has reached the respective drain.
- Close the drain cocks.
- Set all the water taps to "Hot" and open them.
- Leave the water taps open until the mixture of water and cleaning agent has reached the drain.
- Set all water taps to "Cold" and open them.
- Leave the water taps open until the mixture of water and cleaning agent has reached the drain.
- Close all water taps.
- Flush the toilet several times.
- Allow the cleaning agent to act in accordance with the manufacturer's instructions.
- Empty the water system. Collect the mixture of water and cleaning agent for correct disposal.
- For rinsing fill the entire water system with drinking water and empty again several times over.

11.3.4 Disinfecting the water system



- ▷ Only use suitable disinfectants as sold by the specialist trade.
- ▷ The disinfectant must meet national regulations and be approved (if required).



- ▷ Collect any emerging mixture of water and disinfectant for correct disposal.

When disinfecting the water system, proceed the same way as when cleaning the water pipes (see section 11.3.3). Simply use disinfectant instead of cleaning agent.

11.4 Extractor hood

Clean the extractor hood filter occasionally. How often cleaning is necessary depends on how often the extractor hood is used. Do not wait to clean the filter until the performance of the extractor hood has noticeably decreased.

Cleaning the filter: ■ Wash the filter with warm water and some washing-up liquid.

11.5 Air conditioning unit

11.5.1 Dometic



Fig. 206 Air conditioning unit (Dometic)

A lint filter and an activated carbon filter are each located in the lower part of the air conditioning system ceiling unit (Fig. 206,2) behind the ventilation grilles (Fig. 206,1 and 3). The lint filters must be cleaned at regular intervals and replaced if necessary. The manufacturer recommends replacing the activated carbon filter yearly.

On the left side of the ceiling unit (outside of the vehicle) is located the drainage opening for the condensation. Keep the drain openings free from dirt, leaves or similar to allow the condensation to be drained.

11.5.2 Telair

Every now and then clean the filter and the ventilation grilles on the outside of the housing. How often cleaning is necessary depends on how often the air conditioning unit is used. Do not wait to clean the filter and the ventilation grill until the performance of the air conditioning unit has noticeably decreased.



▷ Only use mild cleaning solutions to clean the filter, never use benzene or solvents.

Cleaning the filter: ■ Wash the filter with warm water and some washing-up liquid.
■ Allow the filter to dry thoroughly before reassembly.

Cleaning the ventilation grill: ■ Use a brush to remove coarse dirt or deposits from the external ventilation grilles. If a cleaning solution is used, ensure that no water ingresses into the inside of the housing.

11.5.3 Truma



Fig. 207 Air conditioning unit (Truma)

A lint filter (Fig. 207, 1) for the air circulation suction system is at the front of the air conditioning unit. The lint filter must be cleaned at regular intervals, at least twice a year however, and replaced if necessary.

The condensation drain is under the floor of the vehicle. Keep the drain hose free from dirt, leaves or similar to allow the condensation to be drained.

11.6 Winter care

De-icing salt damages the underbody and the parts open to water spray. We recommend that you wash the vehicle more frequently during wintertime. Mechanical and surface treated parts and the underside are under particular strain, and should therefore be cleaned thoroughly.



- ▷ If there is any risk of frost, always run heater at a minimum of 15 °C. Switch the circulation fan (if there is one) to automatic. In the case of extreme external temperatures, the furniture flaps and doors should be left slightly open. The inflowing warm air can help prevent the freezing of water pipes, for example, and counteract the formation of condensation in the storage spaces.
- ▷ If there is any risk of frost, cover the outside surface of the windows with winter insulation mats.
- ▷ Keep the waste gas vent, skylights with forced ventilation and mushroom-shaped vents free of snow. For a roof vent, use a vent extension which is at least 10 cm (4 inch) long.

11.6.1 Preparations

- Check the vehicle for paint and rust damage. Repair damage as necessary.
- Make certain that water cannot penetrate the automatic floor ventilation system and the heater.
- Use a wax-based rust inhibitor to protect the metal parts of the underbody.
- Use appropriate protection for external painted surfaces.

11.6.2 Winter operation

During winter operation, condensation develops when the vehicle is occupied under low-temperature conditions. To ensure good interior air quality and avoid vehicle damage from condensation, sufficient ventilation is essential.

- Attach vent extension with a length of at least 10 cm.
- When heating the vehicle, the heater should be at the highest setting and roof storage cabinets, curtains and blinds should be opened. This ensures optimal ventilation.
- If the vehicle is equipped with a circulation fan, always switch the fan on when the heater is on. Otherwise, there is a danger of overheating for the heater!
- In the morning, lift up all cushions, air out storage boxes and dry any damp areas.



- ▷ If condensation has still developed, just wipe it off.
- ▷ It is only possible to guarantee unrestricted operation during winter in connection with the "winter package" from the original equipment.

11.6.3 At the end of the winter season

- Thoroughly clean the underbody. When this is done, corrosion-inducing anti-freeze agents (salts, alkaline residues) are removed.
- Clean the exterior and use regular car wax to protect metal surfaces.
- Remove vent extension.

11.7 Lay-up



11.7.1 Temporary lay-up





- ▶ If the vehicle has been stationary for a long period (approx. 10 months) have the braking and gas systems checked by an authorised specialist workshop.
- ▶ Take into consideration that water is undrinkable after only a short time.
- ▶ Animal damage to cables can lead to short circuits. Fire hazard!

Before laying up the vehicle, go through the following checklist:

Chassis

Activities	Done
Lubricate the moving parts of the caravan coupling  ▶ Do not lubricate the friction pads on the stabiliser!	
Jack up caravan with suitable support so that the wheels do not bear any load, or move caravan every four weeks. This prevents pressure points on the tyres and wheel bearings  ▶ Never use the fitted corner steadies as a car jack but only external support.	
Protect the tyres from direct exposure to the sun. Danger of formation of cracks!	

	Activities	Done
	Inflate tyres up to the recommended maximum pressure Always provide for sufficient ventilation in the underbody area  ▷ Humidity or lack of oxygen e.g. by covering with plastic film may cause optical irregularities to the underbody.	
Body	All vents should be sealed with the appropriate caps and all other openings (apart from forced ventilations) should also be sealed. This prevents animals (e.g. mice) from gaining entry Air the interior, all storage spaces accessible from the outside, and the parking space (e.g. garage) every 3 weeks in order to prevent the occurrence of condensation and resulting mould formation	
Interior	Place upholstery in an upright position for ventilation, and cover Clean refrigerator Allow refrigerator and freezer compartment doors to remain slightly open Search for traces of animals that have gained entry Disconnect the flat screen from the mains and, if necessary, remove it from the vehicle	
Gas system	Close regulator tap on the gas bottle Close all gas isolator taps Always remove gas bottles from the gas bottle compartment, even if they are empty	
Electrical system	Spray the contacts on the thirteen-pin connector with contact spray Fully charge the living area battery (if there is one)  ▷ Charge the battery for at least 20 hours before laying up. Disconnect the living area battery from the 12 V power supply	
Water system	Empty the entire water system. Blow out the residual water from the water pipes (0.5 bar max.). Leave the water taps on in central position. Leave the safety/drainage valve (if there is one) and all drain cocks open. Observe the notes in chapter 10	

11.7.2 Winter lay-up

Additional measures are required if laying up the vehicle over winter:

	Activities	Done
Chassis	Clean body and underbody thoroughly and spray with hot wax or protect with varnish	
	Rectify damage to the paintwork	
Body	Clean vehicle from outside thoroughly	
	Keep the forced ventilation open	
	Clean and grease installed supports	
	Clean and grease all door and flap hinges	
	Brush oil or glycerine on all locking mechanisms	
	Rub all rubber seals with talc	
	Use graphite dust to treat locking cylinders	
Interior	Position de-humidifiers	
	Remove upholstery from the vehicle and store in a dry place	
	Air the interior every 3 weeks	
	Empty all cabinets and storage compartments, open flaps, doors and drawers	
	Thoroughly clean the interior	
	If there is a risk of frost, do not leave the flat screen in the vehicle	
Electrical system	Remove living area battery (if there is one) and store in a place protected from frost (see chapter 8)	
Water system	Clean the water system using a cleaning agent from a specialised store	
Complete vehicle	Clean the awning area and store in a dry place	
	Arrange the tarpaulins in such a way that the ventilation openings are not covered, or use porous tarpaulins	

11.7.3 Starting up the vehicle after a temporary lay-up or after lay-up over winter

Go through the following checklist before start-up:

	Activities	Done
Chassis	Check the tyre pressure on all tyres	
	Check the tyre pressure of the spare wheel	
Body	Check the functioning of the fitted supports	
	Check that the windows and skylights are working properly	
	Check that all the external locks are working, such as the external flaps, the filler neck and the conversion door	
	Remove the cover from the waste gas vent of the heater (if there is one)	
	Remove the winter cover from the refrigerator grills (if there is one)	
Gas system	Put the gas bottles in the gas bottle compartment, tie down and connect to the gas pressure regulator	
Electrical system	Connect to 230 V power supply using the external socket	
	Fully charge the living area battery (if there is one)	
	 ▷ Charge the battery for at least 20 hours after lay-up.	
	Connect the living area battery (if there is one) with the 12 V power supply (see chapter 8)	
	Check that the electrical system are working, e.g. interior light, socket and all installed electrical appliances	
Water system	Disinfect water pipes and water tank	
	Close all drain cocks and water taps	
	Check the water taps, drain cocks and water distributors for leaks	
Appliances	Check the function of the appliances	

Chapter overview

This chapter contains instructions about inspection and maintenance work concerning the vehicle.

The maintenance instructions address the following topics:

- stabilisers
- manoeuvring system
- braking system
- doors
- Alde hot-water heater
- replacing light bulbs
- spare parts

At the end of the chapter you will find important instructions on how to obtain spare parts.

12.1 Inspection work

Like any technical appliance, the vehicle must be inspected at regular intervals.

This inspection work must be carried out by qualified personnel.

Special technical knowledge, which cannot be taught within the framework of this instruction manual, is required for these tasks. Personnel possessing this technical knowledge are available for assistance at all service centres. Their experience and regular technical instruction by the factory as well as equipment and tools guarantee expert and up-to-date inspection of the vehicle.

Have the "First Programmed Inspection" carried out at a service centre 12 months after initial registration.

Further inspections should be carried out once a year.

The service centre in charge will confirm the work performed.



- ▷ Observe the inspections indicated by the manufacturer and have them carried out at the specified intervals. The value of the vehicle is thus preserved.
- ▷ The confirmation of the inspection work carried out serves as valid proof in the event of damage and guarantee claims.

12.2 Maintenance work

As with every machine, this vehicle requires maintenance. The extent and frequency of the maintenance work required depend on conditions of operation and use. More difficult operating conditions make it necessary to service the vehicle more often.

Have the appliances serviced at the intervals specified in the corresponding instruction manuals.

12.3 Stabilisers

12.3.1 General

Clean the stabiliser and the coupling head regularly. Use either thinners or white spirit. When lubricating the stabiliser ensure that no lubricant is on the friction pads.

12.3.2 AKS 1300

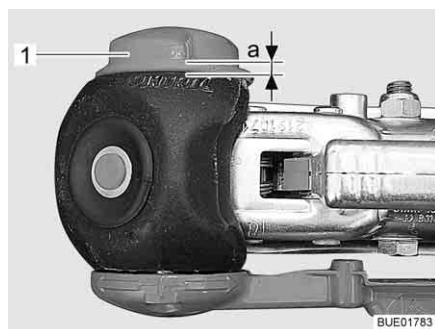

Fig. 208 Friction control

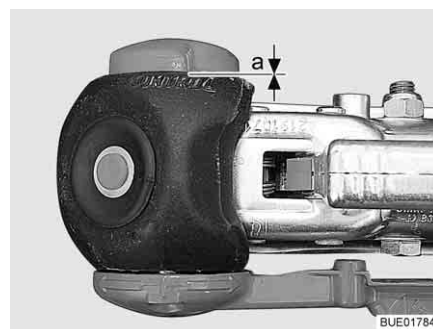

Fig. 209 Friction control

Checking the stabilising device (on the side of the friction pads)

Prerequisite: AKS 1300 connected, ball diameter 50 mm

- Turn the handwheel (Fig. 208,1), until it can be heard and felt that the torque limiting mechanism grates. Rotation direction: clockwise.
- Check distance a:
 - Distance $a > 0$ (Fig. 208): Wear within the permissible range.
 - Distance $a = 0$ (Fig. 209): Check and, if necessary, replace the friction pads.



▷ Resetting the friction pads is not required.

12.3.3 AKS 3004



Fig. 210 Display friction pads, front and back

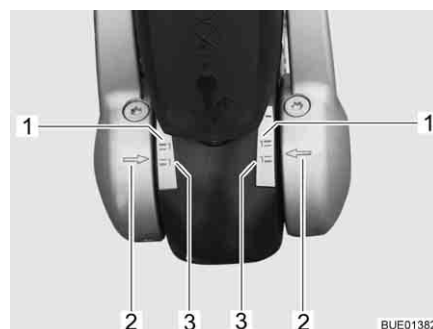

Fig. 211 Display friction pads, left and right

Stabilising device: Checking the friction pads

Prerequisite: AKS 3004 connected, ball diameter 50 mm

- Open the stabilising lever (Fig. 210,1).
- Close the stabilising lever until a resistance can be felt (the friction pads lie on the ball, they have not been tightened yet).

Friction pads, front and back

The check is made using the indicator in front of the coupling handle (Fig. 210,2).

- If the green marking is visible, the friction pads and the coupling head are okay.
- If the red marking is visible, the friction pads or the coupling head are worn out (< 49 mm). Replace the friction pads or the coupling head.

Side friction pads

The check is made using the indicator on the pressure pad.

- If the arrows on the pressure pad (Fig. 211,2) point to or below the green marking (Fig. 211,3), the friction pads are brand new.
- If the arrows on the pressure pad point to within the marked areas (Fig. 211,1 and 3), then the friction pads are slightly worn.
- If the arrows on the friction pad point to or above the red marking (Fig. 211,1), the friction pads are worn out. Replace the friction pads.



- ▷ Resetting the friction pads is not required.

12.4 Manoeuvring system



- ▷ When lubricating, ensure that no oil comes into contact with the drive rollers or tyres.

Following each use, remove coarse dirt from the drive elements.

Once a year (e.g. before laying up over winter) thoroughly clean and dry the manoeuvring system and lightly grease the guides of the drive elements.

To ensure that oil is distributed throughout the drive shafts, swing the drive rollers a few times onto the tyres and back again.

12.5 Braking system

Have maintenance work on the braking system carried out by a specialist workshop.

Look up the following table for the inspection deadlines.

First inspection	Braking system	Brake lining
After 1,500 km or after 6 months	Every 10,000 or 15,000 km or every 12 months	Every 5,000 km or every 12 months

12.6 Doors

To maintain gliding capability between springs and hinges, grease the conversion door hinges occasionally.



- ▷ We recommend either Molykote PG 65 or Vaseline as lubricants.

12.7 Alde hot-water heater



- ▷ Check the level of the heating fluid regularly on the compensator reservoir.
- ▷ During or after the first operating hours of the hot-water heater, the filling level may fall below the minimum mark. If this is the case, top up the heating fluid.
- ▷ We recommend to bleed the heating system after the initial heater operation and to check the glycol content.
- ▷ Have heating fluid changed by an authorised dealer or a service centre at intervals of approximately two years as corrosion-protection wears off after some time.
- ▷ Top up heating system with a water-glycol mixture (60 : 40) only. This mixture offers frost protection up to appr. -25 °C. When topping up hot-water heaters that are connected to the engine's cooling circuit, please observe the instructions in the instruction manuals of the manufacturers.



- ▷ Further information can be obtained in the manufacturer's instruction manual.

12.7.1 Checking the fluid level



Fig. 212 Compensator reservoir with panel



Fig. 213 Compensator reservoir without panel

- Switch off the hot-water heater and allow it to cool down.
- Check if the fluid level is between the marks "MIN" (Fig. 212,3 or Fig. 213,3) and "MAX" (Fig. 212,2 or Fig. 213,2) on the compensator reservoir (Fig. 212 or Fig. 213).

12.7.2 Topping up heating fluid

- Position the vehicle horizontally. This prevents the formation of bubbles.
- Switch off the hot-water heater and allow it to cool down.
- If necessary, unscrew or remove the panel (depending on the model).
- Open the rotary lid (Fig. 212,1 or Fig. 213,1) on the compensator reservoir.
- Remove cover.
- Check anti-freeze with an anti-freeze hydrometer. The frost protection content must be 40 % or correspond to a frost protection of -25 °C.
- Fill water frost protection mixture slowly into the compensator reservoir.



- ▷ The optimum fluid level is reached when the fluid in the compensator reservoir is 1 cm above the "MIN" mark when it is cooled down.

12.7.3 Bleeding the heating system



Fig. 214 Bleeding valve of hot-water heater

The bleeding valves are built in nearby the radiators.

- Switch off the hot-water heater and allow it to cool down.
- Open bleeding valve (Fig. 214,1) and leave open until no more air escapes.
- Close bleeding valve.
- Repeat this procedure at all bleeding valves.
- Check to see if the hot-water heater warms up.

12.8 Replacing bulbs, external



- ▶ Bulbs and light fittings can be extremely hot. Therefore, allow lights to cool down before changing bulbs.
- ▶ Store bulbs in a safe place inaccessible to children.
- ▶ Do not use any bulb that has been dropped or which shows scratches in its glass. The bulb might burst.



- ▷ A new bulb should not be touched with the fingers. Use a cloth when installing the new bulb.
- ▷ Use only bulbs of the same type and with the correct wattage (see section 12.8.4 "Types of bulbs for exterior lighting").
- ▷ If LEDs in lights are defect, contact an authorised dealer or service centre.

Types of bulbs

Different types of bulbs are used in the vehicle. Below, we have described how to change the different types of bulbs.

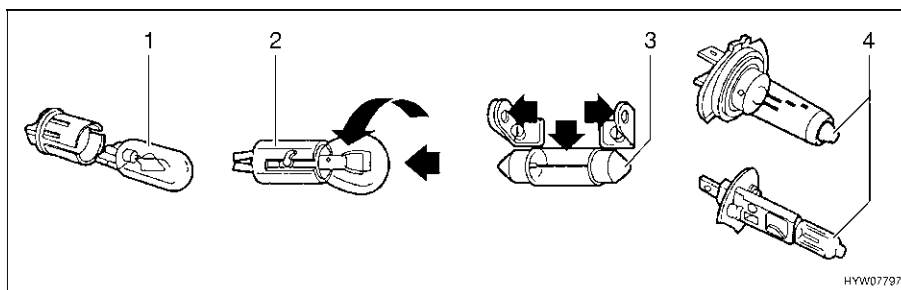
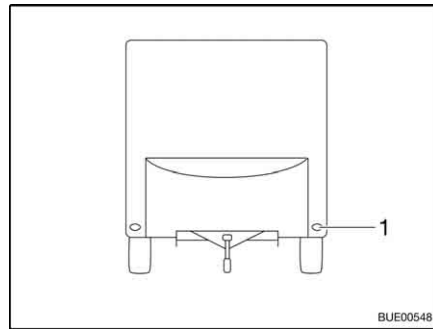

Fig. 215 Types of bulbs

Pos. in Fig. 215	Fixture type/bulb type	Changing
1	Plug-in fixture	To remove, pull out the bulb To mount, push the bulb into the socket with gentle pressure
2	Bayonet socket	To remove, press the bulb down and turn in an anticlockwise direction To insert, place the bulb in the socket and turn in a clockwise direction
3	Cylindrical bulbs	To remove and to insert, carefully bend the contacts of the lamp holder outwards
4	Halogen bulb	To remove, release retaining springs After inserting, hook the retaining springs again

12.8.1 Front lights



1 Front light

Fig. 216 Front lights

The front lights (Fig. 216,1) have LEDs. To change the LEDs, contact an authorised dealer or a service centre.

12.8.2 Rear lights



Fig. 217 Rear lights



Fig. 218 Rear lights (alternative)

- 1 Rear light
- 2 Brake light
- 3 Direction indicator
- 4 Reverse light
- 5 Fog tail light
- 6 Licence plate light
- 7 Brake light

- Undo five housing screws.
- Remove housing.
- Remove bulb.
- Put in a new bulb.
- Reassemble the lamp in the reverse order.



- ▷ Only replace third brake light (Fig. 217,7 or Fig. 218,7) completely.

12.8.3 Side lights

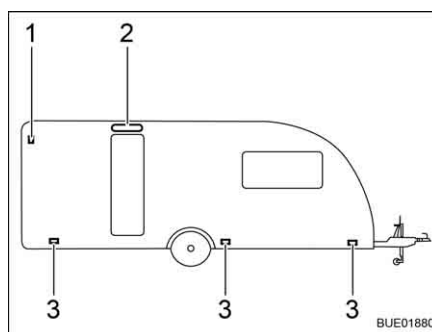

- 1 Side marker light
- 2 Awning light (partially special equipment)
- 3 Marker light

Fig. 219 Side lights

Marker lights

The marker lights (Fig. 219,3) are fitted in the lower part of the side wall of the vehicle.

Side marker light

The side marker light (Fig. 219,1) is fitted in the upper part of the side wall of the vehicle.

Awning light

The awning light (Fig. 219,2) is fitted in the upper part of the side wall of the vehicle.



- ▷ The lights have LEDs. To change the LEDs, contact an authorised dealer or a service centre.

12.8.4 Types of bulbs for exterior lighting

	Item no.	Exterior lighting	Type of bulb
Front	1	Front light	LED
Rear	1	Rear light	Ba15s 12 V 5 W
	2	Brake light	Ba15s 12 V 21 W
	3	Direction indicator	Ba15s 12 V 21 W orange
	4	Reverse light	Ba15s 12 V 21 W
	5	Fog tail light	Ba15s 12 V 21 W
	6	Licence plate light	LED
	7	Third brake light	LED
Side	1	Side marker light	LED
	2	Marker light	LED

12.9 Replacing bulbs, internal



- ▶ Bulbs and light fittings can be extremely hot. Therefore, allow lights to cool down before changing bulbs.
- ▶ Shut off the power supply on the safety cut-out in the 230 V fuse box before changing bulbs.
- ▶ Store bulbs in a safe place inaccessible to children.
- ▶ Do not use any bulb that has been dropped or which shows scratches in its glass. The bulb might burst.
- ▶ Halogen lamps can get very hot. When the light is switched on, there must always be a safety distance of 30 cm between light and flammable objects. Fire hazard!
- ▶ Do not replace the LEDs in lights with standard light bulbs. Risk of fire due to intense heat build up.



- ▷ A new bulb should not be touched with the fingers. Use a cloth when installing the new bulb.
- ▷ Only use bulbs of the same type and with the correct wattage.
- ▷ If LEDs in lights are defect, contact an authorised dealer or service centre.

12.9.1 Ceiling lamp

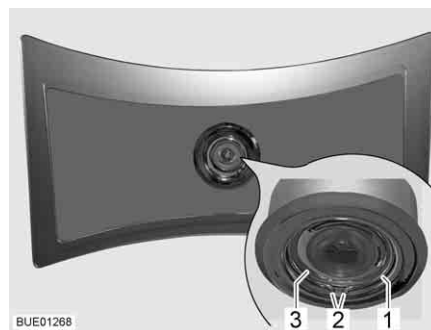

Fig. 220 Ceiling lamp

The ceiling lamp has LEDs.

Changing bulbs:

- Press the two ends (Fig. 220,2) of the spring ring (Fig. 220,1) together and remove.
- Remove the housing (Fig. 220,3) with LED from the lamp.
- Pull out the plug and fully replace the housing with LED.
- Reassemble the lamp in the reverse order.

12.9.2 Recessed light with LED

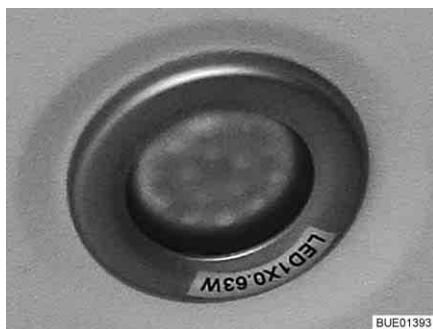

Fig. 221 Recessed light (example)



Fig. 222 Recessed light (alternative)



- ▷ LED lights have a very long life. It is not normally necessary to replace a light.

Changing bulbs: ■ Contact a dealer or service centre.

12.9.3 Spotlight with flexible arm

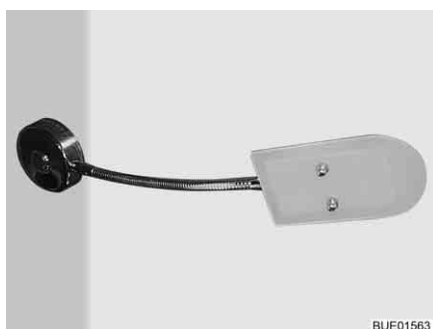

Fig. 223 Spotlight with flexible arm



- ▷ LED lights have a very long life. It is not normally necessary to replace a light.

Changing bulbs: ■ Contact a dealer or service centre.

12.9.4 Halogen spotlight (swivelling)



Fig. 224 Halogen spotlight (swivelling)

12 V/10 W halogen bulb

- Changing bulbs:*
- Turn outer ring (Fig. 224,2) in an anticlockwise direction until it separates from the housing.
 - Remove retaining ring (Fig. 224,1).
 - Remove halogen bulb.
 - Put in a new halogen bulb.
 - Reassemble the lamp in the reverse order.

12.9.5 Surface mounted light

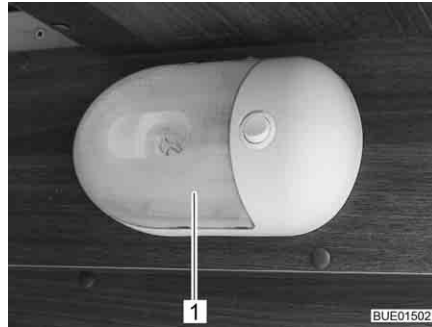

Fig. 225 Surface mounted light

12 V/16 W halogen bulb

- Changing bulbs:*
- Carefully push the transparent cover (Fig. 225,1) together from both sides, pull it lightly from the switch and pull it off forwards.
 - Remove halogen bulb.
 - Put in a new halogen bulb.
 - Reassemble the lamp in the reverse order.

12.10 Spare parts



- ▶ Every alteration of the original condition of the vehicle can alter road behaviour and jeopardize road safety.
- ▶ The special equipment and original spare parts recommended by us have been specially developed and supplied for your vehicle. These products are available at the authorised dealer or service centre. The authorised dealer or service centre is informed about admissible technical details and carries out the required work correctly.
- ▶ The use of accessories, parts and fittings not supplied by us may cause damage to the vehicle and jeopardize road safety. Even if an expert's report, a general type approval or a design certification exists, there is no guarantee for the proper quality of the product.
- ▶ No liability can be assumed for damage caused by products which have not been released by us. This also applies to impermissible alterations to the vehicle.

For safety reasons, spare parts for pieces of equipment must correspond with manufacturer's instructions and be permitted by the manufacturer as a spare part. These spare parts may only be fitted by the manufacturer or an authorised specialist workshop. The authorised dealers and service centres are available for any spare parts requirement.

Here are some suggestions of important spare parts:

- Fuses
- Bulbs
- Water pump (submerged pump)

When ordering spare parts please indicate the chassis number and the vehicle type to the dealer.

The vehicle described in this instruction manual is built and equipped to factory standards. Special equipment is offered depending on its purpose or use. When fitting special equipment check if such equipment has to be entered in the vehicle documents. Observe the max. permissible gross weight. The authorised dealer or service centre will be happy to advise you.

12.11 Vehicle identification plate

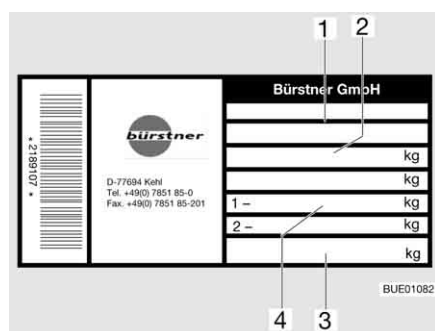

- 1 Chassis number
- 2 Maximum permissible gross weight
- 3 Permissible drawbar nose weight
- 4 Permissible axle load

Fig. 226 Vehicle identification plate

The vehicle identification plate (Fig. 226) with the chassis number is mounted on the front right side in the gas bottle compartment or on the outside of the body.

Do not remove the vehicle identification plate. The vehicle identification plate:

- Identifies the vehicle
- Helps with the procurement of spare parts
- Together with the vehicle documents identifies the vehicle owner



- ▷ Always include the **chassis number** with all inquiries for the customer service office.

12.12 Warning and information stickers

There are warning and information stickers on and inside the vehicle. Warning and information stickers are for the sake of safety and must not be removed.



- ▷ Replacement stickers can be obtained from an authorised dealer or a service centre.

Chapter overview

This chapter contains instructions regarding the tyres of the vehicle. The instructions address the following topics:

- tyre selection
- handling of tyres
- changing wheels
- spare wheel support

At the end of the chapter there is a table you can use to find the correct tyre pressure for your vehicle.

13.1 General



- ▷ Check the tyre pressure on cold tyres. Do not reduce the higher tyre pressure when the tyres are warm.
- ▷ Tubeless tyres have been installed on the vehicle. Never install tubes in these tyres.



- ▷ In the case of a puncture, pull over to the side of the road. Make vehicle and caravan safe with a hazard warning triangle. Switch on the warning lights.
- ▷ Tyres on vehicles with tandem axles may wear faster.
- ▷ Tyres should not be older than 6 years because the material will become brittle over time. Have the tyres inspected after 6 years. The four-digit DOT number on the tyre flank indicates the date of manufacture. The first two digits designate the week, the last two digits the year of manufacture.

Example: (0115) Week 01, year of manufacture 2015.

- Observe:**
- Check the tyres regularly (every 2 weeks) for equal tread wear, tread depth and external damage.
 - Replace tyres at the latest, when the minimum depth of tread stipulated by law is reached.
 - We recommend always using tyres of the same model, same brand and same version (summer and winter tyres).
 - Only use tyres approved for the wheel rim type fitted. The permitted rim and tyre sizes are quoted in the vehicle documents and the authorised dealer or service centre will always be glad to give you advice.
 - Run-in new tyres for approx. 100 km (60 miles) at low speed since only then do they reach full strength.

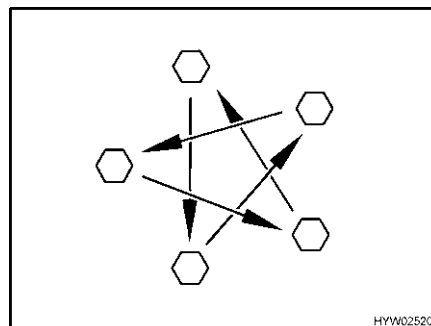

Fig. 227 Tighten the wheel nuts or wheel bolts cross-wise

- Check regularly that the wheel nuts or wheel bolts are firmly seated. Re-tighten the wheel nuts or wheel bolts of a changed wheel cross-wise (Fig. 227) after 50 km (30 miles).
See section 13.5.2 for tightening torque.
- When using new or newly painted rims, re-tighten the wheel nuts or wheel bolts once again after approx. 1,000 to 5,000 km (600 miles to 3,000 miles).
- For lay-ups or long periods of inactivity of the vehicle, keep the tyres and tyre bearings free from pressure points:
Jack up the vehicle so that the wheels do not bear any load, or move the vehicle every 4 weeks in such a way that the position of the wheels is changed.

13.2 Tyre selection



- ▶ A wrong tyre can damage the tyres during the journey and even cause it to burst.



- ▷ If tyres that are not approved for the vehicle are used, then the type approval for the vehicle and subsequently the insurance coverage can lapse. The authorised dealer or service centre will be happy to advise you.

The tyre sizes approved for the vehicle are given in the vehicle documents or can be obtained from the authorised dealers or service centres. Each tyre must fit the vehicle on which it will be driven. This applies to the external dimensions (diameter, width), which are indicated with the standardised size designations. In addition, the tyres must meet the requirements of the vehicle with regard to weight and speed.

Weight refers to the maximum permissible axle load which can be distributed on two tyres. The maximum load-carrying capacity of a tyre is indicated by its load index (= LI, load index code).

The maximum permissible speed for a tyre (with full load-carrying capacity) is indicated by the speed index (= SI). Together, load index and speed index form the operating code of a tyre. This is an official component of the complete, standardised dimensions description which appears on every tyre. The information on the tyres must correspond to the specifications which appear in the vehicle papers.

13.3 Tyre specifications

215/70 R 15C 109/107 Q
(example)

Description	Explanation
215	Tyre width in mm
70	Height-to-width proportion in percent
R	Tyre design (R = radial)
15	Rim diameter in inches
C	Commercial (transporter)
109	Load index code for single tyres
107	Load index code for twin tyres
Q	Speed index (Q = 160 km/h)

13.4 Handling of tyres

- Drive over kerbs at an obtuse angle. Otherwise the flanks of the tyres may get pinched. Driving over a kerb at a sharp angle can damage the tyre and result in it getting ruptured.
- Drive over high manhole covers at a slow speed. Otherwise the tyres may get pinched. Driving over a high manhole cover at high speed can damage the tyre and result in it getting ruptured.
- Check the shock absorbers regularly. Driving with poor shock absorbers significantly increases wear.
- Avoid block brakings. Block braking gives the tyres "brake plates" of varying strength. This reduces driving comfort. It might even make the tyres unserviceable.
- Do not clean the tyres with a high-pressure cleaner. The tyres can suffer serious damage within just a few seconds and rupture as a result.

13.5 Changing wheels

13.5.1 General instructions

The spare wheel (special equipment) is located in the gas bottle compartment or in a holder underneath the vehicle (special equipment). To change the wheel, use a commercial scissor-type or hydraulic vehicle jack or the AL-KO vehicle jack (special equipment).



- ▶ The vehicle must be on level, firm ground, secure from slipping.
- ▶ Before jacking up the vehicle firmly apply the handbrake.
- ▶ Prevent the vehicle from rolling away by blocking the opposite wheel with the wheel chocks.
- ▶ Under no circumstances jack the vehicle with the fitted supports.
- ▶ Position the vehicle jack underneath the axle, not under any circumstances on the bodywork.
- ▶ Never overload the vehicle jack. The maximum permissible load is specified on the vehicle jack's identification plate.
- ▶ Use the vehicle jack only for lifting the vehicle briefly while changing the tyre.
- ▶ No persons may be in the vehicle while it is raised.
- ▶ Whilst the vehicle is in a jacked up position, persons must not lie down under it.



- ▷ Do not damage the thread of the thread bolt or wheel bolt when changing the wheel.
- ▷ Tighten the wheel nuts or wheel bolts cross-wise (Fig. 227).
- ▷ When changing wheels (e.g. alloy wheel rims or wheels with winter tyres), use the correct wheel bolts of the correct length and shape. Otherwise the wheels may not be securely fixed or the braking system may not work correctly.
- ▷ The use of wheel rims or tyres that are not approved for the vehicle can make it less than fully roadworthy; such wheel rims or tyres must be separately inspected and approved by an accredited test centre.



- ▷ Protect the vehicle according to the national regulations, e.g. with a hazard warning triangle.
- ▷ Before changing the wheel, check the wheel rim and tyre size, the max. tyre load and the speed index on the tyres. Only use the wheel rim and tyre sizes stated in the vehicle documents.
- ▷ If different wheel nuts or wheel bolts are required for the vehicle tyres and the spare wheel, the wheel nuts or wheel bolts for the spare wheel will be supplied with the vehicle.

13.5.2 Tightening torque



- ▶ When mounting alloy wheel rims, only use the provided wheel bolts.

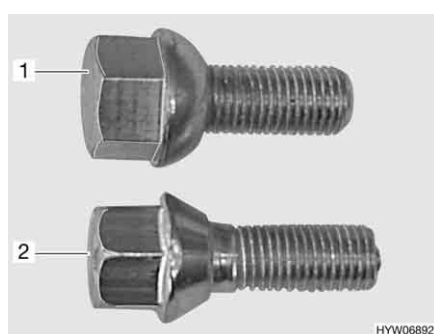

- 1 Wheel bolt - spherical
- 2 Wheel bolt - conical

Fig. 228 Wheel bolts

Rim type	Tightening torque	Type Shaft length (SL) Length (L) of wheel bolt [mm]	No. of holes/ Bolt circle/ Centre hole- Ø of rim [mm]	Width across flats
Steel 4-hole	90 Nm (67 ft/lbs)	Cone washer 60° M12x1.5 Q 8.8 Flange Ø 22 (Tol. +1.5/-0.5) SL 24 L 42 (Tol. +1/-0.5)	4/100/-	19
Steel 5-hole	90 Nm (67 ft/lbs)	Spherical R12 M12x1.5 Q 8.8 Flange Ø 24 (Tol. -2) SL 25 L 44 (Tol. +1/-0.5)	5/112/-	19
Light alloy 4-hole OJ13/4, 14/4	120 Nm (89 ft/lbs)	Cone washer 60° M12x1.5 Q 10.9 Flange Ø 21 (Tol. +0.5) SL 28 L 48 (Tol. ±0.5)	4/100/-	17

Rim type	Tightening torque	Type Shaft length (SL) Length (L) of wheel bolt [mm]	No. of holes/ Bolt circle/ Centre hole- Ø of rim [mm]	Width across flats
Light alloy 4-hole GSM1-1460-403T1	120 Nm (89 ft/lbs)	Cone washer 60° M12x1.5 Q 10.9 Flange Ø 23 SL 28 L 53.5	4/100/-	17
Light alloy 5-hole OJ14/5,15,5	120 Nm (89 ft/lbs)	Cone washer 60° M12x1.5 Q 10.9 Flange Ø 21 (Tol. +0.5) SL 28 L 48 (Tol. ±0.5)	5/112/-	17
Light alloy 5-hole GSM1-1460-512T2	120 Nm (89 ft/lbs)	Cone washer 60° M12x1.5 Q 10.9 Flange Ø 23 SL 28 L 53.5	5/112/-	17

13.5.3 Changing a wheel



- ▶ The footplate of the vehicle jack must be levelly positioned on the ground.
- ▶ Do not tilt the vehicle jack.
- ▶ Always insert the insertion profile of the AL-KO vehicle jack (special equipment) into the retention pouch as far as possible.
- ▶ If alloy wheel rims are mounted and a steel spare wheel is mounted after a puncture: Do not drive any further than necessary (car dealer, car workshop, tyre dealer). Only drive at a suitable speed. The different wheels affect driving handling.



- ▷ A special vehicle jack from AL-KO with holder pockets is available as special equipment. These holder pockets are mounted on to the frame.
- ▷ The AL-KO jack has a bearing capacity of 800 kg.
- ▷ The wheel you have replaced should be repaired immediately.
- ▷ Take note of the general instructions in this chapter.



Fig. 229 Securing support wheel



Fig. 230 Securing vehicle

Preparing the connected caravan:

- Loosen the stabilising device in caravan couplings with stabilising devices. Otherwise the friction pads will be highly loaded.
- Pull the handbrake of the towing vehicle and go to first gear or reverse gear.

Preparing the disconnected caravan:

- Park the vehicle on as even and stable a surface as possible.
- Apply the handbrake.
- Place the support wheel diagonal to the direction of travel and secure with suitable tools (Fig. 229).



Fig. 231 Commercial vehicle jack

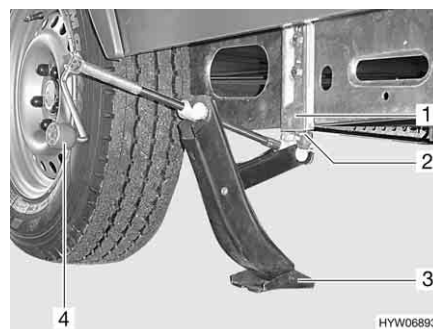

Fig. 232 AL-KO vehicle jack

Changing the wheel:

- Place chocks or other appropriate objects beneath the opposite wheel of the vehicle to secure it (Fig. 230).
- Remove the spare wheel from the spare wheel support.
- If the ground is soft, place a stable support such as a wooden board beneath the vehicle jack.
- Commercial vehicle jack:
Position the commercial scissor-type jack (Fig. 231) or hydraulic vehicle jack on the frame or on the axle.
- AL-KO vehicle jack:
Insert the insertion profile (Fig. 232,2) of the AL-KO vehicle jack into the retention pouch (Fig. 232,1) as far as possible.
- AL-KO vehicle jack:
Hold on to the AL-KO vehicle jack with one hand and with the other turn the hand crank (Fig. 232,4) in a clockwise direction until the footplate (Fig. 232,3) is touching the ground and is in a level position.
- Turn the wheel bolts several times to loosen them, but do not remove them!
- Lift the vehicle until the wheel has been lifted 2 to 3 cm above the ground.

- Remove the wheel bolts and take off the wheel.
- Place the spare wheel on the wheel hub and adjust.
- Screw in the wheel bolts and slightly tighten them cross-wise.
- Crank down the vehicle jack and remove it.
- Using the wheelbrace, tighten the wheel bolts evenly. The target value of the tightening torque of the wheel bolts is 90 Nm (67 ft/lbs) or 120 Nm (89 ft/lbs) (see section 13.5.2).

13.5.4 Changing wheels in case of alloy wheel rims



- ▶ The resting surfaces of the wheels on the break drums must be clean and free of burrs.
- ▶ Only use fastening parts provided for to loosen the wheels lightly and ensure that they rest correctly and move freely, subsequently tighten the wheel bolts cross-wise with a suitable wrench.
- ▶ Many axles do not have a centring aid, flange or bolts. It must be ensured that the wheel bolts are equally centered above the bolt circle (no jamming).
- ▶ Alloy wheel rims and steel wheel rims require different wheel bolts. If alloy wheel rims are mounted, the spare wheel (steel wheel rim) is accompanied by suitable wheel bolts.

13.6 Spare wheel support

13.6.1 Spare wheel support in gas bottle compartment

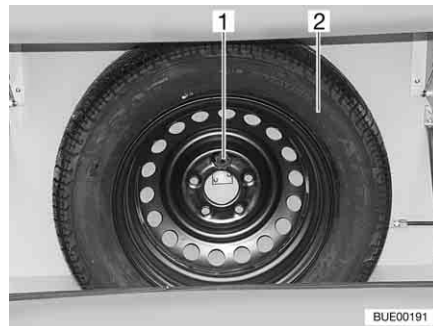

Fig. 233 Spare wheel support

The spare wheel support is fitted in the gas bottle compartment. The spare wheel (Fig. 233,2) is available for a surcharge.

Removing the spare wheel:

- Undo bolt (Fig. 233,1).
- Remove the spare wheel (Fig. 233,2).

13.6.2 Spare wheel support under the vehicle (special equipment)

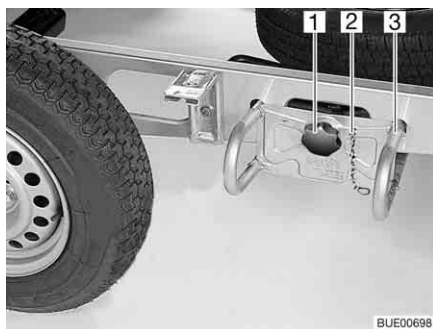

Fig. 234 Spare wheel support

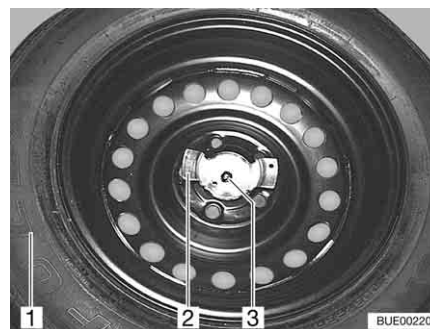

Fig. 235 Spare wheel fixture

The spare wheel support is located under the vehicle near the axle.

Removing the spare wheel:

- Unhook the safety chain (Fig. 234,2).
- Loosen and unscrew the star handle (Fig. 234,1).
- Pull out the spare wheel support (Fig. 234,3) about 10 cm and place it on the ground.
- Pull out the spare wheel support far enough that you can comfortably access the spare wheel.
- Unscrew both nuts (Fig. 235,2 and 3).
- Remove the spare wheel (Fig. 235,1) from the spare wheel support.

13.7 Tyre pressure



- ▶ Tyres overheat if the tyre pressure is too low. This can cause serious tyre damage.
- ▶ Check tyre pressure before a journey or every 2 weeks. Wrong tyre pressure causes excessive wear and can lead to damage or even to tyre burst. You can lose control of the vehicle.
- ▶ Use only valves that are approved for the specified tyre pressure.



- ▷ Check the tyre pressure on cold tyres. Do not reduce the higher tyre pressure when the tyres are warm.

The payload and the durability of tyres is directly dependent on the tyre pressure. Air is a volatile medium. It is unavoidable that it will escape from tyres.

As a rule of thumb it can be assumed that a filled tyre loses pressure at a rate of 0.1 bar every two months. To prevent the tyres becoming damaged or burst, check the tyre pressure regularly.

The contact surface of the tyre changes, depending on the tyre pressure.

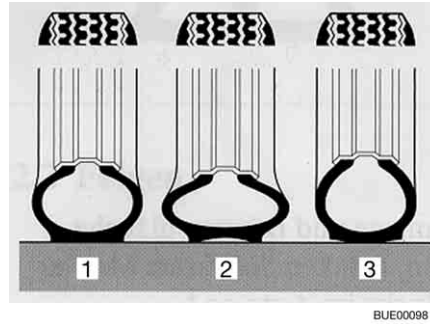

- 1 Correct tyre pressure
- 2 Tyre pressure too low
- 3 Tyre pressure too high

Fig. 236 Contact surface of the tyre



- ▷ The information on pressure levels is valid for cold tyres and loaded vehicles.
- ▷ Pressure in hot tyres must be 0.3 bar higher than in cold tyres. Recheck the pressure when the tyres are cold.
- ▷ Tyre pressures in bar.
- ▷ The tyre pressure tolerance is +/- 0.05 bar.

Tyre size	Load index (LI, minimum)	Air pressure in bar	With load in kg
185R 14 C	102	3.5	500-600
		4.0	601-700
		4.5	701-850
195R 14 C	106	4.5	750-950
195/70R 14 C/XL/RF	95	3.0	All

Maximum permissible speed of the tyre = 130 km/h (speed symbol "M").

Please always observe the speed limits in the individual countries (see chapter 17).

The vehicles are constantly brought up to the newest technical standards. It is possible that new tyre sizes are not yet included in this table. If this is the case, the Bürstner dealer will be happy to provide the newest values.



Chapter overview

This chapter contains instructions about possible faults in your vehicle. The faults are listed with their possible causes and corresponding remedies. The instructions address the following topics:

- chassis
- braking system
- caravan control system
- manoeuvring system
- electrical system
- gas system
- gas cooker
- gas oven
- microwave oven
- heater
- boiler
- hot water source
- refrigerator
- air conditioning unit
- water supply
- body

The specified faults can be remedied with relative ease and without a great deal of specialised knowledge. In the event that the remedies detailed in this instruction manual should not be successful, an authorised specialist workshop must find and eliminate the cause of the fault.

14.1 Chassis

Fault	Cause	Remedy
Coupling does not lock in place after being placed on top	Ball larger than Ø 50 mm	Remove dirt Contact customer service
	The coupling interiors are soiled and no longer work automatically	Clean well and lubricate (not stabiliser)
Caravan cannot be detached	Ball worn	Position the caravan and towing vehicle in the same direction and detach. Immediately replace the worn ball

14.2 Braking system



- ▶ Have defects on the braking system immediately remedied by an authorised specialist workshop.
- ▶ Follow maintenance or manufacturer specifications.

14.3 Caravan control system (ATC)

Fault	Cause	Remedy
Control LED flashes green (possible to continue journey)	ATC active Self test not yet complete	Drive approx. 30 m with the trailer at a minimum 10 km/h. If the control LED continues to flash, contact customer services
Control LED lights up red (possible to continue journey)	ATC not active Fault in system	Separate the electrical connection between the caravan and the towing vehicle for at least 5 seconds Reconnect If the control LED continues to light up red, contact customer services
Control LED flashes red (do not continue journey)	ATC brakes	Separate the electrical connection between the caravan and the towing vehicle for at least 5 seconds Reconnect If the control LED continues to flash red, perform a visual check in accordance with the manufacturer's instruction manual and, if necessary, reset the braking system
Control LED does not illuminate (only possible to continue journey after test)	ATC without power (only possible to continue journey after test)	Connect the electrics between the caravan and the towing vehicle
	LED defect	Connect the electrics between the caravan and the towing vehicle If the control LED still does not illuminate, perform a visual check in accordance with the manufacturer's instruction manual and contact customer service

14.4 Manoeuvring system

Fault	Cause	Remedy
Control does not react to the remote control signals	Remote control batteries empty	Change batteries
	Plug of the caravan is not inserted into the safety socket	Insert connector
	Fuse is defective	Replace fuse
	Malfunction	Perform a reset. To do so, briefly disconnect the living room battery (for approximately 10 seconds) or unplug the safety plug and then plug it back in.
Drive rollers do not turn	Battery flat	Charge the battery

14.5 Electrical system



▷ See chapter 8 for changing the fuses.

Fault	Cause	Remedy
Road light system does no longer work correctly	Bulb is defective	Unscrew cover of the relevant light, replace bulb. Note volts and watts specifications
	Contacts on the plug and/or in the socket have oxidised and/or are contaminated	Clean contacts and spray with contact spray
	Short circuit caused by water in the plug and/or socket	Open plug and/or socket, dry out, and spray with contact spray
	Cable interruption on the plug and/or socket	Open plug and/or socket, re-connect cable (see connection diagram in chapter 8)
Road light system does not match the towing vehicle light system	Contact connections within the plug have been reversed	Check contact allocation and wiring on the plug/connector of the caravan
No 230 V power supply despite connection	230 V automatic circuit breaker has triggered	Switch on 230 V automatic circuit breaker
12 V power supply in the living area does not work	230 V automatic circuit breaker switched off	Switch on 230 V automatic circuit breaker
	12 V main switch (if present) is switched off	Switch on the 12 V main switch
	Fuse on the power supply unit is defective	Replace fuse
	Power supply unit is defective	Contact customer service

Fault	Cause	Remedy
Interior lighting does no longer work correctly	Bulb is defective	Unscrew cover of the relevant light, replace bulb. Note volts and watts specifications
	LED is defective	Contact customer service
	Fuse on the power supply unit is defective	Replace the fuse on the power supply unit
No voltage from the living area battery (if there is one)	Living area battery is discharged	Charge living area battery immediately  ▷ Total discharge damages the battery. If the vehicle is to be laid up for a long period, fully charge the living area battery beforehand
Extractor hood does not work	230 V automatic circuit breaker switched off	Switch on 230 V automatic circuit breaker
	Power supply unit is defective	Contact customer service
	Fuse on the power supply unit is defective	Replace fuse
	Extractor hood defective	Contact customer service
Air conditioning unit cannot be switched on or off	230 V automatic circuit breaker has triggered	Switch on 230 V automatic circuit breaker
	Remote control battery is empty	Change remote control battery

14.6 Gas system



- ▶ In case of a defect of the gas system (gas odour, high gas consumption) there is danger of explosion! Close regulator tap on the gas bottle immediately. Open doors and windows and ventilate well.
- ▶ If the gas system is defective: Do not smoke; do not ignite any open flames, and do not operate electric switches (light switches etc.). Do not check tightness of gas-conducting parts and pipes with an open flame.
- ▶ Have the defective gas system repaired by an authorised specialist workshop.

Fault	Cause	Remedy
No gas	Gas bottle is empty	Change gas bottle
	Gas isolator tap closed	Open the gas isolator tap
	Regulator tap on the gas bottle is closed	Open regulator tap on the gas bottle
	External temperature is too low (-42 °C for propane gas, 0 °C for butane gas)	Wait for higher external temperatures
	Built-in appliance is defective	Contact customer service

14.7 Cooker

14.7.1 Gas cooker/gas oven

Fault	Cause	Remedy
Ignition fuse does not operate (flame does not burn after the control knobs are released)	Heat-up time is too short	Keep control knob pressed for approx. 15 to 20 seconds after ignition
	Ignition fuse is defective	Contact customer service
Flame extinguishes when being reduced to its minimum setting	Thermocouple sensor is incorrectly set	Correctly reset thermocouple sensor (do not bend). The sensor tip should protrude by 5 mm beyond the burner. The sensor neck should not be more than 3 mm away from the burner ring; if necessary, contact customer service

14.7.2 Microwave oven



- Only qualified personnel may repair the microwave oven. Improper repairs can cause major risks to the user.

Fault	Cause	Remedy
Microwave oven does not cut in	Fuse is defective	Replace fuse
	Door of the microwave oven is not properly closed	Remove foreign bodies stuck in the door of the microwave oven and close door properly

14.8 Heater, boiler and hot water source

In the event of a defect contact the nearest customer service workshop of the relevant appliance manufacturer. The list of addresses is enclosed with the accompanying appliance documentation. Only authorised qualified personnel may repair the appliance.

14.8.1 Truma S hot-air heater

Fault	Cause	Remedy
For heater with automatic ignition: Heater does not ignite	Battery on the automatic ignition empty	Change the battery on the automatic ignition

14.8.2 Truma boiler

Gas operation

Fault	Cause	Remedy
Red indicator lamp "Fault" illuminates	Air in the gas pipe system	Switch off and on again. After two futile ignition attempts, wait for 10 minutes before trying again
	Lack of gas	Open regulator tap and gas isolator tap
		Connect a full gas bottle
	Defect of a safety element	Contact customer service
Green indicator lamp behind knob is not lit	Fuse of the boiler is defective	Replace fuse
	Fuse in the electronic control unit has been triggered	Contact customer service
Red and green indicator lamps are not lit	No power supply	Establish the power supply
	Fuse of the boiler is defective	Replace fuse

Electrical operation

Boiler is connected to power supply but is not heated	Operating switch is switched off	Switch on the operating switch, the indicator lamp on the switch must light up
	Operating switch defective	Contact customer service
	230 V automatic circuit breaker is switched off	Switch on the 230 V automatic circuit breaker
	230 V power supply disconnected	Connect 230 V power supply
	Overtemperature fuse has triggered	Switch off boiler and switch on after approx. 5 minutes
	Heating coil of the boiler is defective	Contact customer service

14.8.3 Truma hot water source

Fault	Cause	Remedy
The hot water source is connected to power supply but does not heat	Operating switch is switched off	Switch on operating switch; the red indicator lamp must be lit
	Operating switch defective	Contact customer service
	230 V automatic circuit breaker is switched off	Switch on the 230 V automatic circuit breaker
	230 V power supply disconnected	Connect 230 V power supply
	Fuse is defective	Replace fuse
	Heating coil in the hot water source is defective	Contact customer service

14.8.4 Alde heater/boiler

▷ If a fault occurs in the system, the cause is shown on the display.

Fault	Cause	Remedy
Heater does not ignite with gas operation	Lack of gas	Open regulator tap and gas isolator tap
		Connect a full gas bottle
Heater does not ignite	Battery voltage too low	Charge battery. If the battery voltage rises above 11 V, the heater is switched on automatically
Heater does not ignite at 230 V electrical operation	No 230 V power supply	Switch on the 230 V automatic circuit breaker
		Connect the 230 V power supply
Heater switches off	Overheating	Allow the heater to cool. To reset the display, interrupt the 12 V power supply to the heater and switch it back on again
Heater running, but no heat at the convectors	Circulating pump does not work	Switch on room thermostat
		Contact customer service
Heater and circulating pump running, but no heat at the convectors	Air in the heating system	Bleed hot-water heater

14.9 Refrigerator

In the event of a defect contact the nearest customer service workshop of the relevant appliance manufacturer. The list of addresses is enclosed with the accompanying appliance documentation. Only authorised qualified personnel may repair the appliance.

14.9.1 General faults

Fault	Cause	Remedy
Refrigerator does not re- frigerate in 230 V opera- tion	No 230 V power supply	Connecting the 230 V power supply
	230 V automatic circuit breaker has triggered	Switch on the 230 V au- tomatic circuit breaker
	230 V operating voltage too low	Have the 230 V power supply checked by an au- thorised specialist work- shop
Refrigerator does not re- frigerate in 12 V opera- tion	Contacts on the plug and/or in the socket have oxidised and/or are con- taminated	Clean contacts and spray with contact spray
	Short circuit caused by water in the plug and/or socket	Open plug and/or sock- et, dry out, and spray with contact spray
	Cable interruption on the plug and/or socket	Open plug and re-con- nect cable
	Fuse for refrigerator is defective	Replace fuse
Refrigerator does not re- frigerate in gas operation	Lack of gas	Open regulator tap and gas isolator tap
		Connect a full gas bottle
	Air in the gas pipe	Repeat ignition 3 or 4 times
The desired refrigerating temperature is not achieved	Cobwebs or burnt resi- due in the burning cham- ber	Remove the ventilation grill on the outside of the vehicle and clean the burning chamber
	Incorrect setting	Set the temperature with the temperature control- ler
	Too much fresh food put into it	Set the temperature with the temperature control- ler
	Ventilation is not suffi- cient	Check ventilation grill
	Ambient temperature is too high	Remove the ventilation grills periodically
	Post evaporator heavily iced-over	Check refrigerator door for correct closing

14.9.2 Dometic





- ▷ In the event of a fault, the "Fault" indicator lamp will always light up as well and an acoustic signal will sound for about 20 seconds.

Fault	Cause	Remedy
LED "⚡" flashes	No 230 V power supply	Connect the 230 V power supply
	230 V automatic circuit breaker has triggered	Switch on the 230 V automatic circuit breaker
	230 V operating voltage too low	Have the 230 V power supply checked by an authorised specialist workshop
LED "⚡" flashes	Fuse on the transformer/rectifier is defective	Replace fuse on the transformer/rectifier
	Disconnecter relay in the transformer/rectifier is defective	Contact customer service
	12 V operating voltage too low	Have the 12 V power supply checked by an authorised specialist workshop
	No D+ signal	Contact customer service
LED "🔥" flashes ¹⁾	Lack of gas	Open regulator tap and gas isolator tap
		Connect a full gas bottle
	Cobwebs or burnt residue in the burning chamber	Remove the ventilation grill on the outside of the vehicle and clean the burning chamber
LEDs for display of the temperature range flash	Temperature sensor defective	Contact customer service
LED "⚡" and LEDs for display of the temperature range flash	230 V heater element defective	Contact customer service
LED "⚡" and LEDs for display of the temperature range flash	12 V heater element defective	Contact customer service
LED "🔥" and LEDs for display of the temperature range flash	Faulty burner or power unit	Contact customer service

¹⁾ After fixing the issue, press the illuminated button for "Fault"/"Reset".

14.9.3 Thetford

For certain faults, indicators flash on the operating panel.

Fault	Cause	Remedy
LEDs for types of energy and display of the temperature range flash	Refrigerator does not work	Switch refrigerator off and on again
		Check availability of an energy source
LED "  " and LEDs for display of the temperature range flash	No 230 V power supply	Connect the 230 V power supply
	230 V automatic circuit breaker has triggered	Switch on the 230 V automatic circuit breaker
	230 V operating voltage too low	Have the 230 V power supply checked by an authorised specialist workshop
LED "  " and LEDs for display of the temperature range flash	Fuse on the transformer/rectifier is defective	Replace fuse on the transformer/rectifier
	Disconnecter relay in the transformer/rectifier is defective	Contact customer service
	12 V operating voltage too low	Have the 12 V power supply checked by an authorised specialist workshop
	No D+ signal	Contact customer service
LED "  " and LEDs for display of the temperature range flash	Lack of gas	Open regulator tap and gas isolator tap
		Connect a full gas bottle
	Cobwebs or burnt residue in the burning chamber	Remove the ventilation grill on the outside of the vehicle and clean the burning chamber

14.10 Air conditioning unit

14.10.1 Dometic

Fault	Cause	Remedy
Air conditioning unit does not start up	No 230 V power supply	Connect the vehicle to the local power supply
	230 V automatic circuit breaker has triggered	Switch on the 230 V automatic circuit breaker
	Remote control batteries empty	Change remote control batteries
Air conditioning unit does not cool	Temperature below 16 °C	–
	Temperature has been set incorrectly	Adjust the temperature
	Thermostat defective	Contact customer service

Fault	Cause	Remedy
Air conditioning unit does not warm up	Temperature above 30 °C	–
	Temperature has been set incorrectly	Adjust the temperature
	Thermostat defective	Contact customer service
Water is entering the vehicle	Drainage holes for condensation are clogged	Clean air conditioning unit
	Seal is defective	Contact customer service
No more air circulation	Air filter clogged	Clean air filter
	Fan wheel defective	Contact customer service

14.10.2 Telair

Fault	Cause	Remedy
Air conditioning unit does not start up	No 230 V power supply	Connect 230 V power supply
	230 V automatic circuit breaker has triggered	Switch on the 230 V automatic circuit breaker
	Remote control batteries empty	Change batteries (2 x AAA)
Air conditioning unit does not cool	Room temperature is lower than the preset temperature	Reset temperature
Air conditioning unit does not heat	Room temperature is higher than the preset temperature	Reset temperature
Insufficient ventilation rating	Ventilation flaps closed	Open at least one ventilation flap
	Filter dirty	Clean the filter
Water is entering the vehicle	Drainage holes for condensation are clogged	Clean air conditioning unit

14.10.3 Truma

Fault	Cause	Remedy
Air conditioning unit does not cool	No 230 V power supply	Connect the 230 V power supply
	Fuse is defective	Check fuse and replace if necessary
	Temperature below 16 °C	–
	Temperature has been set incorrectly	Adjust the temperature
	Air filter contaminated	Replace air filter

14.11 Water supply

Fault	Cause	Remedy
Leakage water inside the vehicle	A leak has occurred	Identify leak, re-connect water pipes
No water	Water tank is empty	Replenish drinking water
	Water drain cock open	Close water drain cock
	Fuse of the water pump is defective	Replace fuse
	Water pump defective	Exchange water pump (have it exchanged)
	Water pipe snapped off	Straighten water pipe or replace
	Power pack or power supply unit defect	Contact customer service
Toilet has no flush water	Water tank is empty	Replenish drinking water
	Fuse for toilet is defective	Replace fuse
Water drains from the shower tray slowly or does not drain at all	The vehicle is not in a horizontal position	Position the vehicle horizontally
Drain on the one-hand lever mixer is clogged	Perlator calcified	Unclip the perlator, decalcify in vinegar water (only for products made from metal)
Milky water	Tank filled with dirty water	Clean water tank mechanically and chemically; then disinfect and rinse copiously with drinking water
	Residues in the water tank or water system	Clean water system mechanically and chemically; then disinfect and rinse copiously with drinking water

Fault	Cause	Remedy
Any change in the taste or odour of the water	Tank filled with dirty water	Clean water system mechanically and chemically; then disinfect and rinse copiously with drinking water
	Fuel filled into the water tank by mistake	Clean water system mechanically and chemically; then disinfect and rinse copiously with drinking water. If not successful: Contact a specialist workshop
	Microbiological deposits in the water system	Clean water system mechanically and chemically; then disinfect and rinse copiously with drinking water
Deposits in the water tank and/or water-carrying components	Water excessively long in the water tank and in water-carrying components	Clean water system mechanically and chemically; then disinfect and rinse copiously with drinking water

14.12 Body

Fault	Cause	Remedy
Flap hinges/door hinges are difficult to operate	Flap/door hinges are not sufficiently lubricated	Lubricate flap hinges/door hinges with acid-free and resin-free grease
Hinges/joints in the bathroom unit/toilet compartment are difficult to operate/make a grating noise	Hinges/joints are not sufficiently lubricated	Lubricate hinges/joints with solvent-free and acid-free grease  ▷ Spray cans often contain solvents
Storage compartment hinges are difficult to operate/make a grating noise	Storage compartment hinges are not sufficiently lubricated	Lubricate storage compartment hinges with acid-free and resin-free grease



- ▷ The authorised dealers and service centres are available for any spare parts requirement.



15.1 Weight details for special equipment



- ▶ The use of accessories, parts and fittings not supplied by us may cause damage to the vehicle and jeopardize road safety. Even if an expert's report, a general type approval or a design certification exists, there is no guarantee for the proper quality of the product.
- ▶ Every alteration of the original condition of the vehicle can alter road behaviour and jeopardize road safety.
- ▶ No liability can be assumed for damage caused by products which have not been released by us. This also applies to impermissible alterations to the vehicle.

Weight details for Bürstner special equipment are listed in the table below. If these objects are either carried in or on the vehicle and are not part of the standard equipment, they must be taken into consideration when calculating the payload.

All weight details are approximate.

Observe the max. permissible gross weight.

Item designation	Surplus weight (kg)
Waste bin - door	1
Waste water pipes, insulated and heated	7
Waste water tank 22 litres	3
Airmix comfort package	2
AL-KO Trailer-Control	6
External shower	1
Oven	15
Direct water supply	1
Skylight Heki 2	4
Drawbar covering	3
Drawbar head theft protection	2
Extractor hood	2
Shower curtain with rail	2
Conversion door, single-section with window	3
Electric kit: Battery, battery charger, panel	30
Spare wheel 185 R 14 C	20
Spare wheel 195/70 R 14	15
Spare wheel support under vehicle	1
External gas connection	1
Rear bike rack for 2 bicycles	10
Floor warming unit	7
Garage flap, front right	27
Garage flap, rear left	23
Gas bottle (11 kg) made of aluminium	11
Gas bottle switching facility, automatic	1

Item designation	Surplus weight (kg)
Holder for flat screen	3
Insect screen, door (full height)	2
Children's bunk bed with 3 levels	9
Air conditioning unit (Dometic)	35
Air conditioning unit (Telair)	34
Air conditioning unit (Truma)	26
Combination socket 230 V/12 V/TV	3
160-litre refrigerator	14
TecTower refrigerator	53
Microwave oven	14
Minisafe	5
Neck rests (round seating group)	3
Cushion for additional bed	5
Truma Mover manoeuvring system	60
Roll-up grille	20
Satellite unit	16
Service flap, front	3
Service flap, rear	2
Service flap, rear left	12
Bedsread	2
Truma electric boiler	7
Truma gas boiler	11
Truma hot water source	4
Truma Ultraheat	3
Truma circulation system	12
Truma hot air	9
Moving hot water supply forward	1
Vehicle jack (AL-KO)	5
Truma winter package	13

16.1 Table of linear measures

Type	Body length, exterior	Body length, interior	Body width, exterior	Total length	Overall height	Awning dimensions
Premio Plus 510 TK	6020	5500	2300	7390	2740	10210
Averso Top 430 TS	5140	4500	2300	6520	2580	9010
450 TS	5340	4700	2300	6690	2580	9210
460 TS	5500	4860	2300	6880	2580	9370
465 TS	5920	5280	2300	7290	2580	9800
470 TS	5890	5250	2300	7280	2580	9760
475 TL	5770	5130	2300	7140	2580	9650
485 TS	6170	5540	2030	7430	2580	10050
520 TK	6170	5540	2300	7440	2580	10050
535 TL	6070	5430	2300	7420	2580	9950
545 TS	6690	6050	2300	8070	2580	10560
560 TK	6410	5780	2500	7800	2580	10290
Nordic 580 TS	6595	-	2500	7945	2580	10460
600 TK	6695	-	2500	8085	2580	10560
650 TS	7400	-	2500	8780	2580	11280
Averso Plus 410 TS	4710	4040	2300	6050	2740	8730
440 TK	5290	4620	2300	6560	2740	9310
510 TK	6130	5460	2300	7400	2740	10150

16.2 Power supply

Input voltage	Primary	230 V AC, 47-63 Hz
Output voltage	Secondary	12 V DC, max. 24 A
Fuse	Protection class I	



Chapter overview

This chapter contains helpful tips for the journey.

The instructions address the following topics:

- road assistance in European countries
- traffic rules in European countries
- gas supply in European countries
- toll regulations in European countries
- safe ways to spend the night during travel
- camping in winter

At the end of the chapter there is a checklist containing the most important equipment for the journey.

17.1 Traffic rules in foreign countries



- ▷ The vehicle driver is required to inform himself as to the traffic rules of the countries in which he plans to travel before beginning the trip. Contact your automobile club or embassy for further information.
- ▷ In some European countries, warning vests must be worn when exiting the vehicle outside of towns in the case of vehicle failures or accidents.
- ▷ Depending on the country, different rules and regulations apply (e.g. different warning signs for rear carriers, obligation to carry breathalyzer kits, spare bulbs, high-visibility vests, size of reserve canister). The driver of the vehicle must familiarise him or herself with these rules before every journey.
- ▷ Up-to-date information can generally be found on the web pages of the national automobile associations.

Information about traffic regulations is especially important as state law applies in case of damage. For your own safety, always observe the following rules when travelling abroad:

- Carry your insurance certificate with you.
- Always register accidents with the police.
- Never sign documents that you have not read and understood completely.

17.2 Help on Europe's roads

Country	+ Emergency services ★ Police	☎ Breakdown service
Belgium	+ 112 ★ 112	☎ TCB Brussels (02) 2 33 22 11 RACB Brussels (02) 2 87 09 11
Bosnia-Herzegovina	+ 124 ★ 122	☎ BI HAMK 33 21 27 72
Bulgaria	+ 112 ★ 112	☎ UAB (02) 9 35 79 35 UAB (02) 9 11 46/146 ¹⁾
Denmark	+ 112 free of charge ★ 112 free of charge	☎ FDM 45 27 07 07

Country	+ Emergen- cy services ★ Police	☎ Breakdown service
Germany	+ 112 ★ 110	☎ ADAC Munich (01 80) 2 22 22 22 ADAC 22 22 22 ¹⁾
Estonia	+ 112 ★ 112	☎ EAK 69 79 10 0 EESTI (0) 6 97 91 88/18 88 ¹⁾
Finland	+ 112 ★ 112	☎ ATCF Helsinki (09) 77 47 64 00
France	+ 15/112 ★ 17	☎ AIT-Assistance (08 00) 08 92 22
Greece	+ 112 ★ 112	☎ ELPA (021) 06 06 88 00
Great Britain	+ 112 ★ 112	☎ AA (0 87 05) 44 88 66
Ireland	+ 112 ★ 112	☎ AA Dublin (0) 16 17 99 99
Iceland	+ 112 ★ 112	☎ F.I.B 414 99 99
Italy	+ 112 ★ 112	☎ TC1 (0 02) 8 52 61 (0 06) 4 99 81
Croatia	+ 112 ★ 112	☎ HAK (01) 6 61 19 99
Latvia	+ 112 ★ 112	☎ LAMB (0 67) 56 62 22
Lithuania	+ 112 ★ 112	☎ LAS (0 52) 10 44 33
Luxembourg	+ 112 ★ 112	☎ ACL (04) 50 04 51
Macedonia	+ 194 ★ 192	☎ AMSM (02) 3 18 11 81
Montenegro	+ 112 ★ 112	☎ AMS CG (0 20) 23 49 99
Netherlands	+ 112 ★ 112	☎ ANWB (0 88) 2 69 71 47 KNAC (0 70) 3 83 16 12
Norway	+ 113 ★ 112	☎ NAF (092) 60 85 05 KNA (0 21) 60 49 00
Austria	+ 112 ★ 112	☎ ÖAMTC (01) 71 19 90
Poland	+ 112 ★ 112	☎ PZM (0 22) 8 49 93 61
Portugal	+ 112 ★ 112	☎ ACP (02 13) 18 01 00

Country	+ Emergen- cy services ★ Police	☎ Breakdown service
Romania	+ 112 ★ 112	☎ ACR (0 21) 3 15 55 10
Russia	+ 03 ★ 02	☎ RAS (04 95) 6 29 07 07 ACAR (04 95) 9 25 50 00
Sweden	+ 112 ★ 112	☎ M Stockholm (08) 6 90 38 00
Switzerland	+ 144 ★ 112	☎ TCS (0 22) 4 17 27 27 ACS (0 31) 3 28 31 11
Serbia	+ 112 ★ 112	☎ AMSS (0 11) 3 33 11 00
Slovakia	+ 112 ★ 112	☎ SATC (02) 68 24 92 11
Slovenia	+ 112 ★ 112	☎ AMZS (01) 5 30 51 00
Spain	+ 112 ★ 112	☎ RACE 9 02 40 45 45
Czech Republic	+ 112 ★ 112	☎ UAMK (02 61) 10 41 11
Turkey	+ 112 ★ 155	☎ TTOK (02 12) 2 82 81 40
Ukraine	+ 112 ★ 112	☎ 112 UA (0 32) 2 97 01 12
Hungary	+ 112 ★ 112	☎ MAK (01) 3 45 18 00
Cyprus	+ 112 ★ 112	☎ CAA (0 22) 31 32 33

¹⁾ In the mobile communication network

Date 07/2014

Specifications without guarantee

17.3 Speed limits



▶ Please always observe the speed limits in the individual countries.



▷ Additional provisions may apply in different countries (regional regulations, regulations for newly qualified drivers, etc.).

For information, the speed limits of the countries visited most (all specifications in km/h):

Country	In built-up areas	Outside built-up areas	Motorway
Belgium	50	90/120 ^{1) 2)}	120 ²⁾
Bosnia and Herzegovina	50	80	80
Bulgaria	50	70	100
Denmark	50	70	80
Germany	50	80	80 ³⁾
Estonia	50	70	90
Finland	50	80	80
France	50	90 ⁴⁾ /110 ^{1) 2) 5)}	130 ^{6) 7)}
Greece	50	80	80
Great Britain	48	80/96	96 ⁸⁾
Ireland	50	60-80 ¹⁰⁾	80
Iceland	50	80	-
Italy	50	70	80
Croatia	50	80	90
Latvia	50	80	90
Lithuania	50	90 ^{2) 9)}	90
Luxembourg	50	75	90
Macedonia	50-60 ¹⁰⁾	80 ¹¹⁾	80
Montenegro	50	80	-
Netherlands	50	80 ²⁾	90 ²⁾
Norway	50	60 ¹²⁾ /80	60 ¹²⁾ /80
Austria	50	100 ¹³⁾	100 ¹³⁾
Poland	50	70/80 ¹⁾	80
Portugal	50	70/80 ¹⁰⁾	100
Romania	50	70/80 ¹⁾	90
Russia	60	70	90 ¹⁴⁾
Sweden	40 ^{10) 15)}	80 ¹⁵⁾	80 ¹⁵⁾
Switzerland	50	80	80
Serbia	50	80	80
Slovakia	50	80 ¹⁶⁾ /90	80 ¹⁶⁾ /90
Slovenia	50	80 ¹⁶⁾ /90-100	80 ¹⁶⁾ /100
Spain	50	70/80 ¹⁾	80
Czech Republic	50	80	80
Turkey	40	80	110
Ukraine	60	80 ¹⁴⁾	80 ¹⁴⁾
Hungary	50	70	80
Cyprus	50	65/80 ¹⁾	100

- 1) On expressways, on roads with more than one lane in each direction and on roads resembling highways
- 2) Towing vehicles with a maximum permissible gross weight less than 3.5 t
- 3) With visibilities below 50 m caused by fog, snow or rain, a speed limit of 50 km/h applies
- 4) In wet conditions 80 km/h
- 5) In wet conditions 100 km/h
- 6) In wet conditions 110 km/h
- 7) Drivers who have had their driver's licence for less than three years must not drive faster than 110 km/h
- 8) Towing vehicle/trailer combinations must not use the far left-hand lane (far right-hand lane in GB) on three-lane motorways
- 9) On non-asphalt roads 70 km/h apply
- 10) According to the traffic signs
- 11) Drivers who have had their driver's licence for less than two years must not drive faster than 60 km/h
- 12) Trailers with no brakes and a current gross weight exceeding 300 kg
- 13) With trailers weighing more than 750 kg (max. permissible gross weight 3.5 t), on highways 80 km/h, on motorways 100 km/h. For cars and trailers over 3.5 t permitted total weight, outside built-up areas 70 km/h, on motorways 80 km/h
- 14) Drivers who have had their driver's licence for less than two years must not drive faster than 70 km/h
- 15) Trailer with no brakes whose maximum permissible gross weight is two times the unladen weight of the towing vehicle: 40 km/h
- 16) Cars and trailers with a maximum permissible gross weight over 3.5 t

Date 08/2014

Source: ADAC

Specifications without guarantee

17.4 Driving with low beam in European countries



- ▷ In many European countries, it is compulsory to drive with the vehicle's lights on even during the day. Regulations vary between countries. Motoring organisations or consulates can provide you with the relevant information.

17.5 Sleeping in the vehicle away from camping areas

Country	Sleeping on roads and fields		Sleeping on privately owned lands		Comments
	Yes	No	Yes	No	
Belgium		X	X		On highway rest areas max. 24 hours permitted
Bulgaria		X		X	
Denmark		X	X		
Germany	X		X		Staying overnight for one night to restore driving ability is permitted. There may be regional and local limitations

Country	Sleeping on roads and fields		Sleeping on privately owned lands		Comments
	Yes	No	Yes	No	
Finland		X		X	Possible with the permission of the land owner
France	(X)		X		Permission from the local authorities or the owner of the land is required. Parking and staying overnight on free areas is prohibited
Greece		X		X	One-off overnight stays in designated areas are permitted
Great Britain		X	X		Regulated by local rules
Ireland		X	X		Regulated by local rules
Italy	X		X		Staying overnight for one night at car parks and service stations is allowed. Observe the local regulations. Parking and staying overnight on free areas is prohibited
Croatia		X		X	
Luxembourg		X		X	
Macedonia		X		X	
Netherlands		X		X	Overnight stays on streets and squares is allowed in some boroughs
Norway	X		X		Officially prohibited on rest areas and cultivated grounds. Driving on dirt tracks prohibited; observe local regulations
Austria		X		X	Staying overnight for one night to restore driving ability is permitted, but not in nature reserves. Observe regional and local restrictions. Generally forbidden in Tyrol
Poland		X	X		Requires property owner's permission
Portugal		X		X	Staying overnight for one night on motorway service stations and car parks under 10 hours are tolerated
Romania		X		X	
Russia		X		X	
Sweden	X		X		Not on agriculture areas or in the vicinity of houses. Driving on rough terrain prohibited; observe local regulations

Country	Sleeping on roads and fields		Sleeping on privately owned lands		Comments
	Yes	No	Yes	No	
Switzerland		X	X		One overnight stay at highway rest areas and in some cantons is tolerated
Serbia and Montenegro		X		X	
Slovakia		X	X		Overnight stays on private land are only allowed if a toilet is present
Slovenia		X		X	
Spain	X		X		Some regional prohibitions apply, especially on beaches
Czech Republic		X	X		Overnight stays on private land are only allowed if a toilet is present
Turkey	X		X		
Ukraine	X		X		
Hungary		X	X		Staying overnight on privately owned land is permitted only with police certification

Specifications without guarantee

17.6 Gas supply in European countries



- ▷ In Europe, there are several different connection systems for gas bottles. It is not always possible to fill or exchange your gas bottles in a foreign country. Get information about the connection system in the country you are travelling to before embarking on your journey, e.g. at a motoring club or in the trade press.

General tips

Always observe the following instructions:

- Only go on vacation with completely filled gas bottles.
- Use all of the gas bottles' capacity.
- Take along adapter sets (available in camping supply stores) for filling gas bottles in foreign countries and for connecting the gas pressure regulator to foreign gas bottles.
- During the cold time of the year observe filling with propane gas component (butane does not gas below 0 °C).
- Use blue bottles from the firm Campingaz (distributed world-wide). Only use gas bottles with safety valves.
- When bottles from other countries are used, check the gas bottle compartments to see if the gas bottles fit into them. Gas bottles from other countries do not always display the same size as your own gas bottles.
- The web site www.mylpg.eu provides an overview of gas suppliers in Europe.

17.7 Toll regulations in European countries

Many European countries have introduced a mandatory toll system. The toll regulations and how they are collected vary greatly from country to country. Nevertheless, ignorance is no excuse. Penalties can be quite severe.

As is the case with traffic regulations, the vehicle driver is required to be familiar with the toll formalities before starting out on a trip.

Contact your automobile club or the Internet for further information.

17.8 Tips on staying overnight safely during travel

Prudent behaviour is the most important protective measure for insuring a safe night in the caravan.

The risk of thievery is reduced to a minimum when the following basic rules are observed:

- Before commencing the journey, close and lock all windows, doors and skylights.
- During high season do not spend the night at highway rest stops or parking areas located along typical vacation routes.
- Several vehicles on one site at the same time do not necessarily decrease the chances of thievery occurring. Consult your own feelings about the parking site.
- Even if it is just for one night, go to a camping site.
- Only take with you those valuables which are absolutely necessary for the journey. If possible, store valuables in a small safe and not in the immediate vicinity of windows or doors.
- Always lock up the vehicle.

17.9 Tips for winter campers

The following tips will help make your winter camping experience as agreeable as possible.

- Reserve your parking place in good time. Good winter camping sites are often booked up early.
- Do not start your trip without winter tyres.
- Choose your parking place with care. Observe the ground beneath you. Snow and ice may melt.
- Place boards of a sufficient size under the jockey wheel and the corner steadies to prevent them from sinking when the snow thaws.
- When the vehicle has been positioned, release the handbrake to prevent freezing.
- Protect the handbrake lever and the accumulator against frost with protective covers.
- No snow walls should be allowed to cover the built-in forced ventilation.
- Protect the gas bottle compartment against freezing with a protective cover.
- Do not leave waste water in the tank but drain it into a bucket.
- Keep the built-in forced ventilation free from snow and ice.
- Make sure the air circulation is good. Good air circulation prevents moisture from collecting and makes it easier to heat the living area.
- Follow the instructions in the section "Gas supply in European countries".
- Use a two-bottle system with automatic controller for the gas system, so that the supply does not run out during the night.
- Only operate the gas system using propane gas.
- Do not use the space behind the heater as a storage compartment.

- Never operate catalytic ovens or infra-red gas radiators in the interior of the vehicle, since they consume oxygen for burning.
- Lay the 230 V power cable in such a way that the cable cannot be frozen or be damaged (e.g. during snow removal).
- Use a winter awning.
- When it is snowing heavily, clear the roof of the vehicle of snow regularly. A few centimetres of powdery snow serves as insulation, but wet snow quickly becomes a heavy burden.
- Before embarking on the return journey, remove all the snow from the roof to avoid impeding vehicles behind you with a "snow flag".

17.10 Travel checklists

The following checklists will help that nothing important is left at home although not everything on the checklists might be necessary.



- ▷ Do not leave checking of documents (e.g. vehicle papers and information) as well as checking the condition of the vehicle until just before commencing the trip. Planning and checking documents well in advance will save unnecessary trouble.

Kitchen area

✓	Object	✓	Object	✓	Object
	Wiping cloth		Cleansing agent (detergent)		Salad servers
	Silverware		Dishcloths		Chopping board
	Turnspit		Glasses		Brush to wash the dishes
	Can opener		Set of knives and forks for grilling		Cloth to wash the dishes
	Ice cube tray		Corkscrew		Matches
	Lighter		Kitchen paper		Thermos jug
	Bottle opener		Garbage bags		Pots
	Air-tight storage boxes		Frying pans		
	Crockery		Stirring spoons		

Bathroom/sanitary items

	Towels		Sanitary items		Toilet paper
	Hygiene products		Toilet brush		Toothbrush glass

Living area

	Dustbin		Deck of cards		Rucksack
	Road atlas		Broom		Sleeping bags
	Bath towels		Dust pan		Pencils and paper
	Bath shoes		Candles		Shoes
	Batteries		Coat-hangers		Shoe polish
	Bed linen		Clothes brush		Sports equipment
	Laundry bag		Pillow		Vacuum cleaner
	Books		Map		Flash light
	Camping guide / parking space directory		Medicine		Pocket knife

✓	Object	✓	Object	✓	Object
	Binoculars		Mobile phone		Table cloth
	Fire extinguisher		Sewing kit		Drinking bottle
	Gas bottle		Rain clothes		Clothes pins
	Insect lamp		First aid kit		Clothesline
	Insect repellent		Travel guide		

Vehicle/tools

	Waste water container		Gas tube		Snow chains (winter)
	Adapter socket		Fabric tape		Screwdriver
	CEE adapter		Watering can for drinking water		Current-measuring instrument
	Wire		Cable reel		Step
	Spare wheel		V-belt		Wheel chocks
	Spare lamps		Glue		First-aid kit
	Spare fuses		Universal pliers		Vehicle jack
	Replacement water pump		Compressor		Hazard warning triangle
	Hammer		Loops		Warning sign
	Flat wrench		Tube adapter		Warning vest(s)
	Gas filling adapter		Hose clips		Flashing hazard warning light

Outside

	Stay rope		Camping table		Lock
	Bellows		Luggage racks		String
	Camping chairs		Grill		Tent pegs/tightening ropes

Documents

	List of addresses		Registration book		Passport
	Registration confirmation(s)		Driving licence		Writ of protection
	Allergy certificate		Vaccination certificate		Insurance documents
	Instruction manuals		Credit card		Vignette/toll card
	Instruction leaflets for medicines		Identity card		Visa

Pos.	Component	Activity	Interval
1	Jockey wheel	Lubricate, check wheel rims for damage, visual check of the tyres, check threaded spindle and crank	Annually
2	Corner steadies	Lubrication	Annually
3	Joints, hinges and levers on the chassis	Lubrication	Annually
4	Underbody	Visual check, repair underbody protection as necessary	Annually
5	Chassis	Lubrication	Annually
6	Wheel attachment	Tighten the wheel nuts, check tyre bearings	Annually
7	Tyres and wheel rims	Air pressure check (see section 13.7). Visual check for damage, tread depth at least 2 mm	Annually
8	Brakes	Check and adjust if necessary	Annually
9	Outside lighting	Function check	Annually
10	Refrigerator, heater, kitchenette, storage flap locks, water system	Function check	Annually
11	Cushions, curtains, blinds	Visual check	Annually
12	Windows, skylights	Function check, water ingress test	Annually
13	Sealing strips, edges, rubber	Check for damage	Annually
14	Electrical system	Function check	Annually
15	Brake lining	Lining thickness min. 4 mm	Every two years
16	Brake drums	Visual check for wear and rust, check spring tension	Every two years
17	Axle bearing	Check the slack	Every two years
18	Slotted nut on the wheel	Check position and dummy fuse	Every two years
19	Overrun brake	Function check	Every two years
20	Brake cable assembly	Visual check	Every two years
21	Chassis underbody	Check bolts are firmly secured	Every two years
22	Gas system	Official gas inspection	Every two years



Delivery _____	Pos. 1-14
Stamp of the Bürstner dealer	
Date	Signature

1st year _____	Pos. 1-14
Stamp of the Bürstner dealer	
Date	Signature

2nd year _____	Pos. 1-22
Stamp of the Bürstner dealer	
Date	Signature

3rd year _____	Pos. 1-14
Stamp of the Bürstner dealer	
Date	Signature

4th year _____	Pos. 1-22
Stamp of the Bürstner dealer	
Date	Signature

5th year _____	Pos. 1-14
Stamp of the Bürstner dealer	
Date	Signature

6th year _____	Pos. 1-22
Stamp of the Bürstner dealer	
Date	Signature

7th year _____	Pos. 1-14
Stamp of the Bürstner dealer	
Date	Signature

8th year _____	Pos. 1-22
Stamp of the Bürstner dealer	
Date	Signature

12 V fuses	99
For the refrigerator	100
For Thetford toilet	100, 101
Heater for waste water pipes	101
On the power supply unit	100
12 V indicator lamp	94
12 V main switch	94
12 V power supply	88
Switching on	94
Troubleshooting	197
230 V automatic circuit breaker	102
230 V connection	40, 98
External flap	48
Troubleshooting	197
230 V fuse	102
230 V indicator lamp	93
230 V power supply	97
3-way valve	113

A

Accessories, fitting	12
Actual weight	24
Adapter, thirteen-pin plug	103
Additional equipment	25
Add-on parts see special equipment	12
Air conditioning unit (Dometic)	
Air current, adjusting	127
Care	167
LED	127
Maintenance	167
Operating modes	126
Switching off	126
Switching on	126
Troubleshooting	204
Air conditioning unit (Telair)	
Care	167
Filter, cleaning	167
Operating modes	128
Switching off	129
Switching on	128
Troubleshooting	205
Ventilation grill, cleaning	167
Air conditioning unit (Truma)	
Maintenance	168
Position	129
Remote control	129
Switching off	129

Switching on	129
Timer	130
Troubleshooting	205
Air outlet nozzles, adjustment	109
Airmix	119
Alloy wheel rims	191
Antenna alignment	41
Automatic	40
Appliances	107
Manuals	12
Warranty cards	1
ATC (caravan control system)	22
Automatic power selection (AES)	139
Awning light	180
Axle load	28

B

Basic equipment	25
Battery main switch	89
Battery see living area battery	89
Battery voltage, displaying	93
Bed widening, single beds	72
Beds	67
Before the journey	17
Bench seating group, sleeping conversion	74, 75
Bike rack	
Bicycles, loading	30
Load	29
On the front	30
On the rear wall	30
Travelling with a loaded bike rack	29
Blind, cleaning	165
Blind, Heki skylight	
Closing	63
Opening	63
Blind, window	
Closing	59
Opening	59
Boiler (Alde)	
Emptying	116
Safety instructions	109
Troubleshooting	201
Water, filling with	116
Boiler (Truma)	122
230 V electrical operation	123
Combined operation	123
Emptying	124

Gas operation	122	High-pressure cleaner, washing with	161
Operating modes	122	Hot-water heater	176
Troubleshooting	200	In the winter	168
Water, filling with	123	Insect screen	165
Brakes	35	Interior care	164
Check	35, 195	Lamps	164
Maintenance	175	Leather covers	164
Braking system, troubleshooting	195	Manoeuvring system	163
Breakaway brake cable	21	Net curtains	164
Breakdown services in Europe	213	PVC-floor covering	164
Bulbs, changing	178, 181	Roman shade	165
Ceiling lamp	181	Sink	164
Exterior lighting	178	Synthetic parts, interior	164
Front lights	179	Temporary lay-up	169
Halogen spotlight	182	Underbody	163
Interior lighting	181	Upholstery	164
Rear lights	179	Washing	162
Recessed light	182	Waste water tank	165
Spotlight	182	Water pipes	166
Surface mounted light	183	Water system	165
Types of external bulbs	180	Windows	162
Bunk bed	67	Winter lay-up	171
Butane gas	15, 80	Carpet, cleaning	164
		Ceiling lamp	181
C		Changing wheels	187
Cable reel	98	In case of alloy wheel rims	191
Camping gas bottles, use	15, 81	Tightening torque	188, 191
Camping in winter	220	Chassis number	184
Cap, drinking water filler neck	48	Chassis, troubleshooting	195
Capacity of the battery	87	Checklist	169
Caravan		Before the journey	33
Correct loading	27	For the journey	221
Pitching	37	Initial start-up after temporary lay-up	172
Caravan control system (ATC)	22	Road safety	33
Troubleshooting	196	Temporary lay-up	169
Caravan coupling	21	Winter lay-up	171
With detachable ball neck	20	Checks see checklist	33
Caravan load	24, 28	Children's beds	67, 68, 70
Care	161	Circuit diagram	
Air conditioning unit (Dometic)	167	Exterior	106
Air conditioning unit (Telair)	167	Interior	105
Blind	165	Circulating pump,	
Carpet	164	setting the rotational speed	113
Curtains	164	Cleaning	
External care	161	Waste water tank	165
Extractor hood	167	Water tank	165
Furniture surfaces	164	Cleaning see care	161
Gas cooker	164	Components, securing	32

Condensation	55
On the double acrylic glass pane	56
On the screwed connections	
in the floor	55
Condensation water see condensation	56
Connecting	20
Connecting cable see 230 V connection	98
Connection diagram, thirteen-pin plug	103
Connection to the towing vehicle	103
Connection diagram	103
Conversion door	43, 44
Roman shade, closing	44
Roman shade, opening	44
Conversion door, inside	
Locking	44
Opening	44
Conversion door, outside	
Locking	44
Opening	43
Cooker	130
Troubleshooting	199
Corner steadies	38
Cranking down	38
Cranking up	38
Curtains, cleaning	164

D

Danger of suffocation	12, 55
Detaching	23
Dimensions see table of linear measures	211
Displays, battery voltage	93
Disposal	
Household waste	8
Sewage	8
Waste water	8
Door lock	43
Doors	
Conversion door	43
Lock	43
Maintenance work	175
Troubleshooting	207
Drain cocks, position	116
Driving in reverse	36
Driving with the caravan	35
During the journey	35

E

Electric kit	89
Panel LT 408	93
Power supply unit	91
Scope	89
Electrical system	87
230 V connection, troubleshooting	197
Explanation of terms	87
Lighting, troubleshooting	197
Safety instructions	16
Troubleshooting	197
Entrance step	39
Environmental tips	8
Exterior lighting	
Bulbs, changing	178
Types of bulbs	180
External care	161
External connection see 230 V connection	40
External flaps	45
Flap lock	45, 46, 47
External gas connection	82
External mirrors	13, 31
External shower	78
Connection	78
Emptying	78
External socket	104
Extractor hood	135
Care	167
Filter, cleaning	167

F

Fault current protection switch	98, 102
Check	102
Fire	
Behaviour in the event of	11
Extinguishing	11
Fire prevention	11
Fire risks, avoidance	11
FI-switch see fault current protection switch	102
Fixed bed	67
Closing	67
Opening	67
Flap lock	
Closing	46, 47, 48
Elliptical-shaped	45
Flap for toilet cassette	47

Index

- Opening 45, 46, 47, 48
 Rectangular 47
 With recessed handle 46
 Flat screen with holder 52
 Positioning 53, 54
 Storing 53, 54
 Floor warming unit, electrical
 Overload protection 122
 Switching off 121
 Switching on 121
 Folding bed in cabinet
 Closing 71
 Opening 70
 Setting up the safety net 71
 Forced ventilation 12, 55
 Furniture flaps 49
 Closing 49, 50
 Opening 49, 50
 Furniture flaps, troubleshooting 207
 Furniture surfaces, cleaning 164
 Fuses
 12 V fuses 99
 230 V fuse 97, 102
 For the Thetford toilet 100, 101
 Heater for waste water pipes 101
 On the power supply unit 100
 Fuses see 12 V fuses and 230 V fuse 99
- G**
- Gas bottle compartment 15, 80
 Gas bottles
 Changing 81
 Safety instructions 15, 80
 Gas connection, external 82
 Gas cooker
 Cleaning 164
 Switching off 131, 132
 Switching on 131, 132
 Troubleshooting 199
 Gas isolator taps 82
 Symbols 82, 107
 Gas odour 14, 79, 198
 Gas oven 132
 Switching off 133
 Switching on 133
 Troubleshooting 199
 Gas supply in European countries 219
- Gas system 79
 Defect 14, 79, 198
 No gas 199
 Safety instructions 14, 79
 Switching automatics 83
 Troubleshooting 198
 Gas tube, check 15, 80
 General instructions 8
- H**
- Halogen spotlight 182
 Hand crank, corner steadies 38
 Handbrake 37
 Applying 12
 Releasing 37
 Handling of tyres 187
 Heat exchanger (Alde)
 Switching on 114
 Heat exchanger, heater, replacement 107
 Heater 108
 Air outlet nozzles, adjustment 109
 Battery on the automatic ignition,
 changing 118
 Heat circulation, regulating 113
 Heat exchanger, replacement 107
 Hot air distribution 109
 Initial start-up 108
 Switching off 117
 Switching on 117
 Troubleshooting 200
 Heater automatic ignition,
 changing the battery 118
 Heater for waste water pipes, fuses 101
 Heating 55
 Heating mode 55
 Heki skylight 61, 62
 Blind 63
 Closing 61, 62
 Insect screen 62, 63
 Opening 61, 62
 Roman shade 62
 Ventilation position 61, 62, 63
 Help on Europe's roads 213
 High rate of gas consumption 14, 79, 198
 High-pressure cleaner, washing with 161

Hinged window		Information stickers	184
Blind	59	Inner door, troubleshooting	207
Closing	58	Inner doors	49
Continuous ventilation	58	Insect screen door	
Insect screen	59	Closing	45
Opening	57	Opening	45
Hot air distribution	109	Insect screen, cleaning	165
Hot galvanized chassis	163	Insect screen, Heki skylight	
Hot water source	124	Closing	62, 63
Emptying	125	Opening	62, 63
Switching off	125	Insect screen, windows	
Switching on	125	Closing	59
Troubleshooting	201	Opening	59
Water, filling with	125	Inspection plan	223
Hot-air heater		Inspection work	173
Battery on the automatic ignition,		Inspections	173
changing	118	Installation diagram	103
Switching off	117	Interior care	164
Switching on	117	Interior lighting	
Troubleshooting	200	Bulbs, changing	181
Hot-water heater		Troubleshooting	198
230 V electrical operation, selecting	112		
3-way valve	113	K	
Adjustment menu	111	Keys	17
Auxiliary circulating pump	115		
Care	176	L	
Fluid level, checking	176	Lamps	181
Gas and 230 V electrical operation,		Cleaning	164
selecting	112	Lay-up	
Gas operation, selecting	112	Temporary	169
Heat exchanger	114	Winter lay-up	171
Heater, switching off	112	Leakage water inside the vehicle	206
Heater, switching on	112	Leather covers, cleaning	164
Heating fluid, topping up	177	Lift-off table	66
Heating system, bleeding	177	Conversion to bed foundation	66
Maintenance work	176	Conversion to round seating group	66
Operating modes	112	Light switch	
Operating unit	110	Living area	51
Rotational speed, circulating pump	113	Recessed light	52
Safety instructions	109	Lighting	
Start screen	111	Front	179
Tool menus	112	Lamps, cleaning	164
Troubleshooting	201	Rear	179
		Troubleshooting	197
I		Living area battery	89
Indicator lamp, 12 V power supply	94	Changing the battery	91
Indicator lamp, 230 V power supply	93	Charging	90
Indicator lamp, toilet	159	Discharging	90
Indicator lamp, water pump	94		

Index

Instructions	89
Troubleshooting	198
Voltage, displaying	93
Load	27
Bike rack	29
Load see also payload	27
Lock	
Conversion door	43
External flap	45, 46, 47
Furniture flap	49
Low beam	217

M

Maintenance	173
Maintenance work	173
Air conditioning unit (Dometic)	167
Air conditioning unit (Telair)	167
Air conditioning unit (Truma)	168
AKS 1300	174
AKS 3004	174
Braking system	175
Doors	175
Hot-water heater	176
Manoeuvring system	175
Manoeuvring system	
Care	163
Cleaning	163
Lubricating	163
Maintenance work	175
Manoeuvring	19
Operation	18
Remote control	18
Troubleshooting	197
Marker light	180
Mass in ready-to-drive condition	25, 26
Maximum permissible gross weight	24, 26
Maximum permissible speed	215
Maximum speed, technically permissible	215
Microwave oven	
Switching off	134
Switching on	134
Troubleshooting	199
Minimum nose weight	24
Mover see manoeuvring system	18

N

Net curtains, cleaning	164
Nose weight	20, 24, 28

O

Operating modes, air conditioning unit (Dometic)	126
Operating modes, air conditioning unit (Telair)	128
Operating modes, boiler (Truma)	122
Operating modes, hot-water heater	112
Operating modes, refrigerator (Dometic)	137, 139
Operating modes, refrigerator (Thetford)	143, 145
Oven see gas cooker or gas oven	130, 132
Overrun brake	20

P

Panel LT 408	93
Panel see also displays	93
Payload	24
Calculation	26
Composition	25
Example calculation	25, 26
Payload see also load	24
People in the caravan	13, 35
Permissible gross weight see maximum permissible gross weight	24
Personal equipment	25
Power supply	211
Power supply unit CSV 300	
Functions	88
Position	88
Power supply unit CSV 409	
Battery selector switch	92
Charging the battery	92
Functions	91
Fuses	100
Position	92
Propane gas	15, 80
Pull-down bed	68
Access ladder	70
Lifting	69
Lowering	68
Retaining belts, tightening	69
PVC-floor covering, cleaning	164

R

Rear axle load	20
Recessed light	182
Refrigerator	40, 135
12 V operation, switching off	145
12 V operation, switching on	145
12 V operation, switching on/off	139
230 V operation, switching off	145
230 V operation, switching on	144
230 V operation, switching on/off	139
Anti-condensation	148
Change-over between energy sources	141, 147
Door lock	148
Frame heater	141
Fuse	100
Gas operation, switching off	138, 144
Gas operation, switching on	138, 144
Operating modes	137, 139, 143, 145
Operation	142
Refrigerating temperature control	141, 147
Select operating modes	147
Switching off	142
Switching on	142
Troubleshooting	202
Ventilation grill, removal	135
Refrigerator door	
Closing	150
Locking in the ventilation position	150
Opening	150
Refrigerator door locking mechanism	
Closing	148, 149
Locking in the ventilation position	149
Opening	148, 149
Refrigerator ventilation grill, removal	135
Registration	17
Remote control, air conditioning unit (Truma)	129
Risk of frost damage	16, 151, 155
Road safety	33
Checklist	33
Notes for	13
Roman shade, cleaning	165
Roman shade, Heki skylight	
Closing	62
Opening	62

Roman shade, window of conversion door	
Closing	44
Opening	44
Round seating group, sleeping conversion	65, 66, 76, 77

S

Safety cut-out	102
Safety instructions	11
Changing wheels	187
Cooker	130
Electrical system	16
Fire prevention	11
Gas bottles	80
Gas system	14, 79
Heater	109
Road safety	13
Towing	14
Water system	16
Safety knob, hinged window	57
Safety net, pull-down bed	69
Sanitary fittings	151
SAT socket	104
Satellite mouse	41
Satellite unit	40, 41
Satellite mouse	41
With automatic antenna alignment	40, 41
Seating groups, sleeping conversion	72
Sewage tank	
Emptying	160
Removing	160
Retaining clip	160
Shower	157
Shower connection point, external shower	78
Side marker light	180
Single beds, bed widening	72
Sink, cleaning	164
Skylights	60
Sleeping conversion	72
Bench seating group	74, 75
Round seating group	76, 77
Widening single beds	72
Sockets	
External socket	104
SAT socket	104
TV socket	104
Spare parts	183
Spare wheel	191, 192
Spare wheel support	191, 192

Special equipment	209	Thirteen-pin plug, connection diagram	103
Description	7	Tightening torque, wheels	188, 191
Marking	7	Tips	213
Safety instructions	12	Toilet	
Weight details	209	Fuse	100, 101
Speed limits	215	Preparing	158
Spotlight	52, 182	Toilet compartment	157
Turning	52	Ventilation	157
Stabiliser		Toilet see also Thetford toilet	157
AKS 1300	21	Toll regulations in European countries	220
AKS 1300, maintenance work	174	Towing	14
AKS 3004	22	Safety instructions	14
AKS 3004, maintenance work	174	Traffic rules in foreign countries	213
Stabiliser see also caravan coupling	21, 174	Travel checklists	221
Stabilising lever	20	Travel cots suitable for children	67, 68, 70
Start-up		Troubleshooting	195
After temporary lay-up	172	12 V power supply	197
After winter lay-up	172	230 V connection	197
Staying overnight		Air conditioning unit	198
Away from camping areas	217	Air conditioning unit (Dometic)	204
During travel	220	Air conditioning unit (Telair)	205
Supports see corner steadies	38	Air conditioning unit (Truma)	205
Surface mounted light	183	Body	207
Suspension table	64, 65, 66	Boiler (Alde)	201
Conversion to bed foundation	64	Boiler (Truma)	200
Conversion to round seating group	65, 66	Braking system	195
Switching automatics, gas system	83	Caravan control system (ATC)	196
Swivel table	64, 65	Chassis	195
Conversion to bed foundation	64	Cooker	199
Conversion to round seating group	65	Electrical system	197
Symbols		Extractor hood	198
For instructions	7	Furniture flaps	207
Gas isolator taps	82, 107	Gas cooker	199
Synthetic parts in the toilet		Gas oven	199
and living areas, cleaning	164	Gas system	198
		Heater	200
		Hot water source	201
		Hot-air heater	200
		Hot-water heater	201
		Inner door	207
		Lighting	197
		Manoeuvring system	197
		Microwave oven	199
		Refrigerator	202
		Thetford toilet	206
		Water supply	206
		TV socket	104
		Tyre change see changing wheels	187
		Tyre specifications	186

T

Table of linear measures	211
Table, securing	32
Tables	64
Technical data	
Dimensions	211
Power supply	211
Television	31
Thermal cut-out	89
Thetford toilet	157
Flushing	159
Indicator lamp	159
Troubleshooting	206

Tyres	185	Water system	152
Excessive wear	13, 33, 192	Care	165
General instructions	185	Cleaning	165
Handling	187	Disinfecting	166
Identification	186	Emptying	155
Load-carrying capacity	188	Filling	154
Tyre pressure	192	Safety instructions	16
Tyre selection	186	Water tank	
		Cleaning	165
		Emptying	152, 153
		Filling	152, 153
		Water, removing	152, 153
		Water tank 22 l	152
		Water tank 25 l	153
		Water tank 40 l	153
		Weight details for special equipment	209
		Wheel chocks	37
		Wheel rim size	188
		Wheel rim type	185
		Wheels	185
		Window, conversion door	
		Roman shade, closing	44
		Roman shade, opening	44
		Windows	56
		Blind	59
		Cleaning	162
		Insect screen	59
		Winter care	168
		Winter operation	169
U			
Ultraheat additional electric heater	119		
Switching off	120		
Switching on	120		
Underbody, maintenance	163		
Upholstery, cleaning	164		
V			
Vehicle identification plate	184		
Vehicle jack	7, 190		
Vehicle lighting see exterior lighting	178		
Vehicle, washing	162		
Ventilation	55		
Toilet compartment	157		
W			
Warming unit of waste water pipes	156		
Warning stickers	184		
Warranty cards	1		
Washing with a high-pressure cleaner	161		
Waste gas vent on the right hand side of the vehicle.	108		
Waste gas vent, cap	122		
Waste water installation	156		
Waste water pipes, warming unit	156		
Waste water tank	39, 156		
Care	165		
Cleaning	165		
Emptying	156		
Water pipes, cleaning	166		
Water pump	151, 154		
Indicator lamp	94		
Switch	94		
Water supply			
General	151		
Troubleshooting	206		

