

BÜRSTNER

---

# Instruction Manual



- ✓ Nexxo Van
- ✓ Lineo T
- ✓ Delfin
- ✓ Limited T
- ✓ Lyseo TD



## Dear Reader ...

We would like to congratulate you on the purchase of your new motorhome. You have selected a top-quality vehicle which will afford you many years of enjoyment.

To enable you to always use and operate your motorhome properly and easily, your Bürstner dealer will first provide you detailed instructions for all important functions when you take delivery.

This manual, the instruction manuals from the base vehicle manufacturer as well as the instruction manuals from the appliance manufacturer will always be at hand to answer any questions you may have regarding your motorhome.

## Before your first journey

Please familiarise yourself with this manual rather than relying on it strictly for reference.

Fill in the warranty cards for the appliances and optional equipment in the individual instructions and send these cards to the respective manufacturers. This ensures your warranty claim for each appliance.

Please also observe the chassis manufacturer's operating instructions at all times.

The terms used in these operating instructions with regard to weight specifications are explained again in detail at the end of the operating instructions (legal information on weight-related specifications). For further details on weight specifications, please also refer to the "Weight information" section of our homepage at [www.buerstner.com/de/en/weight-information](http://www.buerstner.com/de/en/weight-information)



<b>1</b>	<b>Introduction.....</b>	<b>9</b>	<b>5</b>	<b>During the journey.....</b>	<b>49</b>
1.1	General .....	10	5.1	Driving .....	49
1.2	Environmental tips .....	10	5.2	Reversing camera (optional equipment).....	50
<b>2</b>	<b>Weatherproof guarantee .....</b>	<b>13</b>	5.3	Driving speed .....	50
2.1	Bürstner Warranty Conditions .....	13	5.4	Brakes .....	51
2.2	Proof of water ingress tests .....	15	5.5	Seat belts.....	51
2.2.1	Vehicle data .....	15	5.5.1	General .....	51
2.2.2	Water ingress test (certificates) .....	16	5.5.2	Fastening the seat belts correctly .....	51
<b>3</b>	<b>Safety .....</b>	<b>17</b>	5.6	Child restraint systems .....	52
3.1	Fire prevention.....	17	5.7	ISOFIX child safety seat mounting system (optional equipment) .....	54
3.1.1	Avoidance of fire risks .....	17	5.8	Pilot seats for the driver's and front passenger's seats .....	55
3.1.2	Fire-fighting .....	17	5.9	Additional seat with folding table (depending on model) (optional equipment).....	55
3.1.3	In case of fire .....	17	5.10	Additional seat secured by belts (partially optional equipment).....	56
3.2	General .....	18	5.11	Seat heater (optional equipment) .....	58
3.3	Road safety.....	19	5.12	Headrests .....	58
3.4	Towing .....	20	5.13	Seating arrangement.....	59
3.5	Gas system .....	20	5.14	Roman shade in the driver's cabin.....	59
3.5.1	General instructions .....	20	5.14.1	Pleated Roman shades .....	59
3.5.2	Gas bottles .....	22	5.14.2	Roman shades, Remis (partially optional equipment).....	60
3.6	Electrical system .....	23	5.15	Refuelling.....	60
3.7	Water system .....	23	5.16	Topping up AdBlue® .....	61
<b>4</b>	<b>Before the journey.....</b>	<b>25</b>	<b>6</b>	<b>Setting up the vehicle .....</b>	<b>63</b>
4.1	Keys.....	25	6.1	Handbrake.....	63
4.2	Registration.....	25	6.2	Entrance step.....	63
4.3	Vehicle load capacity.....	25	6.3	Ramps .....	63
4.3.1	Terms .....	26	6.4	Wheel chocks .....	63
4.3.2	Calculating the vehicle load capacity.....	30	6.5	Supports.....	64
4.3.3	Load securing and load distribution .....	31	6.5.1	General instructions.....	64
4.3.4	Rear garage / rear storage space.....	35	6.5.2	Steady legs, rear (AL-KO) (optional equipment).....	64
4.4	Bike rack (optional equipment).....	36	6.6	230 V connection.....	65
4.5	Towing .....	38	6.7	Refrigerator.....	65
4.6	Caravan coupling (optional equipment).....	39	6.8	Satellite unit (optional equipment) .....	65
4.7	Electrically operated entrance step (partially optional equipment).....	40	6.8.1	Satellite unit with automatic antenna alignment (Teleco) .....	66
4.8	Door sill (special equipment).....	41	6.8.2	Satellite unit with automatic antenna alignment (Oyster Premium) .....	67
4.9	TV unit (optional equipment).....	41	6.9	Awning (optional equipment).....	69
4.10	Sink and drain basic covers (partially optional equipment) .....	42			
4.11	Kitchen extension board (depending on model) .....	42			
4.12	Securing add-on parts .....	43			
4.13	Gas regulator.....	45			
4.14	Snow chains (optional equipment).....	46			
4.15	Road safety.....	46			

# Contents

<b>7</b>	<b>Living</b> .....	<b>71</b>			
7.1	Doors.....	71	7.12	Tables.....	102
7.1.1	Central locking system, driver's cabin and conversion door (optional equipment).....	71	7.12.1	Fixed table.....	102
7.1.2	Conversion door, outside.....	72	7.12.2	Suspension table.....	103
7.1.3	Conversion door, inside.....	73	7.12.3	Lift-off table.....	105
7.1.4	Window conversion door (partially optional equipment).....	73	7.12.4	Lift-off table, divisible.....	106
7.1.5	Folding insect screen on the conversion door (partially optional equipment).....	74	7.12.5	Coffee table (dependent on model)....	107
7.2	External flaps.....	74	7.12.6	Suspension table with fold-out leg.....	107
7.2.1	Flap lock with recessed handle.....	75	7.13	Beds.....	109
7.2.2	Garage flap emergency release.....	75	7.13.1	Fixed bed (gas-pressure springs).....	109
7.2.3	Flap lock with push button.....	76	7.13.2	Fixed bed (adjustable head section)....	109
7.2.4	Service unit flap lock.....	77	7.13.3	Fixed bed, height-adjustable via strap system (optional equipment)....	110
7.2.5	Flap lock, square.....	77	7.13.4	Pull-down bed, electrically operated.....	111
7.3	Furniture flaps.....	78	7.13.5	Pull-down bed at the rear, electrically operated (Lyseo TD) (optional equipment).....	114
7.3.1	Furniture flaps with push button.....	78	7.13.6	Queen size bed, extendable in length (dependent on model).....	116
7.3.2	Furniture flaps with handle and release.....	78	7.14	Converting seating groups for sleeping.....	117
7.4	Floor compartment cover.....	79	7.14.1	Conversion of semi-dinette into guest bed (Limited T/IT 690, Lineo T 700 (H)).....	118
7.5	Rotating seats.....	79	7.14.2	Conversion of L-seating group into transverse bed (with additional cushion table) (Lyseo TD T/IT 690 L-SG, 744 L-SG).....	119
7.6	Light switch.....	80	7.14.3	Conversion of semi-dinette into transverse bed (with additional cushion and bed widening) (Lyseo TD T/IT 690 Dinette, 744 Dinette).....	119
7.6.1	Entrance area.....	80	7.14.4	Conversion of facing seating unit into transverse bed (Limited T T/IT 727, Lyseo TD IT 684, T/IT 727, 732, 736).....	120
7.6.2	Interior.....	80	7.14.5	Conversion of round seating group to transverse bed (Lyseo TD IT 644).....	120
7.6.3	Light control (optional equipment).....	82	7.14.6	Conversion of dinette into transverse bed (individual bench with lateral seat, suspension table) (Limited T T/IT 660 Dinette).....	121
7.6.4	Wardrobe light (partially optional equipment).....	82	7.14.7	Conversion of L-seating group with lateral seat into transverse bed (lift-off table) (Limited T T/IT 660 L-SG)....	122
7.6.5	Tube lamp in the rear garage.....	83	7.14.8	Conversion of dinette into transverse bed (Delfin T 726) (individual bench with lateral seat, suspension table) (Limited T T/IT 726 Dinette).....	123
7.7	Spotlight.....	83	7.14.9	Conversion of L-seating group with lateral seat into transverse bed (lift-off table) (Limited T T/IT 726 L-SG)....	124
7.7.1	Mobile lamp (optional equipment).....	84			
7.8	Holder for flat screen.....	85			
7.8.1	Holder with two-piece jointed arm.....	86			
7.8.2	Wall holder.....	86			
7.8.3	Holder with release lever.....	87			
7.8.4	Holder with pull-out.....	87			
7.9	Ventilation.....	88			
7.10	Windows.....	89			
7.10.1	Hinged window.....	90			
7.10.2	Sliding window with pressure lock.....	92			
7.10.3	Blind and insect screen.....	92			
7.10.4	Roman shade and insect screen.....	93			
7.10.5	Roman shades for windscreen, driver's window and front passenger's window.....	94			
7.10.6	Vario blind.....	95			
7.11	Skylights.....	96			
7.11.1	Skylight with snap latch.....	97			
7.11.2	Heki skylight (partially optional equipment).....	98			
7.11.3	Sunroof skylight (partially optional equipment).....	99			

7.14.10	Conversion of dinette into transverse bed (individual bench with lateral seat, lift-off table) (Lineo T 620, T 690) .....	124	9.8	Solar installation (optional equipment).....	151
7.14.11	Conversion of facing seating unit into transverse bed (lift-off table) (Lyseo TD IT 594) .....	125	9.9	230 V power supply .....	152
7.14.12	Lying surface of single beds .....	126	9.9.1	230 V connection (CEE socket outlet) .....	152
7.14.13	Lying surface of single beds (variant) .....	126	9.9.2	Connecting the 230 V power supply.....	153
7.15	Rear bed fall out protection .....	127	9.10	Fuses.....	155
7.16	Shower connection point for external shower (optional equipment).....	127	9.10.1	12 V fuses.....	155
			9.10.2	230 V fuse.....	159
<b>8</b>	<b>Gas system.....</b>	<b>129</b>	9.11	External socket (optional equipment).....	160
8.1	General .....	129	9.12	Circuit diagrams.....	161
8.2	Gas bottles.....	130	9.12.1	Circuit diagram, interior (EBL 119/EBL 99).....	161
8.3	Gas isolator taps .....	132	9.12.2	Connection diagram, panel (LT 96).....	162
8.4	External gas connection (optional equipment).....	133	9.12.3	Circuit diagram, exterior.....	163
8.5	Gas bottle switching facility (optional equipment) .....	134	<b>10</b>	<b>Appliances.....</b>	<b>165</b>
8.6	Changing gas bottles .....	137	10.1	General .....	165
<b>9</b>	<b>Electrical system.....</b>	<b>139</b>	10.2	Heater and boiler .....	166
9.1	General safety instructions .....	139	10.2.1	To heat properly .....	167
9.2	Terms .....	139	10.2.2	Hot-air heater and boiler with CP plus digital operating unit .....	167
9.3	USB socket (partially optional equipment).....	140	10.2.3	Alde hot-water heater and boiler Alde Compact 3030 (optional equipment).....	173
9.4	12 V power supply .....	141	10.2.4	Wall flue .....	178
9.4.1	Starter battery.....	141	10.2.5	Electrical floor warming unit (optional equipment) .....	179
9.4.2	Living area battery .....	142	10.3	Telair air conditioning unit (optional equipment).....	180
9.4.3	Charging batteries via a 230 V power supply .....	143	10.4	Cooker .....	181
9.4.4	Charging batteries via the vehicle engine (alternator) .....	144	10.4.1	Gas cooker .....	181
9.5	Charging booster for the living area battery .....	144	10.4.2	Cooker with gas oven and grill.....	183
9.6	Transformer/rectifier (EBL 119/EBL 99).....	145	10.4.3	Microwave oven (optional equipment).....	185
9.6.1	Battery cut-off switch.....	146	10.4.4	Extractor hood (optional equipment).....	186
9.6.2	Battery selector switch.....	147	10.5	Refrigerator.....	187
9.6.3	Battery monitor.....	147	10.5.1	Refrigerator ventilation grill .....	187
9.6.4	Charging the battery.....	147	10.5.2	Dometic Automatic (series 10) .....	189
9.7	Panel LT 96.....	148	10.5.3	Thetford, series N4000.....	192
9.7.1	Button for 12 V power supply .....	148	10.5.4	Thetford T2000 .....	195
9.7.2	V/tank gauge for battery voltage and water or waste water levels.....	149	10.5.5	Dellcool (compressor).....	196
9.7.3	Button for water pump .....	150	10.5.6	Refrigerator door locking mechanism.....	198
9.7.4	Battery alarm for the living area battery .....	150	<b>11</b>	<b>Sanitary fittings.....</b>	<b>201</b>
9.7.5	12 V indicator lamp .....	150	11.1	Water supply, general .....	201
9.7.6	230 V indicator lamp .....	151	11.2	Water system .....	202
			11.2.1	Water tank.....	202
			11.2.2	Drinking water filler neck with cap .....	202
			11.2.3	Filling the water system .....	203
			11.2.4	Topping up the water .....	205

# Contents

---

11.2.5	Closing/opening the overflow.....	205	13.7	Alde hot-water heater.....	231
11.2.6	Draining water (rotary handle with overflow).....	206	13.7.1	Checking the fluid level.....	232
11.2.7	Emptying the water system.....	206	13.7.2	Topping up heating fluid.....	232
11.3	Waste water installation.....	208	13.7.3	Bleeding the heating system.....	233
11.3.1	Draining waste water.....	208	13.8	Replacing bulbs, external.....	233
11.3.2	Heater for waste water tank and waste water pipes (optional equipment).....	209	13.8.1	Front lights.....	234
11.4	Toilet compartment.....	210	13.8.2	Rear lights (variant 1).....	235
11.5	Toilet.....	211	13.8.3	Rear lights (variant 2).....	235
11.5.1	Preparing toilet.....	211	13.8.4	Side lights.....	236
11.5.2	Swivel toilet.....	213	13.8.5	Types of bulbs for exterior lighting.....	236
11.5.3	Toilet with fixed seat.....	214	13.9	Replacing bulbs, internal.....	237
11.5.4	Emptying the sewage tank.....	215	13.9.1	Ceiling lamp.....	237
11.5.5	Odour transformer for toilet compartment (optional equipment)....	216	13.9.2	Surface mounted light.....	238
<b>12</b>	<b>Care.....</b>	<b>217</b>	13.10	Spare parts.....	239
12.1	External care.....	217	13.11	Vehicle identification plate.....	240
12.1.1	Washing with a high-pressure cleaner.....	217	13.12	Warning and information stickers.....	240
12.1.2	Washing the vehicle.....	218	<b>14</b>	<b>Wheels and tyres.....</b>	<b>241</b>
12.1.3	Windows of acrylic glass.....	218	14.1	General.....	241
12.1.4	Entrance step.....	218	14.2	Tyre selection.....	242
12.2	Interior care.....	219	14.3	Tyre specifications.....	243
12.2.1	Scratch-resistant surface (kitchen worktop and table top) (optional equipment).....	220	14.4	Handling of tyres.....	243
12.3	Water system.....	221	14.5	Changing wheels.....	243
12.3.1	Cleaning the water tank.....	221	14.5.1	General instructions.....	243
12.3.2	Cleaning the water pipes.....	221	14.5.2	Tightening torque.....	245
12.3.3	Disinfecting the water system.....	222	14.5.3	Changing a wheel.....	246
12.3.4	Cleaning the waste water tank.....	223	14.6	Tyre pressure.....	247
12.4	Extractor hood.....	223	<b>15</b>	<b>Troubleshooting.....</b>	<b>249</b>
12.5	Air conditioning unit Telair.....	224	15.1	Braking system.....	249
12.6	Winter care.....	224	15.2	Satellite unit.....	249
12.6.1	Preparations.....	224	15.3	Electrical system.....	250
12.6.2	Winter operation.....	225	15.4	Gas system.....	253
12.6.3	At the end of the winter season.....	225	15.5	Heater/boiler.....	253
12.7	Lay-up.....	225	15.5.1	Heater/boiler with CP plus digital operating unit.....	253
12.7.1	Temporary lay-up.....	225	15.5.2	Alde heater/boiler.....	255
12.7.2	Lay-up over winter.....	227	15.6	Air conditioning unit Telair.....	256
12.7.3	Starting up the vehicle after a temporary lay-up or after lay-up over winter.....	228	15.7	Cooker.....	256
<b>13</b>	<b>Maintenance.....</b>	<b>229</b>	15.7.1	Gas cooker.....	256
13.1	Official inspections.....	229	15.8	Extractor hood.....	257
13.2	Inspection work.....	230	15.9	Microwave oven.....	257
13.3	Maintenance work.....	230	15.10	Refrigerator.....	258
13.4	Doors.....	230	15.10.1	General.....	258
13.5	Living area battery.....	231	15.10.2	Dometic 10 series.....	259
13.6	Extractor hood.....	231	15.10.3	Thetford N4000.....	261
			15.10.4	Thetford T2000.....	262
			15.10.5	Dellcool.....	263
			15.11	Water supply.....	264
			15.12	Body.....	266
			<b>16</b>	<b>Optional equipment.....</b>	<b>267</b>
			16.1	Weight details for optional equipment.....	267



<b>17</b>	<b>Technical data.....</b>	<b>269</b>
17.1	View of ground plans .....	269
17.2	Table of linear measures / sleeping places .....	275
<b>18</b>	<b>Helpful notes .....</b>	<b>277</b>
18.1	Traffic rules in foreign countries .....	277
18.2	Help on Europe's roads.....	277
18.3	Gas supply in European countries.....	278
18.4	Toll regulations in European countries .....	278
18.5	Tips on staying overnight safely during travel.....	279
18.6	Tips for winter campers .....	279
18.7	Travel checklists .....	280
<b>19</b>	<b>Inspection plan.....</b>	<b>283</b>
<b>20</b>	<b>Legal notes on weight- related information.....</b>	<b>285</b>

# Contents

---

## Please read this instruction manual completely before using the vehicle for the first time!

Always keep this instruction manual in the vehicle. Also inform all other users of the safety regulations.



- ▶ The non-observance of this symbol can lead to personal injury.



- ▷ The non-observance of this symbol can lead to damage being caused to, or inside the vehicle.



- ▷ This symbol indicates recommendations or special aspects.



- ▷ This symbol indicates actions which lead to environmental awareness.

**This instruction manual contains sections which describe model-specific equipment or optional equipment. These sections are specially marked. It may be that your vehicle has not been fitted with this optional equipment. In some cases, the actual equipment of your vehicle may therefore be different from that shown in some illustrations and descriptions.**

However, your vehicle may be fitted with other optional equipment not described in this instruction manual.

Optional equipment is described when an explanation is required.

Adhere to the instruction manuals which are separately enclosed.



- ▷ The details "right", "left", "front" and "rear" always refer to the vehicle in direction of travel.

- ▷ All dimensions and weight details are "approximate".

Should the vehicle be subjected to damage due to a failure to follow the instructions in this instruction manual, then the guarantee claim is deemed invalid.

Our vehicles are subjected to continuous development. Please understand that we reserve the right to alter the form, equipment and technology.

Therefore, no claims can be made against the manufacturer as a result of the contents of this instruction manual. The equipment which was known and included at the time of going to press is described.

The reprinting, translation and copying, including extracts is not permitted without prior written authorisation from the manufacturer.

## 1.1 General

The vehicle is constructed in accordance with the latest technology and the recognised safety regulations. Nevertheless, personal injury may result and the vehicle may be damaged if the safety instructions in this instruction manual are not followed.

Before using the vehicle for the first time, equip it with the legally prescribed equipment (e.g. first aid kit, warning vest, hazard warning triangle etc.). Observe the relevant equipment regulations when travelling abroad.

Only use the vehicle in a technically impeccable condition. Follow the instructions in the instruction manual.

Malfunctions which impair the safety of persons or the vehicle should be immediately remedied by qualified personnel. To avoid further damages, observe the duty to avert, minimise or mitigate loss for the user during faults.

Have the vehicle's braking and gas systems inspected and repaired by an authorised specialist workshop only.

Alterations to the body are only to be carried out with the authorisation of the manufacturer.

The vehicle is designed for the exclusive transport of persons. Luggage and accessories may only be transported up to the maximum permissible gross weight.

Observe the test and inspection periods stipulated by the manufacturer.

## 1.2 Environmental tips



- ▷ Be considerate of the environment.
- ▷ Remember that: All kinds of waste water and household waste are not to be disposed of in drains or in the open countryside.
- ▷ On board, collect waste water only in the waste water tank or – if necessary – in other containers designed for that purpose.
- ▷ Only empty the waste water tank and toilet cassette or sewage tank at disposal stations at the camping or caravan sites, which are especially provided for this purpose. When stopping in towns and communities, observe the instructions at caravan sites or ask where there are disposal stations.
- ▷ Empty waste water tank as often as possible, even when it is not completely full (hygiene).
- ▷ If possible, flush out waste water tank and, if necessary, drainage pipe with fresh water every time it is emptied.
- ▷ Never allow the toilet cassette or sewage tank to become too full. Empty the toilet cassette or sewage tank frequently, at the latest as soon as the level indicator lights up.
- ▷ Separate household waste according to glass, tin cans, plastic and wet waste also when on a journey. Enquire at the town or community authority about disposal points. Household waste is not to be disposed of in waste paper baskets which are situated at car parks.
- ▷ Empty waste bins as often as possible into the containers provided for this purpose. This helps to avoid unpleasant smells and an accumulation of rubbish on board.



- ▷ When parked, do not allow the engine to run more than necessary. When running idle, a cold engine releases more contaminants than usual. The running temperature of the engine is achieved more quickly whilst the vehicle is in motion.
- ▷ Use an environmentally-friendly WC chemical agent for the WC which can also be biologically degraded and only use small doses.
- ▷ When staying in towns and communities for long periods, search for parking areas that are specially reserved for motorhomes. Enquire at the town or community authority about parking spaces.
- ▷ Always leave the parking places in a clean condition.



## 2.1 Bürstner Warranty Conditions



1. BÜRSTNER GmbH & Co. KG, Weststraße 33, 77694 Kehl (Guarantor) grants a 10-year water ingress warranty on vehicles manufactured from model year 2019 onwards, up to a maximum mileage of 120,000 km and that the following components of the caravan or motorhome are sealed in such a way that there is no ingress of moisture from the outside to the inside (interior) during normal, contractual and non-commercial use of the vehicle.

Exterior connecting seams:

- Roof/side wall
- Roof/rear wall
- Roof/driver's cabin
- Walls/underbody
- Chassis/underbody

Outer seal seams between built-in parts and the cut-outs of the body:

- Doors
- Windows
- Service and garage flaps
- Skylights
- Water filling devices
- Power supply flaps

The party covered by the warranty is responsible for proving that the vehicle is covered by the warranty.

2. In the event of proof of a warranty claim due to faulty sealing (cf. Point 1.), the guarantor is exclusively obliged under these warranty conditions to repair the affected body parts free of charge or to replace the affected parts, depending on what the guarantor considers necessary to remedy the water ingress. The required work shall be carried out by the guarantor or by an authorised workshop in accordance with the guarantor's guidelines. Should additional costs arise while remedying the water ingress due to installations or other changes to the vehicle compared to the original condition, these shall be borne by the guarantor. The cost of warranty work carried out by neither the guarantor nor one of the guarantor's authorised workshops is non-refundable, irrespective of the existence of a warranty claim. The party covered by the warranty shall not be entitled to other claims under this warranty, in particular regarding subsequent delivery, withdrawal from the purchase contract, price reduction or compensation for damages (including consequential damages), as well as compensation for direct or indirect, material or immaterial consequential damages. Excluded are e.g. claims for compensation for transport or travel costs, towing costs, loss of earnings or holiday cancellation, as well as compensation for futile expenditure. The legal rights of the party covered by the warranty with regards to its seller remain unaffected by this warranty. The legal rights of the party covered by the warranty with regards to its seller remain independent of claims under this warranty.

3. Depending on which occurs earlier, the warranty period begins either on the date of first registration or on the handover of the vehicle to the original purchaser, but no later than one year after the first delivery of the vehicle to the dealer.  
It applies for the duration of the vehicle's usability, but no longer than 10 years or up to a maximum mileage of 120,000 km, whichever occurs earlier. Change of ownership of the vehicle does not affect the warranty. The warranty shall expire if the yearly inspections required in accordance with Point 4. are not carried out. The performance of warranty work does not extend the warranty period, nor does it result in the period starting anew.
4. The successful assertion of a warranty claim is dependent on the vehicle undergoing a yearly water ingress test at a BÜRSTNER authorised workshop. This inspection shall be carried out each year within the 11th to 13th month after the beginning of the warranty period (cf. Point 3.). The costs of carrying out the water ingress test shall be borne by the party covered by the warranty. Claims under this warranty by the party covered by the warranty are only valid if the performance of the yearly inspections has been properly verified by a BÜRSTNER authorised workshop.  
This includes an inspection record filled out by the BÜRSTNER authorised dealer. Proof of the regular performance of water ingress tests shall be provided by the party covered by the warranty.
5. The occurrence of water ingress, or moisture indicative of water ingress, shall be reported by the party covered by the warranty to a BÜRSTNER authorised workshop, in writing, within 15 days of becoming aware of the issue. Knowledge is equivalent to grossly negligent and negligent ignorance. Compliance with the 15-day deadline is dependent on receipt of the notification at a BÜRSTNER authorised workshop. The notification shall be attached to the warranty document. If the water ingress is not reported correctly and in due time, no claims under this warranty are possible.
6. The necessity, method and scope of remedying the water ingress is at the sole discretion of the guarantor or its authorised workshops.
7. Warranty claims are excluded in the event of:
  - Forces of nature (e.g. floods, hail, etc.) and animal damage of any kind.
  - Damage resulting from an accident.
  - Water ingress due to conversions or additions to the vehicle that were not carried out by a BÜRSTNER authorised workshop.
  - Water ingress due to improper damage repairs that were not carried out by a BÜRSTNER authorised workshop.
  - Damage to the outer shell discovered during inspections that was not repaired immediately by the party covered by the warranty.
  - Aluminium corrosion that cannot be attributed to water ingress.
  - If the vehicle is modified using spare parts that have not been authorised by BÜRSTNER, and a warranty claim arises as a result.
  - Condensation due to insufficient ventilation.
  - Improper, non-contractual handling and use of the vehicle.
  - Damage due to incorrect use of care products or cleaning agents (see "Care" instructions in the instruction manual.)



- Damage due to non-compliance with the instruction manual or the manufacturer’s repair and maintenance instructions.
  - All other damages that are not the responsibility of the guarantor or an authorised workshop of the guarantor.
8. Water ingress tests are subject to a fee. The costs of the inspections shall be paid by the party covered by the warranty (cf. Point 4).
  9. As far as legally permissible, the exclusive place of jurisdiction shall be Kehl, Germany. The place of performance for all claims under this Warranty is Kehl. This warranty is governed exclusively by the law of the Federal Republic of Germany. This applies regardless of the place of residence or business of the party covered by the warranty.

## 2.2 Proof of water ingress tests

### Providing proof



- ▷ The annual water ingress tests are a prerequisite for the weatherproof guarantee of the housing body.

It is mandatory that the inspection record is filled in completely, entered in the online system, and printed out for you after each carried out test by your dealer.

### 2.2.1 Vehicle data

The following inspection records apply exclusively to the vehicle:

Datum	Entry
Model, type	
Chassis number	
Key no.	
First registration / date of handover	
<b>Purchased from company</b>	

## 2.2.2 Water ingress test (certificates)

12 months _____	
Stamp of the Bürstner dealer	
Date	Signature

24 months _____	
Stamp of the Bürstner dealer	
Date	Signature

36 months _____	
Stamp of the Bürstner dealer	
Date	Signature

48 months _____	
Stamp of the Bürstner dealer	
Date	Signature

60 months _____	
Stamp of the Bürstner dealer	
Date	Signature

72 months _____	
Stamp of the Bürstner dealer	
Date	Signature

84 months _____	
Stamp of the Bürstner dealer	
Date	Signature

96 months _____	
Stamp of the Bürstner dealer	
Date	Signature

108 months _____	
Stamp of the Bürstner dealer	
Date	Signature

Date: August 2018

## Chapter overview

This chapter contains important safety instructions. The safety instructions are for the protection of persons and property.

### 3.1 Fire prevention

#### 3.1.1 Avoidance of fire risks



- ▶ Never leave children in the vehicle unattended.
- ▶ Keep flammable materials clear of heating and cooking appliances.
- ▶ Halogen lamps can get very hot. When the light is switched on, there must always be a safety distance of 30 cm between light and flammable objects. Fire hazard!
- ▶ Never use portable heating or cooking appliances.
- ▶ Only authorised qualified personnel may make changes to the electrical system, gas system or appliances.

#### 3.1.2 Fire-fighting



- ▶ Always carry a dry powder fire extinguisher in the vehicle. The fire extinguisher must be approved, tested and close at hand.
- ▶ Have the fire extinguisher tested at regular intervals by authorised qualified personnel. Observe the date of testing.
- ▶ Depending on the equipment, the fire extinguisher is included in the scope of delivery.
- ▶ Always keep a fire blanket near the cooker.
- ▶ Observe the country- and location-specific requirements for fire-fighting in the place where you are staying and keep the required tools on hand.

#### 3.1.3 In case of fire



- ▶ Evacuate all passengers.
- ▶ Cut off the electrical power supply and disconnect from the mains.
- ▶ Close regulator tap on the gas bottle.
- ▶ Sound the alarm and call the fire brigade.
- ▶ Fight the fire if this is possible without risk.



- ▷ Acquaint yourself with the position and operation of the emergency exits.
- ▷ Keep escape routes clear.
- ▷ Observe the fire extinguisher instructions for use.

### 3.2 General



- ▶ The oxygen in the vehicle interior is used up by breathing and the use of gas operated appliances. That is why the used air must be replaced permanently. For this purpose, forced ventilation options (e.g. skylights with forced ventilation, mushroom-shaped vents or floor vents) are fitted to the vehicle. Never cover or block forced ventilations from the inside or outside with objects such as e.g. a winter mat. Keep forced ventilations clear of snow and leaves. There is a danger of suffocation due to increased CO<sub>2</sub> levels.
- ▶ Do not use storage spaces or rear garages as places for people or animals to stay or sleep in. These spaces are not forced-air ventilated. There is a danger of suffocation due to oxygen deprivation or exhaust from the heater.
- ▶ Observe the headroom of the doors.



- ▷ As far as the fitted appliances (heater, cooker, refrigerator, etc.) and the base vehicle (engine, brakes, etc.) are concerned, the instruction manuals are authoritative. It is imperative that they be observed.
- ▷ Fitting accessories or optional equipment can alter the dimensions, weight and road behaviour of the vehicle. Some of the add-on parts must be entered in the vehicle documents.
- ▷ Only use wheel rims and tyres which are approved for the vehicle. Information concerning the size of the approved wheel rims and tyres is included in the vehicle documents or can be obtained from authorised dealers and service centres.
- ▷ Firmly apply the handbrake when parking the vehicle.
- ▷ If the maximum permissible gross weight of the vehicle exceeds 4 tonnes, wheel chocks must be used when parking on gradients. The wheel chocks are provided as standard for vehicles which have a maximum permissible gross weight exceeding 4 t.



- ▷ When leaving the vehicle, it is imperative that all doors, external flaps and windows are closed.
- ▷ Always carry the legally prescribed equipment (e.g. first aid kit, warning vest, hazard warning triangle etc.) with you. The regulations of the host country apply when travelling abroad.
- ▷ The vehicle may only be driven by drivers who hold a driving licence which is valid for the respective vehicle class.
- ▷ When selling the vehicle, hand over all instruction manuals for the vehicle and the fitted appliances.

### 3.3 Road safety



- ▶ Before commencing the journey, carry out a functional check of indicating and lighting equipment, the steering and the brakes.
- ▶ If the vehicle has been stationary for a long period (approx. 10 months) have the braking and gas systems checked by an authorised specialist workshop.
- ▶ Before commencing the journey and after short interruptions of the journey, ensure that the entrance step is completely retracted.
- ▶ Before commencing the journey, open and secure the shades on the windscreen and on the driver's and front passenger's windows.
- ▶ Before commencing the journey, place and secure the flat screen and screen holder in the initial position.
- ▶ Before commencing the journey, remove the loose sink cover and store it securely in the kitchen unit or wardrobe.
- ▶ Before commencing the journey, carefully store all moving parts and all loose objects.
- ▶ Before commencing the journey, fix adjustable tables.
- ▶ Before commencing the journey, rotate all swivel seats in the direction of travel and lock in position. During the journey, the swivel seats must remain locked in place in the direction of travel.
- ▶ During the journey, persons are only to sit on the permitted seats (see chapter 5). The authorised number of seats is stipulated in the vehicle documents.
- ▶ Seat belts must be worn by all passengers.
- ▶ Fasten your seat belts before the beginning of the journey and keep them fastened during the journey.
- ▶ When travelling, secure children under 13 years of age that are smaller than 150 cm, with a suitable and officially approved child restraint system.
- ▶ Only attach the child restraint system to seats that are specified for this purpose. We strongly recommend to install child restraint systems preferably in the second row of seats.
- ▶ **Never** use rearward-facing child restraints on a seat with **activated front airbag**. This may lead to **death** or to **serious injuries** in children.
- ▶ The base vehicle is a commercial vehicle (small truck). Adjust your driving technique accordingly.
- ▶ In case of underpasses, tunnels or similar obstacles, note the total height of the vehicle (including the roof load).
- ▶ In winter, the roof must be free of snow and ice before commencing the journey.
- ▶ Check tyre pressure before a journey or every 2 weeks. Wrong tyre pressure causes excessive wear and can lead to damage or even to tyre burst. You can lose control of the vehicle (see section 14.6).
- ▶ Do not operate the heater at petrol stations. Danger of explosion!
- ▶ Do not operate the heater in closed spaces. Danger of suffocation!



- ▷ Before commencing the journey, distribute the payload evenly within the vehicle (see chapter 4).
- ▷ When loading the vehicle and during breaks in the journey, e.g. when re-loading luggage or food, observe the technically permissible maximum laden mass and the technically permissible maximum laden mass on the axle (see the vehicle documents).
- ▷ Before commencing the journey, close and lock, if possible, all inner doors, adjustable partition walls, drawers and flaps. Engage the refrigerator door securing device.
- ▷ Before commencing the journey, close windows and skylights.
- ▷ Before commencing the journey, close all external flaps and lock them.
- ▷ Before commencing the journey, remove the external supports and retract the corner steadies or steady legs, which are fitted to the vehicle.
- ▷ Before commencing the journey, put the antenna in park position.
- ▷ During the initial journey and each time after changing a wheel, re-tighten the wheel bolts/wheel nuts after 50 km (30 miles). Subsequently inspect them at regular intervals in order to ensure that they are firmly seated. See chapter 14 for tightening torque.
- ▷ Tyres should not be older than 6 years as the material becomes brittle over time (see chapter 14).
- ▷ When using snow chains, the tyres, wheel suspension and steering are subjected to an additional load. When using snow chains, drive slowly (maximum speed 50 km/h) and only on streets which are completely covered with snow. Otherwise the vehicle could be damaged.

### 3.4 Towing



- ▶ Care is to be taken when connecting and detaching a trailer. Risk of accident and injury!
- ▶ No persons are to be between the towing vehicle and the trailer during positioning for connecting and detaching.

### 3.5 Gas system

#### 3.5.1 General instructions



- ▶ The operator of the gas system is responsible for the performance of recurring inspections and for complying with the maintenance intervals.
- ▶ Before commencing the journey, when leaving the vehicle or when the gas devices are not in use, close all gas isolator taps and the main regulator tap on the gas bottle.
- ▶ All gas-operated devices (heater, cooker, oven, grill, refrigerator - depending on the equipment) must be switched off for refuelling, on ferries or in the garage. Danger of explosion!
- ▶ Do not use gas-operated devices in closed spaces (e.g. garages). Danger of poisoning and suffocation!



- ▶ Only have the gas system maintained, repaired or altered by an authorised specialist workshop.
- ▶ Have the gas system checked by an authorised specialist workshop according to the national regulations before commissioning. This also applies for not registered vehicles. For modifications to the gas system have the gas system immediately checked by an authorised specialist workshop.
- ▶ The gas pressure regulator, the gas tubes, and the exhaust gas pipes must also be inspected. The gas pressure regulator and the gas tubes must be replaced observing the nationally defined deadlines (the latest after 10 years). The vehicle owner is responsible for seeing that this is carried out.
- ▶ In case of a defect of the gas system (gas odour, high gas consumption) there is danger of explosion! Close regulator tap on the gas bottle immediately. Open doors and windows and ventilate well.
- ▶ If the gas system is defective: Do not smoke; do not ignite any open flames, and do not operate electric switches (light switches etc.). Check the tightness of gas-conducting parts and lines with leakage search spray. Do not check with an open flame.
- ▶ Only the stipulated devices may be connected to internal connections. Do not operate any device outside the vehicle if it is connected to an internal connector.
- ▶ Before using the cooker make sure that there is sufficient ventilation. Open a window or the skylight.
- ▶ Cooking is prohibited during the journey.
- ▶ Do not use gas-operated cooking and baking facilities for heating purposes.
- ▶ If there are several gas devices, each gas device must have its own gas isolator tap. If individual gas devices are not in use, close the respective gas isolator tap.
- ▶ Ignition safety valves must close within 1 minute after the gas flame has extinguished. A clicking sound is audible. Check function from time to time.
- ▶ The built-in gas devices are exclusively meant for use with propane or butane gas or a mixture of both. The gas pressure regulator as well as all built-in gas devices are designed for a gas pressure of 30 mbar.
- ▶ Propane gas is capable of gasification up to -42 °C, whereas butane gas gasifies at 0 °C. Below these temperatures no gas pressure is available. Butane gas is unsuitable for use in winter.
- ▶ Due to its function and construction, the gas bottle compartment is a space which is open to the exterior. Never cover or block up the standard forced ventilations. Otherwise gas that is emitted can not be diverted to the outside.
- ▶ The gas bottle compartment must not be used as storage space.
- ▶ Secure the gas bottle compartment against unauthorised access. To do this, lock the compartment.
- ▶ The regulator tap on the gas bottle must be accessible.
- ▶ Only connect gas-operated devices which have been designed for a gas pressure of 30 mbar.



- ▶ The exhaust gas pipe must be fitted tightly to the heating system and to the vent and must be sealed. The exhaust gas pipe must not show any evidence of damage.
- ▶ Exhaust fumes must be able to escape into the atmosphere unhindered and fresh air must be able to enter unhindered. For this reason, keep the exhaust pipe and intake openings clean and unobstructed (e.g. free from snow and ice). For this reason, no snow walls or aprons may lie against the vehicle.

### 3.5.2 Gas bottles



- ▶ Handle full or emptied gas bottles outside the vehicle only with closed regulator tap and attached protective cap.
- ▶ Gas bottles are only to be transported within the designated gas bottle compartment.
- ▶ Place the gas bottles in vertical position in the gas bottle compartment.
- ▶ Fasten the gas bottles so that they are unable to turn or tilt.
- ▶ Connect the gas tube to the gas bottle without tension.
- ▶ If the gas bottles are not connected to the gas tube, always place the protective cap on top.
- ▶ Close the regulator tap on the gas bottle before the gas pressure regulator or gas tube are removed from the gas bottle.
- ▶ Depending on the connection, unscrew the gas tube from the gas bottle and screw it on the gas bottle again by hand or using a suitable special spanner. The screw connection on the gas bottle generally has a left-hand thread. **Do not** tighten too firmly.
- ▶ Only use special gas pressure regulators with a safety valve designed for vehicle use. Other gas pressure regulators are not permitted and cannot meet the demanding requirements.
- ▶ Use only 11 kg or 5 kg gas bottles. (Gas bottle sizes may vary depending on the country.) Camping gas bottles with built-in check valve (blue bottle with max. 2.5 or 3 kg content) are can be used in exceptional cases with a safety valve.
- ▶ Use the shortest possible tube lengths (150 cm max.) for external gas bottles.
- ▶ Never block the floor ventilation openings below the gas bottles.



### 3.6 Electrical system



- ▶ Only allow qualified personnel to work on the electrical system.
- ▶ Prior to carrying out work on the electrical system, switch off all devices and lights, disconnect the battery and disconnect the vehicle from the mains.
- ▶ Only use original fuses with the stipulated values.
- ▶ Only replace defective fuses when the cause of the defect is known and has been remedied.
- ▶ Never bridge or repair fuses.

### 3.7 Water system



- ▶ Water left standing in the water tank or in the water pipes becomes undrinkable after a short period. Therefore, before each use of the vehicle, thoroughly clean the water pipes and the water tank. After each use of the vehicle completely empty the water tank and the water pipes.
- ▶ In the case of lay-ups lasting more than a week disinfect the water system before using the vehicle (see section 12.3.3).



- ▷ If the vehicle is not used for several days or if it is not heated when there is a risk of frost, empty the entire water system. Make certain that the water pump is switched off on the panel. Otherwise, the water pump will overheat and may get damaged. Leave the water taps on in central position. Leave the safety/drainage valve (if there is one) and all drain cocks open. Frost damage to appliances, frost damage to the vehicle and deposits in water-carrying components can be avoided in this way.



## Chapter overview

This chapter contains important information which has to be noted before commencing your journey or carrying out any tasks before the journey.

At the end of the chapter there is a checklist which once again summarises the most important points.

### 4.1 Keys

The following keys are included with your vehicle:

Two keys for

- ignition lock
- driver's and passenger's doors
- fuel tank

Two keys for

- conversion door of the body
- drinking water filler neck
- external flaps

Always deposit a replacement key outside the vehicle. Make a note of the key number. Our authorised dealers and workshops can offer assistance in case of loss.

### 4.2 Registration

Your vehicle is a motor vehicle subject to registration. Observe national regulations on registration.

Please remember that certain countries require a separate national code sticker in addition to the EU plate.

### 4.3 Vehicle load capacity



- ▶ Overloading the vehicle and the axles may result, for example, in a diminished steering response (altered driving behavior), an overloading of the tires, and, as a result, an increased risk of tire blowouts or an extended braking distance. This may cause you to lose control of the vehicle, endangering yourself and other road users.  
If you are not sure whether the loaded vehicle complies with the technically permissible maximum laden mass, you can weigh/check the vehicle on public scales or have it weighed by certain dealers.
- ▶ The vehicle documents state the technically permissible maximum laden mass or the mass including optional equipment ex works (actual vehicle mass), but not the weight of the laden vehicle (see section 4.3.1). For your own safety, we recommend that you have your loaded vehicle (with all passengers, luggage and personal objects) weighed on a public weighbridge before you set out on your journey.
- ▶ Adapt the speed to the payload. The stopping distance is increased if the payload is high.



- ▷ Do not exceed the technically permissible maximum laden mass and the technically permissible maximum laden mass on the axle as stated in the vehicle documents by the payload.
- ▷ Built-in accessories and optional equipment reduce the vehicle load capacity.
- ▷ On loading, make sure that the payload's centre of gravity is as low as possible (directly above the floor of the vehicle). Otherwise this may affect the driving characteristics of the vehicle.



- ▷ If you drive the vehicle even though it exceeds the technically permissible maximum laden mass specified by the manufacturer, you may face legal consequences, such as a fine or loss of insurance.

### Maximum permissible payloads

Description	Load (kg)
Pull-down bed	200
Roof load	90
Rear garage and rear storage space	150
Bike rack, not lowerable	double/triple 60
Bike rack, lowerable	double/triple 60
Door sill	120

### 4.3.1 Terms



- ▷ Technically speaking, the term "mass" has now replaced the term "weight". However, "weight" is still the term more frequent in common use. For better understanding, "mass" is therefore only used in the following sections for fixed formulations.

### Technically permissible maximum laden mass

The technically permissible maximum laden mass is a value specified by the manufacturer that, for safety reasons, the vehicle must never exceed, even when loaded (e.g. 3,500 kg). Information on the technically permissible maximum laden mass of the model you have chosen can be found in the registration papers and on the body manufacturer's nameplate in the vehicle.

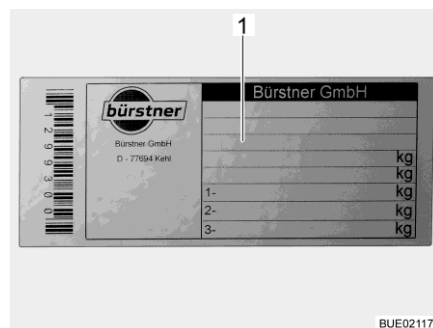

1 Chassis number

Fig. 1 Nameplate

The technically permissible maximum laden mass consists of the **actual vehicle mass** and the **payload**.

The manufacturer has specified the technically permissible maximum laden mass (maximum permissible gross weight) under CoC 16.1 in the CoC vehicle documents.

**Actual vehicle mass** The actual vehicle mass consists of the mass in running order and the weight of the optional equipment fitted at the factory.

**Mass in running order** The mass in running order is the weight of the ready-to-drive series vehicle (excluding optional equipment fitted at the factory).

The mass in running order is made up as follows:

- Unladen weight (mass of the empty vehicle) with factory-installed standard equipment (excluding optional equipment fitted at the factory)
- Driver's weight
- Basic equipment weight
- Greases, oils and cooling liquids filled in
- Fresh water tank filled up to 100 %
- Aluminium gas bottle filled up to 100 %
- Fuel tank filled to 90 %

75 kg are calculated for the weight of the driver, regardless of how much the driver really weighs.

Basic equipment includes all equipment and fluids required for safe and proper vehicle use. The weight of the basic equipment includes:

- A full fresh water system
- A full heating system
- The power cables for the 230 V power supply
- A full toilet flushing system
- The installation kit for an auxiliary battery if an auxiliary battery can be used

The waste water and sewage tanks are empty.

**Example for calculating the basic equipment**

Water tank in the ready-to-drive state with 20 l (overflow open)	20 kg
Aluminium gas bottle	+ 11.5 kg
Boiler with 20 l	+ 20 kg
230 V power cable	+ 4 kg
<b>Total</b>	<b>= 55.5 kg</b>

The vehicle mass in a ready-to-drive condition is specified under CoC 13 in the CoC vehicle documents (e.g. 2900 kg). The actual vehicle mass is specified under CoC 13.2 in the CoC vehicle documents (e.g. 2950 kg).

**Remaining load capacity** To determine the remaining load capacity, it is important that you know the actual weighed mass of your vehicle. Upon completion of your vehicle, therefore, we determine the actual weight of your vehicle for the first time by weighing it at the end of the line. This includes the mass in running order plus the weight of all ordered and factory-fitted optional equipment.

You can use this actual weighed mass to calculate the remaining load capacity for baggage or other accessories.

**Example:**

Technically permissible gross weight – actual weighed mass – mass of passengers = remaining load capacity

$$3500 \text{ kg} - 3000 \text{ kg} - 225 \text{ kg} (3 \times 75 \text{ kg}) = 275 \text{ kg}$$



- ▷ Please note that the factory calculation of the remaining load capacity for the mass of the driver (included in the actual weighed mass) and the mass of the passengers is based on a generalized mass of 75 kg per seat. Due to deviating body weights, however, the actual remaining load capacity of your vehicle may vary.
- ▷ The actual factory-weighed mass of your vehicle may vary slightly afterwards due to weather conditions and, for example, the associated absorption or release of moisture. Any further subsequent modification of your vehicle, e.g. through the additional installation of accessories by the dealer or other attachments and/or conversions, will additionally influence the actual weighed mass of the vehicle communicated and consequently also the remaining load capacity. It is the responsibility of the dealer after picking up the vehicle at the factory until delivery, and subsequently your responsibility from the time of handover by the dealer, to ensure that the technically permissible maximum laden mass is not exceeded. If you are not sure whether the loaded vehicle complies with the technically permissible maximum laden mass, you can weigh/check the vehicle on public scales or have it weighed by certain dealers.
- ▷ We will inform your dealer of the actual weighed mass of your vehicle and the remaining load capacity when we issue the invoice. Your dealer is required to pass on the information to you. If you have not received this information, you can contact your dealer and request it. Our scales meet all legal and standard requirements and are regularly maintained, tested and, calibrated. Nevertheless, a slight tolerance is technically unavoidable. Moreover, the weight of the vehicle may vary slightly due to weather conditions and, for example, the associated absorption or release of moisture. The actual weight of the vehicle may therefore deviate from the actual weight communicated by a few kilograms.

The payload is made up as follows:

- Conventional load
- Optional equipment
- Personal equipment



- ▷ The vehicle load capacity can be increased by reducing the actual vehicle mass. To do this, it is allowed for example to empty the fluid containers or to remove the gas bottles.

You will find explanations on the individual components of the payload in the following text.

- Conventional load** The conventional load is the weight specified by the manufacturer for the passengers.
- Conventional load means: 75 kg are calculated for every seat specified by the manufacturer, regardless of how much the passengers actually weigh. The driver's seat is already included in the mass in running order and must **not** be counted.
- The manufacturer specifies the number of seats under CoC 42 in the CoC vehicle documents.
- Optional equipment** Optional equipment includes all equipment not included in the standard equipment which is fitted to the vehicle under the responsibility of the manufacturer.
- Caravan coupling
  - Awning
  - Bike or motorcycle rack
  - Satellite unit
  - Microwave oven
- Information about the weights of the various optional equipment devices can be obtained from the manufacturer.
- Personal equipment** Personal equipment includes all items carried in the vehicle that are not included in the conventional load and optional equipment. For example, personal equipment can include the following:
- Foodstuffs
  - Crockery
  - Television
  - Radio
  - Clothes
  - Bedding
  - Toys
  - Books
  - Toiletries
- No matter where kept, personal equipment also includes:
- Animals
  - Bikes
  - Boats
  - Surfboards
  - Sports equipment
- For the personal equipment, according to the applicable regulations, the manufacturer must use a minimum weight that is determined according to the following formula:
- Formula** Minimum weight M (kg) =  $10 \times N + 10 \times L$
- Explanation** N = maximum number of people including the driver, as stated by the manufacturer
- L = total length of the vehicle in metres

### 4.3.2 Calculating the vehicle load capacity



- ▶ The payload calculation at the factory is partly based on all-inclusive weights. For safety reasons, the technically permissible maximum laden mass must not be exceeded.
- ▶ The vehicle documents state the technically permissible maximum laden mass or the mass including optional equipment ex works (actual vehicle mass), but not the weight of the laden vehicle (see section 4.3.1). For your own safety, we recommend that you have your loaded vehicle (with all passengers, luggage and personal objects) weighed on a public weighbridge before you set out on your journey.

The vehicle load capacity (see section 4.3.1) is the difference in weight between

- the technically permissible maximum laden mass and
- the actual vehicle mass.

#### Example for calculating the vehicle load capacity

	Mass in kg to be calculated	Calculation
Technically permissible maximum laden mass according to CoC 16.1	3500	
Actual vehicle mass including standard equipment according to CoC 13.2	- 3070	
<b>This results in a permissible payload of</b>	<b>430</b>	

The calculation of the vehicle load capacity from the difference between the technically permissible maximum laden mass and the actual vehicle mass specified by the manufacturer is however only a theoretical value.

Only if the vehicle is weighed on a public scale with filled tanks (fuel and water), filled gas bottles and complete optional equipment (and accessories) can the actual vehicle load capacity be determined.

To do this, proceed as follows:

- First only drive the vehicle on to the weighbridge with the front wheels and have it weighed.
- Then drive the vehicle on to the weighbridge with the back wheels and have it weighed.

The individual values give the current axle loads. These are important for the correct loading of the vehicle (see section 4.3.3). The sum of these values is the current weight of the vehicle.

The actual vehicle load capacity is the difference between the technically permissible maximum laden mass and the weighed vehicle weight.

This can be used to determine the weight that remains for the personal equipment:

- Determine the weight of the passengers and subtract it from the value for the actual vehicle load capacity.

The result is the weight that is permitted for the actual load of the personal equipment.



### 4.3.3 Load securing and load distribution



- ▶ For safety reasons, never exceed the technically permissible maximum laden mass.
- ▶ Distribute the load evenly on the left and right sides of the vehicle.
- ▶ Distribute the load evenly on both axles. Observe the technically permissible maximum laden mass on the axle specified in the vehicle documents. Observe the permissible load-carrying capacity of the tyres (see chapter 14).
- ▶ Heavy loads behind the rear axle can reduce the load on the front axle due to the leverage effect ( $\frac{L}{L_0} \cdot \frac{1}{2}$ ). This applies especially to long rear extensions, if a motorbike is transported on the rear carrier or if there is a heavy load in the rear storage space. The release of the front axle negatively affects the driving quality, especially for front-driven vehicles.
- ▶ Store all objects in such a way that they cannot slip.
- ▶ Store heavy objects (awning, tin cans, etc.) close to the axles. Low-lying storage spaces whose doors do not open in the direction of travel are particularly suited for storing heavy objects.
- ▶ Stack light objects (laundry) in the roof storage cabinets.
- ▶ Load the bike rack with bicycles only (max. three units).

Large storage compartments also offer room for heavy objects. The mass on the front or rear axle may be exceeded as a result.

However, the individual axles may not be overloaded under any circumstances. That is why it is important, at which distance to the axles the load is stored.

When loading the vehicle please observe the following instructions to ensure safe driving:

- Baggage and other items carried in the vehicle must be evenly distributed between the left and right sides of the vehicle.
- Heavy or bulky items should be stowed as close to the ground as possible in stowage boxes provided for this purpose and near the axles, and they must be secured against slipping.
- Light and other items can be stowed in lockers and storage compartments.
- Always ensure that the doors and flaps on the cabinets and storage compartments are properly secured.
- Use only suitable clamping systems to secure items against slipping. Please recheck all tie-downs before commencing travel.



- ▶ Uneven loading has a negative effect on driving behavior. A rear-heavy load in particular results in a reduction of the load on the front axle due to leverage effects and thus, for example, to a loss of traction, a diminished steering response (altered driving behavior), an overloading of the tires and, as a result, an increased risk of tire blowouts. This may cause you to lose control of the vehicle, endangering yourself and other road users. An evenly distributed load over the entire vehicle leads to optimum driving behavior during travel.



- ▷ The technically permissible maximum laden mass and the technically permissible maximum laden mass on the axle must not be exceeded. Especially when stowing or attaching heavy accessories or heavily laden accessories (such as motorcycle carriers or bicycle carriers) at the rear, the mass on the axle must be checked and complied with. If you are not sure whether the loaded vehicle complies with the technically permissible maximum laden mass and the technically permissible maximum laden mass on the axle, you can weigh/check the vehicle on public scales or have it weighed by certain dealers.
- ▷ For individual models, a maximum load is specified by the body manufacturer for cabinets, drawers, storage compartments, or other storage spaces. This maximum load can be seen on the stickers attached on site and must be observed at all times. However, the technically permissible maximum laden mass and the technically permissible maximum laden mass on the axle must not be exceeded under any circumstances. For this reason, please note that the stated maximum load may not be fully utilized if this would result in the exceedance of the technically permissible maximum laden mass or technically permissible maximum laden mass on the axle.
- ▷ Further information on correct loading can be found in the sections "Technically permissible maximum laden mass" (page 26), "Technically permissible maximum laden mass on the axle (mass on the axle)" (page 32) and "Rear garage/rear storage space" (page 35).

To distribute the load correctly, you will need a scale, a tape measure, a calculator and some time.

Two simple formulas are needed to calculate the effect of the weight of the load on the axles:

#### Formulas

$A \times G : R =$  weight on the rear axle

Weight on the rear axle –  $G =$  weight on the front axle

#### Explanation

A = distance between storage space and front axle in cm

G = weight of the load in the storage space in kg

R = wheelbase of the vehicle (distance between axles) in cm



- ▷ Measure the external distances horizontally from the centre of the front wheel to the centre of the storage space or to the centre of the back wheel.

#### Technically permissible maximum laden mass on the axle (mass on the axle)

The technically permissible maximum laden mass on the axle or group of axles (hereafter referred to as mass on the axle) refers to the vehicle- and axle-specific load that may be transferred from the wheels of an axle or group of axles to the road surface. The mass on the axle is a value specified by the manufacturer that, for safety reasons, the vehicle must never exceed, even when loaded. You will find information on the mass on the axle of your vehicle in the registration papers and on the body manufacturer's nameplate in the vehicle.

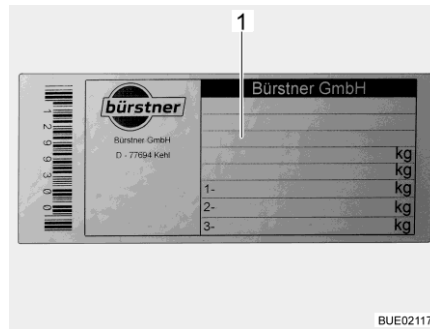

1 Chassis number

Fig. 2 Nameplate



- ▶ If the technically permissible maximum laden mass on the axle is exceeded, the vehicle may be damaged (e.g. due to a broken axle or tire blowout) and driving performance may be considerably impaired. This may cause you to lose control of the vehicle, endangering yourself and other road users. We therefore recommend weighing the final loaded vehicle including all passengers before commencing travel in order to ensure compliance with the mass on the axle and the technically permissible maximum laden mass at all times. For this purpose, you can weigh/check the vehicle on public scales or have it weighed by certain dealers.



- ▷ Please note that the mass on the respective axles or axle groups may differ. For this reason, please read the information provided in the registration papers carefully.
- ▷ If you drive the vehicle even though it exceeds the technically permissible maximum laden mass on the axle specified by the manufacturer, you may face legal consequences, such as a fine or loss of insurance.
- ▷ It is possible that the chassis manufacturer of your vehicle specifies a minimum load for the front axle in order to achieve optimum driving behavior. Therefore, please also always observe the information regarding this from the operating instructions of the chassis manufacturer.
- ▷ For further information on correct loading, please refer to the sections "Load securing and load distribution" (page 31) and "Rear garage/rear storage space" (page 35).

#### Calculating masses on the axles:

- Multiply the distance between storage space and front axle (A) with the weight of the load in the storage space (G) and divide the result by the wheelbase (R). The result is the weight of the load in the storage space on the rear axle. Make a note of this weight and of the storage space.
- In a second step, subtract the weight in the storage space (G) from the weight calculated beforehand. If the result is a **positive** value (example 1), this means that the load on the front axle is **reduced** by this value. If the result is a **negative** value (example 2), this means that the load on the front axle is **increased**. Make a note of this value, too.
- Calculate all storage spaces of the vehicle in the same way.
- In a last step, add all weights calculated for the rear axle to the mass on the rear axle and add (or subtract) all weights calculated for the front axle to (from) the mass on the front axle. How to determine the mass on the rear axle and front axle is described in section 4.3.2.

If the calculated value exceeds the permissible mass on the axle, the load must be distributed in a different way.

If the load on the front axle is too low, the grip of the tyres on the road is reduced (traction). This applies in particular to vehicles with front-wheel drive. In this case, the load must be redistributed, too.

#### Example calculation

		Example 1	Example 2
Distance to the front axle	A	(A1) 450 (cm)	(A2) 250 (cm)
Weight in the storage space	G	× 100 (kg)	× 50 (kg)
Wheelbase of the vehicle	R	÷ 325 (cm)	÷ 325 (cm)
<b>Load on the rear axle (add to the axle load)</b>		<b>138.5 (kg)</b>	<b>38.5 (kg)</b>
Weight in the storage space		- 100 (kg)	- 50 (kg)
<b>Load relief to the front axle (subtract from the axle load)</b>		<b>38.5 (kg)</b>	
<b>Load on the front axle (add to the axle load)</b>			<b>-11.5 (kg)</b>

#### Increase and reduction of load capacity

In the case of an increase of load capacity, a change in the chassis usually increases the technically permissible maximum laden mass of the vehicle, the technically permissible maximum laden mass on the axle and, as a result, the remaining load capacity for luggage, camping equipment, etc.

In contrast to an increase of load capacity, a reduction of load capacity reduces the technically permissible maximum laden mass of the vehicle, the technically permissible maximum laden mass on the axle and, as a result, the remaining load capacity for luggage, camping equipment, etc. As a rule, a technical modification of the chassis is not performed.



- ▷ Due to the change in the technically permissible maximum laden mass, increases or reductions of load capacity may affect the permitted seats, the chassis, and the mass on the axle. If you have any questions, feel free to contact the responsible technical testing center for advice.
- ▷ A reduction or increase of load capacity may result in changes to the legal requirements resulting from the new technically permissible maximum laden mass of the vehicle. This applies in particular to the legal requirements from the German Road Traffic Act (StVO), the German Road Vehicle Registration Regulation (StVZO), and tax and insurance regulations. An increase of technically permissible maximum laden mass to over 3500 kg may, for example, affect the driving license class or result in different speed limits or prohibitions on passing and overtaking. Toll payment requirements may also change due to the new technically permissible maximum laden mass. Therefore, inform yourself about the current legal situation with regard to the new technically permissible maximum laden mass of the vehicle and seek advice on this from the appropriate bodies. Please note that national regulations in the country of your destination and countries visited in transit may differ from those in your home country.
- ▷ For more information on the actual weighed mass of your vehicle and the remaining load capacity, please refer to section "Remaining load capacity" (page 27).

#### 4.3.4 Rear garage / rear storage space



- ▶ Observe the technically permissible maximum laden mass on the axle and the technically permissible maximum laden mass when loading the rear garage / rear storage space.
- ▶ The maximum permitted load of the rear garage / the rear storage space is 150 kg. Do not exceed the technically permissible maximum mass on the rear axle.
- ▶ Uneven loading or overloading has a negative effect on driving behavior. A rear-heavy load in particular results in a reduction of the load on the front axle due to leverage effects and thus, for example, to a loss of traction, a diminished steering response (altered driving behavior), an overloading of the tires and, as a result, an increased risk of tire blowouts. This may cause you to lose control of the vehicle, endangering yourself and other road users. An evenly distributed load over the entire vehicle leads to optimum driving behavior during travel. If you are not sure whether the loaded vehicle complies with the technically permissible maximum laden mass and the technically permissible maximum laden mass on the axle, you can weigh/check the vehicle on public scales or have it weighed by certain dealers.
- ▶ When transporting vehicles powered by gasoline, diesel, gas, or other flammable material, make sure that the tank of the transported vehicle is completely empty. When transporting electric bikes, we also recommend that you remove and securely stow the battery before commencing travel.
- ▶ Rear garages and rear storage compartments are not designed at the factory to function as sleeping or living areas for people or animals. These spaces are not provided with ventilation at the factory. There is a risk of suffocation due to a lack of oxygen.



- ▷ Depending on the vehicle equipment, clamping rails with clamping eyelets are mounted in the rear garage or in the rear storage space. Always secure loads onto the clamping eyelets. Always use tightening straps or lashing nets for securing the load, never rubber expanders.
- ▷ When clamping loads, always check that the clamping eyelets are placed tightly in the clamping rails. If the clamping eyelet is not anchored tightly in the clamping rail, the load may slide or loosen during forcible movements of the steering wheel or when braking.
- ▷ Distribute the load evenly. Excessive spot loads can lead to damages of the floor covering.
- ▷ If there is a pull-out present in the rear storage space: Make sure that the pull-out is engaged.
- ▷ Use the supporting system offered by your dealer if two-wheelers are transported in the rear garage.

When loading rear garages and rear storage compartments, please observe the following instructions to ensure safe driving:

- Baggage and items carried in rear garages and rear storage compartments must also be evenly distributed in accordance with the section "Load securing and load distribution" (page 31).
- All items stowed in rear garages and rear storage compartments must be fastened and secured accordingly using suitable clamping systems at the existing fastening points provided at the factory.
- Before driving off, it must be ensured that the rear garage or rear storage compartment is properly locked.



- ▷ Please observe the maximum permissible load of the rear garage or rear storage compartment at all times. The specified maximum permissible load of the rear garage or rear storage compartment may be influenced by the selection of further optional equipment, such as trailer couplings or frame extensions. However, the technically permissible maximum laden mass and the technically permissible maximum laden mass on the axle must not be exceeded under any circumstances. Especially when stowing or attaching heavy accessories or heavily laden accessories (such as motorcycle carriers or bicycle carriers) at the rear, the mass on the axle must be checked and complied with. For this reason, please note that the maximum load may not be fully utilized if this would result in the exceedance of the technically permissible maximum laden mass or technically permissible maximum laden mass on the axle.
- ▷ Further information on correct loading can be found in the sections "Technically permissible maximum laden mass" (page 26), "Technically permissible maximum laden mass on the axle (mass on the axle)" (page 32) and "Load securing and load distribution" (page 31).

#### 4.4 Bike rack (optional equipment)



- ▶ Observe the technically permissible maximum laden mass on the axle and the technically permissible maximum laden mass when loading bike rack.
- ▶ The total width of the vehicle must not be exceeded. Adjust the attachments for the bikes accordingly. The overhang to rear must be marked in accordance with the regulations for the country in which you are travelling.
- ▶ Load the bike rack with bicycles only (max. three units).
- ▶ Fasten bicycles using the straps provided and check to see that they are secure after you have driven a few kilometres.
- ▶ Check the secure attachment of the bicycles on the bike rack after the first 10 km and then at each break in the journey.
- ▶ Do not use the bike rack as luggage rack or ladder.



- ▷ The bike rack is only to be used for transporting bicycles.
- ▷ The gross weight specified by the manufacturer must not be exceeded.
- ▷ The identification plate and rear lights must not be covered.
- ▷ The maximum permitted payload of the bike rack is 60 kg.



- ▷ When loading the bike rack, observe the centre of gravity. If the bike rack is only loaded with **one** bicycle, position the bicycle as closely as possible to the vehicle wall.
- ▷ Driving with a folded out bike rack without bicycles is not permitted.
- ▷ Before every journey, check:
  - Is the bike rack without bicycles folded in correctly?
  - Are the bicycles securely fastened to the bike rack using the bike rack belts?

### Loading the bike rack with bicycles

When loading the bike rack, observe the centre of gravity. The centre of gravity of the bicycles must be as close as possible to the rear wall of the vehicle. The bike rack should always be loaded from the inside to the outside.

Loading the bike rack correctly:

- Depending on the model, fold the bike rack down or pull it out.
- Place the heaviest bicycle directly against the rear wall.
- Place the lightest bicycles in the centre or on the outside of the bike rack.
- Secure the front and rear wheels of each bicycle with the retaining straps on the bike rack.
- In addition, fasten the outermost bicycle depending on the model of the bike rack on the retaining bracket or retaining arm and to the spacer respectively.

If the bike rack is only loaded with **one** bicycle, position the bicycle as closely as possible to the rear wall.

### Bike rack, not lowerable



- ▷ Also read the manufacturer's instruction manual.



Fig. 3 Bike rack, not lowerable

Depending on the model, the bike rack can be used to transport 2 or 3 bicycles comfortably.

### Loading the bicycles:

- Fold the swivel clip down.
- Place the bicycles on top and secure them with quick straps.
- Fasten the spacer to the frame of the outermost bicycle.

## Bike rack, lowerable



- ▷ Also read the manufacturer's instruction manual.

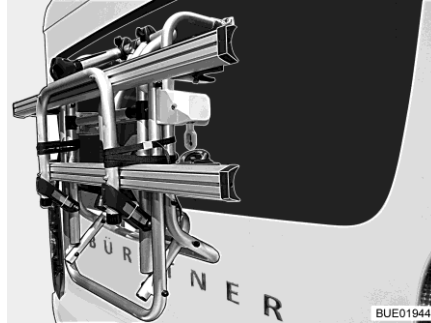

Fig. 4 Bike rack, folded upwards



Fig. 5 Bike rack, lowered

The bike rack (Fig. 4) permits to easily transport 2 bicycles. Expansion for 3 bicycles is possible. A winding system can be used to lift and lower the bike rack. The winding system brings the bicycles to gripping height within seconds.

## Loading the bicycles:

- Attach the hand crank (Fig. 5,1) to the bike rack and lower the bike rack to gripping height.
- Place the bicycles on top and secure them with quick straps.
- Fasten the bike-block spacer to the frame of the outermost bicycle.
- Use the hand crank to raise the bike rack again.

## 4.5 Towing



- ▶ Care is to be taken when connecting and detaching a trailer. Risk of accident and injury!
- ▶ No persons are to be between the towing vehicle and the trailer during positioning for connecting and detaching.
- ▶ Observe the permissible nose weight and rear axle load of the motorhome. Refer to the vehicle documents for the rear axle load.



- ▷ Trailer with an overrun brake: Do not connect or detach trailer with the overrun brake on.
- ▷ Caravan coupling with detachable ball neck: If the ball neck is mounted incorrectly, there is the danger of the trailer breaking away. Observe the operating manual for the caravan coupling.
- ▷ The tow ball only fits onto the supplied mount. If the tow ball must be replaced, the mount must also be replaced.
- ▷ If the vehicle is equipped with air suspension: The distance between the tow ball of the caravan coupling and the road must be 350 to 420 mm in loaded condition.



Depending on the model, different nose weights may apply for the caravan couplings. Refer to the following table for the respective permissible nose weight.

Model	Permissible nose weight
SAWIKO MT019	75 kg
SAWIKO (other)	100 kg
Linnepe	100 kg
AL-KO	80 kg

#### 4.6 Caravan coupling (optional equipment)



- ▶ When mounting a caravan coupling, see the vehicle documents for information on maximum nose weight and caravan load.
- ▶ Retighten the caravan coupling fixing screws after 1000 operating hours.



- ▷ The load rack and caravan coupling must not be used simultaneously.



- ▷ If the caravan coupling is retrofitted, this must be entered in the vehicle documents. The required documents are enclosed with the caravan coupling.
- ▷ If the caravan coupling was fitted at the factory, this is entered in the vehicle documents. Always keep the appropriate documents in the vehicle.
- ▷ Also read the manufacturer's instruction manual.



Fig. 6 Caravan coupling, rigid



Fig. 7 Caravan coupling, detachable

#### Entry in the vehicle documents

Have your dealer or service centre install the add-on parts. They will also take care of all the formalities for you.

#### 4.7 Electrically operated entrance step (partially optional equipment)



- ▶ Before commencing the journey and after short interruptions of the journey, ensure that the entrance step is completely retracted.
- ▶ Do not stand in the direct range of the entrance step while it is being retracted or extended.
- ▶ Do not reach into the mechanics of the entrance step while it is being retracted or extended. Danger of bruises!
- ▶ Do not step on the entrance step until it has extended completely. There is a risk of injury!
- ▶ Do not under any circumstances raise or lower persons or loads with the entrance step.



- ▷ Take note of the different step heights and make certain that the ground is firm and even when exiting.
- ▷ Do not grease or lubricate the pivot bearing and joints of the entrance step (see section 12.1.4).



- ▷ The button to operate the entrance step is located on the inside of the vehicle in the area of the conversion door.
- ▷ If the entrance step has been extended and the ignition is switched on, a signal tone sounds.

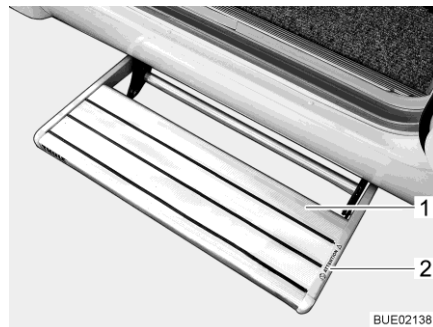

- 1 Entrance step
- 2 Warning notice "Risk of crushing" (present depending on the model)

Fig. 8 Entrance step

The vehicles have a one-step, electrically extendable entrance step (Fig. 8,1).

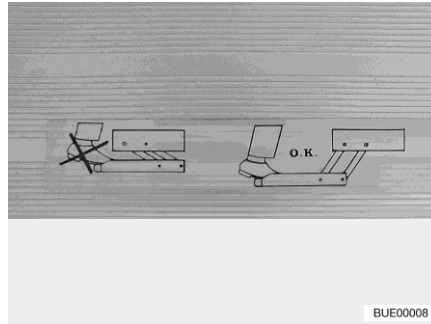

Fig. 9 Warning notice for entrance step

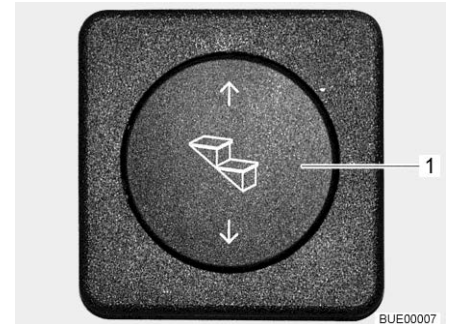

Fig. 10 Operating button for entrance step

Before stepping on the entrance step, fully extend it (Fig. 9).

**Extending:** ■ Press the rocker button (Fig. 10,1) down and hold it pressed (at least 3 seconds) until the entrance step has extended completely.

**Retracting:** ■ Press the rocker button (Fig. 10,1) up until the entrance step has retracted completely.

**Emergency operation:** ■ Make sure that the vehicle is securely parked.  
 ■ Make sure that the voltage supply is disconnected.  
 ■ Push step carefully and slowly by hand.

#### 4.8 Door sill (special equipment)



- ▶ There is a risk of slipping in wet conditions. Step onto the door sill carefully.
- ▶ The maximum permitted door sill load is 120 kg.

#### 4.9 TV unit (optional equipment)



- ▶ Before commencing the journey, place and secure the flat screen and screen holder in the initial position. If the screen holder is installed in a TV cabinet: Close TV cabinet.
- ▶ Before commencing the journey, ensure that the antenna is in park position. Danger of accidents! Park position means: The antenna points towards the back, is fully lowered and is locked in this position.



- ▷ Further information on positioning the flat screen can be obtained from chapter 7.

#### 4.10 Sink and drain basic covers (partially optional equipment)



- ▶ In the event of an accident or emergency braking, the loose sink (Fig. 11,1) and drain basin covers could injure the occupants of the vehicle. Before commencing the journey, take the loose covers off and store them securely in the kitchen unit or wardrobe.



Fig. 11 Sink cover (example)

#### 4.11 Kitchen extension board (depending on model)



- ▶ In the event of an accident or emergency braking, the kitchen extension board could injure the occupants of the vehicle. Before setting off, detach kitchen extension board (Fig. 12,2) from the rail (Fig. 12,1) and store securely.

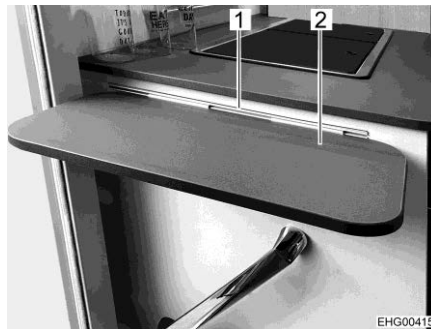

Fig. 12 Kitchen extension board

### 4.12 Securing add-on parts



► In the event of an accident or emergency braking, loose add-on parts could injure the occupants of the vehicle. Before setting off, secure loose add-on parts in the holders provided or stow them in a secure place inside the vehicle.



▷ Unsecured flaps and doors can spring open during the journey and damage parts of the interior. Secure all flaps and doors before setting off.

**Add-on parts** Add-on parts include bed widenings, ladders or table extensions.



Fig. 13 Bed widening in the rear garage

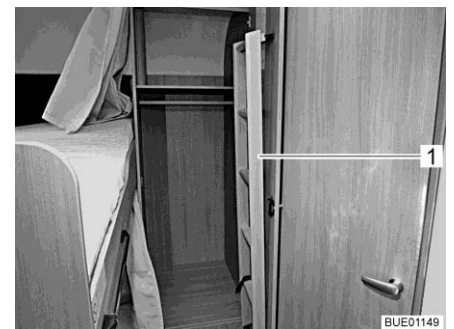

Fig. 14 Access ladder in the wardrobe

**Securing add-on parts:**

- Place the add-on parts (Fig. 13,1 and Fig. 14,1) in the holders provided and secure them with the available means of attachment.
- If no holder is provided for the add-on part, stow the add-on part in a storage space the doors of which cannot be opened in the direction of travel (e.g. wardrobe or rear storage space).

**Doors and flaps**

Doors are, for example, inner doors or partition walls. See section 7.3 for furniture flaps.

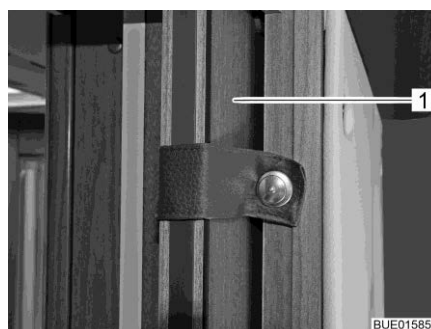

Fig. 15 Sliding door

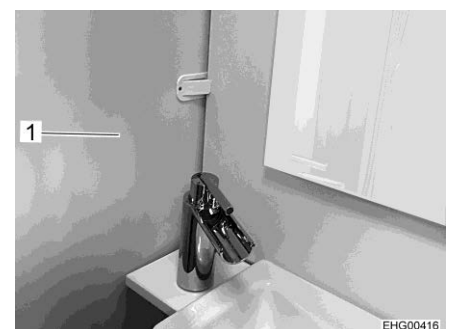

Fig. 16 Shower partition

**Securing doors:**

- Secure doors (Fig. 15,1) or partition walls (Fig. 16,1) with the locks or means of securing provided.



Fig. 17 Catch with spring

- Securing add-on part: ■ Push add-on part back until the spring (Fig. 17,1) engages.
- Releasing add-on part: ■ Push spring in.

### Coffee table of the rear seating group

A movable coffee table is installed in the seat box of the rear seating group.



Fig. 18 Bench and coffee table

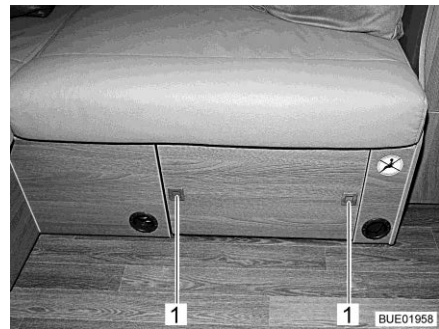

Fig. 19 Coffee table lock

- Securing the coffee table:
- Lower the coffee table.
  - Run the coffee table into the seat box.
  - Press the push buttons (Fig. 19,1) on the seat box panel. The coffee table is secured.

### 4.13 Gas regulator



- ▶ Operating gas-operated appliances during the journey is permitted only if the gas system has the relevant equipment. The hose break guard and crash protection unit (CPU) prevent the gas from escaping in the event of an accident.

Depending on the equipment, different gas regulators can be installed in the vehicle.

If a gas regulator other than the one listed below is installed in the vehicle, the regulator tap on the gas bottle and the gas isolator taps must be closed during the journey.

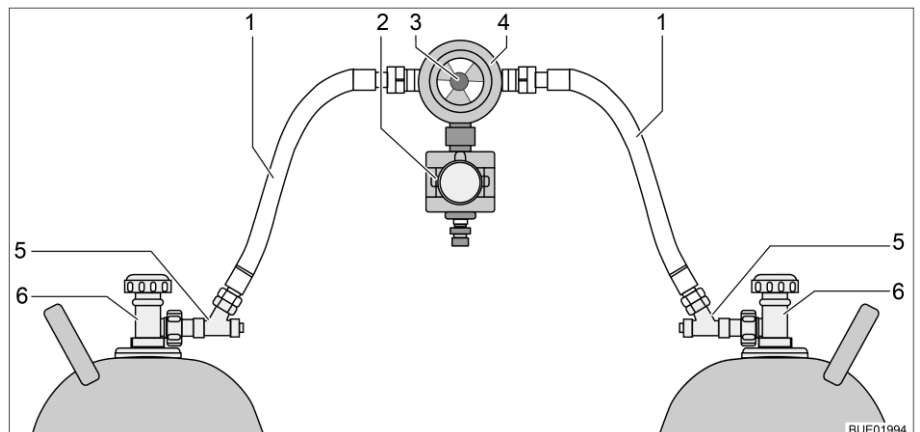

Fig. 20 Gas regulator with CPU and hose break guard

- 1 Gas tube
- 2 Crash protection unit (CPU)
- 3 Knob for manual switching of the gas bottles
- 4 Gas pressure regulator with reversing valve and indicator
- 5 Hose break guard
- 6 Regulator tap on the gas bottle

#### Gas regulator with CPU and hose break guard

If a gas regulator with crash protection unit (Fig. 20,2) and hose break guard (Fig. 20,5) is installed in the vehicle:

The regulator tap on the gas bottle and the gas isolator taps may remain open during the journey. Gas-operated appliances may be on during the journey.



- ▷ If in doubt, get the relevant information from authorised dealers or service centres.

#### 4.14 Snow chains (optional equipment)



- ▷ Only mount snow chains if there is a clearance of at least 50 mm between the tyres and the vehicle body.
- ▷ When using snow chains, the tyres, wheel suspension and steering are subjected to an additional load. When using snow chains, drive slowly (maximum speed 50 km/h) and only on streets which are completely covered with snow. Otherwise the vehicle could be damaged.
- ▷ Observe the fitting instructions issued by the manufacturer of the snow chains.
- ▷ Do not fit snow chains on alloy wheel rims.

Only use suitable snow chains:

Tyre size	Snow chain size
215/70 R 15 C	230
225/75 R 16 C	245

The use of snow chains is subject to the legal regulations of the individual countries.

- Always mount snow chains to the drive wheels.
- After a few metres, check the tension of the snow chains.

#### 4.15 Road safety



- ▶ Check tyre pressure before a journey or every 2 weeks. Wrong tyre pressure causes excessive wear and can lead to damage or even to tyre burst. You can lose control of the vehicle (see section 14.6).
- ▶ Add-on parts can be exposed to adverse conditions (storms, ice, vibrations, etc.) and require close monitoring despite careful design and manufacturing. Therefore, check the tight fit of the add-on parts at certain intervals and before long journeys.

Before commencing the journey, work through the checklist:

Base vehicle

No.	Checks	Checked
1	All vehicle documents are on board	
2	Tyres in proper condition and tyre pressure correct	
3	Vehicle lighting, brake lights and reversing lights function	
4	Oil levels for engine, gearbox and power steering controlled	
5	Coolant and fluid for windscreen washers filled up	
6	Brakes function	
7	Brakes react evenly	
8	When braking, the vehicle remains in the lane	



**Housing body, outside**

No.	Checks	Checked
9	Awning completely retracted	
10	Roof free of snow and ice (in winter)	
11	External connections and lines disconnected and stored away	
12	External supports removed	
13	Fitted supports retracted and fixed in place	
14	Wheel chocks removed and stored away	
15	Entrance step is stored securely or retracted	
16	External flaps closed and locked	
17	Conversion door locked	
18	Overall height of the vehicle including roof rack when loaded measured and noted. Keep the height information close at hand in the driver's cabin	

**Housing body, inside**

19	Windows and skylights closed and locked	
20	Flat screen secured	
21	Satellite antenna retracted (if built in)	
22	Loose parts and add-on parts stored away or fixed in position	
23	Open storage spaces empty	
24	Store sink and drain basin covers securely	
25	Refrigerator door secured	
26	Refrigerator set to 12 V operation (only required in case of manual power selection)	
27	All drawers and flaps closed	
28	All doors secured	
29	All objects removed from pull-down bed	
30	Pull-down bed secured in top end position	
31	Children's seats only mounted on the seats approved for this purpose	
32	Swivel seat locking device for driver's seat and front passenger's seat locked	
33	Shades in the driver's cabin opened and secured	

**Gas system**

34	Gas bottle firmly fixed in the gas bottle compartment so that it is unable to turn	
35	If the gas bottles are not connected to the gas tube, place the protective cap on top	
36	If there is no supplied crash protection unit: Regulator tap on the gas bottle and gas isolator taps are closed	

## Electrical system

No.	Checks	Checked
37	<p>Check the battery voltage/battery capacity (in %) the starter and living area battery (see chapter 9). If the panel indicates that the battery voltage/battery capacity is too low, the respective battery will need to be recharged. Observe the notes and instructions in chapter 9</p> <p> ▷ Commence journey with fully charged starter and living area batteries.</p>	

## Chapter overview

This chapter contains instructions on how to drive the vehicle.

### 5.1 Driving



- ▶ The base vehicle is a commercial vehicle (small truck). Adjust your driving technique accordingly.
- ▶ Before commencing the journey and after short interruptions of the journey, ensure that the entrance step is completely retracted.
- ▶ A seat belt is fitted for each seat which is permitted for travel. Please keep your seat belt fastened during the journey.
- ▶ Never open your seat belts when travelling.
- ▶ Passengers must remain in the seats provided.
- ▶ The doors must remain locked.
- ▶ Avoid braking with a jerk.
- ▶ If a navigation system is used, only change the destination when the vehicle is stationary. Drive to a car park or stop in a safe area when changing the destination.
- ▶ Do not play DVDs using the monitor of the navigation system during the journey.
- ▶ Always switch off outdoor light/awning light during the journey.



- ▷ Drive slowly on poor roads.
- ▷ Take extreme care when driving onto ferries, crossing uneven roads and driving in reverse. Because of the relatively large overhang, larger vehicles might swing out and "touch ground" in unfavourable conditions. This can cause damage to the underbody or to parts fitted there.



- ▷ If an accident occurs as a result of these instructions not being observed, the manufacturer will not be responsible for damages caused.
- ▷ The safety measures stipulated in chapter 3 have to be observed.
- ▷ If a reversing camera is installed in the vehicle, the camera is automatically switched on when driving in reverse gear.

## 5.2 Reversing camera (optional equipment)



Fig. 21 Reversing camera with infrared LEDs

A reversing camera (Fig. 21) is installed in the vehicle.

When it is dark, the infrared LEDs of the reversing camera illuminate the field of view.

If the central multimedia/navigation system has been switched on and reverse is engaged, the reversing camera's image is automatically displayed on the LCD monitor.

In order to display the reversing camera's image on the LCD monitor without engaging reverse: switch on the multimedia/navigation system and activate the camera function via the switch on the display of the MMS system.



- ▷ Further information can be obtained in the manufacturer's instruction manual.

## 5.3 Driving speed



- ▶ The vehicle is equipped with a powerful engine. This means there are sufficient reserves in difficult traffic situations. This high power enables a high maximum speed and requires above-average driving ability.
- ▶ The vehicle provides a large contact surface for wind. A sudden crosswind can be especially dangerous.
- ▶ Uneven or one-sided loading affects road performance.
- ▶ Driving on unknown streets, you may encounter hazardous road conditions and unexpected driving situations. Therefore, in the interest of safety, make sure your driving speed is appropriate to any given driving situation and environment.
- ▶ Adhere to the national legal speed limits.
- ▶ Optional equipment such as skylights, awnings, satellite units, bike racks, or similar, create additional area exposed to the wind. If the vehicle is equipped with such optional equipment, we recommend to drive at an appropriate speed. In case of doubt, please contact the optional equipment's manufacturer.

## 5.4 Brakes



- ▶ Have defects on the braking system immediately remedied by an authorised specialist workshop.

### Before each journey

Before each journey, check by means of a braking test:

- Do the brakes function?
- Do the brakes react evenly?
- Does the vehicle remain in the lane when braking?

## 5.5 Seat belts

### 5.5.1 General

The vehicle is equipped with seat belts in the living area on the seats for which seat belts are compulsory by law. National regulations apply to fastening of seat belts.



- ▶ Fasten your seat belts before the beginning of the journey and keep them fastened during the journey.
- ▶ Do not damage or trap belts. Have damaged seat belts changed by an authorised specialist workshop.
- ▶ Do not alter the belt fixing devices, automatic seat belt winders and the seatbelt locks.
- ▶ Only use one seat belt for **one** adult person.
- ▶ Do not belt in objects together with persons.
- ▶ Seat belts are not sufficient for persons who are less than 150 cm tall. In these cases use additional restraining devices. Observe test certificate.
- ▶ Only attach the child restraint system to seats that are specified for this purpose. We strongly recommend to install child restraint systems preferably in the second row of seats.
- ▶ After an accident, replace the seat belts (have it replaced).
- ▶ During the journey, do not tilt the backrest too far backwards. Otherwise the functionality of the seat belt is no longer guaranteed.

### 5.5.2 Fastening the seat belts correctly



- ▶ Do not twist the belt. The belt must be positioned smoothly against the body.
- ▶ When fastening the seat belt, adopt the correct sitting position.

The seat belt is correctly fastened when the lap belt passes below your stomach and across the hip bone. The shoulder belt must pass across the chest and shoulder (not across your neck). The belt must always be taut against your body. Any bulky or padded clothing should therefore be removed before you start your journey.

## 5.6 Child restraint systems



- ▶ When travelling, secure children under 13 years of age that are smaller than 150 cm, with a suitable and officially approved child restraint system.
- ▶ Only attach the child restraint system to seats that are specified for this purpose. We strongly recommend to install child restraint systems preferably in the second row of seats.
- ▶ Fasten the children's seat belts before commencing the journey and make sure that their seat belts are kept fastened during the journey.
- ▶ Use a rear-facing child restraint system ("reboard system") only when the front and side air bags on the passenger side are switched off. Observe the separate operating instructions of the chassis manufacturer and the warning notices in the vehicle. If no rear-facing child restraint system is in use, switch the airbags back on again.
- ▶ Never use rearward-facing child restraint system on a seat with activated front airbag. This may lead to death or to serious injuries in children.

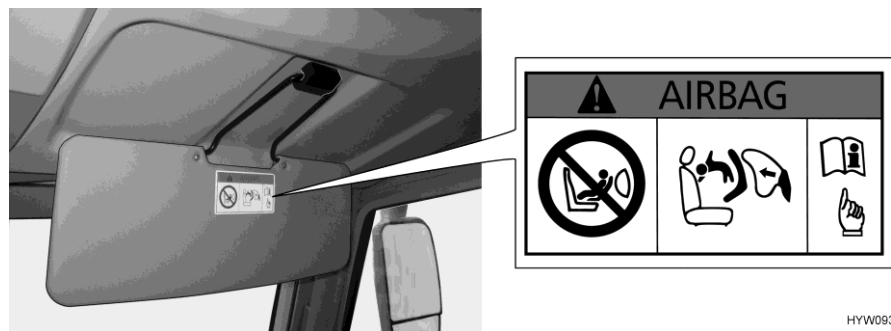

HYW09354

Fig. 22 Warning notice on child restraint system (front passenger's seat sun visor)

### Rearward-facing child restraint systems on the front passenger's seat

The front passenger's seat is equipped with an airbag. In the event of an accident, the triggered airbag may cause serious injuries in the child or to its death. A warning notice (Fig. 22) depicting this hazard is attached to both sides of the sun visor.

Refer to the instruction manual of the base vehicle for any information regarding the deactivation of the front passenger airbag.

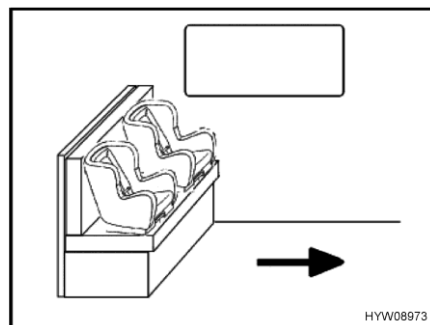

HYW08973

Fig. 23 Child seats on bench

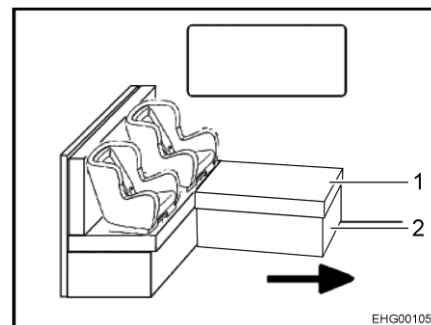

EHG00105

Fig. 24 Child seats on L-shaped bench

**Child restraint systems in the living area**

The arrow in Fig. 23 and Fig. 24 shows the direction of travel.

On the L-shaped bench, the back cushion on the side wall must be removed when a child seat is fitted.

- Lower the table.
- Remove the cushion (Fig. 24,1) if necessary.
- Fold the chest frame (Fig. 24,2) if necessary.

Child restraint systems are divided into five classes:

Class	Body weight	Approximate age
0	Up to 10 kg	Up to 9 months
0+	Up to 13 kg	Up to 18 months
I	9 kg to 18 kg	9 months to 4 years
II	15 kg to 25 kg	3 years to 7 ½ years
III	22 kg to 36 kg	6 years to 12 years

The following table shows, which child restraint systems can be used on which seats.

Class	Front passenger's seat		Second row of seats (in the opposite direction to travel, if present)	Third row of seats (row of seats in the direction of travel)
	Airbags active	Airbags not active		
0, 0+	X	U	X	U**
I	U*	U	X	U**
II	U	U	X	U**
III	U	U	X	U**
U:	Suitable for "universal" restraint systems which are authorised for this weight class			
X:	Seat is not suitable for children in this weight class			
*	Not authorised if used in a child restraint system directed towards the rear (Reboard system)			
**	Only possible in the respective seat if the distance between the seat and the table is large enough or if the table has been removed			

## 5.7 ISOFIX child safety seat mounting system (optional equipment)

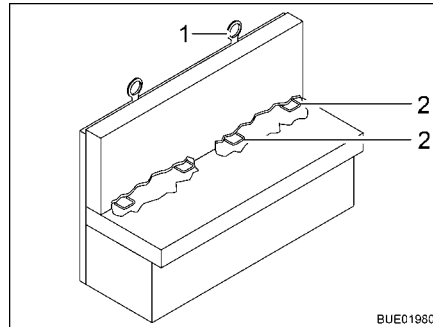

Fig. 25 ISOFIX child safety seat mounting system

If the vehicle is equipped with the ISOFIX child safety seat mounting system, the vehicle seats suitable for it are marked with the ISOFIX symbol. These vehicle seats have retaining brackets (Fig. 25,2) and another anchorage point at the top of the seat backrest (Top Tether) (Fig. 25,1). Use child restraint system suitable for ISOFIX. The child restraint systems possess connectors which are latched to the retaining brackets of the vehicle seat.

The bench with the special equipment ISOFIX child safety seat mounting system is suitable for child seats with ISOFIX system, which are specially authorised for this vehicle type according to the standard ECE-R 44.

Child restraint systems of the groups 0, 0+, and 1 with ISOFIX child safety seat mounting system can be fastened at the ISOFIX anchorage points on the bench.

### Fastening a child seat:

- Push the connectors of the child seat into the ISOFIX anchorage points until they engage audibly.
- By pulling the child seat, check whether both sides have engaged correctly.
- If possible, fasten the child seat at the Top Tether (Fig. 25,1).



- ▷ Also observe the instruction manual of the child restraint system manufacturer.



## 5.8 Pilot seats for the driver's and front passenger's seats



- ▶ Before commencing the journey, rotate all swivel seats in the direction of travel and lock in position.
- ▶ The seats must remain fixed in position during the journey and are not to be rotated.



- ▷ Before rotating the seats in the pitched vehicle, always apply the handbrake.
- ▷ Push the driver's seat into the central position before rotating it. If the driver's seat is in the very back or in the very front, there is a risk of colliding with the handbrake lever or the seating group when rotating the driver's seat.



- ▷ The driver's seat and the front passenger's seat are part of the base vehicle. The adjustment of the seats is described in the instruction manual of the base vehicle.
- ▷ The possibilities of seat adjustment differ according to the model and equipment variants.

## 5.9 Additional seat with folding table (depending on model) (optional equipment)

Depending on the equipment, the divan can be converted into an additional seat. This seat is equipped with a seat belt and can be used during the journey. The front part of the divan can be converted into a folding table.

If the divan has not been converted into the additional seat, it is not permitted to use it during the journey.



Fig. 26 Divan

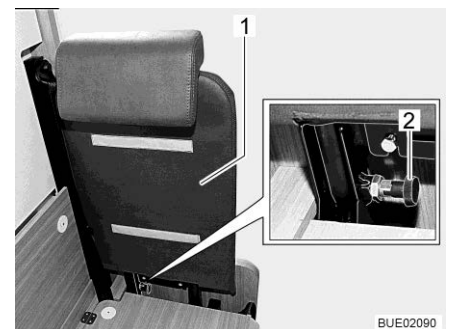

Fig. 27 Backrest

### Converting the seat:

- Remove the covering cushion (Fig. 26,1), both seat cushions, and the back cushion from the divan.
- Insert the included backrest (Fig. 27,1) into the divan's side wall. When doing this, make sure that the catch in the knob (Fig. 27,2) engages.

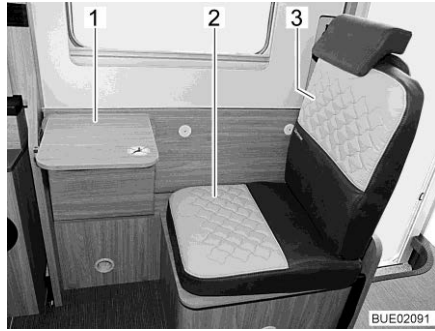

Fig. 28 Additional seat with folding table

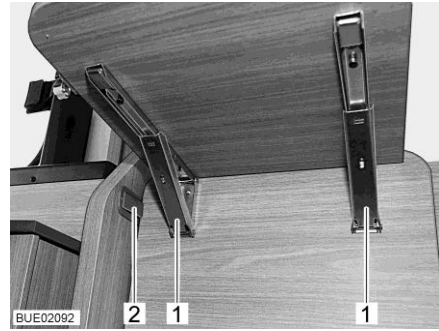

Fig. 29 Catches on the folding table

- Attach the included seat cushion (Fig. 28,2) and the back cushion (Fig. 28,3).
- Swing the divan's front part upwards until it engages in the plastic catch (Fig. 29,2).
- Folding the table top away: Unlock both catches (Fig. 29,1) and swing table top (Fig. 28,1) downwards.



- ▷ Adjust the headrest and put on the seat belt before setting off.

### 5.10 Additional seat secured by belts (partially optional equipment)

Depending on the model and the ground plan, the vehicle can be equipped with an additional seat secured by belt. This seat is fitted in the opposite direction to travel on the chest frame behind the front passenger's seat.



Fig. 30 Chest frame

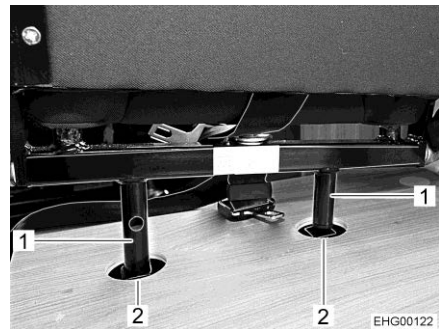

Fig. 31 Bars (inserted)

Mounting the seat:

- Insert both bars (Fig. 31,1) of the seat in the holes (Fig. 31,2) the chest frame (Fig. 30).



Fig. 32 Chest frame (open)

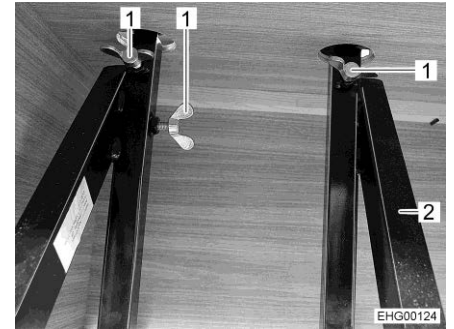

Fig. 33 Wing screws

- Fold flap (Fig. 32,1) on the chest frame downwards.
- Tighten the three wing screws (Fig. 33,1) on the rods (Fig. 33,2) in the chest frame.



Fig. 34 Retaining belt

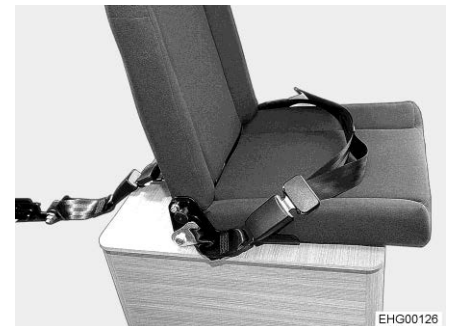

Fig. 35 Seat (completely fitted)

- Plug retaining belt (Fig. 34,1) into the seatbelt lock. The additional seat is now completely fitted (Fig. 35).

### 5.11 Seat heater (optional equipment)



- ▷ The seat heater only works when the ignition is switched on.

Depending on equipment levels, the driver's seat and the front passenger's seat may have a 2-level seat heater.

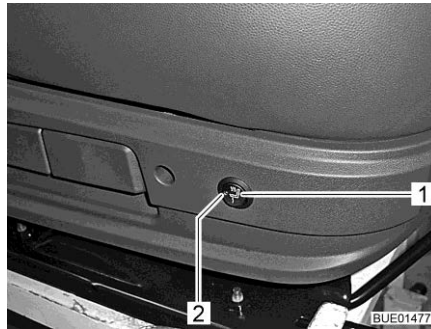

Fig. 36 Switch for seat heater

#### Switching on the seat heater:

- Press the switch (Fig. 36,1) at the back on the left side of the seat console.
  - For minimal heating: Press the switch so that it is in the down position.
  - For the highest heat level: Press the switch so that it is in the up position.

The LED (Fig. 36,2) comes on when the seat heater is in use.

#### Switching off the seat heater:

- Set switch (Fig. 36,1) to the middle position. The LED goes out.

### 5.12 Headrests

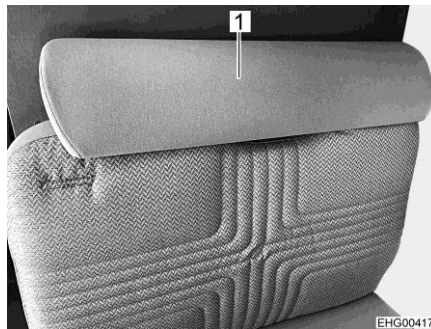

Fig. 37 Bench headrest, one-part

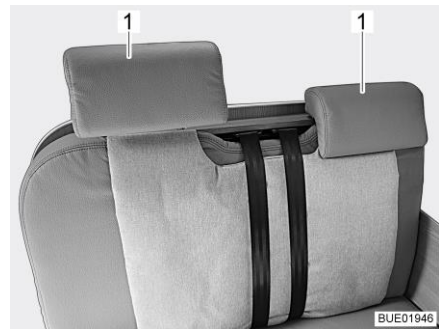

Fig. 38 Bench headrest, two-part

Before commencing the journey, adjust the headrest (Fig. 37,1 or Fig. 38,1) so that the back of the head is supported at approximately ear height.

Push the headrests upwards or downwards by hand.

### 5.13 Seating arrangement



- ▶ During the journey, persons are only to sit on the permitted seats. The authorised number of seats is stipulated in the vehicle documents.
- ▶ During the journey sitting on the divans is not permitted.
- ▶ Seat belts must be worn by all passengers.



Fig. 39 Symbol "Do not use seat during the journey"

Seats which may not be used during the journey are equipped with the depicted sticker (Fig. 39).

### 5.14 Roman shade in the driver's cabin

#### 5.14.1 Pleated Roman shades



- ▶ During the journey, the Roman shades for the windscreen, driver's window and the front passenger's window respectively must be completely removed.



Fig. 40 Pleated Roman shades

#### Removing the pleated shade:

- Open the snap fasteners (Fig. 40,1), loosen the magnetic strips and detach the pleated shade from the window (shown here on the passenger window).
- Stow away the pleated shades in the living area.

### 5.14.2 Roman shades, Remis (partially optional equipment)



- ▶ During the journey, the Roman shades for the windscreen, driver's window and front passenger's window must be open, in a fixed position and secured.

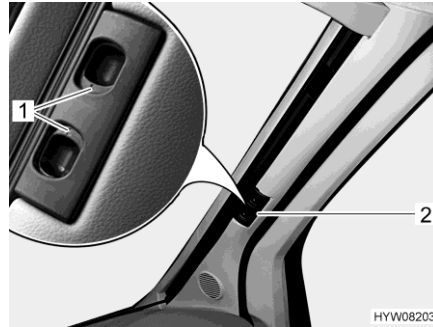

Fig. 41 Roman shade for the windscreen

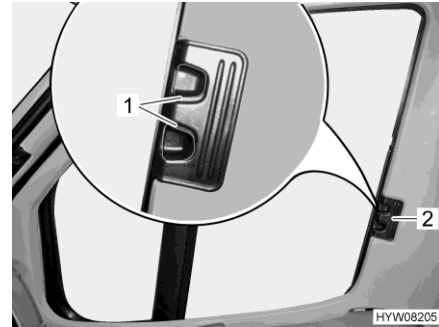

Fig. 42 Roman shade for the driver's / front passenger's window

- Securing:
- Use the handle (Fig. 41,2) to pull the two halves of the Roman shade for the windscreen outwards as far as they will go. When doing so, move the handle horizontally in the direction of the locking recess.
  - Allow the release handles (Fig. 41,1) to engage.
  - Use handle (Fig. 42,2) to push in the Roman shades for the driver's and passenger's window as far as possible.
  - Allow the release handles (Fig. 42,1) to engage.

### 5.15 Refuelling



- ▶ All gas-operated devices must be switched off for refuelling (heater, cooker, oven, grill, refrigerator - depending on the equipment). Danger of explosion!



- ▷ The fuel filler neck is part of the base vehicle.
- ▷ The fuel filler neck is labelled with the word "Diesel".

Refer to the instruction manual for the base vehicle for the position of the fuel filler neck.

### 5.16 Topping up AdBlue®



- ▶ Store AdBlue® out of the reach of children. Do not store any AdBlue® containers in the vehicle.
- ▶ Before topping up AdBlue®, switch off all fitted appliances (such as heater, boiler and cooker).



- ▷ If the AdBlue® tank is empty, you cannot start the vehicle. If you have driven until the AdBlue® tank has been emptied, the tank must be filled with at least 3.8 litres.
- ▷ Do not dilute AdBlue® with water.
- ▷ Do not top the fuel tank up with AdBlue®.



Fig. 43 Warning signs for AdBlue®

The base vehicle is equipped with an emission control system that operates with the additive AdBlue®. AdBlue® can be purchased in containers of various sizes or at petrol stations that have an AdBlue® dispenser system.

The additional tank for AdBlue® has a capacity of 15 litres. Audible and visual signals indicate when the reserve has been reached. The first alarm appears when you can still drive 2400 km.

The AdBlue®- tank's filler neck is located underneath the fuel tank's filler neck. The filler neck is closed with a blue lid.





Fig. 44 Filler neck for AdBlue® (Fiat)

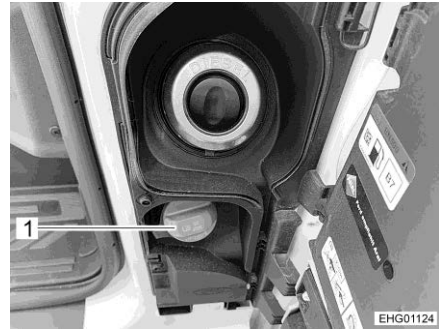

Fig. 45 Filler neck for AdBlue® (Ford)

## Topping up AdBlue®:

- Turn blue lid (Fig. 44,1 or Fig. 45,1) in an anticlockwise direction and remove it.
- Top AdBlue® up from container or dispenser system.
- Place blue lid on filler neck and turn in a clockwise direction as far as it will go.
- Immediately remove any liquid that has possible been spilled around the filler neck with a moist cloth.
- Before the next start of the engine, switch ignition on for approx. 10 seconds **without** starting the engine while doing so.



- ▷ Do not dispose of the AdBlue® containers in the domestic waste. Dispose of the empty containers in accordance with the national directives or return them to the point of sale.



- ▷ Further information can be found in the instruction manual of the base vehicle.



## Chapter overview

This chapter contains instructions on how to pitch the vehicle at the campsite.



- ▷ Pitch the vehicle so that it is as horizontal as possible. Use ramps where necessary. Otherwise, the water from the shower tray will not be able to drain properly.
- ▷ Secure the vehicle to prevent it from rolling.
- ▷ Animals (especially mice) can cause great damage to the interior of the vehicle. To prevent this from happening, regularly check the vehicle for damages or animal traces after pitching.

### 6.1 Handbrake

Firmly apply the handbrake when parking the vehicle.

### 6.2 Entrance step



- ▷ Observe the instructions in section 4.7.

In order to exit the vehicle, first fully extend the electrically operated entrance step. Observe the indicator lamp on the dashboard.

### 6.3 Ramps



- ▷ Ramps are not included in the scope of delivery. Different models are available at the accessories shop.

To enable the vehicle to be parked on the level, ramps can be used for height compensation when the vehicle is parked on a hill or on uneven ground.

### 6.4 Wheel chocks

When parking the vehicle on slopes or inclines use the wheel chocks.

If the maximum permissible gross weight of the vehicle exceeds 4 tonnes, wheel chocks must be used when parking on gradients. The wheel chocks are provided as standard for vehicles which have a maximum permissible gross weight exceeding 4 t.

## 6.5 Supports

### 6.5.1 General instructions



- ▶ The steady legs must not be used to jack up the vehicle in order to work beneath it, e.g. to change a wheel or carry out maintenance work.
- ▶ Whilst the vehicle is in a jacked up position, persons must not lie down under it.



- ▷ Always apply the handbrake before extending the steady legs.
- ▷ When pitching the vehicle, ensure that the supports are evenly loaded.
- ▷ Before driving away, wind up the supports as far as they can go, fully retract and secure them.



- ▷ When the ground is soft, place a pad or block under the supports in order to prevent the vehicle from sinking into the ground.
- ▷ Pitch the vehicle so that it is as horizontal as possible. Otherwise, the water from the shower tray will not be able to drain properly.

### 6.5.2 Steady legs, rear (AL-KO) (optional equipment)

In order to ensure their correct function, clean and grease the interior tubes of the steady legs regularly.

The length of the steady legs can be adjusted according to the model.

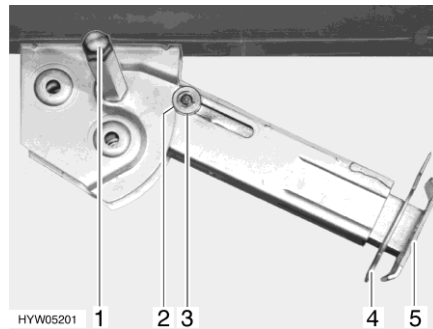

Fig. 46 Steady leg

- Extending:**
- Place the socket spanner on the hexagon nut (Fig. 46,1) and rotate until the steady leg is in a perpendicular downward position.
  - Remove the splint (Fig. 46,4) out of the support foot extension (Fig. 46,5).
  - Extend the support foot extension until it has reached the required length.
  - Insert the splint in the support foot extension.
  - Rotate the hexagonal nut until the steady leg rests completely on the ground and the vehicle is in a horizontal position.

- Retracting:**
- Place the socket spanner on the hexagon nut (Fig. 46,1) and rotate until the steady leg is clear of the ground.
  - Remove the splint (Fig. 46,4) out of the support foot extension (Fig. 46,5).
  - Push in the support foot extension (Fig. 46,5) and insert the splint (Fig. 46,4) in the drilled hole in the support foot extension.
  - Rotate the hexagonal nut (Fig. 46,1) with the socket spanner until the steady leg has swung upwards and the guide disc (Fig. 46,3) has completely retracted into the notch (Fig. 46,2).



- ▷ Before commencing the journey, observe the following: Are all steady legs and support foot extensions retracted completely and secured with the splint?

## 6.6 230 V connection

The vehicle can be connected to a 230 V power supply (see chapter 9).

## 6.7 Refrigerator



- ▶ If the refrigerator is set to 12 V operation, it will constantly consume current. Therefore, switch over to gas operation when the vehicle engine is **not** running, and the vehicle is **not** connected to the 230 V power supply.

In the case of appliances with automatic power selection, the 12 V operation of the refrigerator will only be selected in the automatic mode when the vehicle engine is running.

In the case of appliances with manual power selection: When the vehicle engine is switched off switch the refrigerator to 230 V operation or gas operation.

## 6.8 Satellite unit (optional equipment)



- ▶ Before commencing the journey, ensure that the antenna is in park position. Danger of accidents!



- ▷ Move the antenna into parking position in the event of strong wind (above 80 km/h).



- ▷ The vehicle must be still during the satellite search. Do not walk through the vehicle.
- ▷ Satellite reception is only possible, when the antenna is positioned in direct line of sight of the chosen satellite and the view is not blocked in any way.



- ▷ Further information can be obtained in the device manufacturer's instruction manual.

### 6.8.1 Satellite unit with automatic antenna alignment (Teleco)

The satellite unit is equipped with an automatic advance unit. This automatic advance unit ensures that the antenna is aligned precisely.

When switching on the unit, the antenna is extended automatically. When switching off the unit or when starting the vehicle engine, the antenna is retracted automatically.

When the desired TV programme is chosen, the corresponding satellite is selected and aimed at automatically.

The satellite unit is operated via remote control. Optionally, a simplified remote control is available.



- 1 Television on/off button
- 2 AUTO button (advance unit and television on/off)
- 3 INPUT button (selection of the signal source)
- 4 Programme selection buttons

Fig. 47 Remote control

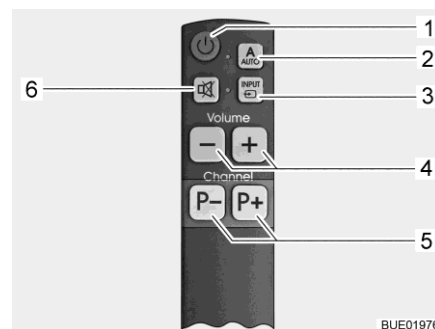

- 1 Television on/off button
- 2 AUTO button (advance unit and television on/off)
- 3 INPUT button (selection of the signal source)
- 4 Volume buttons
- 5 Programme selection buttons
- 6 Mute button

Fig. 48 Simplified remote control (optional)

#### Switching on the unit:

- Press the AUTO button (Fig. 47,2 or Fig. 48,2) for 1 second. Thus, the television and the advance unit are switched on.

If the antenna had been retracted, it will now extend to operating position. The antenna then automatically starts searching for the satellite suitable for the set TV programme.

When the unit finds the satellite, the TV programme appears automatically.

- Choosing a TV programme:**
- Press the programme selection buttons (Fig. 47,4 or Fig. 48,5) until the desired TV programme has been selected.
- The antenna automatically searches for the suitable satellite.  
When the unit finds the satellite, the TV programme appears automatically.
- Choosing the signal source:**
- Press the INPUT button (Fig. 47,3 or Fig. 48,3) repeatedly until the desired signal source has been selected.
  - To return to the satellite channels display, press the INPUT button (Fig. 47,3 or Fig. 48,3) repeatedly until the signal source DVB-S2 has been selected.
- Switching off the unit:**
- Press the AUTO button (Fig. 47,2 or Fig. 48,2).
- The antenna automatically moves into parking position. When reaching the parking position, this is displayed on the screen.  
The television and advance unit switch off after a few seconds.
- Operating the unit without using the antenna:**
- Press the Television on/off button (Fig. 47,1 or Fig. 48,1). The advance unit is not switched on, the antenna remains in parking position.
  - Press the INPUT button (Fig. 47,3 or Fig. 48,3) repeatedly until the desired signal source (e.g. DVD) has been selected.
  - Press the Television on/off button (Fig. 47,1 or Fig. 48,1) to switch the television off.

### 6.8.2 Satellite unit with automatic antenna alignment (Oyster Premium)



- ▷ In the event of a longer stationary period, disconnect the flat screen from the power supply with the flip switch to prevent the living area battery from getting discharged.



- ▷ If the location is adjusted with the help of the list of countries, the satellite search will be accelerated.
- ▷ If the antenna has been retracted by switching on the ignition, it is required to restart the system by switching it off and on.
- ▷ The reception of DVB-T/T2 channels (digital terrestrial television) is only possible if there is a DVB-T/T2 antenna present.

The antenna will automatically be aligned with a pre adjusted satellite if the receiver system is within the reach of this satellite.

When switching on the unit, the antenna is extended automatically. When switching off the unit or when starting the vehicle engine, the antenna is retracted automatically.

When the desired TV programme is chosen, the corresponding satellite is selected and aimed at automatically.

The remote control's basic operating functions are listed here; refer to the manufacturer's separate instruction manual for a full description.

The system is equipped in the factory with list of standard channels as well as lists of favourites. You can change or add to these standard lists manually as desired.

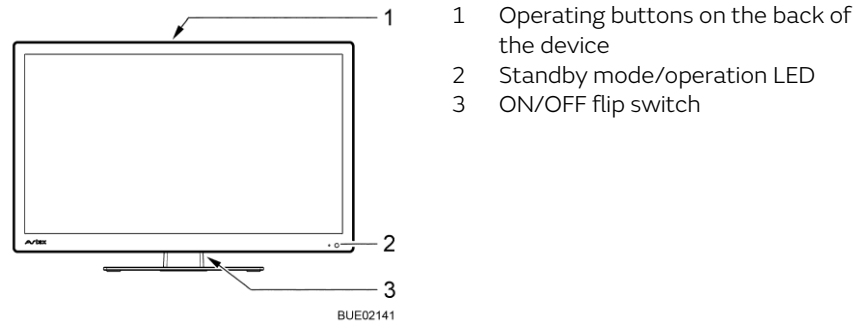

Fig. 49 Operation on the flat screen

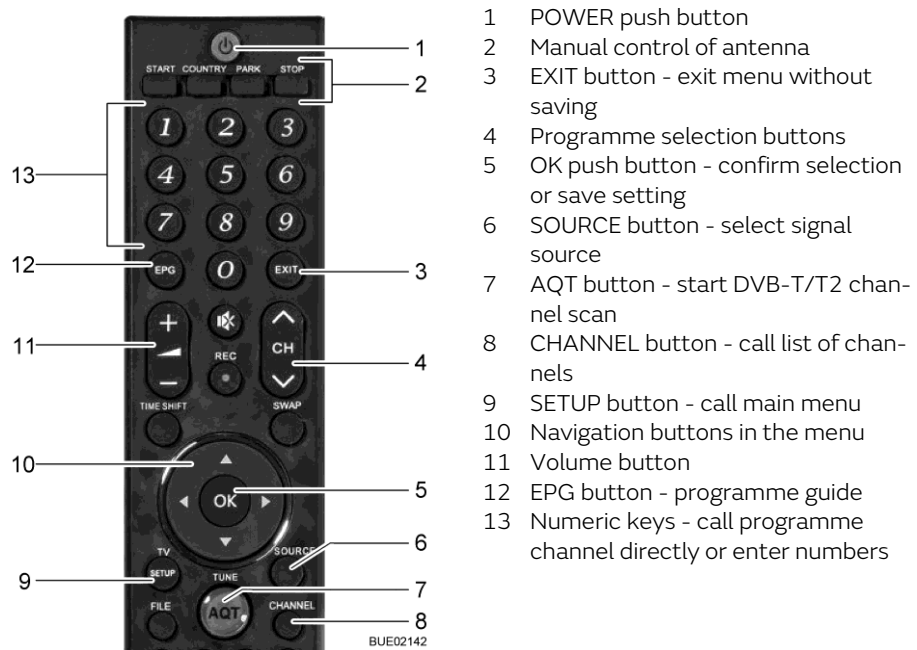

Fig. 50 Remote control

**Switching on the unit:**

- Set flip switch (Fig. 49,3) on the flat screen's back to ON. The system changes to standby mode. The LED (Fig. 49,2) is lit red.

Further operation is performed via the remote control and the indicators displayed on the flat screen.

- Press the POWER button (Fig. 50,1) on the remote control. The LED (Fig. 49,2) is lit blue.

**Choosing a TV programme:**

- Press the programme selection buttons (Fig. 50,4 or Fig. 50,13) until the desired TV programme has been selected.

The antenna automatically searches for the suitable satellite.

When the unit finds the satellite, the TV programme appears automatically.

**Choosing the signal source:**

- Press the SOURCE button (Fig. 50,6) repeatedly until the desired signal source has been selected.
- To return to the satellite channels display, press the SOURCE button repeatedly until the signal source DVB-S has been selected.

Operating the unit without using the antenna:

- Press the PARK button (Fig. 50,2). The antenna moves into parking position.
- Press the SOURCE button (Fig. 50,6) repeatedly until the desired signal source (e.g. DVD) has been selected.

Switching off the unit:

- Press the POWER button (Fig. 50,1) on the remote control. The system changes to standby mode. The LED (Fig. 49,2) is lit red.
- Set flip switch (Fig. 49,3) on the flat screen's back to OFF.

The system is disconnected from the power supply.

The antenna automatically moves into parking position.

## 6.9 Awning (optional equipment)



- ▷ Retract the awning in strong wind, rain or snow.
- ▷ In the case of light rain, shorten one of the support legs so that water can run off.
- ▷ Only retract the awning when the fabric is dry. When the awning must be retracted while the fabric is still wet: Extend the awning as soon as possible, in order to dry out the fabric.
- ▷ Before retracting, remove leaves and coarse dirt from the awning.



- ▷ Only use the awning for protection against the sun.
- ▷ Also read the manufacturer's instruction manual.

**Advantages of the awning**

The advantages of an awning are:

- The awning provides shade.
- The awning creates a covered vestibule and thus expands the space.
- The vehicle thus becomes more homelike.
- The integrated LED lighting (optional equipment) provides additional light.



Fig. 51 Awning

Putting up the awning:

- Use the manual crank to open up the awning (Fig. 51,1).
- Set up the brackets (Fig. 51,2) when the awning is open.





## Chapter overview

This chapter contains instructions about living in the vehicle.

### 7.1 Doors



- ▶ Only drive with locked doors.



- ▷ Locking the doors can prevent them from opening of their own accord, e.g. during an accident.
- ▷ Locked doors also prevent forced entry, e.g. when waiting at traffic lights. However, in an emergency, locked doors make it more difficult for helpers to enter the vehicle.
- ▷ When leaving the vehicle, always lock the doors.
- ▷ The locks on the vehicle doors are a part of the base vehicle. The opening and closing of the vehicle doors is described in the instruction manual of the base vehicle.

#### 7.1.1 Central locking system, driver's cabin and conversion door (optional equipment)



- ▷ The central locking system locks the driver's door, the passenger's door and the conversion entrance door of the body.
- ▷ The central locking system has no function, if the battery cut-off switch on the transformer/rectifier is switched off.

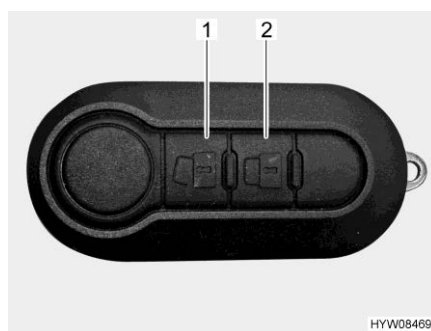



Fig. 52 Remote control for central locking system (2 buttons)

Unlocking doors: ■ Press the  button (Fig. 52,1) once briefly. The door locks are unlatched.

Locking doors: ■ Press the  button (Fig. 52,2) once briefly. The door locks are locked.

### Multifunctional remote control, central locking system (optional equipment)

Depending on the equipment, the vehicle will be equipped with a remote control with 3 buttons.

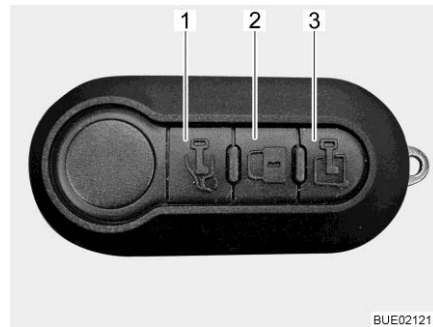



Fig. 53 Multifunctional remote control (3 buttons)

Unlocking driver's door:

- Press the  button (Fig. 53,1) once briefly. The driver's door is unlocked.

Unlocking conversion door:

- Press the  button (Fig. 53,3) once briefly. The conversion door is unlocked.

Locking all doors:

- Press the  button (Fig. 53,2) once briefly. All doors have been locked. If one or more doors have not been correctly closed, the direction indicators will be flashing rapidly.



- ▷ Further information can be found in the instruction manual of the base vehicle.

### 7.1.2 Conversion door, outside

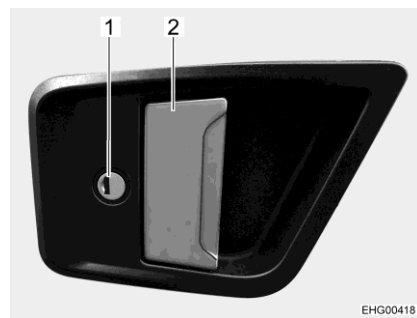

Fig. 54 Door lock (conversion door, outside)

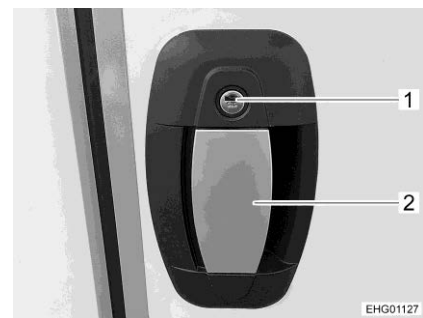

Fig. 55 Door lock, variant (conversion door, outside)

Opening:

- Insert the key into locking cylinder (Fig. 54,1 or Fig. 55,1) and turn until the door lock is unlatched.
- Return the key to the central position and remove it.
- Pull on the door handle (Fig. 54,2 or Fig. 55,2). The door is open.

Locking:

- Insert the key into locking cylinder (Fig. 54,1 or Fig. 55,1) and turn until the door lock is engaged.
- Return the key to the central position and remove it.

### 7.1.3 Conversion door, inside

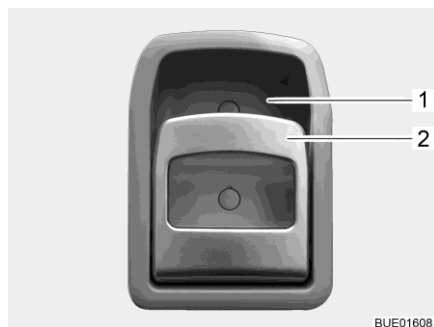

Fig. 56 Door lock (conversion door, inside)



Fig. 57 Door lock, variant (conversion door, inside)

**Opening:** ■ Pull by the handle (Fig. 56,2 or Fig. 57,1). The door lock is unlatched or opened.

**Locking:** ■ Press the upper part of the handle (Fig. 56,2) in the direction of the recessed handle (Fig. 56,1). The door lock is locked.

**Or:**

Press black area (with padlock icon) (Fig. 57,2) in until the red area (Fig. 57,3) becomes visible. The door lock is locked.

### 7.1.4 Window conversion door (partially optional equipment)

The conversion door window is fitted with a Roman shade.

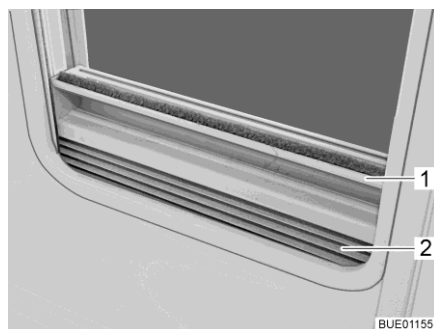

Fig. 58 Roman shade

**Closing:** ■ Grip the Roman shade (Fig. 58,2) in the middle of the holding bar (Fig. 58,1), pull it upwards and then release it at the desired height. The Roman shade will stay at this height.

**Opening:** ■ Grip the Roman shade in the middle of the holding bar and push it down.

### 7.1.5 Folding insect screen on the conversion door (partially optional equipment)



- ▷ Open the insect screen completely before closing the conversion door.



Fig. 59 Insect screen

- Closing:**
- Pull out the insect screen completely by the bar (Fig. 59,1).
- Opening:**
- Push the insect screen into its initial position by the bar (Fig. 59,1).

## 7.2 External flaps



- ▷ Before commencing the journey, close all external flaps and lock them.
- ▷ To open and close the external flap, open or close all locks that are fitted to the external flap.



- ▷ When leaving the vehicle, close all external flaps.

The external flaps fitted to the vehicle are all fitted with identical locking cylinders. Therefore, all locks can be opened with a single key.

### 7.2.1 Flap lock with recessed handle



- ▷ To open the external flap, pull all the lock handles fitted to that particular external flap at the same time.

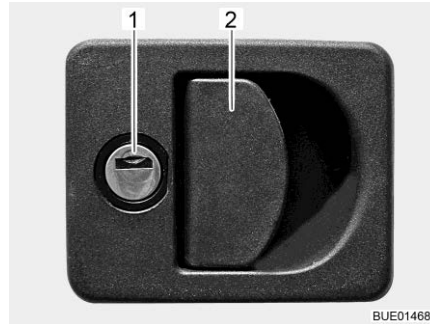

- 1 Locking cylinder  
2 Lock handle

Fig. 60 Flap lock with recessed handle

- Opening:**
- Insert key into locking cylinder (Fig. 60,1) and turn a quarter turn. The flap lock is unlatched.
  - Remove the key.
  - Pull on the lock handle (Fig. 60,2). The external flap is open.
- Closing:**
- Firmly close the external flap.
  - Insert key into locking cylinder and turn a quarter turn. The flap lock is locked.
  - Remove the key.

### 7.2.2 Garage flap emergency release

The garage flap can be opened from the interior using the emergency release. The emergency release is even possible if the garage flap has been locked with the key.

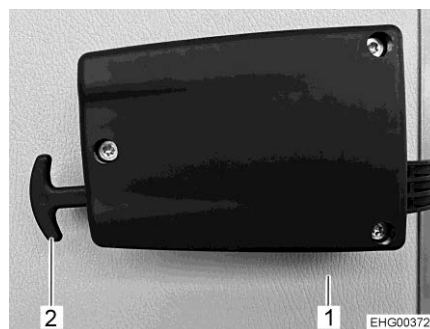

Fig. 61 Garage flap emergency release

- Unlocking the garage flap:**
- Pull both handles of the emergency release (Fig. 61,2).
  - Push the garage flap (Fig. 61,1) outwards.

### 7.2.3 Flap lock with push button

Depending on the flap size the service flap is equipped with one or two lockable push-button locks.

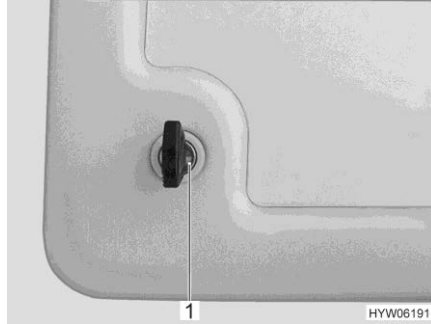

Fig. 62 Service flap push-button lock



Fig. 63 Service flap push-button lock (alternative)

- Opening:**
- Insert the key into locking cylinder of the lockable push-button lock (Fig. 62,1 or Fig. 63,1) and turn a quarter turn. The push-button lock is unlatched.
  - Remove the key.
  - If equipped, unlock the second lockable push-button lock as well.
  - Press the two push buttons (Fig. 63,2) of the push-button locks simultaneously with the thumb and open the service flap.
- Closing:**
- Close the service flap and press it shut. The push-button locks are now engaged but not locked.
  - Insert the key into locking cylinder of the lockable push-button lock (Fig. 62,1 or Fig. 63,1) and turn a quarter turn. The push-button lock is locked.
  - Remove the key.
  - If equipped, lock the second lockable push-button lock as well.

### 7.2.4 Service unit flap lock



Fig. 64 Flap lock, locked



Fig. 65 Flap lock, unlocked

- Opening:**
- Insert the key into the locking cylinder and turn until the red ring (Fig. 65,1) is visible. The flap lock is unlatched.
  - Remove the key.
  - Turn the handle half a turn in an anticlockwise direction until the red area (Fig. 65,2) is visible. The lock is open.
- Closing:**
- Close flap.
  - Turn the handle half a turn in a clockwise direction until the red area (Fig. 65,2) is no longer visible.
  - Insert the key into the locking cylinder and turn until the red ring (Fig. 65,1) is no longer visible.
  - Remove the key.

### 7.2.5 Flap lock, square



Fig. 66 Flap lock, square

- 1 Cap
- 2 Locking cylinder

- Opening:**
- Open the cap (Fig. 66,1).
  - Insert key into locking cylinder (Fig. 66,2) and turn a quarter turn.
  - Remove the key.
- Closing:**
- Firmly close the external flap.
  - Insert key into locking cylinder and turn a quarter turn.
  - Remove the key.
  - Close the cap.

### 7.3 Furniture flaps



- ▷ Before commencing the journey, close all furniture flaps and inner doors and lock them.
- ▷ The furniture flaps shown in this section are examples. Depending on the model, the locks and handles on the furniture flaps may differ to those displayed here.

#### 7.3.1 Furniture flaps with push button

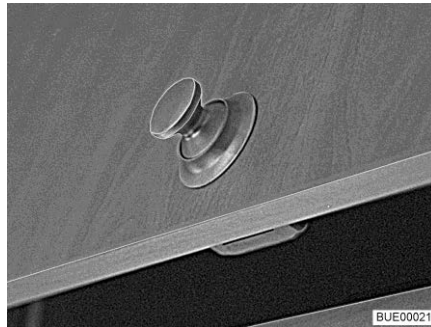

Fig. 67 Furniture flap with push button (round) (round)

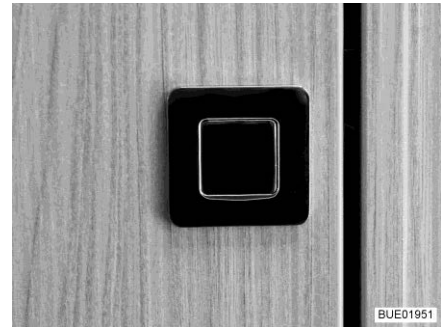

Fig. 68 Furniture flap with push button (square)

- Opening:**
- Press inner part of the lock. The push button (Fig. 67 or Fig. 68) jumps out.
  - Hold push button and open furniture flap.
- Closing:**
- Press furniture flap shut.
  - Press push button in until it locks. The furniture flap is closed correctly when the fastener locks into place.

#### 7.3.2 Furniture flaps with handle and release

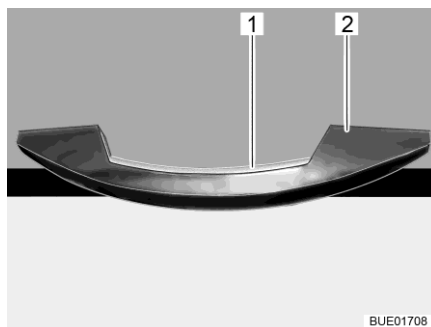

Fig. 69 Handle with unlocking bar (example)

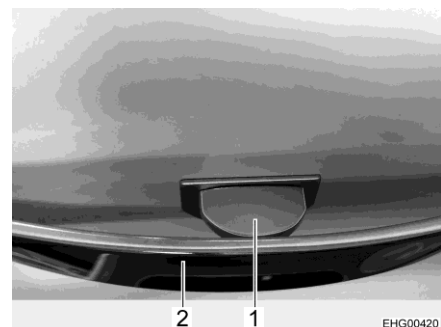

Fig. 70 Handle with release tab

- Opening:**
- Press and hold the unlocking bar (Fig. 69,1) or release tab (Fig. 70,1).
  - Pull the handle (Fig. 69,2 or Fig. 70,2) until the furniture flap is open.
- Closing:**
- Press the furniture flap down until you can feel the flap hinge close and hear the lock snap into place.



## 7.4 Floor compartment cover

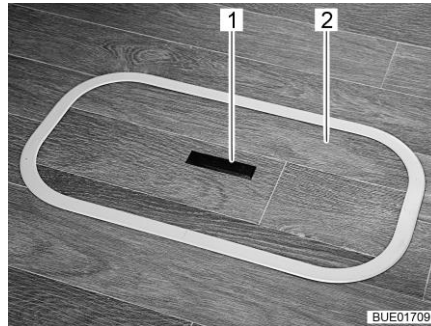

Fig. 71 Floor compartment cover  
(handle recessed)

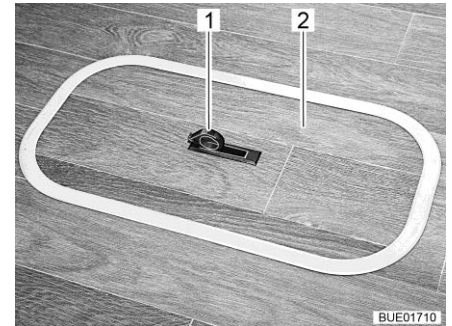

Fig. 72 Floor compartment cover  
(handle swung out)

- Opening:**
- Push one side of the grip plate (Fig. 71,1) downwards. The handle (Fig. 72,1) swivels upwards.
  - Remove the cover (Fig. 71,2 or Fig. 72,2) upwards.
- Closing:**
- Insert the cover in the frame on the floor.
  - Swivel handle downwards.

## 7.5 Rotating seats



- ▶ Before commencing the journey, rotate all swivel seats in the direction of travel and lock in position. During the journey, the swivel seats must remain locked in place in the direction of travel.



- ▷ Push the driver's seat into the central position before rotating it. If the driver's seat is in the very back or in the very front, there is a risk of colliding with the handbrake lever or the seating group when rotating the driver's seat.



- ▷ The driver's seat and the front passenger's seat are part of the base vehicle. The adjustment of the seats is described in the instruction manual of the base vehicle.

- Rotating:**
- Push both armrests at the driver's/front passenger's seat upward.
  - Push the driver's seat / front passenger's seat into the central position.
- The seats can only be locked in position in the direction of travel.

## 7.6 Light switch

### 7.6.1 Entrance area



▷ The light switches shown in this section are examples. Depending on the model, the type and allocation of the light switches may differ to those displayed here.

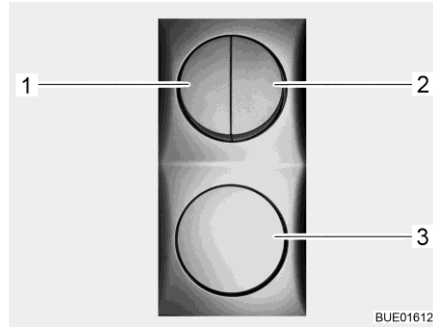

Fig. 73 Light switch



Fig. 74 Awning light

The entrance area has light switches (Fig. 73,1-3) for the following lamps:

- Entrance lighting
- Awning light
- Living area lighting
- Awning lighting (optional equipment)

### 7.6.2 Interior



▷ The lamps shown in this section are examples. Not all lamps used in the vehicle are shown. The examples are intended to clarify the possible positions for the light switches. The type and appearance of the light switches can deviate from those shown here.



Fig. 75 Spotlight, switch mounted directly on the lamp

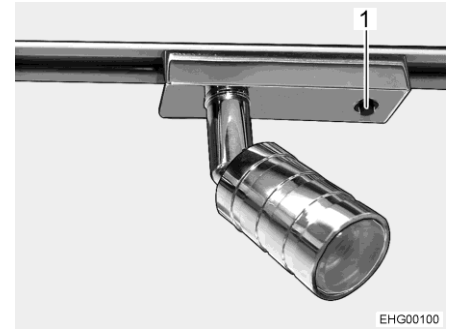

Fig. 76 Spotlight (alternative), light switch directly on the lamp

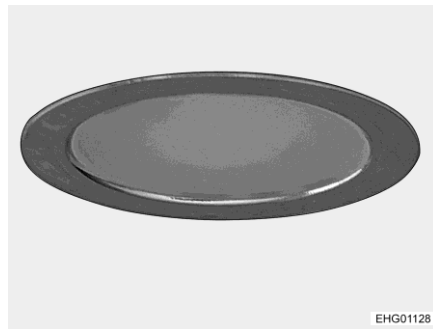

Fig. 77 Ceiling lamp

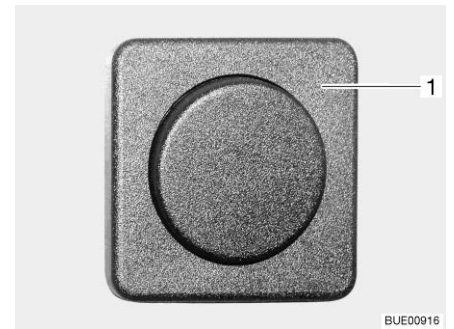

Fig. 78 Light switch

The light switches in the interior are located directly on the corresponding lamp (Fig. 75,1, Fig. 76,1) or close to the lamp (Fig. 78,1).

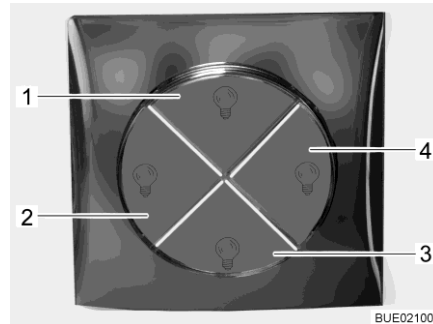

Fig. 79 Recessed light, light switch in the lamp

To switch the recessed light on and off, press the interior of the recessed light (Fig. 79,1).

### 7.6.3 Light control (optional equipment)

Depending on the model, the vehicle is equipped with a light control. At the switches in the living and sleeping area, you can switch lighting scenarios for these areas via four buttons. With the light control, you can switch combinations of various illuminants.



- 1 Main light, living area
- 2 Main light, sleeping area
- 3 Ambiente lighting, living area
- 4 Ambiente lighting, sleeping area

Fig. 80 Switch for light control

Via the buttons on the switches, you can the switch the following lighting scenarios for the living and sleeping area, respectively:

- Main light: ceiling lighting and spotlights
- Ambiente lighting: indirect lighting by various LED strips

### 7.6.4 Wardrobe light (partially optional equipment)



- ▷ The wardrobe light can be removed from its holder (Fig. 81,1) and used as a torch.
- ▷ When the wardrobe door is closed, the wardrobe light switches off automatically.
- ▷ A brightness sensor ensures that the wardrobe light comes on only when it is dark. This prevents the wardrobe light from being accidentally switched on during daylight hours, which would waste the batteries.

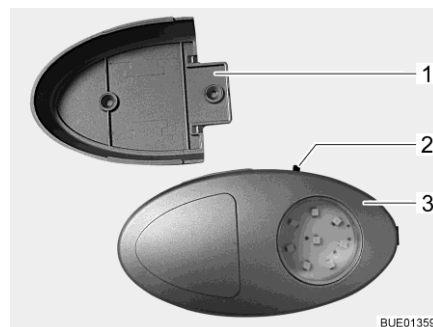

Fig. 81 Wardrobe light/torch

The On/Off switch (Fig. 81,2) is located directly on the wardrobe light (Fig. 81,3).

### 7.6.5 Tube lamp in the rear garage

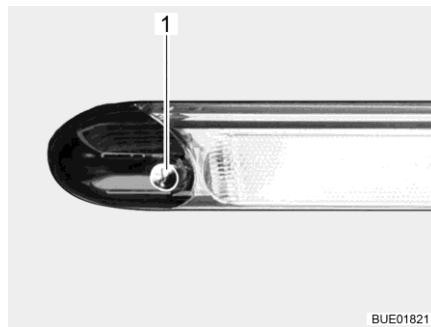

Fig. 82 Tube lamp in the rear garage

Move your hand over the sensor (Fig. 82,1) on the lamp to switch it on and off.

### 7.7 Spotlight



- ▶ Bulbs and light fittings can be extremely hot.
- ▶ Allow the light bulbs and lamp holders to cool down before touching them.
- ▶ If the light is switched on or still hot, there must always be a safety distance of at least 30 cm between stores or curtains and flammable objects. Fire hazard!

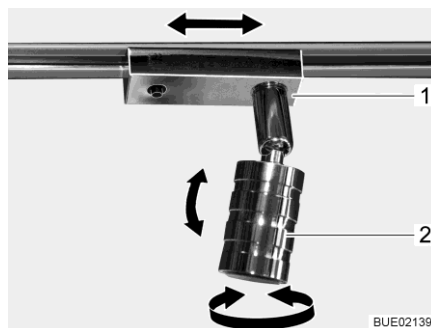

Fig. 83 Spotlight

- Rotating:**
- Grasp the housing (Fig. 83,2) and turn it.
- The housing can be turned in different directions:
- To the left and to the right
  - Up and down
- Shifting:**
- Grip socket (Fig. 83,1) and turn by approx. 45°.
  - Push spotlight along the rail system to desired position.
  - Turn socket back.
- Removing:**
- Grip socket (Fig. 83,1) and turn by 90°.
  - Remove spotlight from rail.

The spotlight can be installed in any position into the rails.

### 7.7.1 Mobile lamp (optional equipment)



- Fasten all mobile lamps at the active docking stations during the journey.

The mobile lamp can be used as an additional lamp, as a table lamp, or as a torch. The mobile lamp is equipped with a rechargeable battery, which is charged in an active docking station.

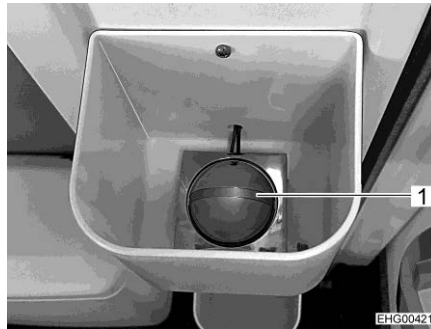

Fig. 84 Active docking station on the conversion door



Fig. 85 Active docking station on shelf above the driver's cabin

Active docking stations can be located in different places in the vehicle, e.g. in the tray of the conversion door (Fig. 84,1), on the shelf above the driver's cabin (Fig. 85,1) or in the wardrobe.



Fig. 86 Mobile lamp (pushed together)



Fig. 87 Mobile lamp (pulled out)

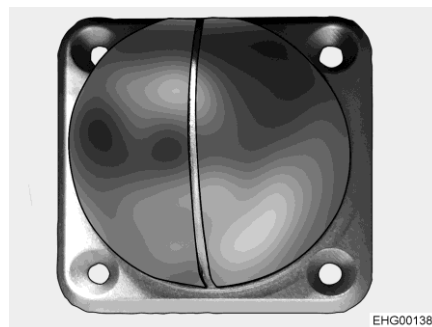



Fig. 88 Docking station (active and passive)

- Use as an additional lamp** The mobile lamp is pushed together (Fig. 86) and is plugged onto a passive docking station (Fig. 88).
- Use as table lamp** The mobile lamp is pulled out (Fig. 87) and placed on the table or any other place.
- Use as torch** The mobile lamp is pulled out (Fig. 87) and used as a torch.
- Switching on/off:** ■ Press the On/Off switch (Fig. 86,1).
- Dimming:** ■ Press and hold On/Off switch (Fig. 86,1).
-  ▷ The lighting intensity adjusted most recently is saved.
- Charging:** ■ Push lamp together (Fig. 86) and plug onto active docking station (e.g. Fig. 84,1 or Fig. 85,1).
- The LED (Fig. 86,2) next to the On/Off switch shows the charging condition.
- A red LED means that the rechargeable battery is being charged.
- A green LED means that the rechargeable battery has been charged.
-  ▷ When plugging onto the active docking station, the LED lights up red for 30 seconds.

## 7.8 Holder for flat screen



- ▶ Before commencing the journey, place and secure the flat screen and screen support in the initial position. If the screen holder is installed in a TV cabinet: Close TV cabinet.

### 7.8.1 Holder with two-piece jointed arm

The flat screen is fastened to a two-piece jointed arm and can be swivelled into any position.

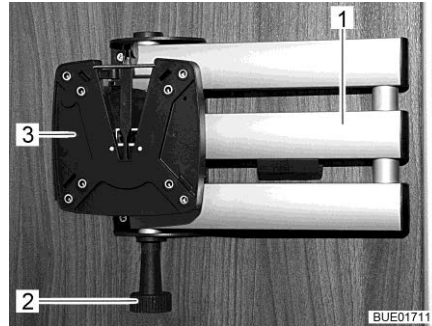

Fig. 89 Holder (two-piece jointed arm)

- Positioning:**
- Pull the release knob (Fig. 89,2). The jointed arm (Fig. 89,1) is unlocked.
  - Swivel the flat screen into the desired position.
  - Take hold of the flat screen at the top and bottom edge with both hands and set the desired angle of inclination.
- Storing away:**
- Turn the flat screen back into the original position until you hear the holder (Fig. 89,3) engage in the lock.

### 7.8.2 Wall holder

The flat screen is fastened to a wall holder.

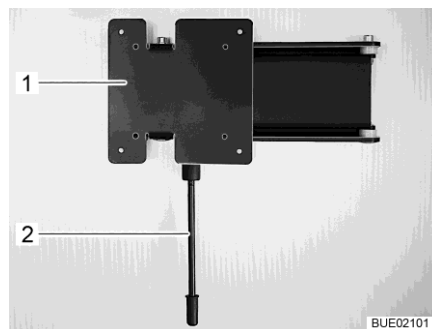

Fig. 90 Wall holder

- Positioning:**
- Pull down the release lever (Fig. 90,1) and turn the holder (Fig. 90,2) with the flat screen to the desired position.
- Storing away:**
- Pull down the release lever and push back the flat screen until the holder engages.



### 7.8.3 Holder with release lever

The holder for the flat screen is attached to the wall.

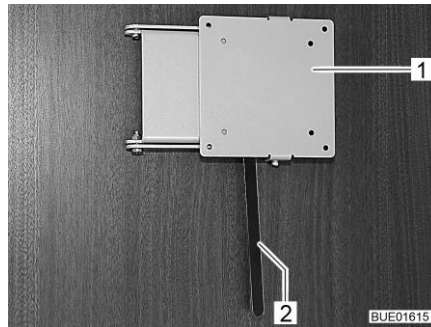

Fig. 91 Holder with release lever

- Positioning:**
- Push the release lever (Fig. 91,2) to the side and turn the holder (Fig. 91,1) with the flat screen to the desired position.
  - Press the flat screen slightly upwards and swivel it to the desired position. Three different inclination angles may be used.
- Storing away:**
- Turn flat screen back until the holder (Fig. 91,1) engages in the lock.

### 7.8.4 Holder with pull-out

The flat screen is fixed to a holder which can be pulled out and swivelled to the desired position.

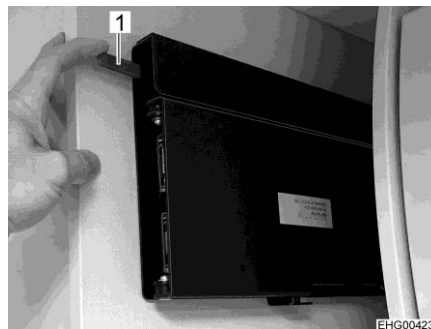

Fig. 92 Unlocking pull-out

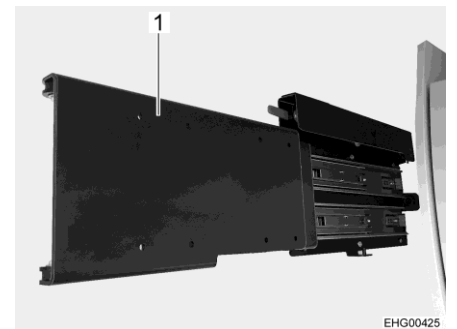

Fig. 93 Pull-out (extended)

- Positioning:**
- Press red lever (Fig. 92,1) downward and pull pull-out (Fig. 93, 1) out. The flat screen faces the living area.

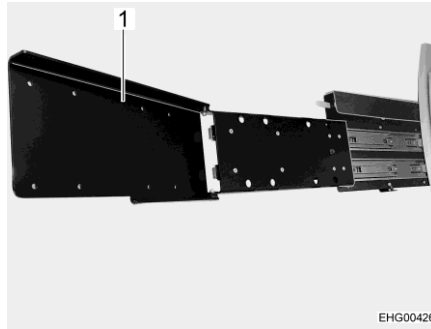

Fig. 94 Pull-out (extended and folded)

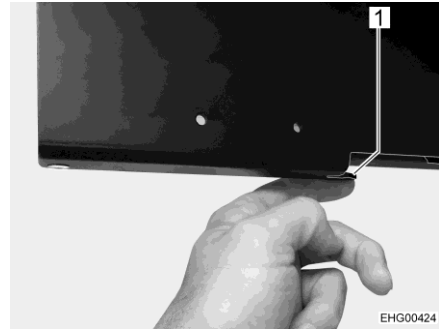

Fig. 95 Unlocking swivel mechanism

- To turn the flat screen to the rear area: fold pull-out (Fig. 94,1).
- To swivel the flat screen to the desired position: press black lever (Fig. 95,1) at the bottom of the pull-out plate and swivel flat screen.

#### Storing away:

- Swing the flat screen back into its original position.
- Push in the pull-out until the holder engages audibly.

## 7.9 Ventilation



- ▶ The oxygen in the vehicle interior is used up by breathing and the use of gas operated appliances. That is why the used air must be replaced permanently. For this purpose, forced ventilation options (e.g. skylights with forced ventilation, mushroom-shaped vents or floor vents) are fitted to the vehicle. Never cover or block forced ventilations from the inside or outside with objects such as e.g. a winter mat. Keep forced ventilations clear of snow and leaves. There is a danger of suffocation due to increased CO<sub>2</sub> levels.



- ▷ In the case of the vehicles with rear pull-down bed and skylight, condensation may form in the area of the roof curvature when the rear pull-down bed is located in the top position.  
When the vehicle is parked, lower the rear pull-down bed slightly to improve the air circulation.



- ▷ Although sufficient ventilation is provided, in certain weather conditions, condensation can form on metal objects (e.g. screwed connections in the floor).
- ▷ Additional cold spots can occur at thermal "bridges" (e.g. mushroom-shaped vents, skylight edges, sockets, filler necks, flaps, etc.).

#### Condensation

Ensure that there is a continuous exchange of air by providing frequent and efficient ventilation. This is the only method for ensuring that condensation and resulting mould is not formed during cool weather. During the colder season, a pleasant living climate is created if heating output, air distribution and ventilation are synchronised. To avoid draft close the air outlet nozzles on the dashboard and set the air distribution of the base vehicle to air circulation.

If the vehicle is laid up for a longer period, occasionally ventilate it well, especially in summer as heat accumulation can occur. Do not only air the interior, but also the storage spaces which are accessible from the outside. Air the parking place as well if the vehicle is parked in a closed space (e.g. garage). The occurrence of condensation could lead to the formation of mould.

## 7.10 Windows



- ▷ The windows are fitted with a blind or Roman shade and with an insect screen or folding insect screen. After the latch has been released, the blind and insect screen automatically spring back to the initial position by tensile force. In order not to damage the tension mechanics, hold onto the blind or insect screen and allow it to slowly return to the initial position. The Roman shade and folding insect screen are made of thin woven fabric. In order not to damage the Roman shade or the insect screen, grasp the respective handle and carefully return it to the initial position.
- ▷ Do not keep blinds closed over a longer period of time as that can cause increased material wear.
- ▷ If the blind or the Roman shade is completely closed, exposure to direct sunlight can cause heat to accumulate between the blind/the Roman shade and the window. The window could be damaged.

Therefore, if the shade is installed in the bottom blind box, close the shade only 2/3 when sunlight is intense. This allows the heat to escape between the window and the shade.

If the shade is installed in the top blind box, close the shade fully and open it regularly.

Also move the window into the "continuous ventilation" position.

- ▷ Before commencing the journey, close the windows.
- ▷ Depending on the weather, close the windows far enough to prevent moisture from entering.
- ▷ To open and close the window, open or close all catch levers which are fitted to the window.



- ▷ When leaving the vehicle, always close the windows.
- ▷ In extreme weather conditions or if the temperature fluctuates strongly, a light condensation film can form on the double-glazed acrylic glass. The glass is designed in such a way that condensation can evaporate when the external temperature increases. There is no danger of the double-glazed acrylic glass being damaged by condensation.

### 7.10.1 Hinged window



- ▷ If windows with automatic hinges are fitted, open the window fully in order to release the lock. If the locking device is not released and the window is closed nevertheless, there is the danger of the window breaking due to the massive counter-pressure.
- ▷ When opening the hinged windows, ensure that there are no torsional forces. Open and close the hinged windows evenly.
- ▷ If the catch lever is equipped with a safety knob, press the safety knob when operating the catch lever.

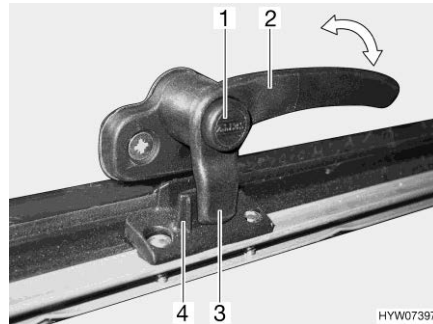

Fig. 96 Catch lever with safety knob in "closed" position

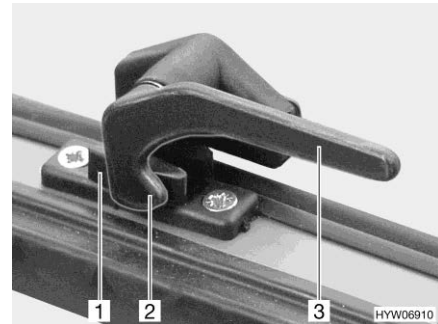

Fig. 97 Catch lever in "closed" position

- Opening:**
- Press and hold the safety knob (Fig. 96,1), if present.
  - Turn the catch lever (Fig. 96,2 or Fig. 97,3) a quarter turn towards the centre of the window.

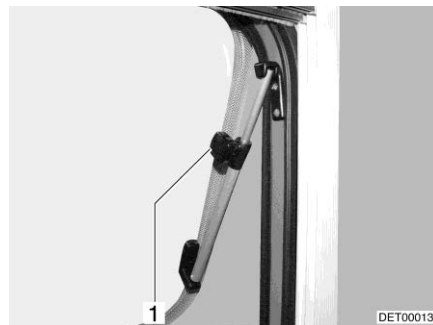

Fig. 98 Hinged window with rotary hinge



Fig. 99 Hinged window with automatic hinge

- Hinged window with rotary hinge: Open the hinged window until the required position has been reached and use knurled knob (Fig. 98,1) to secure in position.

Hinged window with automatic hinge: Open the hinged window to the desired latched position. The automatic hinge (Fig. 99,1) locks in place automatically.

The hinged window remains locked in the required position.

- Closing:**
- Hinged window with rotary hinge: Turn knurled knob (Fig. 98,1) until the latch is released.  
Hinged window with automatic hinge: Open the hinged window as wide as is necessary to release the lock.
  - Close the hinged window.
  - Press and hold the safety knob (Fig. 96,1), if present.
  - Turn the catch lever (Fig. 96,2 or Fig. 97,3) a quarter turn towards the window frame.  
The locking catch (Fig. 96,3 or Fig. 97,2) on the catch lever is entirely on the inner side of the window catch (Fig. 96,4 or Fig. 97,1).

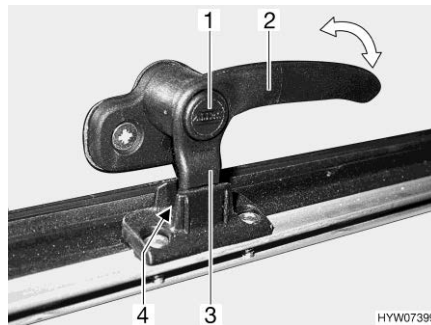

Fig. 100 Catch lever with safety knob in "continuous ventilation" position

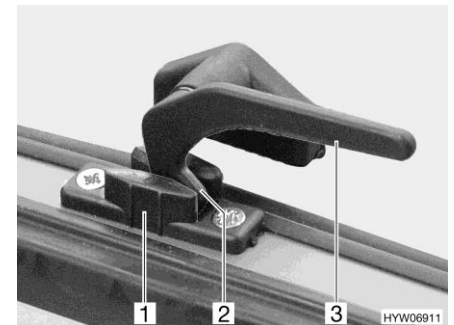

Fig. 101 Catch lever in "continuous ventilation" position

### Continuous ventilation

With the catch lever, the hinged window can be placed in two positions:

- "Continuous ventilation" (Fig. 100 and Fig. 101)
- "Firmly closed" (Fig. 96 and Fig. 97)

To place the hinged window into the "continuous ventilation" position:

- Press and hold the safety knob (Fig. 100,1), if present.
- Turn the catch lever (Fig. 100,2 or Fig. 101,3) a quarter turn towards the centre of the window.
- Slightly open the hinged window outwards.
- Return the catch lever to its initial position. Move the locking catch (Fig. 100,3 or Fig. 101,2) on the catch lever into the recess of the window catch (Fig. 100,4 or Fig. 101,1).
- Press and hold the safety knob (Fig. 100,1), if present.
- Make certain that the safety knob is not pushed in but rather that it secures the catch lever.

During the journey, the hinged window may not be in "continuous ventilation" position.

If it rains, the "continuous ventilation" hinged window position could lead to splashing water penetrating the living area. Therefore, close the hinged windows completely.

### 7.10.2 Sliding window with pressure lock



Fig. 102 Sliding window, locked

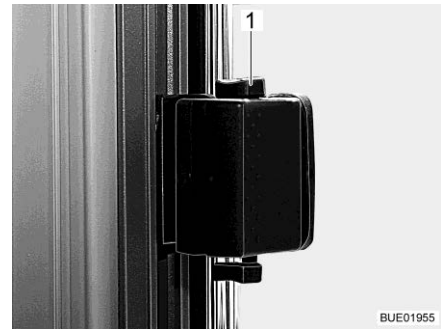

Fig. 103 Sliding window, unlocked

- Opening:**
- Push the latch (Fig. 102,1) downwards.
  - Open the window to the desired position.
- Closing:**
- Close the window as far as it can go.
  - Push the latch (Fig. 103,1) upwards.

### 7.10.3 Blind and insect screen



- ▷ Open blinds before commencing the journey. When the blinds are closed, vibrations can damage the spring shaft.



- ▷ Depending on the window size, the blinds are fitted with one or two handles.

The windows are fitted with a blind and an insect screen. The blind and insect screen are adjusted separately.

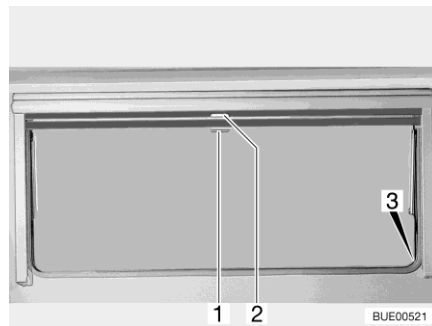

Fig. 104 Hinged window

**Blind** The blind is located in the upper blind box.

- Closing:**
- Pull blind at the handle (Fig. 104,2) downwards. If the blind is to be completely closed, it is suspended into the locking devices (Fig. 104,3) situated on both sides of the window frame.

- Opening:**
- If the blind is completely closed: Press handle (Fig. 104,2) downwards and, at the same time, tilt it slightly inward. The blind can be taken out of the locking devices situated on both sides of the window frame.
  - If the blind is in an intermediate position: Pull the handle (Fig. 104,2) slightly downwards until the locking device releases.
  - Use handle to return blind slowly to its initial position.

**Insect screen** The insect screen is located in the upper blind box.

- Closing:**
- Pull insect screen at the handle (Fig. 104,1) down and hang it into the locking devices (Fig. 104,3) situated on both sides of the window frame.
- Opening:**
- Press handle (Fig. 104,1) downwards and, at the same time, tilt it slightly inward. The insect screen can be taken out of the locking devices situated on both sides of the window frame.
  - Use handle to return the insect screen slowly to its initial position.

#### 7.10.4 Roman shade and insect screen

The windows are fitted with a Roman shade and an insect screen. The insect screen can only be moved together with the Roman shade.

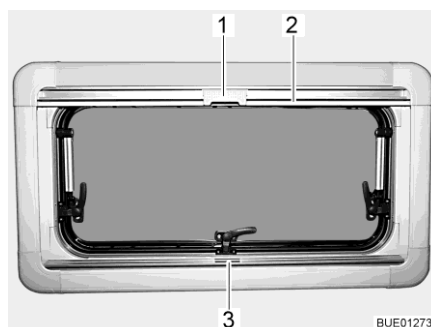

Fig. 105 Hinged window

**Roman shade** The Roman shade is located in the bottom blind box.

- Closing:**
- Grip the Roman shade in the centre of the holding bar (Fig. 105,3), pull it from the bottom to the top and then release it at the desired height. The Roman shade will stay at this height.
- Opening:**
- Grip the Roman shade in the centre of the holding bar and push it down.

**Insect screen** The insect screen is located in the upper blind box.

- Closing:**
- Pull the insect screen down using the holding bar (Fig. 105,2), until it touches the holding bar of the Roman shade (Fig. 105,3).
  - Clip the catch (Fig. 105,1) on the insect screen into the handle of the Roman shade.
- Opening:**
- Push the catch (Fig. 105,1) on the insect screen inwards.
  - Move the insect screen back slowly on the holding bar (Fig. 105,2).

### 7.10.5 Roman shades for windscreen, driver's window and front passenger's window

Depending on the model, the driver's cabin is shaded either with pleated shades or with Remis Roman shades (special equipment).

**Pleated shades** The pleated shades are standard equipment on the vehicle.

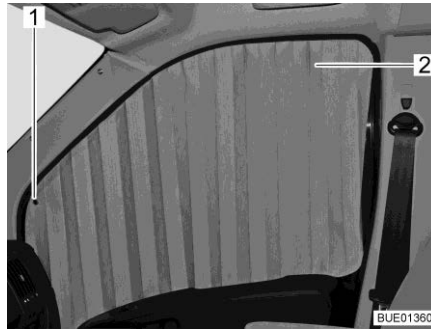

Fig. 106 Pleated shades on passenger window



Fig. 107 Fixing of pleated shades

The pleated shades (Fig. 106,2) are fixed with snap fasteners (Fig. 106,1 and Fig. 107,1).

#### Remis Roman shades (special equipment)

The Roman shades are fixed with magnetic strips and are permanently fitted to the vehicle inside the frame.

Proceed as described below to open or close permanently installed Roman shades.

#### Roman shade for the windscreen



Fig. 108 Roman shade (windscreen)

- Shading:**
- Press the release handles (Fig. 108,1) and hold them down.
  - Use the handle (Fig. 108,2) to pull the Roman shade for the windscreen towards the centre of the window.
  - Close the second Roman shade for the windscreen in the same way. A magnetic catch holds both parts of the Roman shade together in the centre.



**Opening the Roman shade:**

- Press the release handles (Fig. 108,1) and hold them down.
- Use the handle (Fig. 108,2) to pull the two halves of the Roman shade for the windscreen outwards as far as they will go. As you do so, lift the handle up as high as the locking recess.
- Let go of the release handles (Fig. 108,1) and let them engage.

**Roman shades for driver's window and front passenger's window**

Fig. 109 Roman shade (driver's / front passenger's window)

**Shading:**

- Press the release handles (Fig. 109,1) and hold them down.
- Using the handle (Fig. 109,2), draw the Roman shades for the driver's and passenger's window to the other side of the window and secure them to the magnetic strips.

**Opening the Roman shade:**

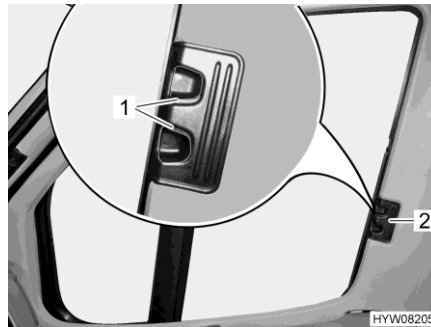
- Press the release handles (Fig. 109,1) and hold them down.
- Use handle (Fig. 109,2) to push in the Roman shades for the driver's and passenger's window as far as possible.
- Let go of the release handles (Fig. 109,1) and let them engage.

**7.10.6 Vario blind**

Fig. 110 Vario blind, rear area

**Darkening/shading:**

- Pull the strand of the pull chain (Fig. 110,1) that closes the Vario blind until the Vario blind is in the desired position.

**Lifting darkening:**

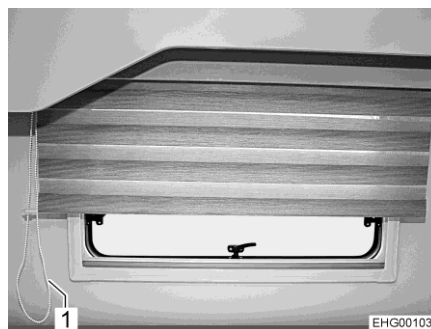
- Pull the strand of the pull chain (Fig. 110,1) that opens the Vario blind until the Vario blind is in the desired position.

## 7.11 Skylights

Depending on the model, skylights with or without forced ventilation are fitted to the vehicle. If a skylight is fitted without forced ventilation, the forced ventilation is performed using mushroom-shaped vents.



- ▶ The apertures for forced ventilation must always be kept open. Never cover or block forced ventilations with objects such as e.g. a winter mat. Keep forced ventilations clear of snow and leaves.



- ▷ The skylights are fitted with a blind or Roman shade and with an insect screen or folding insect screen. After the latch has been released, the blind and insect screen automatically spring back to the initial position by tensile force. In order not to damage the tension mechanics, hold onto the blind or insect screen and allow it to slowly return to the initial position. The Roman shade and folding insect screen are made of thin woven fabric. In order not to damage the Roman shade or the insect screen, grasp the respective handle and carefully return it to the initial position.
- ▷ Do not keep blinds closed over a longer period of time as that can cause increased material wear.
- ▷ If the blind or the Roman shade is completely closed, exposure to direct sunlight can cause heat to accumulate between the blind/the Roman shade and the skylight. The skylight could be damaged. For that reason, close the blind/Roman shade only 2/3 of the way in direct sunlight. Open the skylight slightly or move it to ventilation position.
- ▷ Depending on the weather, close the skylights far enough to prevent moisture from entering.
- ▷ Do not climb on the skylights.
- ▷ Before commencing the journey, close the skylights.
- ▷ Before commencing the journey, check that the skylights are closed and locked.



- ▷ When leaving the vehicle, always close the skylights.

### 7.11.1 Skylight with snap latch



Fig. 111 Skylight with snap latch

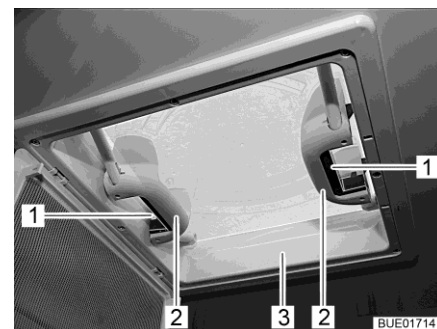

Fig. 112 Handles with snap latches

The skylight can be pushed upwards either from one side or from both sides.

- Opening:**
- Use handle (Fig. 111,1) to swing down the insect screen (Fig. 111,2).
  - Push the snap latch (Fig. 112,1) towards the inside of the skylight (Fig. 112,3). At the same time use the handle (Fig. 112,2) to press the skylight upwards.
  - Swing insect screen upwards until it latches in place.
- Closing:**
- Use handle (Fig. 111,1) to swing down the insect screen (Fig. 111,2).
  - Using both handles (Fig. 112,2), pull down the skylight (Fig. 112,3) with force until the two snap latches (Fig. 112,1) lock into place.
  - Swing insect screen upwards until it latches in place.

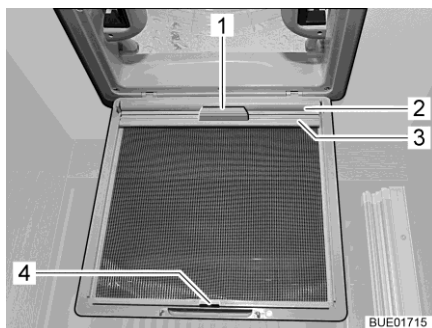

Fig. 113 Blind (skylight)

**Blind** Depending on the equipment, there will be a blind installed.

- Closing:**
- Use handle (Fig. 111,1) to swing down the insect screen (Fig. 111,2).
  - Using the handle (Fig. 113,1), pull out the blind (Fig. 113,2) and hook the retainer (Fig. 113,3) into the hook (Fig. 113,4) on the insect screen.
  - Swing insect screen upwards until it latches in place.
- Opening:**
- Use handle (Fig. 111,1) to swing down the insect screen (Fig. 111,2).
  - Release the retainer (Fig. 113,3) from the hook (Fig. 113,4) and, using the handle (Fig. 113,1), slowly return the blind (Fig. 113,2).
  - Swing insect screen upwards until it latches in place.

### 7.11.2 Heki skylight (partially optional equipment)

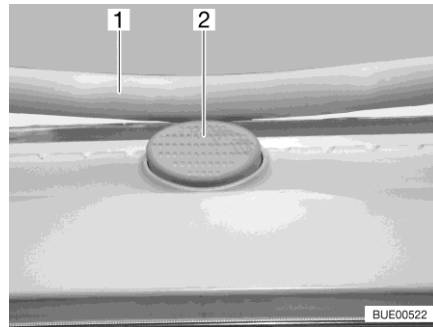

Fig. 114 Safety knob (Heki skylight)

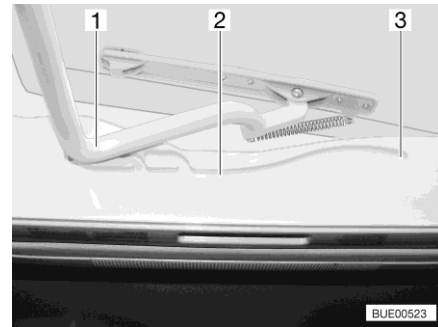

Fig. 115 Guide (Heki skylight)

The Heki skylight is opened on one side only.

- Opening:**
- Press the safety knob (Fig. 114,2) and pull the bar (Fig. 114,1) down with both hands.
  - Pull the bar (Fig. 115,1) in the guides (Fig. 115,2) to the rearmost position (Fig. 115,3).
- Closing:**
- Use both hands to push the bar (Fig. 115,1) slightly upwards.
  - Push the bar back in the guides.
  - Push the bar upwards with both hands until it is above the safety knob (Fig. 114,2).

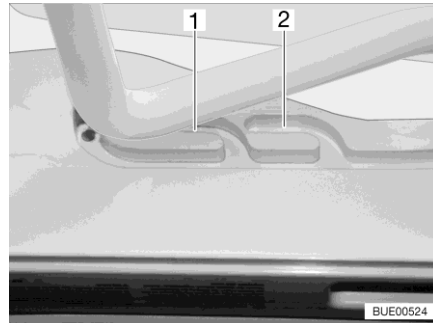

Fig. 116 Guide (ventilation position)

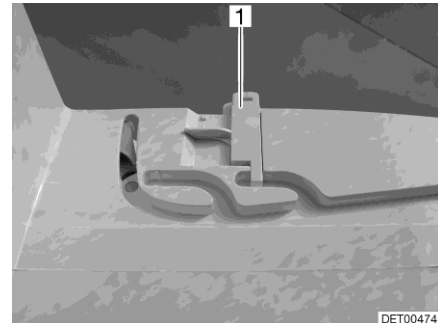

Fig. 117 Lock (ventilation position)

#### Ventilation position

The Heki skylight can be put in two ventilation positions: Bad weather position (Fig. 116,1) and central position (Fig. 116,2). Depending on the model, the skylight can be locked in the central position with both left and right latches (Fig. 117,1) on the skylight frame.

- Press the safety knob (Fig. 114,2) and pull the bar (Fig. 114,1) down with both hands.
- Pull the bar in the guides (Fig. 115,2) to the desired position.
- Push the bar slightly upwards and into the selected guide (Fig. 116,1 or 2) and lock if necessary.

- Roman shade** To close and open the Roman shade:
- Closing:** ■ Pull out Roman shade at the handle and release in the required position. The Roman shade will stay in that position.
- Opening:** ■ Slowly push the Roman shade at the handle to its initial position.

- Insect screen** To close and open the insect screen:
- Closing:** ■ Pull the insect screen by the handle to the opposite handle of the Roman shade.
- Opening:** ■ Press the rear part of the handle of the insect screen. The latch is released.
- Use handle to return the insect screen slowly to its initial position.

### 7.11.3 Sunroof skylight (partially optional equipment)



- ▷ When opening the skylight, ensure that there are no torsional forces. Open and close the skylight evenly.
- ▷ If the catch lever is equipped with a safety knob, press the safety knob when operating the catch lever.

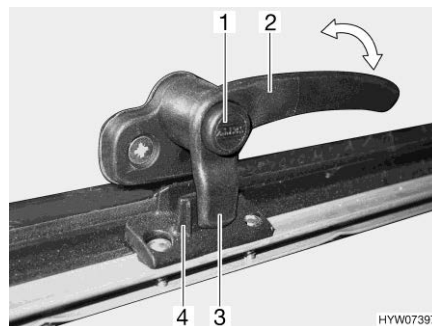

Fig. 118 Catch lever with safety knob in "closed" position

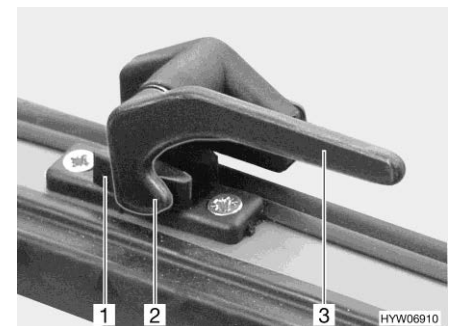

Fig. 119 Catch lever in "closed" position

- Opening:** ■ Press and hold the safety knob (Fig. 118,1), if present.
- Turn all catch levers (Fig. 118,2 or Fig. 119,3) a quarter turn towards the centre of the skylight.
- Press and hold the safety knob, if present.

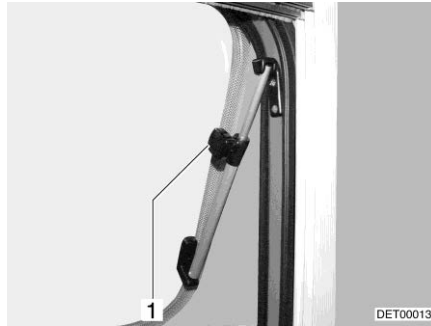

Fig. 120 Skylight with rotary hinges, open

- Open the skylight until the required position has been reached and use knurled knob (Fig. 120,1) to secure in position.

The skylight remains locked in the desired position.

#### Closing:

- Turn knurled knob (Fig. 120,1) until the latch is released.
- Close the skylight.
- Press and hold the safety knob (Fig. 118,1), if present.
- Turn all catch levers (Fig. 118,2 or Fig. 119,3) a quarter turn towards the frame. The locking catch (Fig. 118, 3 or Fig. 119,2) is located on the inside of the skylight lock (Fig. 118,4 or Fig. 119,1).
- Press and hold the safety knob, if present.

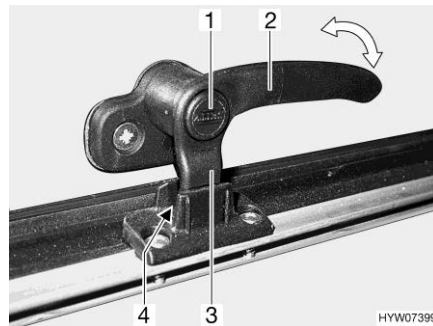

Fig. 121 Catch lever with safety knob in "continuous ventilation" position

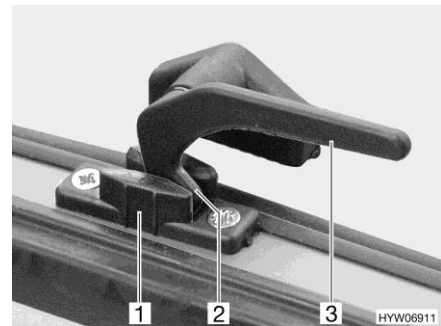

Fig. 122 Catch lever in "continuous ventilation" position

#### Continuous ventilation

With the catch levers, the skylight can be placed in 2 different positions:

- "Continuous ventilation" (Fig. 121 and Fig. 122)
- "Firmly closed" (Fig. 118 and Fig. 119)

To place the skylight into the "continuous ventilation" position:

- Press and hold the safety knob (Fig. 121,1), if present.
- Turn all catch levers (Fig. 121,2 or Fig. 122,3) a quarter turn towards the centre of the skylight.
- Slightly push the skylight outwards.

- Return all catch levers to their initial position. The locking catch (Fig. 121,3 or Fig. 122,2) has to be moved into the recess of the skylight lock (Fig. 121,4 or Fig. 122,1).
- Press and hold the safety knob, if present.

During the journey, the skylight may not be in the "continuous ventilation" position.

If it rains, the "continuous ventilation" skylight position could lead to splashing water penetrating the living area. Therefore, close the skylight completely.



- ▷ If the Roman shade is completely closed, heat can accumulate between the Roman shade and the glass windows when exposed to direct sunlight. The skylight could be damaged. For that reason, close the Roman shade only 2/3 of the way in direct sunlight. Open the skylight slightly or move it to ventilation position.



Fig. 123 Sunroof skylight

**Roman shade** The Roman shade is fitted in the frame, at the bottom.

- Closing:**
- Hold the Roman shade in the centre of the bottom rod and carefully draw it upwards.
  - Release the Roman shade at the desired position. The Roman shade will stay in that position.
- Opening:**
- Carefully return the bottom rod of the Roman shade downwards to the limit stop on the frame.

**Insect screen** The insect screen is fitted in the frame, at the top.

- Closing:**
- Hold the insect screen in the centre of the bottom rod and carefully pull it down.
  - Continuous adjustment of the insect screen may be made by moving the bottom rod.
- Opening:**
- Carefully return the bottom rod of the insect screen upwards to the limit stop on the frame.

## 7.12 Tables

Depending on the model and equipment, various types of tables may be installed. The tables' features differ in the following ways:

	Table leg	Table top	Conversion to bed foundation
<b>Fixed table</b>	Screwed to the floor	Shiftable, rotatable, divisible, partially extendible	Not possible
<b>Suspension table</b>	<ul style="list-style-type: none"> <li>• Changeable</li> <li>• Foldable</li> <li>• Divisible</li> </ul>	Extendible	Hang the table top from the top into the bottom mounting rail <ul style="list-style-type: none"> <li>• Fold in the table leg</li> <li>• Change the table leg</li> <li>• Divide the table leg</li> </ul>
<b>Lift-off table</b>	Lifting mechanism	Shiftable, rotatable, divisible	Lower the table



▷ Depending on the model, the tables can be adjusted in one or more of the aforementioned ways.

The tables' main operation is described below. The type and position of the operating controls may vary slightly.

### 7.12.1 Fixed table

**Table leg** The table leg is screwed into the floor.

The fixed table cannot be used as a bed foundation.

**Adjusting the table top** Depending on the model, the table top can be rotated, moved or extended.





Fig. 124 Unlocking of the table top



Fig. 125 Swing-out table extension

- Rotating the table top:**
- Rotate table top to the desired position. In order to do this, you need a little effort, because the table top rotates against the friction resistance on the pillar table leg.
- Shifting the table top:**
- Fold lever (Fig. 124,1) downward.
  - Push the table top to the desired position.
  - Fold the lever back upwards.
- Expanding the table:**
- Pull the knob (Fig. 125,3) of the lock down and swing out the table extension (Fig. 125,2).
- Reducing the table size:**
- Swing the table extension (Fig. 125,2) under the table top (Fig. 125,1) until the lock latches in place audibly.

### 7.12.2 Suspension table

#### Table leg

The table leg can be set up at two different heights:

- Normal table height
- Decreased table height (when converting to a bed foundation) (partially optional equipment)

To lower the table, there are the following possibilities (depending on model):

- Replacing the long table leg with a short one
- Folding in one part of the table leg
- Removing one part of the table leg

**Table top** Depending on the model, the table top can be extended.



Fig. 126 Swing-out table extension

**Expanding the table:** ■ Pull the knob (Fig. 126,3) of the lock down and swing out the table extension (Fig. 126,2).

**Reducing the table size:** ■ Swing the table extension (Fig. 126,2) under the table top (Fig. 126,1) until the lock latches in place audibly.

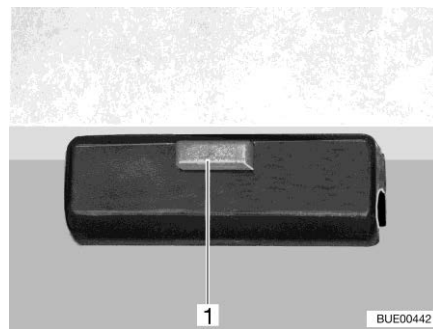

Fig. 127 Lock

**Conversion to bed foundation:**

- Lift the front of the table top by approx. 45°.
- Depending on the model, shorten the table leg to the conversion level.
- Release the lock (Fig. 127,1) on the table top.
- Take the table top out of the upper retainer.
- Hook the table top at a 45° angle to the supports into the lower retainer and place on the floor with the shortened table leg.
- Lock the table top.

### 7.12.3 Lift-off table

**Table leg** The table leg is screwed into the floor. The table can be lowered via a lifting mechanism to become a bed foundation.

**Adjusting the table top** Depending on the model, the table top can be moved both lengthwise and crosswise.



Fig. 128 Adjustment of lift-off table

**Moving in a lengthways direction:**

- Fold lever (Fig. 128,1) downward.
- Push the table top to the desired position.
- Fold the lever back upwards.

**Moving in a crossways direction:**

- Fold lever (Fig. 128,1) downward.
- Push the table top to the desired position.
- Fold the lever back upwards.



▷ Before lowering the table top, remove the cushions from the benches or shift the table top (depending on the installation situation).

**Rotating the table top:**

- Rotate table top to the desired position. In order to do this, you need a little effort, because the table top rotates against the friction resistance on the pillar table leg.

**Lowering table top to bed foundation:**

- Lift the table top slightly upwards and then push it all the way down.

**Moving the table top upwards:**

- Press table top down slightly. The table top moves upwards.

### 7.12.4 Lift-off table, divisible

**Table leg** The table leg is screwed into the floor. The table can be converted into the bed foundation by means of a lifting mechanism.

**Table top** The table top can be shifted both lengthwise and crosswise. The table top can be reduced to half the size to provide more freedom of movement in the living area.



Fig. 129 Lift-off table

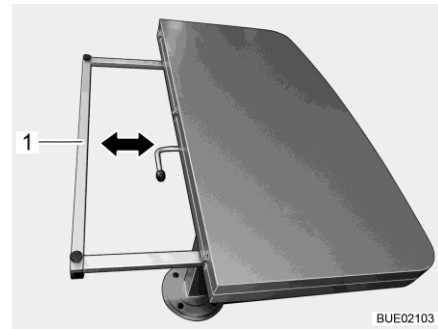

Fig. 130 Reducing the table top size

**Shifting the table top:**

- Fold the catch lever (Fig. 129,1) on the underside of the table downward.
- Push the table top to the desired position.
- Fold the lever back upwards.

**Reducing the table top size:**

- Lift table top half by its free side and set it down carefully on the other table top half.
- Hold the supporting frame (Fig. 130,1) on both sides and push it underneath the table top as far as it will go.



▷ Before increasing the table tops' size again, pull the supporting frame out as far as it will go. Only then set the table top half down on it. The hinges could otherwise be damaged.



▷ Before lowering the table top, remove the cushions from the benches or shift the table top (depending on the installation situation).

**Lowering table top to bed foundation:**

- Lift the table top slightly upwards and then push it all the way down.

**Moving the table top upwards:**

- Press table top down slightly. The table top moves upwards.

### 7.12.5 Coffee table (dependent on model)

The coffee table can be lowered. The coffee table can be stored in the seat box.

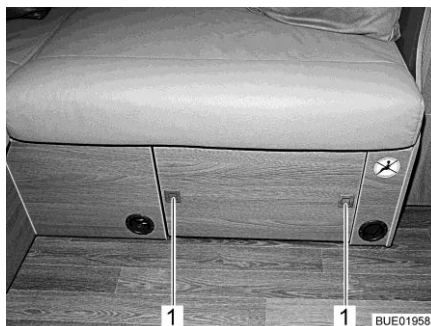

Fig. 131 Coffee table, stored

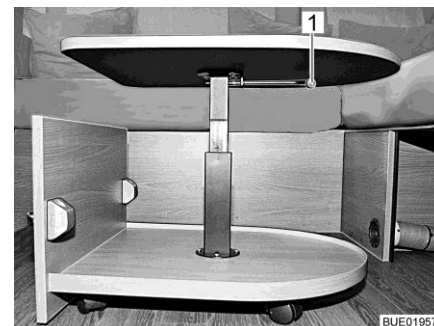

Fig. 132 Coffee table, extended

- Extending the coffee table:**
- Press the push buttons (Fig. 131,1) on the seat box panel. The push buttons jump out.
  - Pull the coffee table out.
- Adjusting the table height:**
- Turn the catch lever (Fig. 132,1) 90° downwards.
  - Push the table top to the desired position.
  - Turn the catch lever upwards again.
- Storing the coffee table:**
- Turn the catch lever 90° downwards and lower the coffee table.
  - Run the coffee table into the seat box.
  - Press the push buttons (Fig. 131,1) in until they engage.

### 7.12.6 Suspension table with fold-out leg

**Table leg** The fold-out leg can be folded at the centre for the conversion to bed. Two additional support legs can then be inserted on the table top's bottom side.

**Table top** The suspension table size can be enlarged by inserting a table top extension.

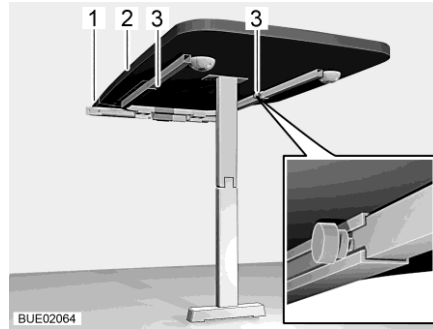

Fig. 133 Suspension table with fold-out leg

**Expanding the table:**

- Release two knurled screws (Fig. 133,3).
- Raise the table top (Fig. 133,2) slightly and pull it out as far as possible. The table extension has now been fully pulled out.
- Set the table down on the floor again.
- Insert the table top extension (Fig. 133,1) into the table extension.
- Lift the table top slightly and push back as far as possible.
- Tighten two knurled screws.

**Reducing the table size:**

- Release two knurled screws (Fig. 133,3).
- Slightly lift the front of the table top (Fig. 133,2) and pull out.
- Remove the table top extension (Fig. 133,1) and store it securely.
- Lift the table top slightly and push back as far as possible. The table extension has now been fully pushed in.
- Tighten two knurled screws.
- Set down the table.

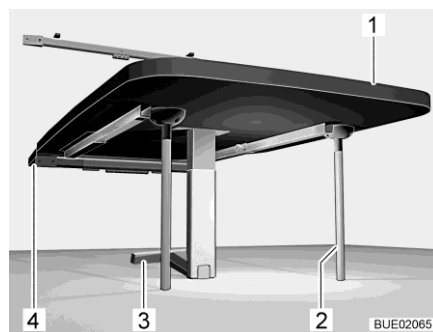

Fig. 134 Suspension table as bed foundation

**Conversion to bed foundation:**

- Increase the table size using table-top extension (see above).
- Lift the front of the table top (Fig. 134,1).
- Fold the lower part of the fold-out leg (Fig. 134,3) by 90°.
- Swing the table top approx. 45° upward and lift the table out of the upper retainer.

- Insert two additional support legs (Fig. 134,2) on the table top's bottom side.
- Insert and lock the table in the lower retainer (Fig. 134,4).

## 7.13 Beds

### 7.13.1 Fixed bed (gas-pressure springs)



- ▷ Lower the slatted frame before setting off.
- ▷ Do not put the weight of heavy objects onto the bed during the journey.

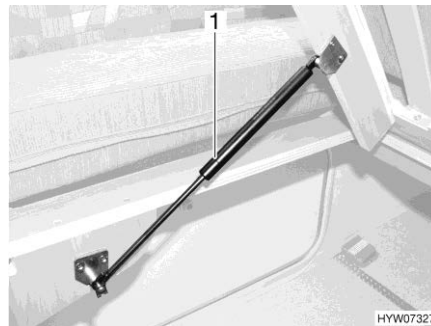

Fig. 135 Fixed bed

A storage space is underneath the bed. Lift up the slatted frame to place items in the storage space or to empty it from the inside of the vehicle.

- Opening:**
- Lift the mattress forwards.
  - Lift slatted frame. The gas-pressure springs (Fig. 135,1) hold the slatted frame open.
- Closing:**
- Press the slatted frame downwards against the resistance of the gas-pressure springs.

### 7.13.2 Fixed bed (adjustable head section)



- ▶ Do not let the slatted frame fall down when closing the bed!



- ▷ Lower the head section before setting off.
- ▷ If the head section has been raised: do not put the entire body weight on the head section (e.g. do not kneel on the head section). Do not put the weight of heavy objects onto the head section.



Fig. 136 Adjustable head section

Depending on the configuration, the head section of the slatted frame can be adjusted in several stages.

- Raising the head section:**
- Raise the head section (Fig. 136,2) of the slatted frame to the desired position. The support (Fig. 136,1) locks automatically into place.
  - The head section remains locked in the required position.

- Lowering the head section:**
- Raise the head section (Fig. 136,2) of the slatted frame until the lock is released.
  - Guide the head section downwards slowly.

### 7.13.3 Fixed bed, height-adjustable via strap system (optional equipment)



- ▶ Lower the bed to its lowest position to sleep in it.



- ▷ Before using the bed, make sure that the lever of the locking device is in the locked position (horizontal).
- ▷ If the head section has been raised: do not put the entire body weight on the head section (e.g. do not kneel on it). Do not put the weight of heavy objects onto the head section.
- ▷ Lower the head section before setting off.

The height of the fixed bed can be adjusted via a crank in the rear garage. The bed can be raised before setting off. This increases the storage space under the bed.



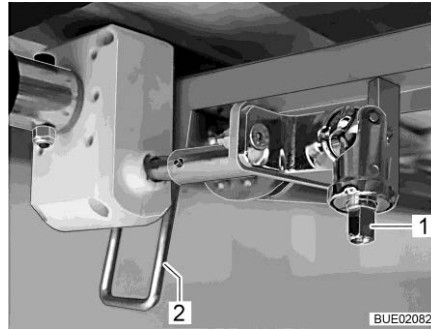

Fig. 137 Height adjustment

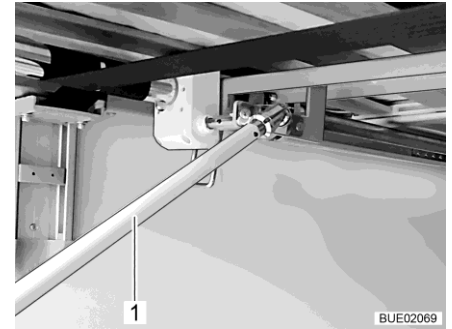

Fig. 138 Crank in the rear garage

- Attach the crank onto the journal (Fig. 137,1).
- Swivel the lever (Fig. 137,2) downwards into vertical position.
- To lift the bed: Turn the crank (Fig. 138,1) clockwise.  
To lower the bed: Turn crank (Fig. 138,1) in an anticlockwise direction.
- Swivel the lever (Fig. 137,2) upwards into horizontal position.
- Remove the crank and store it.

#### 7.13.4 Pull-down bed, electrically operated



- ▶ The maximum permitted pull-down bed load is 200 kg.
- ▶ Do not reach into the area between the bed and the side wall when lowering or raising. Danger of bruises!
- ▶ Do not lower or lift the bed when there are people using the pull-down bed.
- ▶ Only lower the bed if the lowering area is clear.
- ▶ Only lower the pull-down bed so far that it does not lie on any obstacles such as headrests, cushions or anything similar. If possible, remove such obstacles before lowering.
- ▶ Do not allow children to play with the pull-down bed.
- ▶ Store the key for the control unit such that children have no access to it.
- ▶ Only use the pull-down bed, if the safety net is set up.
- ▶ Use separate children's beds or travel cots suitable for children.
- ▶ Never allow small children to remain in the pull-down bed without supervision.
- ▶ But in particular with regard to small children less than 6 years of age, users should ensure that they cannot fall out of the pull-down bed.



- ▷ Before starting a journey, the pull-down bed must be in the top end position. Do not stow any bulky items or bedding on the pull-down bed so that the pull-down bed can move to the top end position.

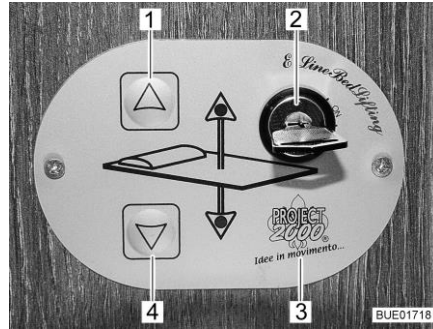

Fig. 139 Control unit

**Control unit**

The pull-down bed is raised or lowered using the buttons (Fig. 139,1 and 4) on the control unit (Fig. 139,3). The control unit is protected against unauthorized use with the key switch (Fig. 139,2).

The pull-down bed's height may be adjusted steplessly.

**Lowering the pull-down bed:**

- Removing any obstacles in the area into which the pull-down bed extends: Push the seats forwards and rotate; remove or fold cushions if necessary.
- Switch off the lamps underneath the pull-down bed.
- Turn the key in the key switch (Fig. 139,2) by 90° in a clockwise direction to position "On". The control unit (Fig. 139,3) is activated.
- Press the arrow key (Fig. 139,4) and keep it pressed until the pull-down bed has moved down into the desired position.
- Ensure that the pull-down bed is not resting on obstacles such as head-rests, cushions or similar.

**Lifting the pull-down bed:**

- Switch off the reading lamps in the pull-down bed.
- Press the arrow key (Fig. 139,1) and keep it pressed until the pull-down bed has moved down into the final upper position.
- Ensure that there are no objects stuck between the roof and the pull-down bed.

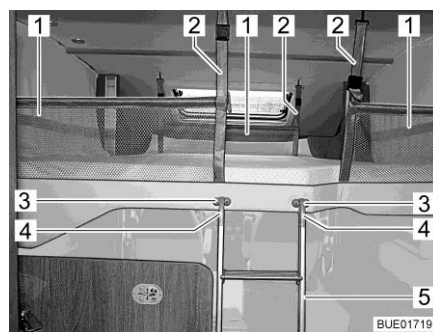

Fig. 140 Pull-down bed complete with applied safety net



Fig. 141 Pull-down bed, completely lowered (dependent on model)

**Safety net**

The three safety nets (Fig. 140,1) with their retaining belts are located underneath the mattress in the pull-down bed. Only use the safety nets if persons are already in the pull-down bed.



- ▷ If the pull-down bed is lowered below 1 m (Fig. 141), it will not be possible to set up the safety nets.

**Setting up:** ■ Attach retaining belts (Fig. 140,2) to the hooks on the ceiling.

**Access ladder** If the pull-down bed is raised over 1 m, only access the pull-down bed using the access ladder provided.

**Attaching:** ■ Hook both bows (Fig. 140,4) of the access ladder (Fig. 140,5) into the holders (Fig. 140,3).

**Storing away:** ■ Release the access ladder (Fig. 140,5) from the holders (Fig. 140,3).  
■ Store the access ladder securely.

### Emergency operation

If it is no longer possible to move the pull-down bed with the arrow keys (Fig. 139,1 and 4), first of all check the fuses (see section 9.10.1). If the fuses are okay and it is still not possible to move the pull-down bed, the pull-down bed can be operated manually.

- Remove mattress from pull-down bed and reduce the load of the storage cupboards to a minimum.

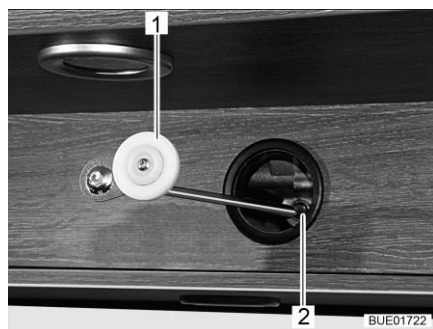

Fig. 142 Mechanical operation, drive

- Insert the crank provided (Fig. 142,1) or an Allen wrench into the accommodation on the motor (Fig. 142,2).
- Turn crank or Allen wrench manually until the pull-down bed has reached the upper parking position.

### 7.13.5 Pull-down bed at the rear, electrically operated (Lyseo TD) (optional equipment)



- ▶ Before setting off, always move the pull-down bed into the top end position.
- ▶ The maximum permitted pull-down bed load is 200 kg.
- ▶ Do not reach into the area between the bed and the side wall when lowering or raising. Danger of bruises!
- ▶ Do not lower or lift the bed when there are people using the pull-down bed.
- ▶ Only lower the bed if the lowering area is clear.
- ▶ Only lower the pull-down bed so far that it does not lie on any obstacles such as headrests, cushions or anything similar. If possible, remove such obstacles before lowering.
- ▶ Do not allow children to play with the pull-down bed.
- ▶ Store the key for the control unit such that children have no access to it.
- ▶ Use separate children's beds or travel cots suitable for children.
- ▶ Never allow small children to remain in the pull-down bed without supervision.
- ▶ But in particular with regard to small children less than 6 years of age, users should ensure that they cannot fall out of the pull-down bed.



- ▷ Before starting a journey, the pull-down bed must be in the top end position. Do not stow any bulky items or bedding on the pull-down bed so that the pull-down bed can move to the top end position.
- ▷ In the case of the vehicles with rear pull-down bed and skylight, condensation may form in the area of the roof curvature when the rear pull-down bed is located in the top position.  
When the vehicle is parked, lower the rear pull-down bed slightly to improve the air circulation.

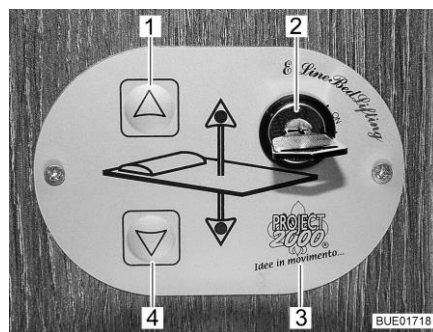

Fig. 143 Control unit

**Control unit** The pull-down bed is raised or lowered using the buttons (Fig. 143,1 and 4) on the control unit (Fig. 143,3). The control unit is protected against unauthorized use with the key switch (Fig. 143,2).



Fig. 144 Fixed corner element, rear area couch (dependent on model)

Before lowering the pull-down bed, remove the fixed corner element (Fig. 144).



Fig. 145 Storage compartment and removed back cushion



Fig. 146 Pull-down bed at the rear, lowered

#### Lowering the pull-down bed:

- Remove back cushion (Fig. 145,1) of the rear seating group.
- Remove any other obstacles in the area into which the pull-down bed extends, e.g. bring the television into driving position.
- Switch off the lamps underneath the pull-down bed.
- For T/IT 745: Fold table top in the rear. Thereby, the pull-down bed can rest on the table top's bottom side which is upholstered with felt. This prevents furniture parts from damage.
- Turn the key in the key switch (Fig. 143,2) through 90° clockwise. The control unit (Fig. 143,3) is activated.
- Press the arrow key (Fig. 143,4) and keep it pressed until the pull-down bed has moved down into the desired position.
- Make sure that the pull-down bed is not resting on obstacles such as cushions or similar.

#### Lifting the pull-down bed:

- Switch off the reading lamps in the pull-down bed.
- Press the arrow key (Fig. 143,1) and keep it pressed until the pull-down bed has moved down into the final upper position.
- Ensure that there are no objects stuck between the roof and the pull-down bed.

**Access assistance** The storage compartment (Fig. 145,2) can be used as an access assistance.

**Emergency operation**

If it is no longer possible to move the pull-down bed with the arrow keys (Fig. 143,1 and 4), first of all check the fuse behind the panelling (Fig. 147,2) (see section 9.10.1). If the fuse is okay and it is still not possible to move the pull-down bed, operate the pull-down bed manually.

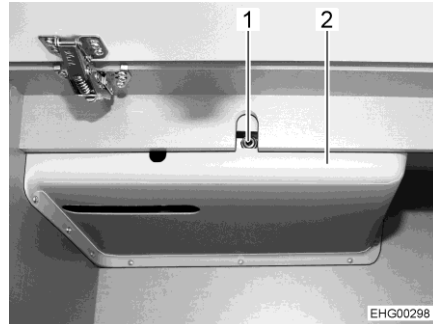

Fig. 147 Access to drive

- Remove mattress from pull-down bed and reduce the load of the storage cupboards to a minimum.
- Insert the crank provided or an Allen wrench into the accommodation on the motor (Fig. 147,1).
- Turn crank or Allen wrench manually until the pull-down bed has reached the upper parking position.

### 7.13.6 Queen size bed, extendable in length (dependent on model)



- ▷ If the extension has been pulled out: do not put the entire body weight on the extension (e.g. do not kneel on it). Do not put the weight of heavy objects onto the extension.

Depending on the ground plan, a queen size bed extendable in length may be installed.



Fig. 148 Queen size bed



Fig. 149 Extension

#### Extending the queen size bed in length:

- Lift the mattress (Fig. 148,1).
- Use the handle (Fig. 149,2) to pull the extension (Fig. 149,1) out as far as it will go.

- Shortening the queen size bed:
- Lift the mattress (Fig. 148,1).
  - Use the handle (Fig. 149,2) to push the extension (Fig. 149,1) in as far as it will go.

## 7.14 Converting seating groups for sleeping

The seating groups installed in the vehicles can be divided into two categories:

- Individual benches which can be converted into the guest bed including the driver's seat.
- Seating groups with a lateral individual seat or lateral bench seat, which can be converted into a transverse bed.

The following table gives an overview of the seating groups installed in the different models and names the section in which the bed conversion is described.



▷ The ground plans for the individual models are shown in chapter 17.

### Limited T

Model	Seating group	Table type	Bed	Section
T/IT 660 Dinette	Individual bench with lateral seat	Suspension table	Transverse bed	7.14.6
T/IT 660 L-SG	L-seating group with lateral seat	Lift-off table	Transverse bed	7.14.7
T/IT 690 Dinette	Individual bench	Suspension table	Guest bed	7.14.1
T/IT 690 L-SG	L-seating group	Suspension table	Guest bed	7.14.1
T/IT 726 Dinette	Individual bench with lateral seat	Suspension table	Transverse bed	7.14.8
T/IT 726 L-SG	L-seating group with lateral seat	Lift-off table	Transverse bed	7.14.9
T/IT 727	2 x individual bench	Lift-off table	Transverse bed	7.14.4

### Lineo T (Ford)

T 620	Individual bench with lateral seat	Lift-off table	Transverse bed	7.14.10
T 690	Individual bench with lateral seat	Lift-off table	Transverse bed	7.14.10
T 700 (H)	Individual bench	Lift-off table	Guest bed	7.14.1



## Lyseo TD (Limited)

Model	Seating group	Table type	Bed	Section
IT 594	2 x individual bench	Lift-off table	Transverse bed	7.14.11
IT 644	Round seating group	Lift-off table	Transverse bed	7.14.5
IT 684	2 x individual bench	Lift-off table	Transverse bed	7.14.4
T/IT 690 Dinette	Individual bench with lateral seat	Suspension table	Transverse bed	7.14.3
T/IT 690 L-SG	L-seating group with lateral seat	Lift-off table	Transverse bed	7.14.2
T/IT 727	2 x individual bench	Lift-off table	Transverse bed	7.14.4
T/IT 732	2 x individual bench	Lift-off table	Transverse bed	7.14.4
T/IT 736	2 x individual bench	Lift-off table	Transverse bed	7.14.4
T/IT 744 Dinette	Individual bench with lateral seat	Suspension table	Transverse bed	7.14.3
T/IT 744 L-SG	L-seating group with lateral seat	Lift-off table	Transverse bed	7.14.2



- ▷ The following representations are partly valid for different vehicles. Therefore, the length, width and form of individual cushions may differ from the ones shown here.

### 7.14.1 Conversion of semi-dinette into guest bed (Limited T/IT 690, Lineo T 700 (H))

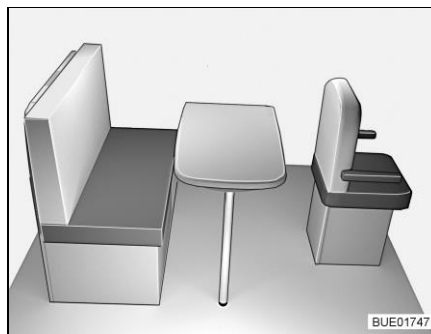

Fig. 150 Prior to conversion

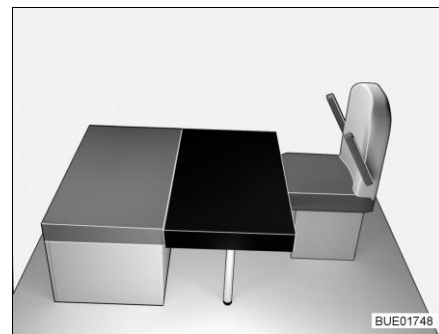

Fig. 151 After conversion

- Rotate the driver's seat towards the table.
- Push driver's seat fully forward (away from the table).
- Convert the suspension table into a bed foundation (see section 7.12).
- Lay the back cushion of the bench aside.
- Place the rectangular additional cushion on the table (in front of the seat cushion of the bench, see Fig. 151). When doing so, the cutout in the additional cushion is located on the frontal supporting wall.



- Push the driver's seat towards the table until a closed lying surface is created.

### 7.14.2 Conversion of L-seating group into transverse bed (with additional cushion table) (Lyseo TD T/IT 690 L-SG, 744 L-SG)

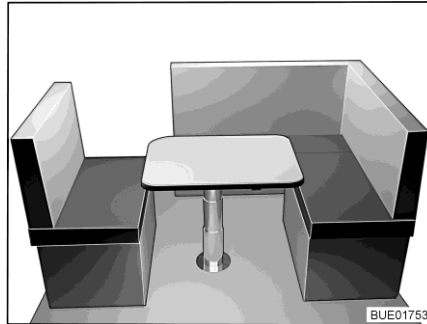

Fig. 152 Prior to conversion

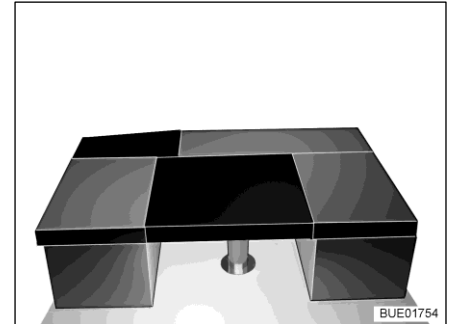

Fig. 153 After conversion

- Convert the lift-off table into a bed foundation (see section 7.12).
- Lay the back cushions of the benches aside.
- Push the cover of the lateral seat/lateral bench towards the centre of the vehicle as far as it will go.
- Place the bed widening onto the cover of the lateral seat/lateral bench and the table and secure it with elastic buffers.
- Place the rectangular additional cushion on the table (between the seat cushions of the benches, see Fig. 153).
- Fully unfold the support underneath the additional cushion with reinforcement plate.
- Hook the hooks on the additional cushion with reinforcement plate into the holders on the bench seat and place the support on the floor.

### 7.14.3 Conversion of semi-dinette into transverse bed (with additional cushion and bed widening) (Lyseo TD T/IT 690 Dinette, 744 Dinette)

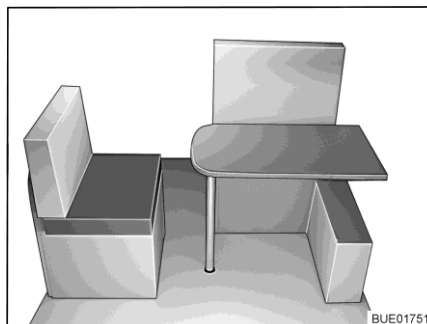

Fig. 154 Prior to conversion

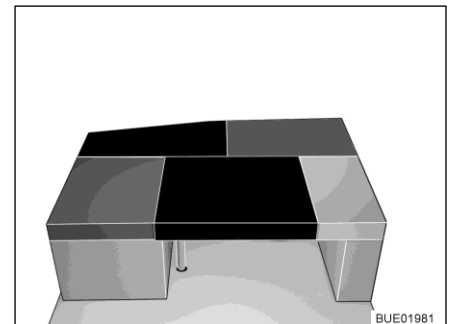

Fig. 155 After conversion

- Convert the suspension table into a bed foundation (see section 7.12).
- Lay the back cushion of the bench aside.

- Push the cover of the lateral seat towards the centre of the vehicle as far as it will go.
- Place the back cushion of the lateral seat on the table.
- Place the rectangular additional cushion on the table (between the seat cushion and the back cushion of the lateral seat, see Fig. 155).
- Fully unfold the support underneath the additional cushion with reinforcement plate.
- Hook the hooks on the additional cushion with reinforcement plate into the holders on the bench and place the support on the floor.

#### 7.14.4 Conversion of facing seating unit into transverse bed (Limited T T/IT 727, Lyseo TD IT 684, T/IT 727, 732, 736)

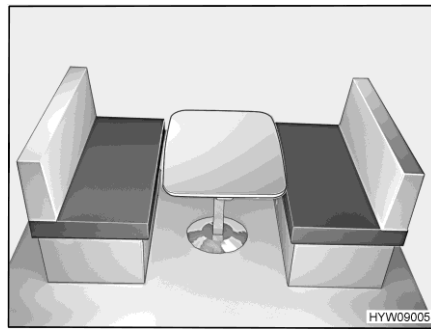

Fig. 156 Prior to conversion

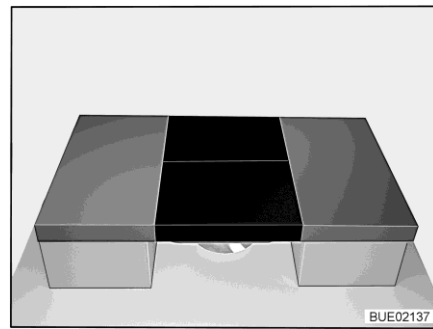

Fig. 157 After conversion

- Convert the lift-off table into a bed foundation (see section 7.12).
- Lay the back cushions of the benches aside.
- Place two additional cushions on the table (see Fig. 157).

#### 7.14.5 Conversion of round seating group to transverse bed (Lyseo TD IT 644)

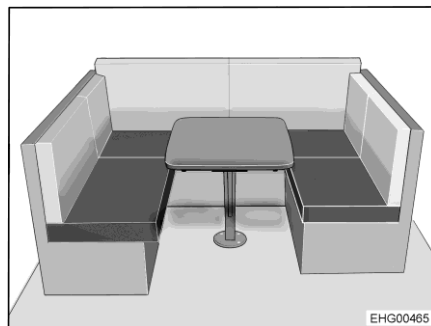

Fig. 158 Prior to conversion

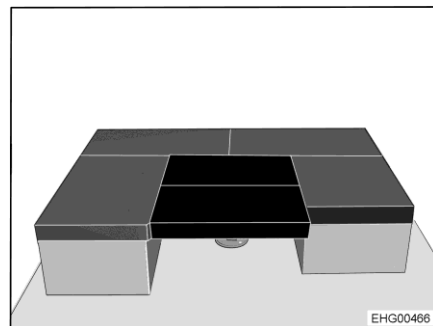

Fig. 159 After conversion

2 additional cushions are required for the conversion.

- Convert the lift-off table into a bed foundation (see section 7.12).
- Remove and store back cushions.
- Place 2 additional cushions transversely on the table (see Fig. 159).

### 7.14.6 Conversion of dinette into transverse bed (individual bench with lateral seat, suspension table) (Limited T T/IT 660 Dinette)

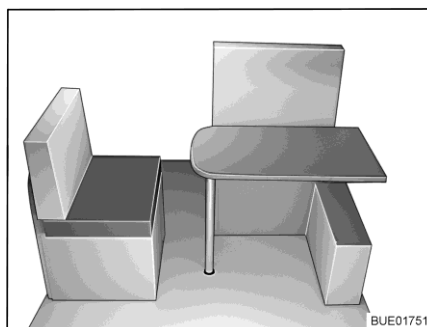

Fig. 160 Prior to conversion

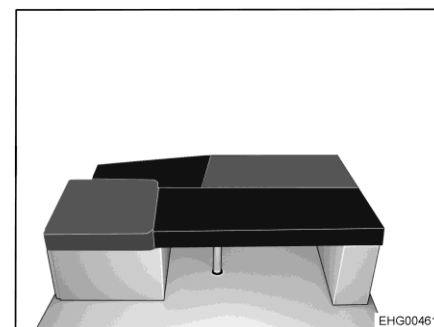

Fig. 161 After conversion



- ▷ A rectangular and a triangular additional cushion are required for the conversion. A long bed widening and a square bed widening are also required. The long bed widening has a fold-out supporting side panel on the underside.
- ▷ There are slats attached to the underside of the bed widenings (two on the long bed widening, one on the square bed widening). These slats must respectively be introduced into the grooves of the resting surfaces (cover of the lateral seat or of the individual bench) when placing the bed widenings. This fixes the bed widenings in their respective positions.
  - Convert the suspension table into a bed foundation (see section 7.12).
  - Remove and store back cushions.
  - Fold out the supporting side panel on the underside of the long bed widening.
  - Place long bed widening between lateral seat and individual bench. When doing this, make sure that one slat of the long bed widening engages in the groove on the cover of the lateral seat and one slat in the groove in the cover of the individual bench.
  - Place square bed widening between lateral seat and table. When doing this, make sure that the slat of the square bed widening engages in the groove in the cover of the lateral seat.
  - Place rectangular additional cushion on the table (see Fig. 161).
  - Place triangular additional cushion on the long bed widening between lateral seat and individual bench (see Fig. 161).

### 7.14.7 Conversion of L-seating group with lateral seat into transverse bed (lift-off table) (Limited T T/IT 660 L-SG)

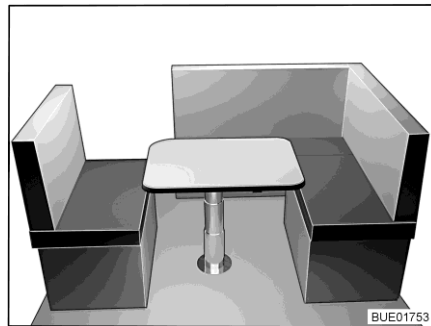

Fig. 162 Prior to conversion

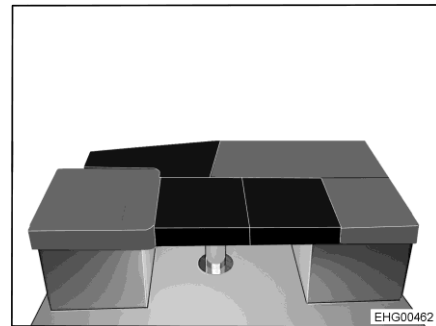

Fig. 163 After conversion



- ▷ 2 square and a triangular additional cushion are required for the conversion. A long bed widening is also needed. The long bed widening has a fold-out supporting side panel on the underside.
- ▷ There are two slats attached to the underside of the long bed widening. These slats must be introduced into the grooves of the resting surfaces (cover of the lateral seat or of the L-shaped bench) when placing the bed widenings. This fixes the bed widening in its position.
- Convert the lift-off table into a bed foundation (see section 7.12).
- Remove and store back cushions.
- Fold out the supporting side panel on the underside of the bed widening.
- Place bed widening between lateral seat and L-shaped bench. When doing this, make sure that one slat of the bed widening engages in the groove on the cover of the lateral seat and one slat in the groove in the cover of the L-shaped bench.
- Place 2 square additional cushions on the table (see Fig. 163).
- Place triangular additional cushion on the bed widening between lateral seat and L-shaped bench (see Fig. 163).

### 7.14.8 Conversion of dinette into transverse bed (Delfin T 726) (individual bench with lateral seat, suspension table) (Limited T T/IT 726 Dinette)

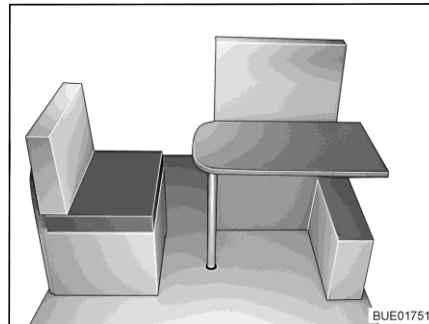

Fig. 164 Prior to conversion

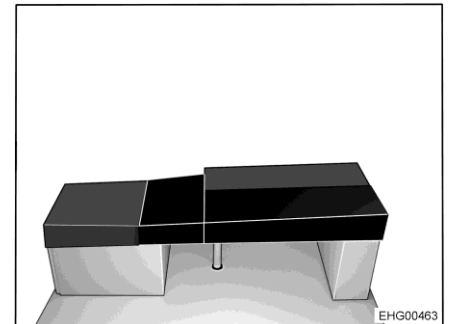

Fig. 165 After conversion



- ▷ A rectangular and an angled additional cushion are required for the conversion. A L-shaped bed widening is also needed.
- ▷ There is a slat attached to the underside of the bed widening. This slat must be introduced into the groove in the cover of the individual bench when placing the bed widening. This fixes the bed widening in its position.
  - Convert the suspension table into a bed foundation (see section 7.12).
  - Remove and store back cushions.
  - Place L-shaped bed widening between lateral seat and individual bench. When doing this, make sure that the slat of the bed widening engages in the groove in the cover of the individual bench. On the cover of the lateral seat, the L-shaped bed widening only lies.
  - Place rectangular additional cushion on the table (see Fig. 165).
  - Place angled additional cushion on the L-shaped bed widening (see Fig. 165).

### 7.14.9 Conversion of L-seating group with lateral seat into transverse bed (lift-off table) (Limited T T/IT 726 L-SG)

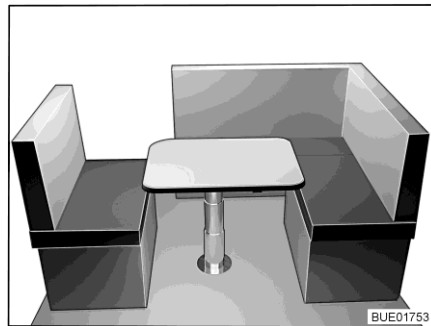

Fig. 166 Prior to conversion

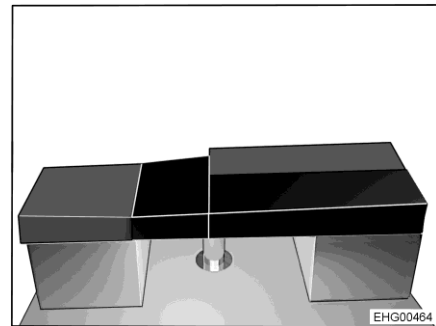

Fig. 167 After conversion



- ▷ A rectangular and an angled additional cushion are required for the conversion. A L-shaped bed widening is also needed.
- ▷ There is a slat attached to the underside of the bed widening. This slat must be introduced into the groove in the cover of the L-shaped bench when placing the bed widening. This fixes the bed widening in its position.
- Convert the lift-off table into a bed foundation (see section 7.12).
- Remove and store back cushions.
- Place L-shaped bed widening between lateral seat and L-shaped bench. When doing this, make sure that the slat of the bed widening engages in the groove in the cover of the L-shaped bench. On the cover of the lateral seat, the L-shaped bed widening only lies.
- Place rectangular additional cushion on the table (see Fig. 167).
- Place angled additional cushion on the L-shaped bed widening (see Fig. 167).

### 7.14.10 Conversion of dinette into transverse bed (individual bench with lateral seat, lift-off table) (Lineo T 620, T 690)

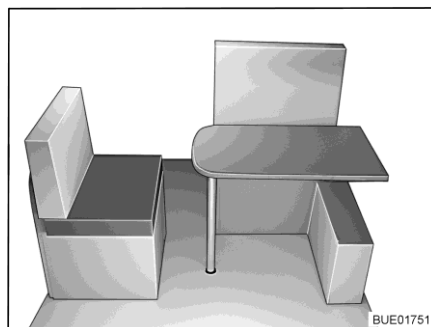

Fig. 168 Prior to conversion

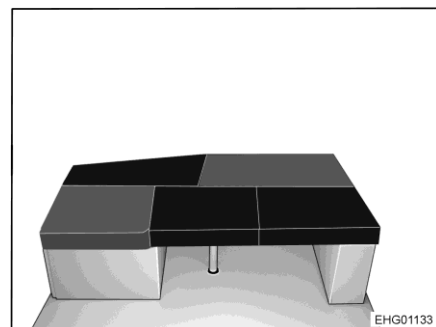

Fig. 169 After conversion



- ▷ Three additional cushions are required for the conversion.
- ▷ A bed widening is also required. The bed widening can be folded and is fitted with a folding side panel and two slats on the underside.

- Convert the lift-off table into a bed foundation (see section 7.12).
- Remove and store the back cushions.
- Fold back the bed widening.
- Place bed widening on lateral seat, lift-off table and individual bench. To this end, lift or remove seat cushion.
- Insert the two slats on the underside of the bed widening into the respective groove of the resting surface of the lateral seat and individual bench.
- Fold out the side panel on the underside of the bed widening.
- Place three additional cushions in line with Fig. 169.

### 7.14.11 Conversion of facing seating unit into transverse bed (lift-off table) (Lyseo TD IT 594)

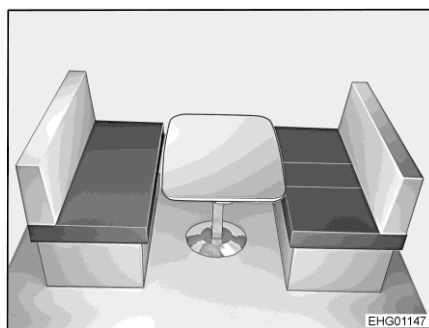

Fig. 170 Prior to conversion

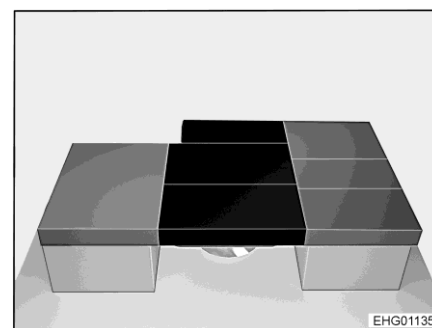

Fig. 171 After conversion



- ▷ Three additional cushions are required for the conversion.
- ▷ A bed widening is also required. The bed widening is fixed onto the resting surface of the window bench and can be folded out.
- Convert the lift-off table into a bed foundation (see section 7.12).
- Remove and store the back cushions.
- Fold back the bed widening.
- Fold out the supporting side panel on the underside of the bed widening.
- Place three additional cushions in line with Fig. 171.

### 7.14.12 Lying surface of single beds

The two single beds in the rear can be converted into a combined lying surface.

The additional cushions are stored in a cabinet underneath the bed.

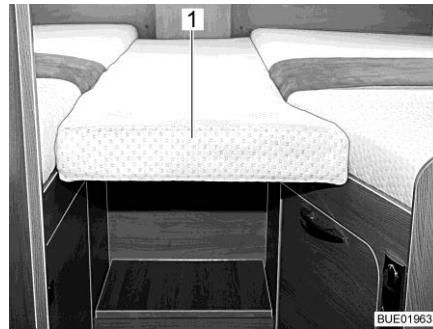

Fig. 172 Additional cushion

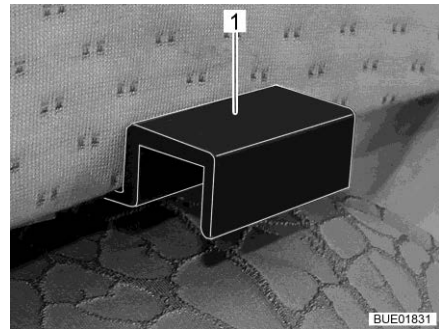

Fig. 173 Additional cushion holder

- Take the additional cushion out of the cabinet.
- Hook the additional cushion (Fig. 172,1) with the holders (Fig. 173,1) into the panels of the single beds so that a closed lying surface is created.

### 7.14.13 Lying surface of single beds (variant)

The two single beds in the rear can be converted into a combined lying surface.

The additional cushions are stored in a cabinet underneath the bed.



Fig. 174 Conversion to lying surface

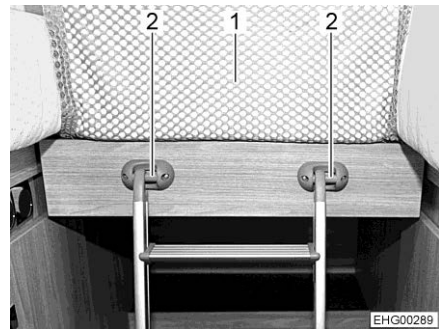

Fig. 175 Access ladder and safety net

- Extend the centre piece (Fig. 174,1) between the beds.
- Take the additional cushion out of the cabinet.
- Place the additional cushion on the centre piece such that a closed lying surface is created.

If brackets (Fig. 175,2) to attach an access ladder and a safety net (Fig. 175,1) are present on the center piece:

- Attach the access ladder to the brackets (Fig. 175,2).
- Set up the safety net (Fig. 175,1).



## 7.15 Rear bed fall out protection

Depending on the type of rear bed installed in the vehicle, the rear bed must be secured with a fall out protection on the windows and at the bottom end.

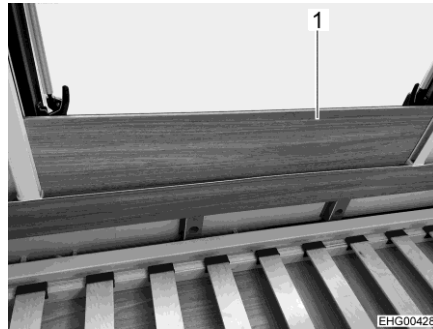

Fig. 176 Fall out protection (window)



Fig. 177 Holder for fall out protection (bottom end)

- Insert fall out protection (Fig. 176,1) between blind guide rail and window frame.
- Insert fall out protection into the holder at the bottom end (Fig. 177,1).

## 7.16 Shower connection point for external shower (optional equipment)



- ▶ Only use the external shower if there is a gap of at least 1.20 m between the shower and the nearest electrical device or connection. Risk of electric shock!



- ▷ If decommissioned for a longer time or if there is a risk of frost, drain the water system.

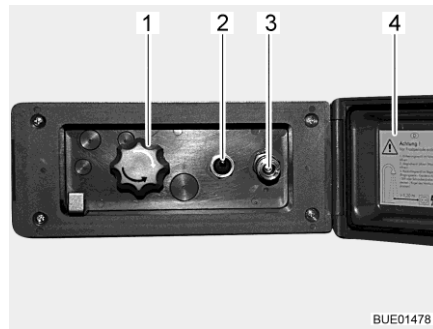

Fig. 178 External shower connection point

**Connecting an external shower:**

- Unlock and open the cover (Fig. 178,4).
- Attach hose of the external shower to the quick closure (Fig. 178,3).

**Using the shower:**

- Switch on the water pump using the switch (Fig. 178,2).
- Adjust the water temperature with the rotary knob (Fig. 178,1) as desired.
- Switch off the water pump using the switch (Fig. 178,2).

**Shutting off the shower connection point:**

- Switch off the water pump using the switch (Fig. 178,2).
- Disconnect the hose from the quick closure. The quick closure is equipped with a check valve to prevent any further water from escaping.
- Close the cover (Fig. 178,4) and lock with key.

**Emptying:**

- Attach hose of external shower to quick closure. The check valve is opened and the connections can run dry.
- Turn knob (Fig. 178,1) to the central position.
- Empty the water system (see section 11.2.7).

## Chapter overview

This chapter contains instructions regarding the gas system of the vehicle. The operation of the gas operation appliances of the vehicle is described in chapter 10.

### 8.1 General



- ▶ The operator of the gas system is responsible for the performance of recurring inspections and for complying with the maintenance intervals.
- ▶ Before commencing the journey, when leaving the vehicle or when the gas devices are not in use, close all gas isolator taps and the main regulator tap on the gas bottle.
- ▶ All gas-operated devices (heater, cooker, oven, grill, refrigerator - depending on the equipment) must be switched off for refuelling, on ferries or in the garage. Danger of explosion!
- ▶ Do not use gas-operated devices in closed spaces (e.g. garages). Danger of poisoning and suffocation!
- ▶ Only have the gas system maintained, repaired or altered by an authorised specialist workshop.
- ▶ Have the gas system checked by an authorised specialist workshop according to the national regulations before commissioning. This also applies for not registered vehicles. For modifications to the gas system have the gas system immediately checked by an authorised specialist workshop.
- ▶ The gas pressure regulator, the gas tubes, and the exhaust gas pipes must also be inspected. The gas pressure regulator and the gas tubes must be replaced observing the nationally defined deadlines (the latest after 10 years). The vehicle owner is responsible for seeing that this is carried out.
- ▶ In case of a defect of the gas system (gas odour, high gas consumption) there is danger of explosion! Close regulator tap on the gas bottle immediately. Open doors and windows and ventilate well.
- ▶ If the gas system is defective: Do not smoke; do not ignite any open flames, and do not operate electric switches (light switches etc.). Check the tightness of gas-conducting parts and lines with leakage search spray. Do not check with an open flame.
- ▶ Only the stipulated devices may be connected to internal connections. Do not operate any device outside the vehicle if it is connected to an internal connector.
- ▶ Before using the cooker make sure that there is sufficient ventilation. Open a window or the skylight.
- ▶ Cooking is prohibited during the journey.
- ▶ Do not use gas-operated cooking and baking facilities for heating purposes.
- ▶ If there are several gas devices, each gas device must have its own gas isolator tap. If individual gas devices are not in use, close the respective gas isolator tap.



- ▶ Ignition safety valves must close within 1 minute after the gas flame has extinguished. A clicking sound is audible. Check function from time to time.
- ▶ The built-in gas devices are exclusively meant for use with propane or butane gas or a mixture of both. The gas pressure regulator as well as all built-in gas devices are designed for a gas pressure of 30 mbar.
- ▶ Propane gas is capable of gasification up to -42 °C, whereas butane gas gasifies at 0 °C. Below these temperatures no gas pressure is available. Butane gas is unsuitable for use in winter.
- ▶ Due to its function and construction, the gas bottle compartment is a space which is open to the exterior. Never cover or block up the standard forced ventilations. Otherwise gas that is emitted can not be diverted to the outside.
- ▶ The gas bottle compartment must not be used as storage space.
- ▶ Secure the gas bottle compartment against unauthorised access. To do this, lock the compartment.
- ▶ The regulator tap on the gas bottle must be accessible.
- ▶ Only connect gas-operated devices which have been designed for a gas pressure of 30 mbar.
- ▶ The exhaust gas pipe must be fitted tightly to the heating system and to the vent and must be sealed. The exhaust gas pipe must not show any evidence of damage.
- ▶ Exhaust fumes must be able to escape into the atmosphere unhindered and fresh air must be able to enter unhindered. For this reason, keep the exhaust pipe and intake openings clean and unobstructed (e.g. free from snow and ice). For this reason, no snow walls or aprons may lie against the vehicle.

## 8.2 Gas bottles



- ▶ Handle full or emptied gas bottles outside the vehicle only with closed regulator tap and attached protective cap.
- ▶ Gas bottles are only to be transported within the designated gas bottle compartment.
- ▶ Place the gas bottles in vertical position in the gas bottle compartment.
- ▶ Fasten the gas bottles so that they are unable to turn or tilt.
- ▶ Connect the gas tube to the gas bottle without tension.
- ▶ If the gas bottles are not connected to the gas tube, always place the protective cap on top.
- ▶ Close the regulator tap on the gas bottle before the gas pressure regulator or gas tube are removed from the gas bottle.
- ▶ Depending on the connection, unscrew the gas tube from the gas bottle and screw it on the gas bottle again by hand or using a suitable special spanner. The screw connection on the gas bottle generally has a left-hand thread. **Do not** tighten too firmly.



- ▶ Only use special gas pressure regulators with a safety valve designed for vehicle use. Other gas pressure regulators are not permitted and cannot meet the demanding requirements.
- ▶ Use only 11 kg or 5 kg gas bottles. (Gas bottle sizes may vary depending on the country.) Camping gas bottles with built-in check valve (blue bottle with max. 2.5 or 3 kg content) are can be used in exceptional cases with a safety valve.
- ▶ Use the shortest possible tube lengths (150 cm max.) for external gas bottles.
- ▶ Never block the floor ventilation openings below the gas bottles.



- ▷ With some models, the gas bottle compartment is located right next to the conversion door. With these models, only open the gas bottle compartment when the conversion door is closed. Danger from damages.



- ▷ The screw connections on the gas bottles generally have a left-hand thread.
- ▷ For gas-operated units the gas pressure must be reduced to 30 mbar.
- ▷ Connect gas pressure regulator complete with safety valve directly to bottle valve.  
The gas pressure regulator reduces the gas pressure in the gas bottle down to the operating pressure of the gas devices.
- ▷ For filling and connecting the gas bottles in Europe the accessories shops have corresponding Euro filling sets and Euro bottle sets.
- ▷ Information available at the dealers or service centre.
- ▷ For information on the gas supply in Europe see chapter 18.

The gas pressure regulator is permanently installed in the gas bottle compartment. The gas bottle is connected to the gas pressure regulator via a high-pressure gas hose.

The high-pressure gas hoses and their connections are different in the various countries. The accessories shop offers the respective country-specific models and adapters.

### 8.3 Gas isolator taps

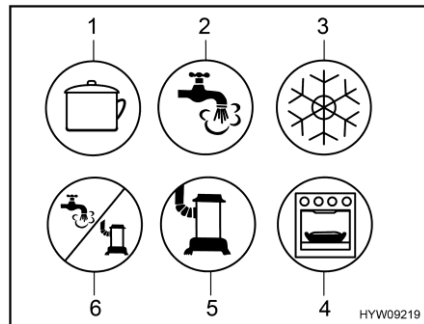

- 1 Cooker
- 2 Hot water
- 3 Refrigerator
- 4 Oven/grill
- 5 Heater
- 6 Hot water/heater

Fig. 179 Possible symbols for the gas isolator taps

A gas isolator tap (Fig. 179) for every gas device is built into the vehicle.

The gas isolator taps are located in the vehicle at different positions, and can also be fitted separately. Generally, you will have access to the gas isolator taps in the kitchen unit opening a door or a drawer.

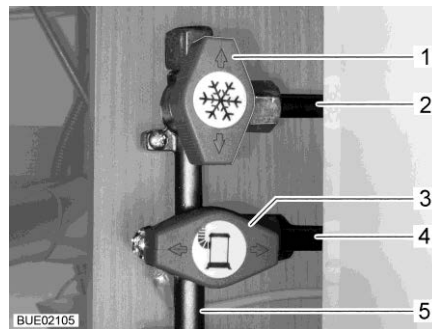

Fig. 180 Gas isolator taps position (example)

- 1 Gas isolator tap for refrigerator closed
- 2 Pipe to refrigerator
- 3 Heater gas isolator tap open
- 4 Pipe to heater
- 5 Gas pipe from gas bottle

**Opening:** ■ Position the gas isolator tap of the corresponding gas device parallel (Fig. 180,3) to the pipe (Fig. 180,4) leading to the gas device.

**Closing:** ■ Position the gas isolator tap of the corresponding gas device transverse (Fig. 180,1) to the pipe (Fig. 180,2) leading to the gas device.

## 8.4 External gas connection (optional equipment)



- ▶ If the external gas connection is not in use, always close the gas isolator tap.
- ▶ Only gas appliances with a suitable adapter should be connected to the external gas connection.
- ▶ Connect only external gas appliances which are designed for an operation pressure of 30 mbar.
- ▶ Once you have made the connection and opened the gas isolator tap, make sure that no gas is escaping at the connection point. If there is a leak in the external gas connection, gas will escape into the open air. Immediately close the gas isolator tap and the regulator tap on the gas bottle. Have the external gas connection checked by an authorised specialist workshop.
- ▶ When connecting an external gas appliance, make sure that there is nothing near the external gas connection that could cause a spark.
- ▶ Only connect a gas appliance to the external gas connection. Do not use the external gas connection as supply (connection of an additional gas bottle).
- ▶ Do not use the external gas connection to fill gas bottles. Observe the information stickers on the external gas connection.

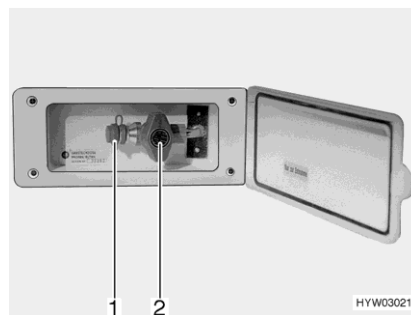

Fig. 181 External gas connection  
(gas isolator tap closed)

The external gas connection is located on the right-hand side of the vehicle.

- Connect the external gas device to the connection point (Fig. 181,1).
- Open the gas isolator tap (Fig. 181,2).

### 8.5 Gas bottle switching facility (optional equipment)



- ▶ If the vehicle is equipped with a gas bottle switching facility without Crash Protection Unit (CPU), it is not permitted to operate gas devices during the journey. Close the regulator taps on the gas bottles and the gas isolator taps before setting off.



- ▷ When the vehicle is equipped with the crash protection unit the living area heater may be operated during the journey.
- ▷ The gas bottle switching facility and the hose lines shall be changed at the latest 10 years after manufacturing date. The operator is responsible for this.

The automatic switching facility automatically switches gas supply from the primary bottle to the reserve bottle as soon as the primary bottle is either empty or no longer ready for operation. The gas appliances may still continue operation. The switching facility is suitable for all commercial gas bottles from 3 kg to 33 kg.

#### Facility without Crash Protection Unit (CPU)

The gas bottle switching facility consists of a combined gas pressure regulator with reversing valve and indicator (Fig. 182,3). The gas bottle switching facility is installed between the two gas tubes (Fig. 182,1).

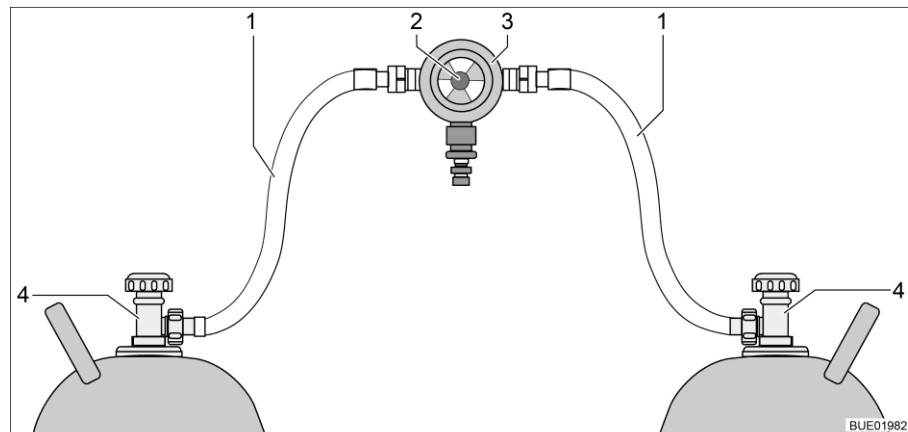

Fig. 182 Gas bottle switching facility

- 1 Gas tube
- 2 Knob for manual switching of the gas bottles
- 3 Gas pressure regulator with reversing valve and indicator
- 4 Regulator tap on the gas bottle

#### Facility with Crash Protection Unit (CPU)

The gas bottle switching facility consists of a combined gas pressure regulator with reversing valve and indicator (Fig. 183,4), and an electrovalve (Fig. 183,2). The electrovalve blocks the gas supply to the vehicle in the event of a full braking, an accident, or an unusually great inclined position. The gas bottle switching facility is installed between the two gas tubes (Fig. 183,1) with hose break guards (Fig. 183,5).



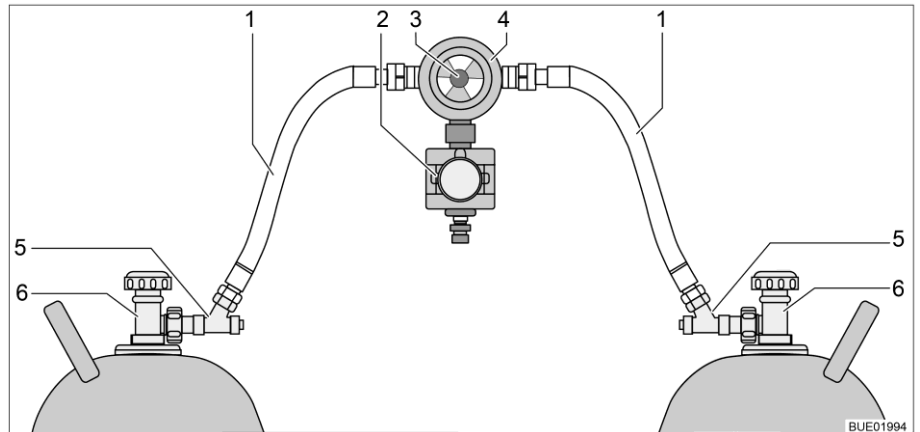

Fig. 183 Gas bottle switching facility with CPU

- 1 Gas tube
- 2 Electrovalve (CPU)
- 3 Knob for manual switching of the gas bottles
- 4 Gas pressure regulator with reversing valve and indicator
- 5 Hose break guard
- 6 Regulator tap on the gas bottle

### Function

The gas bottle switching facility ensures a constant gas pressure, regardless of which gas bottle is being drawn upon. The display in the reversing valve shows the filling level of the primary bottle. The gas supply comes from the primary bottle when the display is green. When the display is red the primary bottle is empty. In this case, the reserve bottle is used for the gas supply.

Use the knob (Fig. 182,2 or Fig. 183,3) on the gas bottle switching facility to select which of the gas bottles is to be used as a primary bottle and which is to be used as a reserve bottle.

### Operating unit

Depending on the equipment, the gas bottle switching facility is additionally equipped with an electrical operating unit (with or without remote display).



Fig. 184 Operating unit



Fig. 185 Operating unit with remote display

Only the electrical functions can be switched at the operating unit (Fig. 184). The regulator taps on the gas bottles (Fig. 182,4 or Fig. 183,6) must be opened and closed manually.

**Without remote display** The indicator lamp on the operating unit shows the condition of the gas system. The system is okay when the indicator lamp (Fig. 184,1) lights up green. When the indicator lamp lights up or flashes red a fault has occurred. The gas supply is interrupted.

**With remote display** The indicator lamp on the operating unit (Fig. 185,1) shows the condition of the gas system:

Indicator lamp	Signification
Off	System switched off, gas supply switched off
Green	System switched on, gas supply switched on
Red	Gas supply switched off, triggered by sloping position or excessive acceleration, e.g. in the event of an accident
Yellow	System switched on, gas supply switched on, primary bottle empty
Flashes yellow	Self-check, for approx. 2 seconds, after switching on
Flashes red once	Valve not connected to control unit or internal error
Flashes red twice	Overvoltage determined, gas supply interrupted
Flashes red three times	Undervoltage determined, gas supply interrupted

**Putting into operation:**

- Open the regulator taps of the gas bottles (Fig. 182,4 or Fig. 183,6).
- Press the hose break guards (Fig. 183,5) successively for 10 seconds.
- Use the knob (Fig. 182,2 or Fig. 183,3) on the switching facility to select the gas bottle which is to be the primary source of gas (primary bottle). Always turn the knob as far as it will go.
- Switch on the switching facility on the operating unit. For this, set the rocker switch (Fig. 184,2 or Fig. 185,2) to "ON". The reversing valve is now deaerated. The indicator lamp (Fig. 184,1 or Fig. 185,1) flashes yellow (system test) and lights up green.

**Switching off:**

- Set the rocker switch (Fig. 184,2 or Fig. 185,2) to "OFF". The indicator lamp (Fig. 184,1 or Fig. 185,1) goes out.
- Close the regulator taps of the gas bottles (Fig. 182,4 or Fig. 183,6).



- ▶ When changing gas bottles, do not smoke or create any open fire.
- ▶ Depending on the connection, unscrew the gas tube from the gas bottle and screw it on the gas bottle again by hand or using a suitable special spanner. The screw connection on the gas bottle generally has a left-hand thread. **Do not** tighten too firmly.

**Changing gas bottles:**

- Change the position of the knob of the switching facility. The display is green again. Should the display stay red the reserve bottle is also empty and has to be changed as well.
- Close regulator tap on the empty gas bottle.
- Unscrew the gas tube of the gas bottle.
- Attach the protective cap to the gas bottle.
- Release the fixing belts and remove the gas bottle.
- Place a new gas bottle in the gas bottle compartment.

- Fix gas bottle in place with the fixing belts.
- Remove the protective cap from the gas bottle.
- Connect the full gas bottle to the gas tube.
- Open the regulator tap on the gas bottle.
- Press the hose break guard for 10 seconds.
- Turn the knob on the reversing valve to the changed bottle. Open the release button when the display is green.
- Set the knob on the reversing valve with a half-turn, so that the newly replaced gas bottle will serve as a reserve bottle.

## 8.6 Changing gas bottles



- ▶ When changing gas bottles, do not smoke or create any open fire.
- ▶ Depending on the connection, unscrew the gas tube from the gas bottle and screw it on the gas bottle again by hand or using a suitable special spanner. The screw connection on the gas bottle generally has a left-hand thread. **Do not** tighten too firmly.
- ▶ When you have changed the gas bottle, check whether gas escapes at the connection points and unions. Use a leakage search spray to spray the relevant connection point or union. These agents are available at the accessories shop.

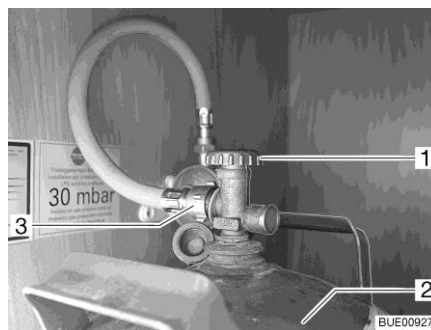

Fig. 186 Gas bottle compartment

- Open the external flap for the gas bottle compartment (see chapter 7).
- Close the regulator tap (Fig. 186,1) on the gas bottle (Fig. 186,2). Pay attention to the direction of the arrow.
- Unscrew the gas tube (Fig. 186,3) from the gas bottle.
- Attach the protective cap to the gas bottle.
- Release the fixing belts and remove the gas bottle.
- Place a filled gas bottle in the gas bottle compartment.
- Fix gas bottle in place with the fixing belts.
- Remove the protective cap from the gas bottle.
- Screw the gas tube onto the gas bottle.
- Close the external flap for the gas bottle compartment.



## Chapter overview

This chapter contains instructions regarding the electrical system of the vehicle.

The operation of the electrical appliances of the housing body is described in chapter 10.

### 9.1 General safety instructions



- ▶ Only allow qualified personnel to work on the electrical system.
- ▶ All electronic devices (e.g. mobile telephones, radios, televisions or DVD players) which have been retrofitted to the vehicle and are operated during the journey must have certain features: These are the CE certification, the EMC inspection (electromagnetic compatibility) and the "e"-inspection.  
Only in this way can the functional reliability of the vehicle be ensured. Otherwise the airbag may be triggered or interference to the on-board electronics may result.



- ▷ After the vehicle is started, delays to the output or forwarding of electrical impulses are possible.  
The control unit of the basic vehicle does not release the D+ signal until the engine has reached full performance. In the event of a cold start in winter, this can take up to 15 seconds.  
For this reason, output of warning signals (such as "entrance step extended") may sometimes be delayed.  
The automatic retraction of a SAT antenna can also be delayed.
- ▷ During a storm, to protect the electrical devices disconnect the 230 V connection and retract the antennae.

### 9.2 Terms

#### Off-load voltage

The off-load voltage is the voltage of the battery in idle condition, i. e. no current is consumed and the battery is not being charged.



- ▷ The battery must remain idle for a while before measuring. After charging the last time, or after the last current has been drained by appliances, wait approximately 2 hours before measuring the off-load voltage.

#### Closed circuit current

Some electrical appliances, such as the clock and the indicator lamps, require continuous electric current, for this reason they are referred to as inactive appliances. This closed circuit current flows even if the device has been switched off.

**Total discharge** Total discharge of the battery is imminent, if a battery is completely discharged by an active appliance and by closed circuit current and the off-load voltage falls below 12 V.



- ▷ Total discharge damages the battery.

**Capacity** Capacity refers to the amount of electricity which can be stored in a battery. The capacity of a battery is given in ampere hours (Ah). The so-called K20 value is normally used.

The K20 value indicates how much current a battery is able to dispense over a time period of 20 hours without causing damage, or how much current is required to charge a flat battery within 20 hours.

For example, if a battery can dispense 4 amps for 20 hours, then it has a capacity of  $4 \text{ A} \times 20 \text{ h} = 80 \text{ Ah}$ .

If more current flows, the discharging time of the battery will decrease proportionately.

External influences, such as temperature and age may alter the storage capacity of the battery. Capacity details refer to new batteries operating at room temperature.



- ▷ Depending on battery technology, capacity details have a conversion factor of 1.3 to 1.7, which lowers the real capacity by this value.

### 9.3 USB socket (partially optional equipment)



- ▷ The charging current is maximum 1 amp.

The vehicle is equipped with one or more USB sockets.

If the vehicle is equipped with a rail system, the housing with the USB socket (Fig. 188,1) can be attached at various positions as necessary.

All USB devices can be connected and charged via this USB socket.



Fig. 187 USB socket

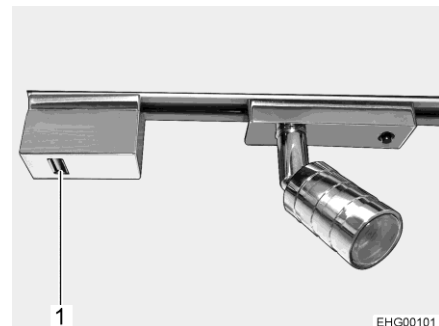

Fig. 188 USB socket on rail system

## 9.4 12 V power supply



- ▷ Only connect devices with a maximum of 10 A to the sockets (Fig. 189,1) of the 12 V power supply.

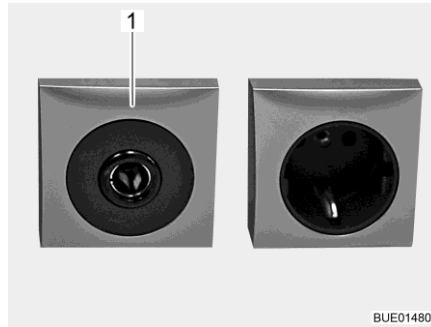

Fig. 189 12 V/10 A socket

### 9.4.1 Starter battery

The starter battery serves for starting the engine and supplies the electrical appliances of the base vehicle as well as optional devices such as the radio, navigation system or central locking system with voltage.



- ▷ Total discharge damages the battery. The consequence may be deformation, heat development, and damage due to scorching.
- ▷ Once a battery with acid is discharged, it can freeze in temperatures of below zero. This damages the battery.
- ▷ Recharge battery in good time.

The starter battery will be totally discharged via a closed circuit current (inactive appliances). Inactive appliances are optional devices such as a radio, alarm system, navigation system or a central locking system. Inactive appliances discharge the starter battery when the vehicle engine is switched off. Low temperatures outside reduce the capacity available.

**Charging** Safety instructions and information on charging the starter battery, see instruction manual of the base vehicle.

**Position** See instruction manual of the base vehicle.

### 9.4.2 Living area battery



- ▷ Use only the built-in transformer/rectifier to load the living area battery. In order to do this, connect the 230 V connection (CEE connector) of the vehicle to an external 230 V power supply.
- ▷ After the trip, charge the living area battery fully.
- ▷ Before a temporary lay-up, charge the battery fully.
- ▷ When the living area battery is changed, only use batteries of the same type and the same capacity.
- ▷ If there are several living area batteries, always change all the batteries together. The batteries must **always** be the same age and have the same capacity.
- ▷ When changing the living area battery, use only batteries which meet the minimum capacity of the charger. Observe the separate instruction manual for the charger. Lower-capacity batteries will generate a great deal of heat when they are charged. Danger of explosion!
- ▷ If the living area battery is replaced and the charging unit does not provide at least 10 % of the rating of a new battery, install an auxiliary charging unit. Example: With a battery capacity of 80 Ah, the charging unit must supply at least 8 A charging current.
- ▷ Before disconnecting or connecting the terminals of the battery, switch off the vehicle engine as well as the 230 V and 12 V power supplies and all appliances. Danger of short circuit!
- ▷ If the starter battery or living area battery are disconnected, do not apply the ignition. There is a danger of short circuit from exposed cable ends.
- ▷ Take note of the battery manufacturer's users and maintenance instructions.



- ▷ If possible, begin the trip with a fully charged living area battery. Therefore, charge the living area battery before starting the trip.
- ▷ During the trip, use every available opportunity to charge the living area battery.
- ▷ The radio device in the driver's cabin is connected to the living area battery.
- ▷ The battery is maintenance-free. Maintenance-free means:
  - It is not necessary to check the acid level.
  - It is not necessary to lubricate the battery poles.
  - It is not necessary to refill the distilled water.
 Even a maintenance-free battery must be recharged.
 

Recommendation: Perform a full charging cycle every 6 to 8 weeks. Depending on the battery capacity and the charger, the charging cycle will last 24 to 48 hours.

When the vehicle is not connected to the 230 V power supply or the 230 V power supply is switched off, the living area battery supplies the living area with 12 V DC. The living area battery has a limited power supply only. For this reason, electrical appliances such as the radio and the lights should not be operated for a long time without using the 230 V power supply.



**Position** See chapter 17.

**Discharging** The living area battery is discharged by the closed circuit current which some electrical appliances continuously require.



- ▷ Total discharge damages the battery.
- ▷ Recharge battery in good time.



- ▷ Appliances such as the refrigerator, charger, solar charge regulator, panel, or similar, take power from the battery, even when the 12 V main switch is turned off. Therefore disconnect the living area battery from the 12 V power supply, if the vehicle will not be used for a long period of time.

Even a completely charged living area battery can, after an extended period, be fully discharged via a closed-circuit current (inactive appliances).

Low temperatures outside reduce the capacity available.

The self-discharge rate of the battery is also dependant on temperature. At 20 to 25 °C the self-discharge rate is approx. 3 % of the capacity per month. The self-discharge rate will increase with rising temperatures.

An older battery no longer has the complete capacity available.

The higher the number of active electrical appliances, the faster the energy of the living area battery is consumed.

#### Particularities of the lithium battery

- The lithium battery has integrated short-circuit protection.
- With the free "BeInCharge" app, the charging status, charging time and charging condition of the battery can be displayed on a mobile device at any time. The app is available for both iOS and Android.
- The "Battery selection" switch on the transformer/rectifier must have been set to "Gel".
- If the vehicle has **one** living area battery, the "Battery type" switch on the charge booster WA 121525 must be set to "Lithium". If the vehicle has **two** living area batteries, the charge booster WA 121545 is preset to lithium batteries.
- **No** air discharge hose may be connected to the lithium battery (in contrast to an AGM battery).



- ▷ Refer to the manufacturer's instruction manual for further information.

### 9.4.3 Charging batteries via a 230 V power supply

If the vehicle is connected to the 230 V power supply, the living area battery and the starter battery are automatically charged by the charger module on the transformer/rectifier. The starter battery is only charged with a float charge. The charging current is adapted to suit the charging condition of the battery. This ensures that it is not possible to overload the battery.

To make use of the maximum output from the charger module on the transformer/rectifier, switch off all electrical appliances during charging.

#### 9.4.4 Charging batteries via the vehicle engine (alternator)

When the vehicle engine is running, the vehicle alternator recharges the living area battery and the starter battery. When the vehicle engine is switched off, the batteries are automatically disconnected from one another by a relay in the transformer/rectifier. This prevents the starter battery from being run down by electrical appliances in the living area. The starting capability of the vehicle is thus preserved. The charging condition of the living area battery or the starter battery can be read on the panel.

#### 9.5 Charging booster for the living area battery



- ▶ Do not carry out any maintenance or repair work on the device. There is an electrical shock hazard and risk of fire.
- ▶ If the housing or the cables are damaged: do not put the device into operation. Disconnect device from the power supply.
- ▶ Make sure that no liquids enter the device.
- ▶ Device components can get hot during operation. Do not touch the device.  
Do not store any heat sensitive objects close to the device.



- ▷ Only use battery types as living area battery which are supported by the charging booster.
- ▷ In the event of a change of battery type: have the charging booster reset and re-programmed at a service centre.

During the journey, the living area battery is charged by the vehicle's alternator. Fluctuations in the charging current and a drop in voltage between the alternator and the living area battery affect the battery's performance. The charging booster is used to keep the charging current of the alternator constant and to compensate for any drops in voltage.

The charging booster has been set in the factory for the living area battery used and works automatically. No operating actions are required.

In the event of a high heat development, a built-in fan prevents the charging booster from overheating.

For any information about the fuse of the voltage sensor, see section 9.10.1.

**Position** The charging booster is installed underneath the driver's seat (next to the transformer/rectifier).

## 9.6 Transformer/rectifier (EBL 119/EBL 99)



- ▷ Do not cover the ventilation slots. Danger of overheating!



- ▷ Depending on the model, not all slots for the fuses are occupied.
- ▷ Deviating from the default assignment, the following fuse values are inserted:  
"Basic light/entrance step": 20 A  
"Spare 3": 10 A (fuse for USB socket)
- ▷ Further information can be obtained in the manufacturer's instruction manual.

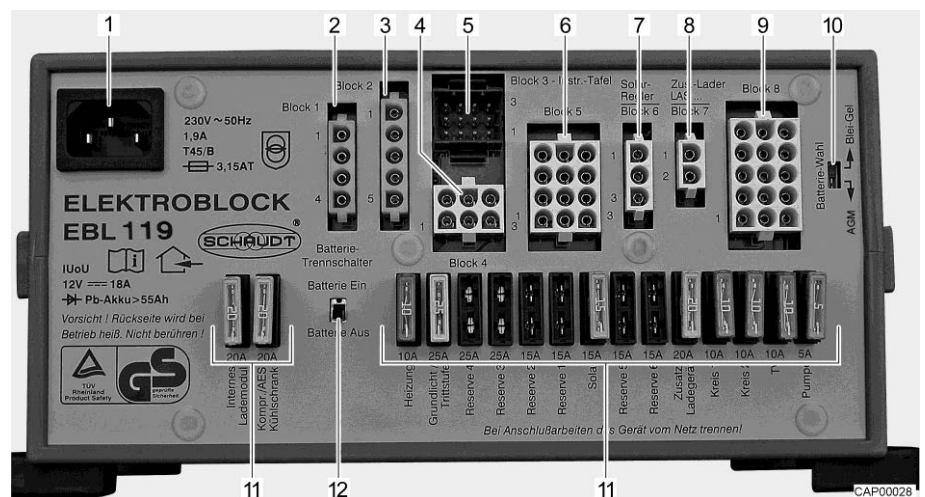

Fig. 190 Transformer/rectifier (EBL 119, as an example)

- 1 Main supply socket 230 V~
- 2 Output: Block 1 – refrigerator
- 3 Input: Block 2 – control lines
- 4 Output: Block 4 – heater, safety/drainage valve, basic light (lighting in the entrance area), entrance step
- 5 Output: Block 3 – panel
- 6 Output: Block 5 – solar cell (if fitted), spare 2, spare 3, spare 4
- 7 Output: Block 6 – solar charge regulator (if fitted)
- 8 Output: Block 7 – auxiliary charging unit
- 9 Output: Block 8 – consumer circuit 1, consumer circuit 2, 12 V socket, water pump, spare 1, spare 5, spare 6
- 10 EBL 119: Battery selector switch ("Blei-Gel/AGM" (lead-gel/AGM))  
EBL 99: Battery selector switch ("Blei-Säure/Blei-Gel" (lead acid/lead-gel))
- 11 Fuses
- 12 Battery cut-off switch ("Batterie Ein/Aus" (battery On/Off))



- ▷ Except for the battery selector switch (Fig. 190,10), the transformer/rectifier EBL 99 and the transformer/rectifier EBL 119 have the same design.

- Functions** The transformer/rectifier has the following functions:
- The transformer/rectifier charges the living area battery. The transformer/rectifier charges the starter battery with a float charge only.
  - The transformer/rectifier monitors the voltage in the living area battery.
  - The transformer/rectifier distributes the current to the 12 V circuits and secures them. Devices with a maximum of 10 A can be connected to the sockets.
  - The transformer/rectifier provides connections for a solar charge regulator, an auxiliary charging unit, as well as other control and monitoring functions.
  - When the vehicle engine is turned off, the transformer/rectifier separates the starter battery electrically from the living area battery. This prevents the 12 V living area appliances from discharging the starter battery.
  - The battery cut-off switch in the transformer/rectifier separates all the appliances from the living area battery.

The transformer/rectifier only works in conjunction with a panel.

When the transformer/rectifier is subject to a heavy load, the fitted charger module reduces the charging current. This protects the charger from overheating. The transformer/rectifier is subject to a heavy load when e.g. an empty living area battery is being charged, additional electrical appliances are turned on and the ambient temperatures are high.

**Position** See chapter 17.

### 9.6.1 Battery cut-off switch



- ▷ After switching the battery cut-off switch back on again: Put the basic light (lighting in the entrance area), entrance step, heater and spare 4 back into service (depending on the model). To do so, switch on the 12 V main switch briefly. This also applies if the living area battery was disconnected and then reconnected.

The battery cut-off switch disconnects all the living area 12 V appliances. This prevents the living area battery from slowly discharging if the vehicle is not used for a longer period of time (e.g. temporary lay-up).

The batteries can still be charged by the transformer/rectifier when the battery cut-off switch is turned off.

- Switching on/off:**
- Push the battery cut-off switch upwards: Battery On ("Batterie Ein").
  - Push the battery cut-off switch downwards: Battery Off ("Batterie Aus").

### 9.6.2 Battery selector switch



- ▶ If the battery selector switch is set incorrectly, there is a risk of generating oxyhydrogen gas. Danger of explosion!



- ▷ Incorrect setting of the battery selector switch damages the living area battery.
- ▷ The factory settings of the battery selector switch must not be changed.

**Position** The battery selector switch is located on the transformer/rectifier.

### 9.6.3 Battery monitor



- ▷ You must fully recharge a discharged living area battery as soon as possible.

The battery monitor in the transformer/rectifier monitors the voltage in the living area battery.

If the voltage of the batteries falls below 10.5 V, the battery monitor in the transformer/rectifier switches off all the 12 V appliances.

- Measures:**
- Switch off all electrical appliances that are not absolutely essential at the corresponding switch.
  - If necessary, use the 12 V main switch to switch the 12 V power supply back on for a short while. This is only possible, however, when the battery voltage is above 11 V. If the voltage is below this level, the 12 V power supply cannot be switched on again until the living area battery has been recharged.

### 9.6.4 Charging the battery

When the vehicle engine is running, a relay in the transformer/rectifier alternator switches on the living area battery and the starter battery together and recharges them with the vehicle generator. When the vehicle engine is switched off, the batteries are automatically disconnected from one another again by the transformer/rectifier. This prevents the starter battery from being run down by electrical appliances in the living area. The starting capability of the vehicle is thus preserved. The terminal voltage of the living area battery or the starter battery can be read on the panel.

If the vehicle is connected to the 230 V power supply via the CEE socket outlet, the living area battery and the starter battery are charged by the charger module on the transformer/rectifier. The starter battery is only charged with a float charge. The charging current is adapted to suit the charging condition of the battery. This ensures that it is not possible to overload the battery.

To make use of the maximum output from the charger module on the transformer/rectifier, switch off all electrical appliances during charging.

## 9.7 Panel LT 96

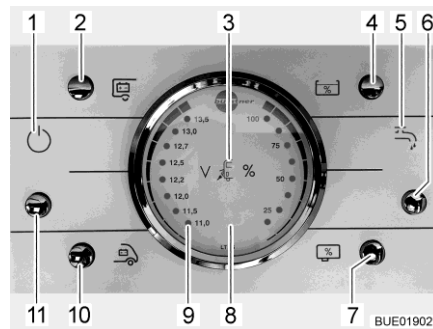

Fig. 191 Panel LT 96

- 1 12 V indicator lamp
- 2 Button for reading the battery voltage of the living area battery
- 3 230 V indicator lamp
- 4 Button for reading the filling level in the water tank
- 5 Indicator lamp water pump
- 6 Button for water pump (On/Off)
- 7 Button for reading the filling level in the waste water tank
- 8 V/tank gauge
- 9 "ALARM" warning light for the living area battery
- 10 Button for reading the battery voltage of the starter battery
- 11 Button for 12 V power supply (On/Off)

### 9.7.1 Button for 12 V power supply

The button (Fig. 191,11) switches the panel and the 12 V power supply to the living area on and off.

Exception: Depending on the model, heater, basic light (lighting in the entrance area), entrance step, spare 4 and a refrigerator with automatic power selection system (AES) remain ready to operate.

**Switching on:** ■ Press the button (Fig. 191,11): The 12 V living area power supply is switched on. The indicator lamp (Fig. 191,1) lights up.

**Switching off:** ■ Press the button (Fig. 191,11): The 12 V living area power supply is switched off. The indicator lamp (Fig. 191,1) goes out.



- ▷ When leaving the vehicle, switch off the main 12 V power supply at the panel. This prevents any unnecessary discharge of the living area battery.
- ▷ Appliances, such as control units (e.g. solar charge regulator, defroster or panel) or fitted appliances (e.g. heater, refrigerator or step) continue to take power from the battery capacity, even if the 12 V power supply on the panel is switched off. Therefore disconnect the living area battery from the 12 V power supply via the switch on the transformer/rectifier if the vehicle will not be used for a long period of time.

### 9.7.2 V/tank gauge for battery voltage and water or waste water levels

**Battery voltage** The V/tank gauge is for the indication of the battery voltage of the starter battery or the living area battery.

With the V/tank gauge (Fig. 191,8), note the left scale. The gauge automatically lights up as soon as a button is pressed.

- Displays:**
- Press the button (Fig. 191,10): The battery voltage of the starter battery is displayed.
  - Press the button (Fig. 191,2): The battery voltage of the living area battery is displayed.

The following tables will help you correctly interpret the battery voltage of the living area battery displayed on the panel LT 96.

**Danger of total discharge (battery alarm)**

Battery voltage (values during operation)	Mobile operation (vehicle moving, no 230 V connection)	Battery operation (vehicle stationary, no 230 V connection)	Power operation (vehicle stationary, 230 V connection)
11 V or less	12 V power supply overload	If appliances are switched off: Battery flat If appliances are switched on: Battery overload	12 V power supply overload
	The battery is not charged by the alternator, the alternator's regulator is defective		The battery is not charged by the transformer/rectifier, the transformer/rectifier is defective
11.5 V to 13.0 V	12 V power supply overload <sup>1)</sup>	Normal range	12 V power supply overload <sup>1)</sup>
	The battery is not charged by the alternator, the alternator's regulator is defective <sup>1)</sup>		The battery is not charged by the transformer/rectifier, the transformer/rectifier is defective
Over 13.5 V	Battery being charged	Occurs only briefly after charging	Battery being charged

<sup>1)</sup> If the voltage does not exceed this range for several hours.

Values for off-load voltage	Charging condition of the battery
Less than 12 V	Discharged or totally discharged
12.2 V	25 %
12.5 V	50 %
More than 12.7 V	100 %



▷ Total discharge causes irreparable damage to the battery.



- ▷ Measure the off-load voltage preferably several hours after the previous charging (e.g. in the morning) and not directly after a current drain.

#### Volume of water/ waste water

The V/tank gauge is for the indication of the quantity of water or waste water.

With the V/tank gauge (Fig. 191,8), note the right scale. The gauge automatically lights up as soon as a button is pressed.

- Displays:
- Press the button (Fig. 191,4): The volume of water is displayed.
  - Press the button (Fig. 191,7): The volume of waste water is displayed.



- ▷ Only read the tank levels briefly. Keeping the reading option on for a long time can damage the transducers.

### 9.7.3 Button for water pump

- Switching on:
- Press the button (Fig. 191,6): The water supply is ON. The water pump indicator lamp (Fig. 191,5) lights up.

- Switching off:
- Press the button (Fig. 191,6): The water supply is OFF. The water pump indicator lamp (Fig. 191,5) goes out.

#### Level indicator

No LED	2 LEDs	4 LEDs	6 LEDs	8 LEDs
0 %	25 %	50 %	75 %	100 %



- ▷ If the vehicle is not connected to the 230 V power supply and the water pump is not used for a longer period of time: Switch off the power supply for the water pump. The pump relay uses around 4 Ah current each day.

### 9.7.4 Battery alarm for the living area battery

The red "ALARM" warning light (Fig. 191,9) flashes as soon as the voltage of the living area battery falls below 11 V (measured under operation) and there is a risk of a total discharge.



- ▷ Total discharge damages the battery.

- Measures:
- When the battery alarm comes on, switch off the appliances and charge the living area battery, either by mobile operation or by connection to a 230 V power supply.

### 9.7.5 12 V indicator lamp

The 12 V indicator lamp (Fig. 191,1) lights up when the 12 V main button (Fig. 191,11) is switched on.



### 9.7.6 230 V indicator lamp

The 230 V indicator lamp (Fig. 191,3) illuminates whenever line voltage is available at the transformer/rectifier input.



- ▷ Further information can be obtained in the manufacturer's instruction manual.

## 9.8 Solar installation (optional equipment)



- ▷ Protect the solar collectors (solar module) against mechanical overload.



- ▷ The solar installation supplies the most current under optimal sunlight conditions.
- ▷ Provide the solar collectors (solar module) open access to sunlight.
- ▷ Sunlight is greater in the open air than under trees and bridges.
- ▷ Tarpaulins block out sunlight.
- ▷ Always keep collector surfaces free of contamination.
- ▷ Also read the manufacturer's instruction manual.

The solar installation provides an environmentally compatible power supply independent of the mains. It converts energy from sunlight into electric current. The solar installation supplies additional current for the battery and appliances.

The solar charge regulator has an integrated overload protection as well as deep discharge protection.

## 9.9 230 V power supply



- ▶ Only allow qualified personnel to work on the electrical system.
- ▶ Have the vehicle's electrical system checked by a qualified electrician at least once every 3 years. If the vehicle is used frequently, an annual check is recommended.

The 230 V power supply provides electricity for the following devices (if present):

- sockets with earth contact for appliances with maximum 10 A
- refrigerator
- transformer/rectifier
- an auxiliary charging unit
- air conditioning unit

The electrical appliances connected to the 12 V power supply of the living area are supplied with voltage by the living area battery.

Connect the vehicle to an external 230 V power supply system as often as possible. The charger module in the transformer/rectifier automatically charges the living area battery. In addition to this, the starter battery is charged with a float charge of 2 A.

Depending on the equipment, optional devices are fuse-protected by their own two-pole automatic circuit breaker.

### 9.9.1 230 V connection (CEE socket outlet)



- ▷ Overvoltage can damage connected devices. Overvoltage can be caused by lightning, irregular voltage sources (e.g. petrol-operated generators) or power connections on ferries for example.

#### Requirements concerning the 230 V connection

- The connecting cable, the plug connectors at the point of supply and the plug connector to the vehicle must comply with IEC 60309. The standard designation for the plug connectors is "CEE blue".
- Use H07RN-F rubber sheathed cable with a minimum cable cross-section of 2.5 mm<sup>2</sup> and a maximum length of 25 m.
- Earth contact connectors (safety) are not permitted. The interconnection of CEE/safety adapters is also prohibited.

### 9.9.2 Connecting the 230 V power supply



- ▶ The external 230 V power supply must be protected by fuse with a fault current protection switch (FI-switch, 30 mA).
- ▶ To prevent overheating, the cable must be fully uncoiled from the cable reel.
- ▶ In case of doubt or if the 230 V supply is not available or is faulty, contact the operator of the power supply device.



- ▷ The 230 V connection in the vehicle is equipped with a combined fault current protection switch with safety cut-out.
- ▷ Depending on the equipment, an additional safety cut-out is installed in the fuse box.
- ▷ For the connection points on camp sites (camping distributors) fault current protection switches (FI-switches, 30 mA) are obligatory.

The vehicle can be connected to an external 230 V power supply.

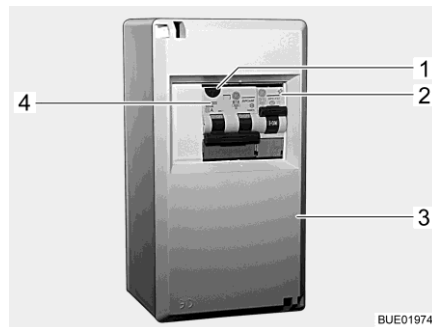

Fig. 192 230 V fuse box

- 1 Test button
- 2 Safety cut-out
- 3 Fuse box
- 4 Combined fault current protection switch / safety cut-out

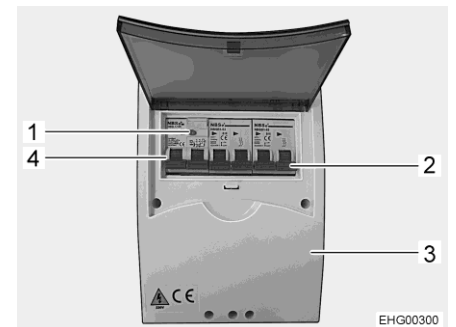

Fig. 193 230 V fuse box (variant)

- 1 Test button
- 2 Safety cut-out
- 3 Fuse box
- 4 Combined fault current protection switch / safety cut-out

#### Connecting the vehicle:

- Check whether the power supply device is suitable regarding connection, voltage, frequency and current.
- Check whether the cables and connections are suitable.
- Check the plug connectors and cables for visible damage.
- Switch off the safety cut-outs (Fig. 192,2, Fig. 192,4 or Fig. 193,2, Fig. 193,4) in the fuse box (Fig. 192,3 or Fig. 193,3).

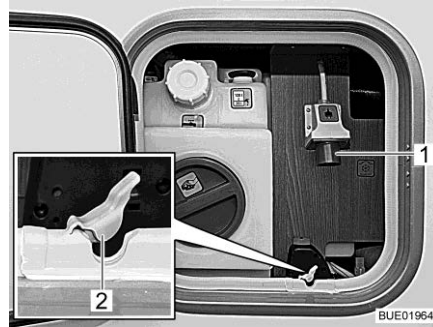

Fig. 194 230 V connection on the vehicle (with service unit)



Fig. 195 230 V connection on the vehicle (without service unit)

- Plug connector in service unit: Open the service flap.
  - Open the seal (Fig. 194,2) of the cable feedthrough.
  - Guide the cable through the cable feedthrough into the vehicle.
  - Plug the plug connector into the 230 V connection (Fig. 194,1) of the vehicle.
  - Close the service flap.
  - Plug connector outside the vehicle: Open the cover of the 230 V connection on the vehicle (Fig. 195) and insert the plug connector. Ensure that the detent of the spring-mounted pivoting cover is engaged in position.
  - Plug the connector of the connecting cable into the socket of the power supply device. Ensure that the detent of the spring-mounted pivoting cover is engaged in position.
  - Switch on the safety cut-outs in the fuse box.
- Checking the fault current protection switch:**
- When the vehicle is connected to the 230 V supply, press the test button (Fig. 192,1 or Fig. 193,1) of the combined fault current protection switch /safety cut-out (Fig. 192,4 or Fig. 193,4) in the fuse box (Fig. 192,3 or Fig. 193,3). The fault current protection switch must trip.
  - Switch the fault current protection switch back on again.
- Unplugging the connection:**
- Switch off the safety cut-outs (Fig. 192,2, Fig. 192,4 or Fig. 193,2, Fig. 193,4) in the fuse box (Fig. 192,3 or Fig. 193,3).
  - Loosen the detent on the power supply device and unplug the connection cable from the socket.
  - Plug connector in service unit: Open the service flap.
  - Unplug the plug connector from the connection (Fig. 194,1) of the vehicle and remove the connecting cable.
  - Press the seal (Fig. 194,2) of the cable feedthrough into the recess of the service flap gasket.
  - Close the service flap.
  - Plug connector outside the vehicle: Release detent, unplug plug connector, and close cover of the 230 V connection.

## 9.10 Fuses



- ▶ Only replace defective fuses when the cause of the defect is known and has been remedied.
- ▶ Replace defective fuses only after the power supply has been turned off.
- ▶ Do not replace screwed fuses yourself. Contact an authorised specialist workshop to have these replaced.
- ▶ Never bridge or repair fuses.
- ▶ Only replace faulty fuses with a new fuse with the same rating.

### 9.10.1 12 V fuses

The appliances connected to the 12 V power supply in the living area are fused individually. The fuses are accessible at different positions in the vehicle.

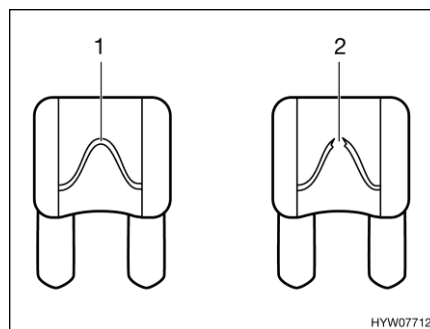

- 1 Unbroken fuse element
- 2 Broken fuse element

Fig. 196 12 V fuse

An intact 12 V fuse can be detected by the unbroken fuse element (Fig. 196,1). If the fuse element is broken (Fig. 196,2), change the fuse.

Before changing fuses, take the function, value and colour of the relevant fuses from the following specifications. When changing fuses, only use flat fuses with the values shown below.

### Fuses on the starter battery (Fiat)

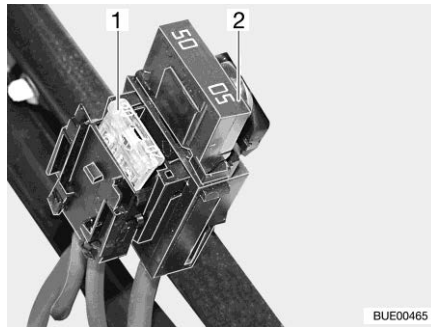

- 1 Flat fuse 20 A/yellow
- 2 Jumbo flat fuse 50 A/red

Fig. 197 Fuses on the starter battery

Position	Function	Value/colour
In the floor compartment between the driver's cabin seats	Float charge EBL	20 A/yellow
	Starter battery	50 A/red

### Fuses on the starter battery (Ford)

Position	Function	Value/colour
In the floor compartment beneath the front passenger's seat	Float charge EBL	20 A/yellow
	Starter battery	50 A/red
	Relay 12 V D+	2 A/grey

### Fuses on the living area battery

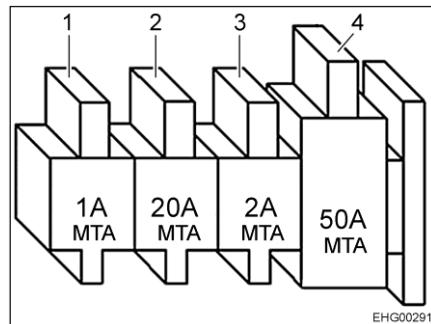

- 1 Flat fuse 1 A/ black
- 2 Flat fuse 20 A/yellow
- 3 Flat fuse 2 A/grey
- 4 Jumbo flat fuse 50 A/red

Fig. 198 Fuses on the living area battery (with charging booster)

Position	Function	Value/colour
On the living area battery	Charging booster voltage sensor	1 A/black
	Refrigerator	20 A/yellow
	Transformer/rectifier voltage sensor	2 A/grey
	Transformer/rectifier	50 A/red

**Fuses on the relay box  
AD01**

A relay box (AD01) is installed in one of the two seat consoles. The relay box helps generate the signals for the chassis lighting not provided by the base vehicle. The relay box can be used anywhere.

The circuit used by us can vary from the circuit provided by the manufacturer. Consequently, the circuit can also vary from the display on the relay box type plate, which the manufacturer affixed.

Fu No	Function	Value/colour
B2	Cl. 15 (ignition on)	15 A/blue
B3	Cl. 30 (constant positive)	15 A/blue
B5	Signal D+	Internal Polyswitch (2 A)
B6	Spare	15 A/blue
B7	Front side marker lights (white/red)	5 A light brown

**Fuses on the  
transformer/rectifier**

Function	Value/colour
Internal charger module	20 A yellow
Compressor/AES refrigerator	20 A yellow
Heater	10 A red
Basic light/electrically operated entrance step/radio	25 A white
Spare 4	25 A white
Spare 3	25 A white
Spare 2	15 A blue
Spare 1	15 A blue
Solar	15 A blue
Spare 5	15 A blue
Spare 6	15 A blue
Auxiliary charging unit	20 A yellow
Circuit 1	10 A red
Circuit 2	10 A red
TV	10 A red
Water pump	5 A light brown

**Fuse for the Thetford toilet  
(swivel toilet)**

The fuse is located in the locker wall of the Thetford cassette.

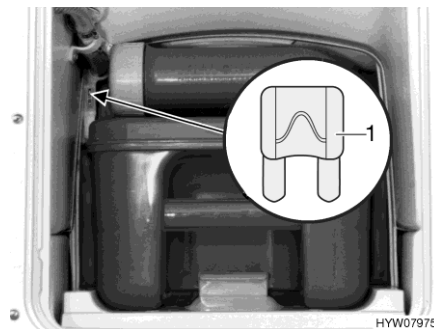

1 Flat fuse 3 A/purple

Fig. 199 Fuse for the Thetford toilet

- Changing:
- Open the flap for the Thetford cassette on the outside of the vehicle.
  - Pull out the Thetford cassette completely.
  - Replace fuse (Fig. 199,1).

**Fuse for the Thetford toilet  
(fixed seat)**

The fuse is located in the locker wall of the Thetford cassette.

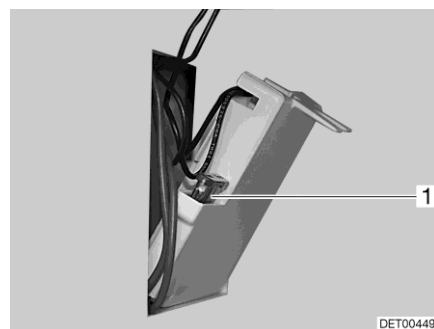

1 Flat fuse 3 A/purple

Fig. 200 Fuse for the Thetford toilet

- Changing:
- Open the flap for the Thetford cassette on the outside of the vehicle.
  - Remove the Thetford cassette and swing out the flap in the housing panel.
  - Replace fuse (Fig. 200,1).

**Fuse for waste water  
heating**

The control unit has an electronic overload protection. In the event of an overload, the waste water heating switches off. To restart, disconnect the control unit briefly from the power supply.

Depending on the model, the supply voltage of the waste water heating will be protected by the fuse circuit Spare 3 or Spare 4.

**Overview of electrical  
pull-down bed fuses**

Model	Control fuse	Power fuse
Limited T	2 A at pull-down bed motor	25 A Spare 3 on transformer/rectifier
Lyseo TD front bed	2 A at pull-down bed motor	25 A Spare 3 on transformer/rectifier
Lyseo TD rear bed	2 A at pull-down bed motor	25 A Spare 3 on transformer/rectifier





- ▷ If the vehicle is equipped with a pull-down bed in the front and a pull-down bed in the rear: Do not move both pull-down beds at the same time.

**Fuse for the pull-down bed**

The fuse (2 A/grey) for the front pull-down bed is installed behind panelling (Fig. 201,1) in the front left wall-mounted cupboard.

In addition, the pull-down bed also has a fuse on the transformer/rectifier at the Spare 3 connection for protection.

The fuse (2 A/grey) for the pull-down bed in the rear (if present) is installed behind panelling (Fig. 201,1) in the rear left wall-mounted cupboard (Lyseo TD 744).

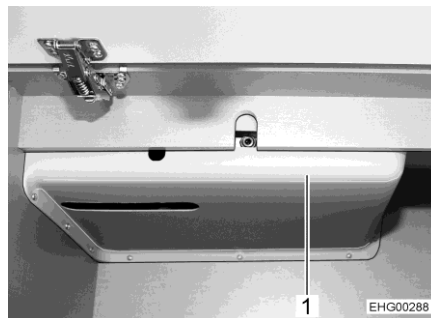

Fig. 201 Panelling in the wall-mounted cupboard

**9.10.2 230 V fuse**



- ▷ Check the fault current protection switch for each connection to the 230 V power supply, at least once every 6 months.



- ▷ In international language usage, the fault current protection switch is also denominated RCD (Residual Current Device).

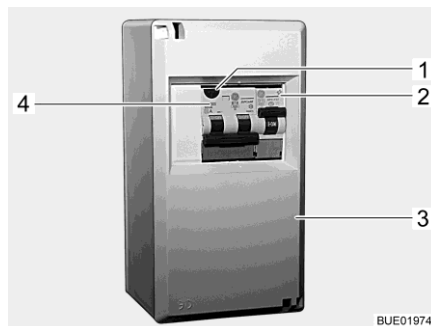

Fig. 202 230 V fuse box

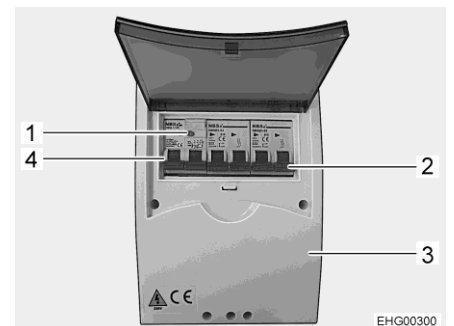

Fig. 203 230 V fuse box (variant)

A combined fault current protection switch / safety cut-out (Fig. 202,4 or Fig. 203,4) in the fuse box (Fig. 202,3 or Fig. 203,3) protects the complete vehicle from fault current (0.03 A).

The integrated safety cut-out (16 A) protects the 230 V sockets, the power supply unit, the auxiliary charging unit, and the refrigerator.

For vehicles with special equipment (e.g. air conditioning unit) an additional safety cut-out (10 A) (Fig. 202,2 or Fig. 203,2) secures the device.

Checking the fault current protection switch:

- When the vehicle is connected to the 230 V power supply, press the test button (Fig. 202,1 or Fig. 203,1). The fault current protection switch must trip.

**Position** See chapter 17.

### 9.11 External socket (optional equipment)

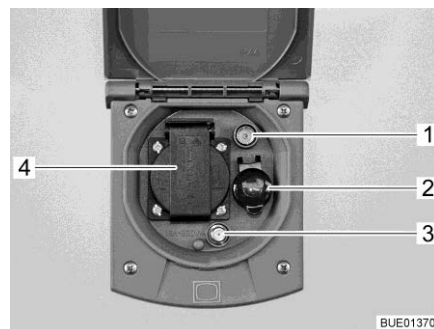

Fig. 204 External socket

The 230 V socket and the 12 V socket can be used to power electrical devices in the awning.

**Connection possibilities**

TV socket and SAT socket offer various possibilities for TV operation:

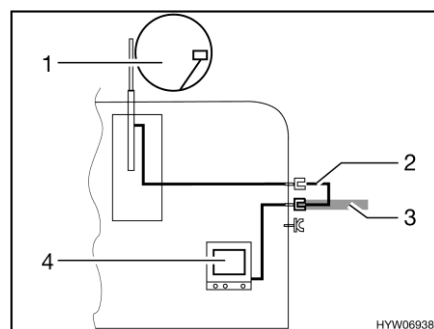

Fig. 205 TV inside the vehicle

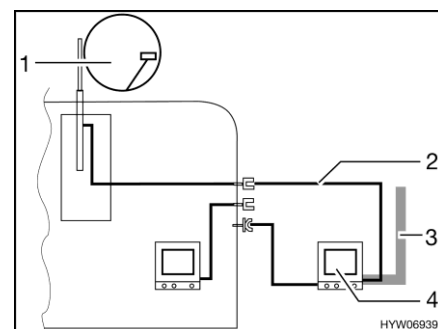

Fig. 206 TV in the awning

- TV inside the vehicle (Fig. 205,4): Connection to roof antenna (Fig. 205,1) with connection cable (Fig. 205,2)
- TV inside the vehicle (Fig. 205,4): Connection to external antenna (Fig. 205,3)
- TV inside the awning (Fig. 206,4): Connection to roof antenna (Fig. 206,1) with connection cable (Fig. 206,2)
- TV inside the awning (Fig. 206,4): Connection to external antenna (Fig. 206,3)

9.12 Circuit diagrams

9.12.1 Circuit diagram, interior (EBL 119/EBL 99)

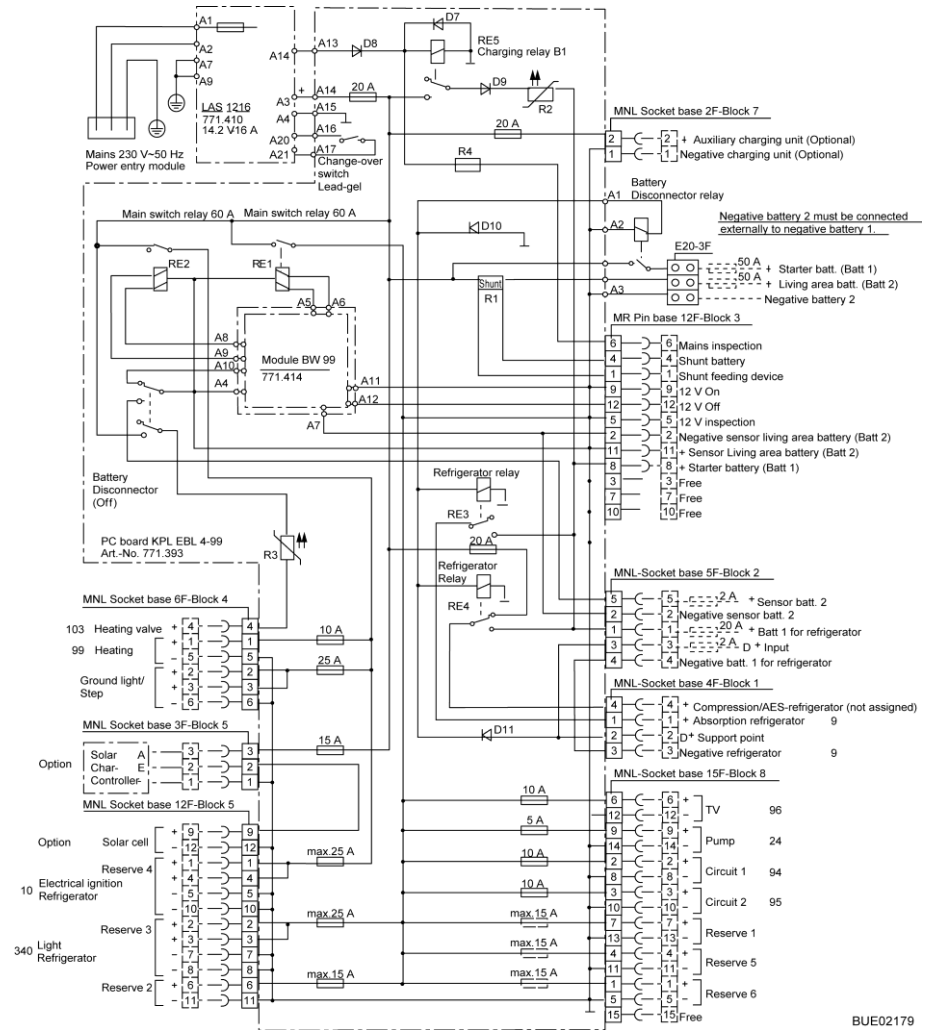

Fig. 207 Circuit diagram, interior (EBL 119/EBL 99)

## 9.12.2 Connection diagram, panel (LT 96)

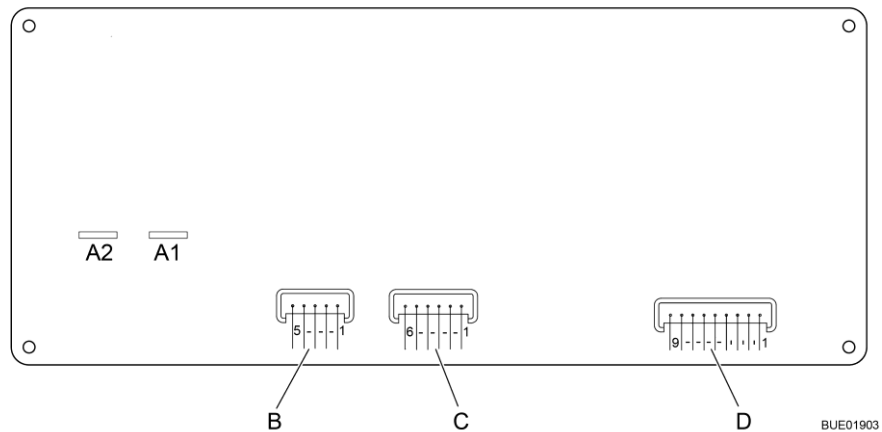

Fig. 208 Connection diagram, panel (LT 96)

<b>A</b>	<b>2 x AMP connectors 4,8 x 0,8</b>
1	Pump
2	+ 12 V
<b>B</b>	<b>Lumberg MSFQ 5-pin</b>
1	full
2	3/4
3	1/2
4	1/4
5	Base waste water tank
<b>C</b>	<b>Lumberg MSFQ 6-pin</b>
1	full
2	3/4
3	1/2
4	1/4
5	Base water tank
6	n. c.
<b>D</b>	<b>Lumberg MSFQ 9-pin</b>
1	12 V indicator
2	Main button 12 V Off
3	Main button 12 V On
4	Positive Starter battery 12 V
5	Positive Living area battery sensor
6	Negative Living area battery sensor
7	230 V indicator
8	n. c.
9	n. c.

## 9.12.3 Circuit diagram, exterior

X1 Central connector  
(MCP 12-pole)

Pin	Colour of conductor	Signal
1	wh	GND
2	gy	Tail light, left
3	bn	Tail light, right
4	ye	Direction indicator lamp, left
5	gn	Direction indicator lamp, right
6	rd	Brake light, left
7	or	Brake light, right
8	rd	Third brake light
9	bu	Fog tail light, left
10	vt	Right fog tail lights
11	pi	Licence plate light
12	vt	Reverse light, left
13	vt	Reverse light, right

Connector for  
tail light, left  
(Superseal 6-pole)

Pin	Colour of conductors of wiring harness	Colour of conductors of tail light	Signal
1	wh	wh	GND
2	vt	gy	Reverse light
3	bu	bu	Fog tail light
4	ye	ye	Direction indicator light
5	rd	rd	Brake light
6	gy	bk	Tail light

Connector for  
tail light, right  
(Superseal 6-pole)

Pin	Colour of conductors of wiring harness	Colour of conductors of tail light	Signal
1	wh	wh	GND
2	vt	gy	Reverse light
3	vt	bu	Fog tail light
4	gn	ye	Direction indicator light
5	or	rd	Brake light
6	bn	bk	Tail light

X4 Connector for  
third brake light  
(MNL 2-pole)

Pin	Colour of conductor	Signal
1	rd	Third brake light
2	wh	GND

X5/X6 Licence  
plate light  
(spade connector)

Pin	Colour of conductor	Signal
1	pi	Licence plate light
2	wh	GND



## Chapter overview

This chapter contains instructions regarding the appliances of the vehicle.

The instructions refer exclusively to the operation of the appliances.

Further information about the appliances can be found in the instruction manuals for the appliances, included separately with the vehicle.

### 10.1 General



- ▷ For safety reasons, spare parts for pieces of heating appliances must correspond with manufacturer's instructions and be permitted by the manufacturer as a spare part. These spare parts may only be fitted by the manufacturer or an authorised specialist workshop.



- ▷ Further information can be obtained in the instruction manual for the respective appliance.

The heater, boiler, cooker and refrigerator are fitted depending on the model of the vehicle.

In this instruction manual a description is given only for the operation of the appliances and their particular features.

To operate gas appliances, first open the regulator tap on the gas bottle and the gas isolator tap corresponding to the appliance.

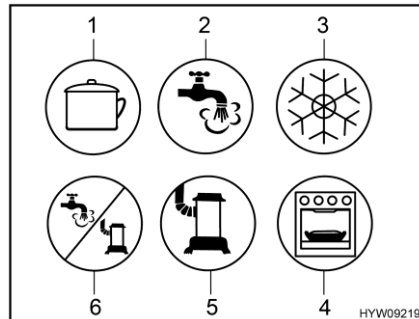

- 1 Cooker
- 2 Hot water
- 3 Refrigerator
- 4 Oven/grill
- 5 Heater
- 6 Hot water/heater

Fig. 209 Possible symbols for the gas isolator taps

## 10.2 Heater and boiler

The heater can both heat up the vehicle interior (heating the room air) and heat up the domestic water (boiler function). The following instructions are also valid if the heater is only used as boiler.



- ▶ Never let gas escape unburned due to danger of explosion.
- ▶ Never run the heater in gas operation when refuelling, on ferries or in the garage. Danger of explosion!
- ▶ Never operate the heater in gas operation in closed spaces (e.g. garages). Danger of poisoning and suffocation!
- ▶ The waste gas vent may neither be closed nor blocked.
- ▶ Do not use the space behind the heater as a storage space.
- ▶ The water in the boiler can be heated up to 65 °C. Risk of scalding!



- ▷ Never use boiler when empty.
- ▷ If the boiler is not being used, empty it if there is any risk of frost.
- ▷ Only operate the boiler with the maximum temperature setting if you require a large quantity of warm water. This protects the boiler against the build-up of limescale.
- ▷ In winter operation (heater and hot water), the circulation fan is automatically switched on when the hot-air heater is activated, and it stays on. This drains the living area battery when the vehicle is not connected to an external 230 V power supply. Take into consideration that the living area battery only has limited reserves of energy.



- ▷ Do not use the water from the boiler as drinking water.
- ▷ The hot-air heater can even run on an empty boiler.
- ▷ When the heater has been switched on, the waste water tank and waste water pipes are automatically heated as well.
- ▷ If the power supply to the heater was interrupted, the time must be reset.

### Initial start-up

When lighting the heater for the first time a small amount of smoke and odour will occur. Immediately set the operating switch of the heater to its highest position. Open doors and windows and ventilate well. Smoke and odour will disappear by themselves after a while.



### 10.2.1 To heat properly



- ▷ Hot air may damage the floor covering. Do not point the air outlet nozzles towards the floor covering.



Fig. 210 Air outlet nozzle (hot-air heater)

#### Hot air distribution

Several air outlet nozzles (Fig. 210) are built into the vehicle. Pipes conduct the warm air to the air outlet nozzles. Turn the air outlet nozzles in a suitable position so the air can escape as required. To avoid draft close the air outlet nozzles on the dashboard and set the air distribution of the base vehicle to air circulation.

#### Adjusting the air outlet nozzles

- Fully open: Full hot air stream
- Half or partially open: Reduced hot air stream

When five air outlet nozzles are completely opened, less warm air escapes through each nozzle. However, if only three air outlet nozzles are opened, more warm air flows out of each nozzle.

### 10.2.2 Hot-air heater and boiler with CP plus digital operating unit



- ▷ If there is a risk of frost and the heater is not in operation, empty the boiler.
- ▷ In winter operation (heater and hot water), the circulation fan is automatically switched on when the hot-air heater is activated, and it stays on. This puts an immense strain on the living area battery, if the vehicle is not connected to an external 230 V power supply. Take into consideration that the living area battery only has limited reserves of energy.



- ▷ Depending on the equipment, the heater can be operated from a mobile terminal (e.g. smartphone, tablet PC) via an app. The Truma app can be loaded for common mobile terminals via the respective app stores.
- ▷ The hot-air heater can even run on an empty boiler.
- ▷ If the power supply to the heater was interrupted, the time must be reset.

**Maximum heat output**

Gas operation	Electrical operation	Mixed operation (gas and electrical operation)
6000 W	1800 W	5800 W

**Operating unit**

The operating unit is divided into two sections:

- Display
- Operating buttons



- 1 Display
- 2 Rotary push button
- 3 Back button

Fig. 211 Operating unit (hot-air heater and boiler)

After being switched on, the most recently set values/operating parameters are activated.

If no button is pressed, the operating unit switches to stand-by mode after a few minutes.

If the time is set, the display in stand-by mode alternates between the time and the room temperature set.

After being switched off, the display in the control unit may remain active for several minutes since the heater is still running.

**Operating buttons**

The operating buttons have the following functions:

Button	Button operation	Function
Rotary push button (Fig. 211,2)	Turn to the right	Menu is run through from left to right Values are increased
	Turn to the left	Menu is run through from right to left Values are decreased
	Press briefly	Selected value is saved Menu item is selected for changing values (selected menu item flashes)
	Press (3 seconds)	Switch on or switch off
Back button (Fig. 211,3)	Press	Return from a menu item without saving values

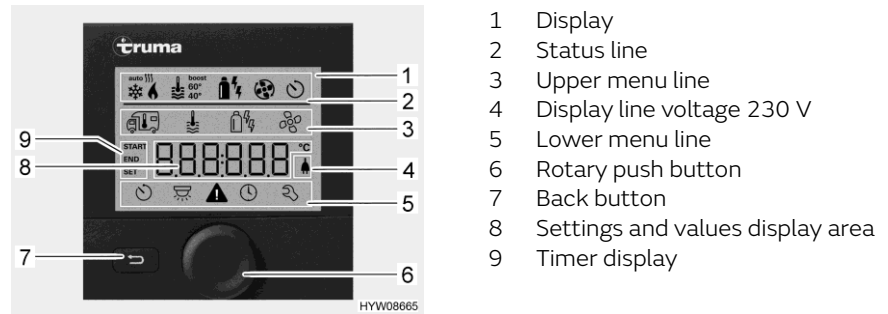

Fig. 212 Operating unit with displays

**Display**

The display is divided into four sections:

- Status line (Fig. 212,2)
- Upper menu line (Fig. 212,3)
- Display area (Fig. 212,8)
- Lower menu line (Fig. 212,5)

**Switching the operating unit on/off:**

- Press and hold the rotary push button (Fig. 212,6) for approx. 3 seconds. Both menu lines (Fig. 212,3 and Fig. 212,5) are displayed. The first symbol flashes.



- ▷ Switching the operating unit on/off means switching between stand-by and setting mode. In stand-by mode, the display alternates between the room temperature and the time that have been set.

**Carrying out settings:**

- Turn the rotary push button (Fig. 212,6) until the required menu symbol flashes.
- Press the rotary push button.
- Turn the rotary push button until the required value is displayed.
- Press the rotary push button to save the value set. If you do not wish to change the value originally set: Press the back button (Fig. 212,7).

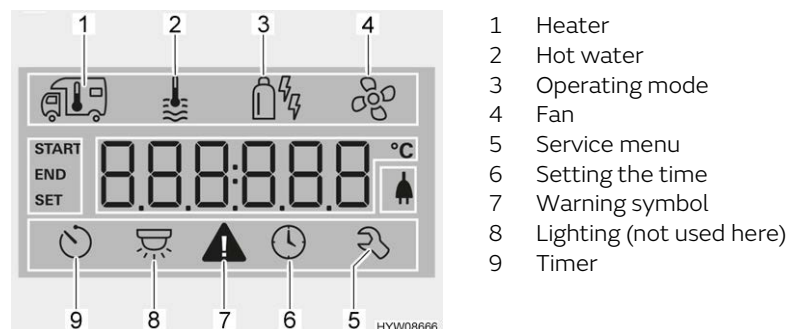

Fig. 213 Display (operating unit)

**Switching on the heater:**

- Open the regulator tap on the gas bottle and the gas isolator tap "Heater/boiler".
- Turn the rotary push button (Fig. 212,6) until the heater menu symbol (Fig. 213,1) flashes.
- Press the rotary push button.
- Turn the rotary push button until required value is displayed.

- Press the rotary push button to save the value set. The symbol in the status line (Fig. 212,2) flashes until the room temperature set is reached. If you do not wish to change the value originally set: Press the back button (Fig. 212,7).

#### Switching off the heater:

- Turn the temperature value back until OFF is displayed. Press the rotary push button to save.



- ▷ The required room temperature can also be changed in stand-by mode by turning the rotary push button.

#### Switching on production of hot water:

- Open the regulator tap on the gas bottle and the gas isolator tap "Heater/boiler".
- Turn the rotary push button (Fig. 212,6) until the hot water menu symbol (Fig. 213,2) flashes.
- Press the rotary push button.
- Turn the rotary push button until the required value is displayed:
  - OFF: Production of hot water is switched off.
  - 40°: Hot water is heated to 40 °C.
  - 60°: Hot water is heated to 60 °C.
  - BOOST: Fast heating of hot water (boiler priority) for max. 40 minutes. The water temperature is then held at a higher level for two reheating cycles (approximately 62 °C).
- Press the rotary push button to save the value set. The symbol in the status line (Fig. 212,2) flashes until the hot water temperature set is reached. If you do not wish to change the value originally set: Press the back button (Fig. 212,7).

#### Switching off production of hot water:

- Turn the rotary push button until OFF is displayed. Press the rotary push button to save.

#### Safety/drainage valve

The boiler is equipped with a safety/drainage valve (Fig. 214). The safety/drainage valve prevents water in the boiler from freezing, when there is frost and the heater is not switched on.



- ▷ When the vehicle is not used for a long period of time, open the safety/drainage valve and empty the boiler.
- ▷ At temperatures below 2 °C the safety/drainage valve opens automatically. Only if the temperature of the safety/drainage valve lies above 6 °C can it be shut again.
- ▷ The water pump and the water fittings are not protected against freezing by the safety-/drainage valve.



- ▷ The drainage neck of the safety/drainage valve has to be free of dirt (e.g. leaves, ice) at all times.

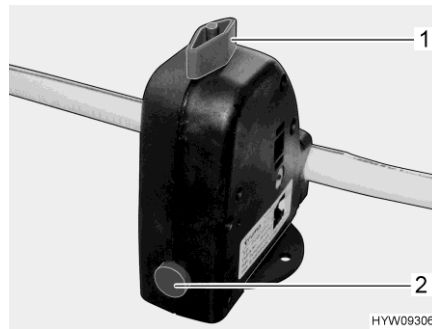

Fig. 214 Safety/drainage valve (boiler)

**Position** See chapter 17.

**Filling/emptying the boiler** The boiler can be supplied with water from the water tank.

**Filling the boiler with water:**

- Switch on the 12 V power supply on the panel.
- Close the safety/drainage valve. Turn the knob (Fig. 214,1) perpendicular to the safety/drainage valve and push the push button (Fig. 214,2) in.
- Set all the water taps to "Hot" and open them. The water pump is turned on. The warm water pipes are filled with water.
- Keep the water taps open until the water flowing out of the water taps has no bubbles in it. This is the only way to ensure that the boiler is full of water.
- Close all water taps.

**Emptying the boiler:**

- Switch off hot water production.
- Open the safety/drainage valve. To do this turn the knob (Fig. 214,1) parallel to the safety/drainage valve. The push button (Fig. 214,2) jumps out. The boiler is drained to the outside by the safety/drainage valve.
- Check whether the water has been drained completely from the boiler (approx. 10 litres).



- ▷ For further information about emptying the water system see section 11.2.7.
- ▷ For further information about the boiler see the separate manufacturer's instruction manual and observe the maintenance instructions in chapter 13.





**Operating modes**

The hot-water heater with the boiler can be operated with various energy sources.

**Selecting operating mode:**

- Turn the rotary push button (Fig. 212,6) until the menu symbol operating mode (Fig. 213,3) flashes.
- Press the rotary push button.

- Turn the rotary push button until the desired operating mode is displayed:

-  Gas operation
-  Electrical operation (900 W)
-  Electrical operation (1800 W)
-  Gas and electrical operation (900 W)
-  Gas and electrical operation (1800 W)

- Press the rotary push button to save the set operating mode. To revert to the original setting: Press the back button (Fig. 212,7).



- ▷ 230 V electrical operation is only possible when the vehicle is connected to the 230 V power supply.
- ▷ Select the output level for 230 V electrical operation so that it corresponds to the fuse protection of the 230 V connection (900 W for 3.9 A fuse, 1800 W for 7.8 A fuse).

The combination of gas operation and 230 V electrical operation shortens the time required to heat up the vehicle.

#### Setting the fan:

- Turn the rotary push button (Fig. 212,6) until the fan menu symbol (Fig. 213,4) flashes.
- Press the rotary push button.
- Turn the rotary push button until the required value is displayed:
  - OFF: Fan is switched off.
  - VENT: Air circulation
  - ECO: Low fan setting
  - HIGH: High fan setting
  - BOOST: Fast room heating. Boost is available if the current room temperature is at least 10 °C below the selected room temperature.
- Press the rotary push button to save the value set. If you do not wish to change the value originally set: Press the back button (Fig. 212,7).

#### Setting the timer:

- Turn the rotary push button (Fig. 212,6) until the timer menu symbol (Fig. 213,9) flashes.
- Press the rotary push button. The start time is displayed and the hour display flashes.
- Turn the rotary push button until the hour of the selected start time is displayed.
- Press the rotary push button. The minute display flashes.
- Turn the rotary push button until the minute of the selected start time is displayed.
- Press the rotary push button.
- Proceed in the same way to set the switch-off time, the required room temperature, the hot water setting and the fan setting.
- Press the rotary push button. The timer is activated. The timer symbol (Fig. 213,9) flashes when the timer is programmed and active.



- ▷ The service menu contains items that generally only need to be set once (language, background brightness, calibration), as well as information for service centres (version numbers).

#### Fault display

The warning symbol (Fig. 213,7) flashes in the event of a warning. The heater continues to operate. In the event of only a temporary fault, the warning symbol goes out automatically.

In the event of a warning, the control unit displays the error code for the fault. The heater is switched off. Press the rotary push button to restart the heater.



- ▷ Further information can be obtained in the manufacturer's instruction manual.

### 10.2.3 Alde hot-water heater and boiler Alde Compact 3030 (optional equipment)



- ▶ For safe handling of the Alde system, follow the manufacturer's separate instruction manual.
- ▶ Observe safety instructions for handling gas, see section 8.1.
- ▶ Danger of scalding from hot water. Do not set the water temperature above 48 °C. Check water temperature before use.
- ▶ Do not make any changes to the heating system or the control system.



- ▷ Never run hot-water heater without heating fluid. Observe the notes in chapter 13.
- ▷ Never drill holes in the floor. This might damage the hot-water pipes.
- ▷ Ensure that there is enough water in the water tank to supply the heating system.



- ▷ The circulating pump must always be turned on when the hot-water heater is in operation.
- ▷ We recommend to bleed the heating system after the initial heater operation and to check the glycol content. Observe the notes in chapter 13.

The heating system consists of a gas- and electricity-fired boiler and convectors. The system supplies heat to the convectors by circulating a heating fluid (glycol mixture). The heating fluid is heated by gas and/or electricity. A boiler with a volume of approx. 8.5 l is also built into the heating system. Heating and boiler are controlled via a control panel and supplied with water from the water tank.

**Position** See chapter 17.

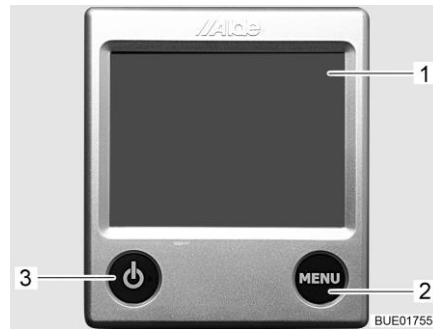

- 1 Display
- 2 "MENU" button
- 3 "On/Off" button

Fig. 215 Control unit

#### Switching on the heating system:

- Press the "On/Off" button (Fig. 215,3) on the control unit. A green LED lights up on the "On/Off" button. The system starts with the last selected settings.
- To change settings: Press the "MENU" button (Fig. 215,2) and select the desired function.



- ▷ For further operation, refer to the manufacturer's separate instruction manual.

#### Switching off the heating system:

- Press the "On/Off" button (Fig. 215,3) on the control unit. The green LED goes out.



- ▷ When no button is pressed, the control unit automatically switches to home position after two minutes.
- ▷ Changes to the settings are saved automatically after 10 seconds.

#### Setting the rotational speed of the circulating pump



- ▷ The hot-water heater is equipped with a very powerful pump. In smaller vehicles, the pump can only be operated at full power if the system is emptied or the pipes are bled. Otherwise, this will increase wear; loud operating noises are the result.



Fig. 216 Speed reduction

The rotational speed of the circulating pump can be set with the control knob (Fig. 216,2). At a lower rotary speed, the operating sounds of the pump are quieter.

The control knob is located on the circulating pump (Fig. 216,1).



- Setting the output:**
- Turn the control knob (Fig. 216,2) in an anticlockwise direction. The output is reduced.
  - Rotate the control knob in a clockwise direction. The output is increased.

**3-way valve**

For models with a rear bed, a 3-way valve is connected to the hot-water heater circulation. The 3-way valve is installed in the rear garage. The 3-way valve can be accessed via an external flap.



Fig. 217 3-way valve

- Opening the heat circulation in the rear area:**
- Set the lever (Fig. 217,2) of the 3-way valve (Fig. 217,1) parallel to the straight flow direction (Fig. 217).
- Locking the heat circulation in the rear area:**
- Set the lever (Fig. 217,2) of the 3-way valve (Fig. 217,1) transverse to the straight flow direction.

**Alde heat exchanger (optional equipment)**

- ▷ The heat exchanger only works when the vehicle engine is running.
- ▷ If the heat exchanger is not being used (as in the summer), the heat exchanger on the stopcock should be shut off.

The heat exchanger can be used to heat the living area of the vehicle during travel without operating the hot-water heater in the living area.

The heat exchanger is connected to the vehicle engine's cooling circuit and thus has the same function as the vehicle heater.

Heat output is set with the living area's heating regulator.

The heat exchanger stopcock is located directly on the exchanger.

**Turning on the vehicle heating by heat exchanger:**

- Make sure the heat exchanger stopcock is open.
- Press the "⏻" button (Fig. 215,3) on the control unit. The start screen appears in the display. That turns on the heating control system and makes the circulating pump run.
- Press "MENU" button (Fig. 215,2).
- Turn off gas operation or 230 V electrical operation (if turned on).
- Set the desired room temperature. To do that, press the "+" or "-" button next to the "🏠" symbol.

Turning off the vehicle heating by heat exchanger:

- Press the "⏻" button (Fig. 215,3) on the control unit.



Fig. 218 Alde heat exchanger

- Turning on: ■ Set stopcock handle (Fig. 218,1) parallel to the pipe.
- Turning off: ■ Set stopcock handle (Fig. 218,1) at a right angle to the pipe.

**Position** The heat exchanger is installed in the rear bench seat of the central seating group.

#### Alde auxiliary circulating pump (optional equipment)



- ▷ The auxiliary circulating pump works only if the heat exchanger has been installed and started, and the hot-water heater is running.

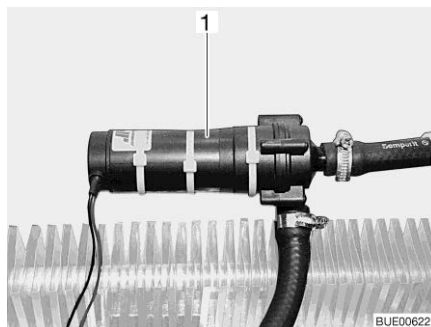

Fig. 219 Auxiliary circulating pump

The auxiliary circulating pump (Fig. 219,1) can be used to heat the vehicle engine when parked.

The auxiliary circulating pump is connected to the vehicle engine's cooling circuit and thus functions as an engine heater.



Fig. 220 Operating switch for auxiliary circulating pump

The auxiliary circulating pump switch (Fig. 220) is located next to the hot-water heater operating unit. The yellow indicator lamp illuminates when the pump is operated.

### Filling/emptying the boiler



The boiler can be supplied with water from the water tank.

- ▷ Depending on the model, the vehicle is fitted with one or two drain cocks.

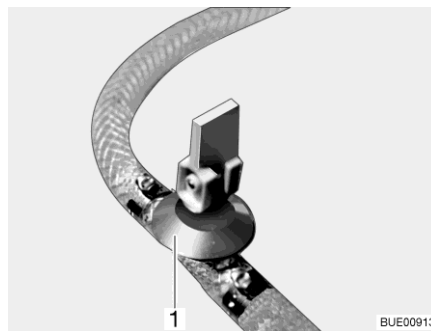

Fig. 221 Drain cock

#### Filling the boiler with water:

- Close the drain cock(s). Position the rocking lever (Fig. 221,1) horizontally.
- Switch on the 12 V power supply on the panel.
- Set all the water taps to "Hot" and open them. The water pump is turned on. The warm water pipes are filled with water.
- Keep the water taps open until the water flowing out of the water taps has no bubbles in it. This is the only way to ensure that the boiler is full of water.
- Close all water taps.

#### Emptying the boiler:

- Switch off the boiler.
- Open all water taps and set to the central position.
- Open drain cock(s) (Fig. 221). To do so, set the rocking lever (Fig. 221,1) in a vertical position. The boiler is drained to the outside.
- Check whether the water has been drained completely from the boiler (approx. 10 litres).



- ▷ For further information, see the separate manufacturer's instruction manual and observe the maintenance instructions found in chapter 13.

#### Position of the drain cock(s)

See chapter 17.

### 10.2.4 Wall flue

Fresh air and exhaust gases of the heater system are conducted in a two-chamber wall flue.



- ▷ Park the vehicle such that the wall flue gets enough fresh air.
- ▷ The wall flue must be free at all times. Do not cover the wall flue.
- ▷ When camping in winter, maintain wall flue free of snow and ice.
- ▷ Check the wall flue periodically depending on the weather (snow, leaf fall, dirt, etc.). If necessary, clean the wall flue.
- ▷ When washing the vehicle do not aim the water jet directly at the wall flue.
- ▷ When disregarding this, the flawless operation of the heater can not be guaranteed.



Fig. 222 Wall flue (hot-water heater)



Fig. 223 Wall flue (hot-air heater)

The wall flue is mounted on the left side wall.

### 10.2.5 Electrical floor warming unit (optional equipment)



- ▶ On models with electrical floor warming unit, never drill holes in the floor or screw in any screws. Careful with sharp objects. There is danger of a power cut or a short circuit due to damage to a heater wire.



- ▷ Do not cover the transformer. Danger of overheating!



- ▷ The electrical floor warming unit only operates if the vehicle is connected to the 230 V power supply.
- ▷ The output of the electrical floor warming unit alone is not sufficient to heat the living area.



Fig. 224 Transformer for electrical floor warming unit

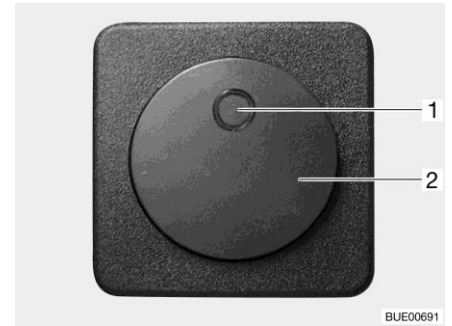

Fig. 225 Switch for electrical floor warming unit

The transformer for the electrical floor warming unit is installed either in the bench seat or in the bedding box, depending on the model.

- Switching on:**
- Connect the vehicle to the 230 V power supply (see chapter 9).
  - Press the rocker switch (Fig. 225,2). The indicator lamp (Fig. 225,1) on the switch is illuminated.

- Switching off:**
- Press the rocker switch (Fig. 225,2). The indicator lamp (Fig. 225,1) on the switch goes off.

After switching off, the floor remains warm for a while, due to residual heat. If the transformer (Fig. 224,1) is overloaded, the overload protection is actuated. The pin (Fig. 224,2) jumps out.

- Switching on overload protection:**
- Press the pin (Fig. 224,2) on the overload protection when the transformer is cooled.

### 10.3 Telair air conditioning unit (optional equipment)



- ▷ Always wait at least 2 minutes between switching off and switching on again. Otherwise the compressor will be damaged.
- ▷ If the unit is operating, always open at least one ventilation flap.



- ▷ The air conditioning unit only runs if the vehicle is connected to a 230 V power supply.
- ▷ In the winter, vehicle heating can be supported but not replaced by the air conditioning unit.
- ▷ Following switch-on the air conditioning unit needs approx. 3 minutes until the compressor starts to run and cold air or hot air is output.
- ▷ Also read the manufacturer's instruction manual.

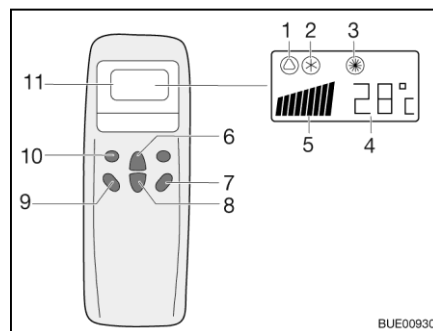

- 1 Symbol for automatic
- 2 Symbol for cooling
- 3 Symbol for heater
- 4 Temperature (set) display
- 5 Fan speed display
- 6 Temperature increase button
- 7 "ON/OFF" button
- 8 Temperature reduction button
- 9 Ventilation speed button
- 10 "Mode" button
- 11 Display

Fig. 226 Remote control

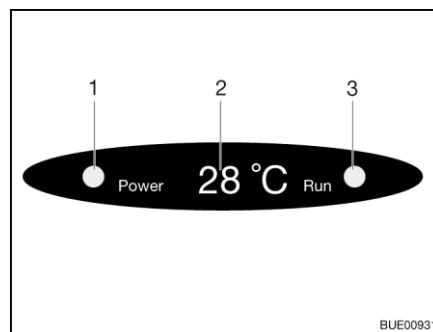

- 1 Mains connection indicator lamp
- 2 Temperature (current) display
- 3 Operating mode indicator lamp  
Green: Cooling  
Red: Heater

Fig. 227 Display on the diffuser

To execute the individual switching commands, always point the remote control in the direction of the receiver.

#### Operating modes

- Automatic
- Cooling
- Heater

#### Switching on:

- Press the "ON/OFF" button (Fig. 226,7).
- Press the "Mode" button (Fig. 226,10) as often as required until the required operating mode (Fig. 226,1, 2 or 3) is indicated on the display. The corresponding indicator lamp on the diffuser display (Fig. 227,3) lights up.
- Use the temperature increase button (Fig. 226,6) or temperature reduction button (Fig. 226,8) to set the required temperature.

Switching off:



- Use the ventilation speed button (Fig. 226,9) to select the required ventilation level.
- Press the "ON/OFF" button (Fig. 226,7).
- ▷ If the air conditioning unit has run in heating mode, the blower will run on for some minutes in order to dissipate the heat completely.

## 10.4 Cooker



- ▶ During operation of the gas cooker, do not leave the gas cooker unattended. Even if the gas cooker cannot be overseen for only a short time (e.g. Visit to the toilet), switch the gas cooker off.
- ▶ Never let gas escape unburned due to danger of explosion.
- ▶ Before using the cooker make sure that there is sufficient ventilation. Open a window or the skylight.
- ▶ Do not use gas-operated cooking and baking facilities for heating purposes.
- ▶ Always protect your hands with cooking gloves or potholders when handling hot pots, pans and similar items. There is a risk of injury!
- ▶ Do not fit any curtains in the immediate proximity of the cooker. Fire hazard!



- ▷ Do not place any hot objects such as cooking pans neither on the sink cover nor on the gas cooker cover nor on the work top.

### 10.4.1 Gas cooker



- ▶ If using gas devices, make sure that the skylight and window are open.
- ▶ During activation and operation of the gas cooker, no flammable objects or highly inflammable objects such as dishcloths, napkins etc. must be near the gas cooker. Fire hazard!
- ▶ The process of ignition must be visible from above and must not be covered by cooking pans placed on the cooker.
- ▶ The gas cooker cover is held closed by a spring. When closing there is danger of getting injured!



- ▷ Do not use the glass gas cooker cover as a hob.
- ▷ Do not close the gas cooker cover while the gas cooker is in operation.
- ▷ Do not apply pressure on the gas cooker cover when it is closed.
- ▷ Keep the gas cooker cover open after cooking until the burners are cool. Otherwise the glass plate could shatter.



- ▷ Only use pots and pans whose diameter is appropriate for the gas cooker burners.
- ▷ When the flame goes out, the thermocouple automatically cuts the gas supply.
- ▷ Further information can be obtained in the manufacturer's instruction manual.

The vehicle kitchen unit is fitted with a gas cooker of 2 or 3 burners.

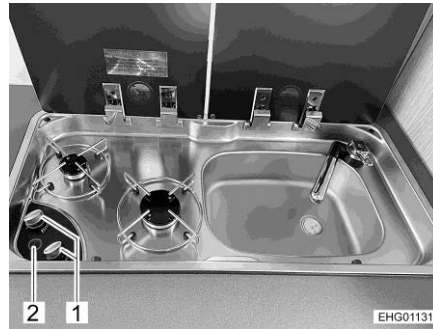

Fig. 228 Gas cooker, 2 burners



Fig. 229 Gas cooker, 3 burners

- Switching on:**
- Open the regulator tap on the gas bottle and the gas isolator tap "Cooker".
  - Open the gas cooker cover.
  - Turn the control knob (Fig. 228,1 or Fig. 229,1) on the burner you wish to use to the ignition position (large flame).
  - Press the control knob down and hold it.
  - Press push button (Fig. 228,2) or rocker button (Fig. 229,2). An ignition spark is created at the burner. If necessary, press the push button several times.
  - Once the flame is burning, keep the control knob pressed for another 10 to 15 seconds, until the thermocouple automatically keeps the gas supply open.
  - Release the control knob and turn to the desired setting.
  - If ignition is unsuccessful, repeat the entire procedure.
- Switching off:**
- Turn the control knob to the "0" position. The flame fades.
  - Close the gas isolator tap "Cooker" and the regulator tap on the gas bottle.



### 10.4.2 Cooker with gas oven and grill

The vehicle's kitchen unit is equipped with a cooker consisting of a gas grill and a gas oven.

**Cooker** The vehicle's cooker is equipped with 3 gas burners.



- ▶ During the lighting process and once a gas burner is in operation, keep all flammable objects or highly inflammable objects such as dish-cloths, napkins etc. away from the burner. Fire hazard!
- ▶ When lighting a gas burner, the burner must be visible from above, i.e. it must not be obscured by cooking pans placed on the cooker.
- ▶ If the burner flame is accidentally extinguished, turn the control knob to the "0" position and leave the burner off for at least 1 minute. Then ignite it again.
- ▶ The cooker cover is closed by spring force. When closing there is danger of getting injured!



- ▷ Do not attempt to cook on the cooker cover.
- ▷ Do not close the cooker cover while the cooker is in use.
- ▷ Do not apply pressure to the cooker cover when it is closed.
- ▷ Do not place hot cooking pans on the cooker cover.
- ▷ After cooking, leave the cooker cover open until the gas burners have cooled down. Otherwise the glass plate could shatter.



- ▷ Only use pots and pans whose diameter is appropriate for the gas cooker burners.
- ▷ When the flame on a gas burner goes out, the thermocouple automatically cuts the gas supply.
- ▷ Further information can be obtained in the manufacturer's instruction manual.

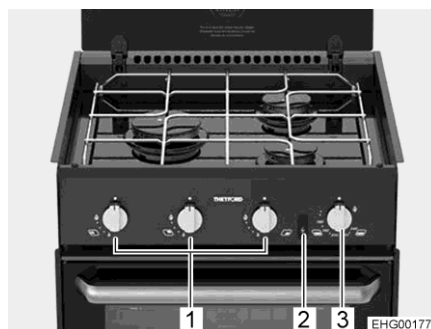

Fig. 230 Cooker with gas burners

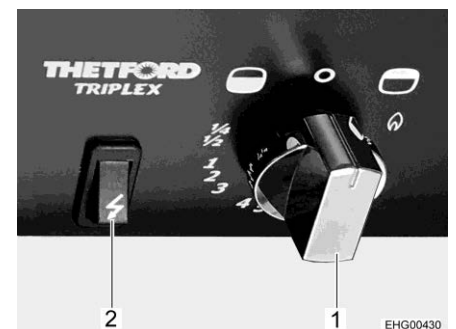

Fig. 231 Operating controls (gas oven with grill)

**Gas burners** The cooker is equipped with 3 gas burners.

**Turning on a gas burner:**

- Open the regulator tap on the gas bottle and the gas isolator tap "Cooker".
- Open the cooker cover.

- Press control knob (Fig. 230,1) of the desired burner, turn it to the ignition position (large flame), and hold it until the flame is burning (for a maximum of 15 seconds).
- Once the flame is burning, the control knob must be held down until the thermocouple keeps the gas supply open.
- Release the control knob and turn to the desired setting.
- If the flame fails to light, wait 1 minute and repeat the procedure from the start.

#### Turning off a gas burner:

- Turn the control knob to the "0" position. The flame fades.
- Close the gas isolator tap "Cooker" and the regulator tap on the gas bottle.

#### Gas oven with grill



- ▶ Keep the ventilation openings on the gas oven open at all times.
- ▶ There must be no flammable or highly inflammable objects such as dishcloths, clothes, etc. near the gas oven when the oven/grill is being lit and during operation. Fire hazard!
- ▶ When lighting the grill and when grilling, the flap of the gas grill must always remain open.
- ▶ If ignition has not taken place, repeat the entire procedure. If necessary, check if there is gas and/or current in the gas oven.
- ▶ If the gas oven/grill still does not work, close the gas isolator tap and notify your service centre.
- ▶ If the burner flame is accidentally extinguished, turn the control knob to the "0" position and leave the burner off for at least 1 minute. Then ignite it again.
- ▶ When grilling, pull out the heat guard and leave the flap fully open.



- ▷ Before using the gas oven for the first time run it for 30 minutes at maximum temperature without any contents.
- ▷ When the flame goes out, the thermocouple automatically cuts the gas supply.
- ▷ Further information can be obtained in the manufacturer's instruction manual.

#### Switching on:

- Open the regulator tap on the gas bottle and the gas isolator tap "Oven".
- Completely open oven flap.

#### Switching on the oven:

- Press the control knob (Fig. 230,3 and Fig. 231,1) and set it to the maximum setting anticlockwise (towards the oven symbol "🔥").
- Press the control knob (Fig. 230,3 and Fig. 231,1) and hold it down for 5 to 10 seconds. Gas will stream into the burner.
- Keep the ignition switch (Fig. 230,2 and Fig. 231,2) pressed until the flame burns.
- Once the flame is burning, keep the control knob pressed for another 10 to 15 seconds, until the thermocouple automatically keeps the gas supply open.
- Release the control knob and turn to the desired setting.

- Switching on the grill:**
- Press the control knob (Fig. 230,3 and Fig. 231,1) and turn it clockwise (towards the grill symbol "") in the direction of the flame symbol.
  - Press the control knob (Fig. 230,3 and Fig. 231,1) and hold it down for 5 to 10 seconds. Gas will stream into the burner.
  - Keep the ignition switch (Fig. 230,2 and Fig. 231,2) pressed until the flame burns.
  - Once the flame is burning, keep the control knob pressed for another 10 to 15 seconds, until the thermocouple automatically keeps the gas supply open.
  - Release the control knob and turn to the desired setting.
- Switching off:**
- Turn control knob (Fig. 231,1) to "O". The flame fades.
  - Close the gas isolator tap "Oven" and the regulator tap on the gas bottle.

### 10.4.3 Microwave oven (optional equipment)



- ▶ Only qualified personnel may repair the microwave oven. Improper repairs can cause major risks to the user.
- ▶ The protection device against the escape of microwave energy should never be removed.
- ▶ Use the microwave oven only if it has been properly installed.
- ▶ Only use the microwave oven when the door seal is free of damage.
- ▶ Never leave the microwave oven unattended when it is in operation.
- ▶ If there is smoke, keep the microwave oven closed, switch it off and interrupt the power supply.



- ▷ Operate the microwave oven only with the rotary plate and the rotary cross in place.
- ▷ Use only crockery suitable for microwave use.
- ▷ Only operate the microwave with appropriate contents and never run it empty.



- ▷ For cooking times under 2 minutes: First twist the cooking time control knob past "2" and then twist it back to the desired cooking time.
- ▷ Further information can be obtained in the manufacturer's instruction manual.



Fig. 232 Operating controls (microwave oven)

- Switching on:**
- Press the key (Fig. 232,3) to open the door and place food into the cooking area.
  - Close the door. A clicking noise can be heard when it engages.
  - Select the output on the control knob (Fig. 232,1).
  - Select the cooking time with the control knob (Fig. 232,2). Cooking begins.

The end of the cooking process is signaled by a signal tone. The microwave oven will switch off automatically.

- Switching off:**
- Press the key (Fig. 232,3) to open the door and take out the food.

#### 10.4.4 Extractor hood (optional equipment)

Depending on the equipment, the cooker is equipped with an extractor hood (vented **or** recirculating).

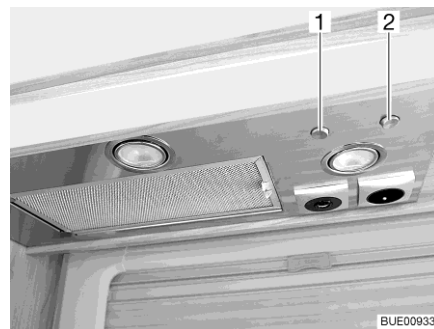

Fig. 233 Vented extractor hood



Fig. 234 Recirculating extractor hood

##### Vented extractor hood

The kitchen fumes are aspirated above the cooker, cleaned with the aid of a metal grease filter, and blown directly to the outside.

To switch on the extractor hood, press the flip switch (Fig. 233,2).

Use the flip switch (Fig. 233,1) to switch on the two lights in the extractor hood.

**Recirculating extractor hood**

The kitchen fumes are aspirated above the cooker, cleaned with the aid of a metal grease filter and an active carbon filter. The cleaned air is then conducted back into the interior of the vehicle.

To switch on the extractor hood, press the flip switch (Fig. 234,1).



- ▷ Further information can be obtained in the manufacturer's instruction manual.

**10.5 Refrigerator**

During the journey, only operate the refrigerator via the 12 V power supply. At high ambient temperatures the refrigerator is unable to reach its full cooling power.



- ▷ When leaving the vehicle, always mount the refrigerator ventilation grill. Otherwise water can enter during rain.
- ▷ The cooling power of the refrigerator depends on the vehicle setup. The cooling power can decrease if the vehicle is inclined by 5° or more. Therefore, always park the vehicle on level ground.
- ▷ Absorption refrigerators operate at normal room temperature (approx. 21 °C) within the specified temperature range. At significantly higher ambient temperatures (> 30 °C), the cooling power is reduced.
- ▷ Observe the safety instructions and manufacturer's instruction manual.

**10.5.1 Refrigerator ventilation grill**

At high external temperatures, the full cooling power of the cooling unit is only guaranteed if the refrigerator is ventilated sufficiently. In order to achieve a better ventilation the refrigerator ventilation grill can be removed.

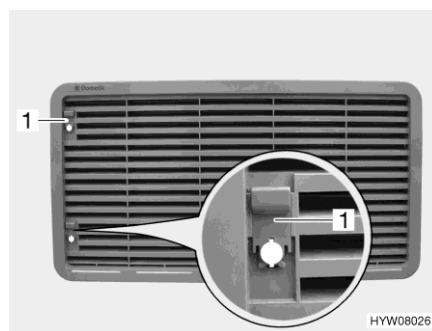

Fig. 235 Refrigerator ventilation grill (with sliding trap)



Fig. 236 Refrigerator ventilation grill (with screw)

- Removing:**
- Depending on the design, push the sliding trap (Fig. 235,1) upwards or turn the screw (Fig. 236,1) a quarter turn using a coin.
  - Remove refrigerator ventilation grill.

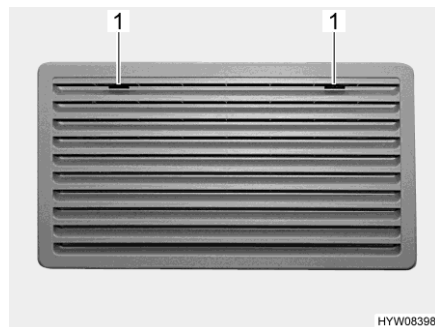

Fig. 237 Refrigerator ventilation grill (Thetford large)

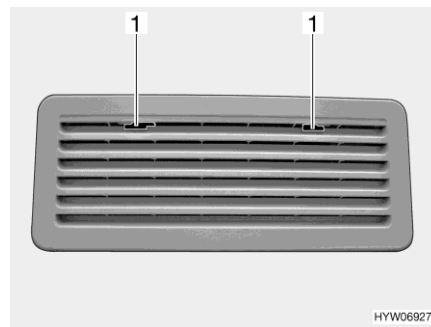

Fig. 238 Refrigerator ventilation grill (Thetford small)

- Removing:
- Move the locking device (Fig. 237,1 or Fig. 238,1) to the middle.
  - Remove refrigerator ventilation grill.

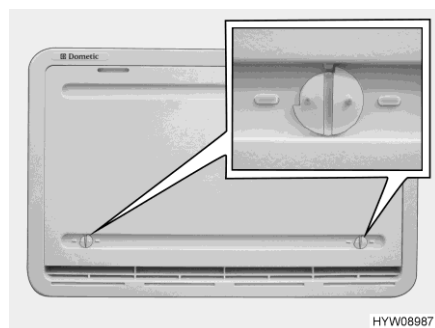

Fig. 239 Winter cover

#### Winter cover

If the refrigerator is to be operated at low external temperatures, the manufacturer recommends the use of a winter cover (Fig. 239) for the refrigerator ventilation grills.

The table below shows the temperature ranges in which the winter cover or the insulated winter cover may be used.

Temperature	Cover
Below 10 °C	Winter cover (for refrigerators with capacity below 130 litres: fit only on the lower ventilation grill)
Below -5 °C	Insulated winter cover (fit only on the lower ventilation grill)



- ▷ If the temperatures are higher than the indicated values, it is absolutely necessary to remove the winter cover. Otherwise the vehicle could be damaged.

- Mounting:
- Open both locks (Fig. 239) (groove in horizontal position).
  - Put winter cover in front of the ventilation grill.
  - Lock the locks with a small coin (groove in vertical position).
- Removing:
- Open both locks (Fig. 239) (groove in horizontal position).
  - Remove winter cover from ventilation grill.



- ▷ The winter cover may remain mounted during the journey.

### 10.5.2 Dometic Automatic (series 10)

This refrigerator is an absorber refrigerator with a separate freezer compartment.

The operating modes and the settings are shown on a TFT display (Fig. 240) or a LED display (Fig. 241) between refrigerator and freezer compartment.

#### Operating modes

The refrigerator is equipped with an automatic system to select the type of power. The refrigerator automatically selects the optimum energy source. Manual intervention to select the type of power is possible but not required.

The refrigerator selects from the following energy sources:

- 230 V AC
- 12 V DC
- Gas

Choosing the available energy source highest on the list.



- ▷ The refrigerator always requires a 12 V control voltage, regardless of which type of energy it is using. The control voltage is drawn from the living room area battery. Therefore the closed circuit current always flows even if the refrigerator is switched off. Always disconnect the refrigerator from the battery for a temporary lay-up.

#### 230 V operation

If the operating mode "AUTO" or "A" has been set and the 230 V power supply is connected, this energy source is the preferred selection.

#### 12 V operation

If the operating mode "AUTO" or "A" has been set, the refrigerator only selects the 12 V operation if the vehicle engine is running.

#### Gas operation



- ▶ Never let gas escape unburned due to danger of explosion.
- ▶ Use only liquefied gas to operate the refrigerator; do not use natural gas.
- ▶ At altitudes above 1000 m, there may be problems igniting the gas. If possible, change to another type of energy.



- ▷ If LPG is used, the gas burner must be cleaned more frequently.
- ▷ Open the regulator tap on the gas bottle and the gas isolator tap "Refrigerator".

If the operating mode "AUTO" or "A" has been set, the 230 power supply is **not** connected, and the vehicle engine is **switched off**, the refrigerator selects the gas supply. When selecting gas operation the ignition fuse is opened automatically so gas can get into the burner. At the same time the electronic ignition is activated. If the gas flame is extinguished, e.g. by blast of wind, the ignition is activated immediately and re-ignites the gas.

**Change-over between energy sources**

Change-over delay times are integrated for switching from the energy sources 230 V or 12 V to gas. For example, when switching from 12 V operation to gas operation, a 15-minute delay is designated. This prevents a change-over to gas operation when the vehicle is stopped briefly and the engine is switched off (e.g. stop to fill tank).

**Stop to fill tank**

- ▶ Open flames are prohibited at petrol stations.

If the refrigerator was manually set for gas operation during the journey: switch off the refrigerator in the petrol station area or change over to 12 V operation.

If the refrigerator was operated in the automatic mode during the journey and the stop for filling the tank takes longer than 15 minutes: switch off the refrigerator. Otherwise, the refrigerator will automatically change over to gas operation 15 minutes after stopping the vehicle engine.

**Refrigerating temperature control**

After switching on, the refrigerator automatically selects a medium cooling power (normal operating temperature). It can take several hours until this medium cooling power is reached.

If a higher or lower cooling power is desired, the cooling power can be changed manually. The changed setting is retained even if another operating mode is selected.

The higher the cooling power at which the refrigerator operates, the more bars are shown in the cooling level indicator (Fig. 240,2 or Fig. 241,2).

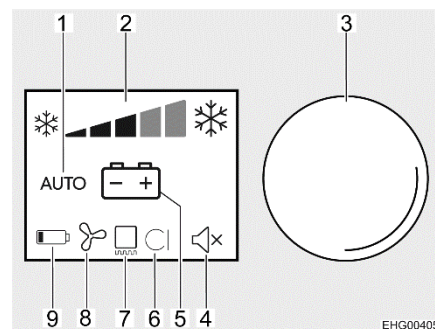
**Refrigerator with TFT display**

- 1 Automatic mode indicator
- 2 Cooling level indicator
- 3 Control knob
- 4 Alarm tone indicator
- 5 Display of current energy source
- 6 Not used
- 7 Frame heater indicator
- 8 Fan indicator (optional)
- 9 Not used

Fig. 240 TFT display



- ▷ Selected settings are displayed in blue.

**Switching on:**

- Open the regulator tap on the gas bottle and the gas isolator tap "Refrigerator".
- Press and hold the control knob (Fig. 240,3) for about 2 seconds. The refrigerator switches on with the settings selected most recently.



- Setting the cooling power:**
- Turn the control knob until the top display line is active.
  - Press the control knob.
  - Turn control knob until the desired cooling level (Fig. 240,2) is displayed.
  - Press the control knob.
- Selecting operating mode:**
- Turn the control knob until the middle display line is active.
  - Press the control knob.
  - Turn control knob until the desired operating mode (Fig. 240,1 and 5) is displayed.
  - Press the control knob.
- Switching on/off the frame heater (FH):**
- Turn the control knob until the bottom display line is active.
  - Press the control knob.
  - Turn control knob until the frame heater (Fig. 240,7) is activated or deactivated.
  - Press the control knob.



- ▷ At high outside temperatures or high humidity, the frame heater reduces condensation on the freezer compartment.
- ▷ When using the frame heater, bear in mind that the frame heater consumes some electrical current (4 watts) even in gas operation and can discharge the living area battery as a result. Therefore, do not use the frame heater permanently in gas operation.

- Switching off:**
- Press and hold the control knob (Fig. 240,3) for about 4 seconds. The refrigerator switches itself off. All displays close.
  - Close the gas isolator tap "Refrigerator" and the regulator tap on the gas bottle.

### Refrigerator with LED display

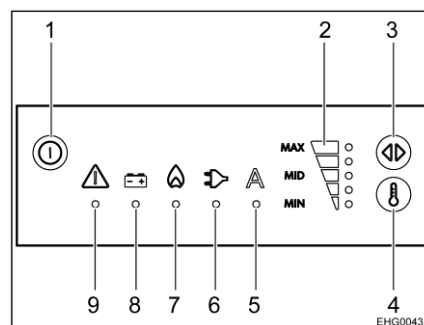

- 1 On/Off button
- 2 Cooling level indicator
- 3 Operating mode selection button
- 4 Temperature setting button
- 5 Automatic mode indicator
- 6 230 V operation indicator
- 7 Gas operation indicator
- 8 12 V operation indicator
- 9 Fault indicator

Fig. 241 LED display



- ▷ Selected settings are indicated by the associated LED lighting up.

- Switching on:**
- Open the regulator tap on the gas bottle and the gas isolator tap "Refrigerator".
  - Press and hold the On/Off button (Fig. 241,1) for about 2 seconds. The refrigerator switches on with the settings selected most recently.
- Setting the cooling power:**
- Press the temperature setting button (Fig. 241,4) until the desired cooling level (Fig. 241,2) is displayed.
- Selecting operating mode:**
- Press the operating mode selection button (Fig. 241,3) until the desired operating mode (Fig. 241,5 to 8) is activated.
- Switching off:**
- Press and hold the On/Off button (Fig. 241,1) for about 4 seconds. The refrigerator switches itself off. All displays close.
  - Close the gas isolator tap "Refrigerator" and the regulator tap on the gas bottle.



- ▷ Further information can be obtained from the separate instruction manual "Refrigerator".

### 10.5.3 Thetford, series N4000

This refrigerator is an absorber refrigerator with freezer compartment. The operating modes and settings are shown on a LED display.

#### Operating modes

The refrigerator is equipped with an automatic system to select the type of power. The refrigerator automatically selects the optimum energy source. Manual selection of the energy source is also possible.

The refrigerator has the following operating modes:

- 230 V operation
- 12 V operation
- Gas operation



- ▷ The refrigerator always requires a 12 V control voltage regardless of which type of energy it is using. The control voltage is present as soon as the transformer/rectifier is switched on. Therefore the closed circuit current always flows even if the refrigerator is switched off. Always switch off the transformer/rectifier for a temporary lay-up.
- ▷ Close the gas isolator tap "Refrigerator" when the refrigerator is operated electrically.

#### 230 V operation

The refrigerator is operated via an external power supply.

#### 12 V operation

The refrigerator is operated via the vehicle battery.



- ▷ In the automatic mode, the 12 Volt operation is only selected, when the vehicle engine is running.

**Gas operation** The refrigerator is operated with gas from a connected gas bottle.



- ▷ If LPG is used, a filter must be used. The filter must be installed by a qualified technician.

### Change-over between energy sources

During change-over between the different energy sources, intended delays are installed in the version with automatic power selection. This means, that after a change-over to a new energy source the refrigerator can not be operated immediately. When changing from 12 Volt operation to gas operation, the delay is 15 minutes. This prevents a change-over to gas operation when the vehicle is stopped briefly (e.g. stop to fill tank).

### Stop to fill tank



- ▶ Open flames are prohibited at petrol stations.  
If the refrigerator was manually set for gas operation during the journey: switch off the refrigerator in the petrol station area or change over to 12 V operation.  
If the refrigerator was operated in the automatic mode during the journey (only in the case of the version with automatic power selection) and the stop for filling the tank takes longer than 15 minutes: switch off the refrigerator. Otherwise, the automatic power selection system will automatically change over to gas operation 15 minutes after stopping the vehicle engine.

### Ignition fuse

When selecting gas operation the ignition fuse is opened automatically so gas can get into the burner. At the same time the electronic ignition is activated. If the gas flame is extinguished, e.g. by blast of wind, the ignition is activated immediately and re-ignites the gas.

### Operation

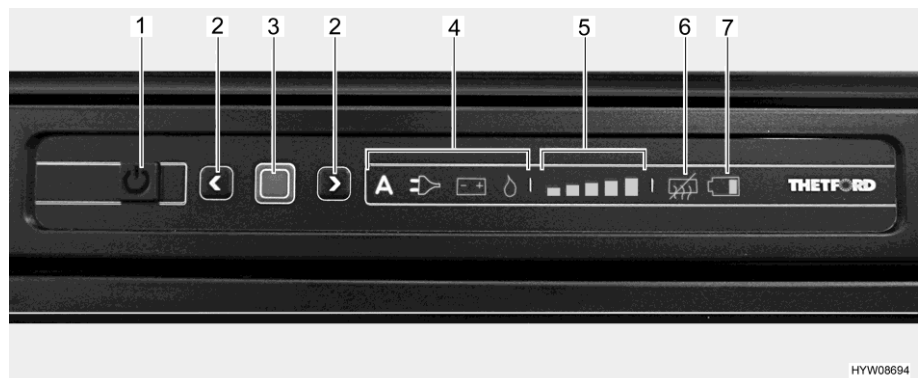

Fig. 242 LED operating panel (Thetford refrigerator)

- 1 On/Off button
- 2 Arrow keys
- 3 Confirmation button
- 4 Display of operating mode ("A" does not exist in all versions)
- 5 Cooling level indicator
- 6 Display "Anti-condensation off"
- 7 Display "Battery flat" (optional)



- ▷ If the refrigerator shall be operated with gas: open the regulator tap on the gas bottle and the gas isolator tap "Refrigerator".

- Switching on:**
- Press and hold the On/Off button (Fig. 242,1) for 1 second. The button lights up green. To save energy, after approximately 10 seconds the display is dimmed.
  - Press confirmation button (Fig. 242,3). The operating mode previously selected is displayed.

- Selecting operating mode:**
- Press and hold the confirmation button (Fig. 242,3) for about 2 seconds. The operating mode symbols flash.
  - Manual power selection: use the arrow keys (Fig. 242,2) to select the desired energy source.
  - Automatic power selection (only version with automatic power selection): use the arrow keys (Fig. 242,2) to select the operating mode "A".
  - Confirm your selection with the confirmation button (Fig. 242,3).

In the case of the version with automatic power selection, the power selection is carried out in the following order as a function of the availability of the energy sources:

- 230 V AC
- 12 V DC
- Gas

- Setting the refrigerating temperature:**
- Press and hold the confirmation button (Fig. 242,3) for about 2 seconds. The operating mode symbols flash.
  - Press confirmation button (Fig. 242,3) again. The cooling level indicator (Fig. 242,5) flashes.
  - To change the setting, press the arrow keys (Fig. 242,2) until the desired setting is displayed.
  - Confirm your selection with the confirmation button (Fig. 242,3).

- Switching off:**
- Press and hold the On/Off button (Fig. 242,1) for about 2 seconds. All lights go out. Refrigerator is switched off.
  - If the refrigerator had been operated with gas: close the gas isolator tap "Refrigerator" and the regulator tap on the gas bottle.

### Refrigerating temperature control

After switching it on, the refrigerator automatically selects the previously selected thermostat position. This position can be adjusted manually by using the arrow keys (Fig. 242,2). It takes a few hours till the refrigerator reaches its normal operating temperature. When changing over to another operating mode, the thermostat setting is kept.

### Additional functions

Flashing lamps on the operating unit indicate a fault. For instructions regarding troubleshooting, see section 15.10.3.



- ▷ Further information can be obtained from the separate instruction manual "Refrigerator".

### 10.5.4 Thetford T2000



- ▶ Due to technical reasons, the temperature in the refrigerator and in the freezer compartment cannot always be maintained at a constant level. Under adverse conditions, the food in the freezer compartment may thaw and spoil.



- ▷ Heat is generated during operation. To prevent the refrigerator from overheating: always keep ventilation openings clear.
- ▷ Do not place hot objects in the refrigerator to speed up defrosting. Do not defrost the refrigerator with a hot air dryer or similar.
- ▷ Switch off the refrigerator for cleaning.



- ▷ The living area battery has a limited power supply only. Therefore, do not operate the refrigerator for a longer period of time when the vehicle is stationary and not connected to a 230 V supply.
- ▷ Further information can be obtained in the manufacturer's instruction manual.

#### Energy supply

The refrigerator is only operated with 12 V DC.

When the vehicle is in motion, the transformer/rectifier feeds the power from the alternator of the vehicle to the refrigerator.

When the vehicle is stationary and **not** connected to the 230 V power supply, the transformer/rectifier supplies the refrigerator with power from the living area battery.

When the vehicle is stationary and connected to the 230 V power supply, the transformer/rectifier transforms the input voltage to 12 V and then supplies this current to the refrigerator.

Conversion between the individual supply types is automatic.

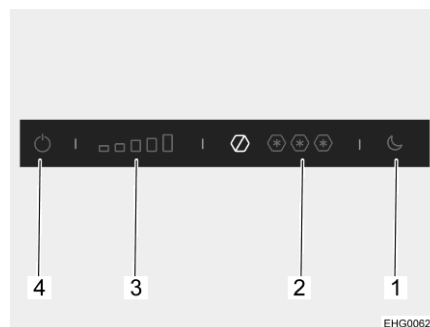

- 1 Night mode button
- 2 Cooling level indicator Freezer compartment
- 3 Cooling level indicator Refrigerator
- 4 On/Off button

Fig. 243 Operating controls (refrigerator)

- Switching on:** ■ Press the On/Off button (Fig. 243,4) and hold for a few seconds. The blue indicator lamp shows that the refrigerator is working. The cooling level indicator Refrigerator (Fig. 243,3) shows the set cooling level.
- Switching off:** ■ Press the On/Off button (Fig. 243,4) and hold for a few seconds. The blue indicator lamp will go out.



- ▷ The cooling effect depends on the ambient temperature and also on how many foods to be cooled are placed in the refrigerator and how often the refrigerator door is opened. At high ambient temperatures, a higher cooling level must be set; at low ambient temperatures, a lower cooling level is sufficient.

Setting the cooling level: ■ Press the desired cooling level for the refrigerator (Fig. 243,3).

Setting the freezing level: ■ Press the desired cooling level for the freezer compartment (Fig. 243,2).

The refrigerator has a night mode. When the night mode is switched on, the refrigerator works silently with lower power.

Switching on the night mode: ■ Press the night mode button (Fig. 243,1). The blue indicator lamp shows that the night mode is active.

Switching off the night mode: ■ Press the night mode button (Fig. 243,1). The blue indicator lamp will go out. The refrigerator is working in normal mode again.

During operation, condensation may collect in the collection tray underneath the freezer compartment. The collection tray must therefore be emptied periodically.



- ▷ Further information can be obtained in the manufacturer's instruction manual.

### 10.5.5 Dellcool (compressor)



- ▶ Due to technical reasons, the temperature in the refrigerator and in the freezer compartment cannot always be maintained at a constant level. Under adverse conditions, the food in the freezer compartment may thaw and spoil.



- ▷ Heat is generated during operation. To prevent the refrigerator from overheating: always keep ventilation openings clear.
- ▷ Do not place hot objects in the refrigerator to speed up defrosting. Do not defrost the refrigerator with a hot air dryer or similar.
- ▷ Switch off the refrigerator for cleaning.



- ▷ The living area battery has a limited power supply only. Therefore, do not operate the refrigerator for a longer period of time when the vehicle is stationary and not connected to a 230 V supply.
- ▷ Further information can be obtained in the manufacturer's instruction manual.

**Energy supply** The refrigerator is only operated with 12 V DC.

When the vehicle is in motion, the transformer/rectifier feeds the power from the alternator of the vehicle to the refrigerator.

When the vehicle is stationary and **not** connected to the 230 V power supply, the transformer/rectifier supplies the refrigerator with power from the living area battery.

When the vehicle is stationary and connected to the 230 V power supply, the transformer/rectifier transforms the input voltage to 12 V and then supplies this current to the refrigerator.

Conversion between the individual supply types is automatic.

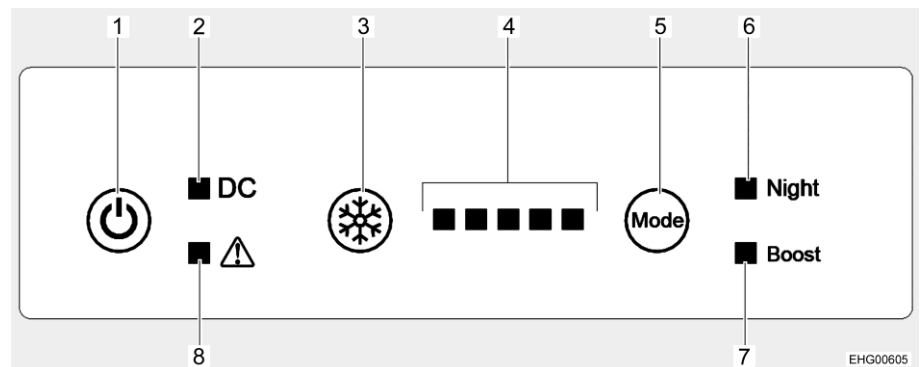

Fig. 244 Operating controls (refrigerator)

- 1 On/Off button
- 2 Operation indicator lamp
- 3 Button for cooling level
- 4 Cooling level setting indicator lamps
- 5 Operating mode button
- 6 Night mode indicator lamp
- 7 Boost mode indicator lamp
- 8 Fault warning light

**Switching on:** ■ Press the On/Off button (Fig. 244,1). All indicator lamps light up (light test) and go out after approx. 3 seconds. Only the operation indicator lamp (Fig. 244,2) remains lit, indicating that the refrigerator is working. The compressor starts after a short delay.

**Switching off:** ■ Press the On/Off button (Fig. 244,1). The Operation indicator lamp (Fig. 244,2) goes out.



▷ The cooling effect depends on the ambient temperature and also on how many foods to be cooled are placed in the refrigerator and how often the door is opened.

**Setting the cooling level:** ■ Press the button for cooling setting (Fig. 244,3) repeatedly until the desired cooling level is displayed. The more indicator lamps (Fig. 244,4) are lit, the higher the cooling power (and also the energy consumption).

In addition to normal cooling mode, the refrigerator has two additional operating modes:

- Night mode: When the night mode is switched on, the refrigerator operates at lower power and is therefore quieter.
- Boost mode: When the boost mode is switched on, the refrigerator operates at high power to cool as quickly as possible.

- Switching on the night mode: ■ Press the operating mode button (Fig. 244,5) repeatedly until the night mode indicator lamp (Fig. 244,6) is lit. The refrigerator is now working in night mode.
- Switching off the night mode: ■ Press the operating mode button (Fig. 244,5) repeatedly until the night mode indicator lamp (Fig. 244,6) goes out. The refrigerator is working in normal mode again.
- Switching on the boost mode: ■ Press the operating mode button (Fig. 244,5) repeatedly until the boost mode indicator lamp (Fig. 244,7) is lit. The refrigerator is now working in boost mode.
- Switching off the boost mode: ■ Press the operating mode button (Fig. 244,5) repeatedly until the boost mode indicator lamp (Fig. 244,7) goes out. The refrigerator is working in normal mode again.



- ▷ Further information can be obtained in the manufacturer's instruction manual.

### 10.5.6 Refrigerator door locking mechanism

The specifications in this section correspondingly also apply to the door of the freezer compartment.



- ▷ During the journey the refrigerator door must always be closed and locked in the closed position.



- ▷ Lock the refrigerator door in ventilation position when the refrigerator is switched off. This prevents mould forming.

There are two positions for locking the refrigerator door in place:

- Closed refrigerator door during travel and when the refrigerator is in operation
- Slightly opened refrigerator door as a ventilation position when the refrigerator is switched off

#### Dometic 10 series

The refrigerator door can be locked in the slightly open position.

#### Bringing refrigerator door to ventilation position:

- Defrost the refrigerator.
- On one side, unscrew the hook as far as it will go both on the top and at the bottom of the door in the area of the lock.
- Press refrigerator door on. The protruding pin snaps into the hook. The refrigerator door is in the ventilation position.

#### Bringing refrigerator door to operating position:

- Open the refrigerator door.
- Press the protruding hooks on the top and the bottom of the refrigerator door in again. The refrigerator door is in operating position again.



**Thetford** The refrigerator is opened and closed with the handle on the door.

**Opening:** ■ Press the handle to the side, keep it pressed and open the refrigerator door.

**Closing:** ■ Close the refrigerator door. The lock hook engages audibly.

**Ventilation position** The refrigerator door may be locked in ventilation position with a swivelling bracket.



Fig. 245 Locking device in normal position



Fig. 246 Locking device in ventilation position

**Locking:** ■ Open the refrigerator door.  
 ■ Swing the bracket (Fig. 245,1) to the front (Fig. 246).

If the refrigerator door is closed now, a gap will remain towards the refrigerator.

**Dellcool** The refrigerator is opened and closed with the handle on the door.

**Ventilation position** The refrigerator door can be locked in ventilation position. In order to do this, the locking device can be shifted.

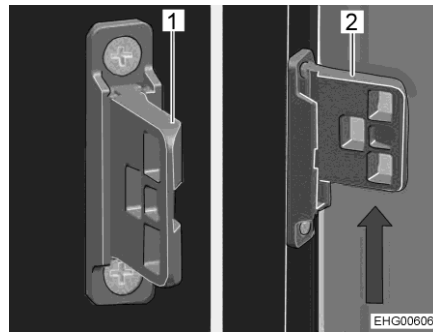

- 1 Locking device in normal position
- 2 Locking device in ventilation position

Fig. 247 Locking device

Bringing locking device to ventilation position:

- Open the refrigerator door.
- Push the locking device upwards (Fig. 247,2).

If the refrigerator door is closed now, a gap will remain towards the refrigerator.

Bringing locking device to normal position:

- Open the refrigerator door.
- Push the locking device downwards (Fig. 247,1).

The refrigerator door can now be closed completely.

## Chapter overview

This chapter contains instructions regarding the sanitary fittings of the vehicle.

### 11.1 Water supply, general



- ▶ Fill water tank from supply systems that have been verified to provide drinking water quality.
- ▶ Only use such hoses or containers when filling that have been approved for use with drinking water.
- ▶ Thoroughly rinse filling hose or container with drinking water before use (2 to 3 times capacity).
- ▶ Empty filling hose or container completely after use and close openings of the filling hose or container.
- ▶ Water left standing in the water tank or in the water pipes becomes undrinkable after a short period. Therefore, before each use of the vehicle, thoroughly clean the water pipes and the water tank. After each use of the vehicle completely empty the water tank and the water pipes.
- ▶ In the case of lay-ups lasting more than a week disinfect the water system before using the vehicle (see chapter 12).



- ▷ If the vehicle is not used for several days or if it is not heated when there is a risk of frost, empty the entire water system. Make certain that the water pump is switched off. Otherwise, the water pump will overheat and may get damaged. Leave the water taps on in central position. Leave all drain cocks open. Frost damage to appliances, frost damage to the vehicle and deposits in water-carrying components can be avoided in this way.
- ▷ The water pump will overheat without water and can get damaged after one minute at the latest. Never operate water pump when the water tank is empty.

The vehicle is equipped with a fitted water tank. An electric water pump pumps the water to the individual water taps. Opening a water tap automatically switches on the water pump and pumps water to the tap.

The waste water tank collects the waste water. The water level in the water and waste water tanks can be checked on the panel.



- ▷ Before the water fittings can be used, the 12 V power supply on the panel must be switched on. Otherwise the water pump will not work.
- ▷ When the water tank is re-filled, an air bubble may form at the bottom of the pump. This air bubble will prevent water from being drawn in. Shake the water pump up and down energetically in the water.

## 11.2 Water system

### 11.2.1 Water tank



- ▷ The water tank has a capacity of 125 litres or 120 litres (Lyseo TD).
- ▷ In order to increase the possible payload, the filling quantity of the water tank can be limited to 20 litres. In order to do this, open the overflow on the water tank. The rotary handle of the overflow is located on the water tank. If, after loading the vehicle, there is still a sufficiently large remaining payload, the water tank can be filled up to its actual capacity. To do this, close overflow.
- ▷ The fill level of the water tank can be called up on the panel.

### 11.2.2 Drinking water filler neck with cap



- ▶ If the drinking water filler neck is installed in the vehicle's side wall, the cap is very similar to the cap of the fuel filler neck. Before filling the tank, always check the label.

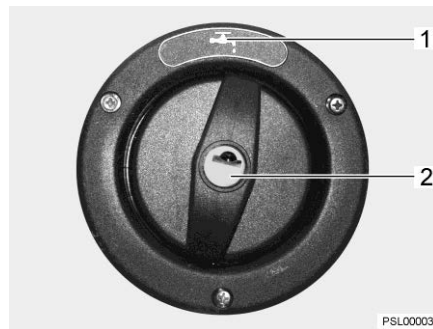

Fig. 248 Drinking water filler neck in the vehicle's side wall

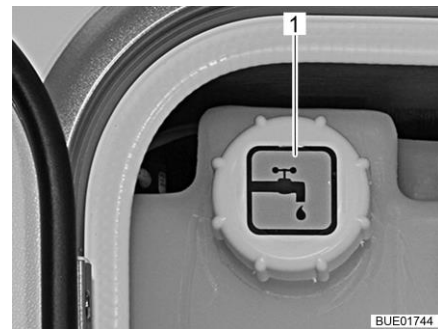

Fig. 249 Drinking water filler neck in service unit (alternative)

The drinking water filler neck is marked with the symbol "☰" (Fig. 248,1 or Fig. 249,1) and is installed either in the vehicle's side wall or in the service unit.

#### Drinking water filler neck in the side wall

The drinking water filler neck is installed outside, in the left-hand side wall of the vehicle.

The cap is opened and closed using the key for the external flap locks.

- Opening:**
- Insert key into locking cylinder (Fig. 248,2) and turn a quarter turn in an anticlockwise direction.
  - Remove the cap.
- Closing:**
- Place cap on the drinking water filler neck.
  - Turn key one quarter turn in a clockwise direction.
  - Remove the key.
  - Check that the cap sits firmly on the drinking water filler neck.

**Drinking water filler neck in the service unit**

The drinking water filler neck is part of the centralized supply unit (service unit). The central supply unit is installed behind the service flap on the left-hand side of the vehicle.

**11.2.3 Filling the water system**

- ▶ When filling the water tank, observe the maximum permissible gross weight of the vehicle. Luggage must be reduced accordingly when the water tank is full.



- ▷ The water pump will overheat without water and can get damaged. Never operate water pump when the water tank is empty.



- ▷ The Truma system (heater/boiler) has a safety/drainage valve and, depending on the model, one or two drain cocks for emptying.
- ▷ Depending on the model, the Alde system (heater/boiler) has one or two drain cocks for emptying.
- ▷ The water quantity can be monitored on the panel while the water tank is filled.

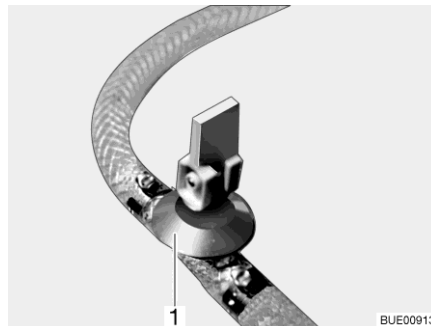

Fig. 250 Drain cock (with rocking lever)

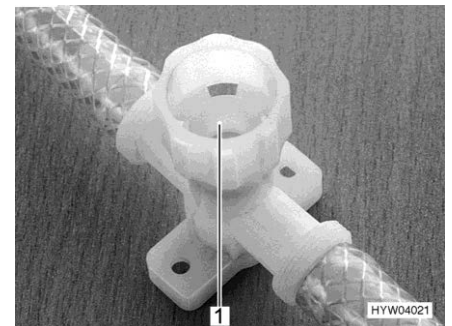

Fig. 251 Drain cock (with twist cap)

- Position the vehicle horizontally.
- Switch on the 12 V power supply on the panel.
- If necessary, switch on the water pump on the panel.
- Clean or disinfect water system.
- Close all drain cocks. To do this, position the drain cock's rocking lever (Fig. 250,1) horizontally or turn the drain cock's cap (Fig. 251,1) in a clockwise direction.

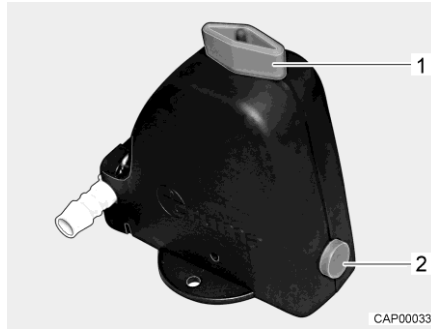

Fig. 252 Safety/drainage valve (Truma)

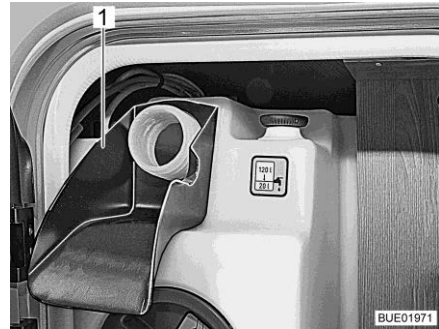

Fig. 253 Filling aid

- Close the safety/drainage valve (Truma). Turn the knob (Fig. 252,1) perpendicular to the safety/drainage valve and push the push button (Fig. 252,2) in.  
If the temperature is below 6 °C, the safety/drainage valve cannot be closed. Therefore switch on the living area heater and wait until the temperature of the safety/drainage valve exceeds 6 °C.
- Close the drainage opening of the water tank.
- Close all water taps.
- Open the drinking water filler neck on the outside of the vehicle.
- Plug the filling aid (Fig. 253,1) onto the drinking water filler neck.
- Fill the water tank with drinking water. Use a water hose, a water canister with a funnel or similar for filling.
- Set all the water taps to "Hot" and open them. The water pump is turned on. The warm water pipes are filled with water.
- Keep the water taps open until the water flowing out of the water taps has no bubbles in it. This is the only way to ensure that the boiler is full of water.
- Set all water taps to "Cold" and leave them open. The cold water pipes will be filled with water.
- Keep the water taps open until the water flowing out of the water taps has no bubbles in it.
- Close all water taps.
- Remove filling aid and close drinking water filler neck.
- Check that the cap on the water tank is not leaking.

#### Position of the drain cocks and safety/drainage valve

See chapter 17.

### 11.2.4 Topping up the water



► When filling the water tank, observe the technically permissible maximum laden mass of the vehicle. Luggage must be reduced accordingly when the water tank is full.

- Open drinking water filler neck.
- Fill the water tank with drinking water. Use a water hose, a water canister with a funnel or similar for filling.
- Close drinking water filler neck.

### 11.2.5 Closing/opening the overflow



► When filling the water tank, observe the technically permissible maximum laden mass of the vehicle. Luggage must be reduced accordingly when the water tank is full.



Fig. 254 Water tank (service unit)



Fig. 255 Water tank (alternative)

- Closing:**
- Turn the rotary handle (Fig. 254,1 or Fig. 255,1) on the water tank in a clockwise direction as far as it will go.
  - Fill the water tank with drinking water.
- Opening:**
- Turn the rotary handle (Fig. 254,1 or Fig. 255,1) on the water tank in an anticlockwise direction as far as it will go. Excess water will drain away leaving 20 litres in the tank.

### 11.2.6 Draining water (rotary handle with overflow)



Fig. 256 Water tank (service unit)



Fig. 257 Water tank (alternative)

- Turn the rotary handle (Fig. 256,1 or Fig. 257,1) on the water tank in an anticlockwise direction as far as possible beyond the resistance to fully open the drainage opening.

### 11.2.7 Emptying the water system



- ▷ If the vehicle is not used for several days or if it is not heated when there is a risk of frost, empty the entire water system. Make certain that the water pump is switched off on the panel. Otherwise, the water pump will overheat and may get damaged. Leave the water taps on in central position. Leave the safety/drainage valve (if there is one) and all drain cocks open. Frost damage to appliances, frost damage to the vehicle and deposits in water-carrying components can be avoided in this way.
- ▷ If the water pump can be turned off from the panel, always turn off the water pump from the panel before you empty the water system. Otherwise the water pump runs until it overheats or the battery is empty.



- ▷ The Truma system (heater/boiler) has a safety/drainage valve and, depending on the model, one or two drain cocks for emptying.
- ▷ Depending on the model, the Alde system (heater/boiler) has one or two drain cocks for emptying.

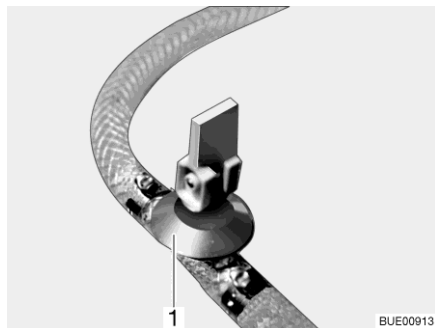

Fig. 258 Drain cock (with rocking lever)

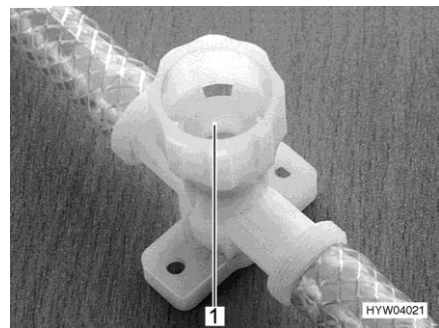

Fig. 259 Drain cock (with twist cap)



To empty and ventilate the water system, proceed as follows. This will avoid frost damage:

- Position the vehicle horizontally.
- Switch off water pump on panel.
- Switch off the 12 V power supply on the panel.
- Shut off the boiler (see section 10.2).
- Open all drain cocks. To do this, position the drain cock's rocking lever (Fig. 258,1) vertically or turn the drain cock's cap (Fig. 259,1) in an anti-clockwise direction.

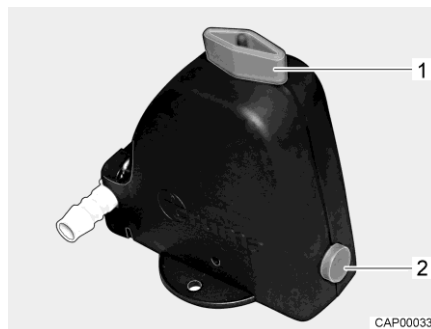

Fig. 260 Safety/drainage valve (Truma)

- Open the safety/drainage valve (Truma). To do this turn the knob (Fig. 260,1) parallel to the safety/drainage valve. The push button (Fig. 260,2) jumps out.
- Open the water tank drain.
- Open all water taps and set to the central position.
- Hang the shower handset up in the shower position.
- Unscrew the lock ring on the water tank.
- Take water pump (fitted to the cover) as far as the connecting lines allow.
- Hold the water pump up until the water pipes are completely empty.
- Check whether the water tank is completely empty.
- Set the shower handset down in the shower tray.
- Blow out the remaining water in the water pipes (max. 0.5 bar). In order to do this, remove the water pipe from the water pump and blow into the water pipe in the direction of the appliances.
- Empty the waste water tank. Take note of the environmental tips in this chapter.
- Empty toilet cassette or sewage tank. Take note of the environmental tips in this chapter.
- Clean the water tank and then rinse it out thoroughly.
- Let the water system dry for as long as possible.
- After emptying, leave all water taps on in the central position.
- Leave all drain cocks open.

## Position of the drain cocks and safety/drainage valve

See chapter 17.

### 11.3 Waste water installation



- ▷ Never pour boiling water directly into the sink outlet. Boiling water could cause deformation and leaks in the waste water pipe system.



- ▷ Only empty the waste water tank at disposal stations, camping sites or caravan sites especially provided for this purpose.

#### 11.3.1 Draining waste water



- ▷ If there is a risk of frost, empty the waste water tank and leave the drain cock open.



- ▷ If possible, place the vehicle in inclined position to drain the waste water.



Fig. 261 Drain cock symbol

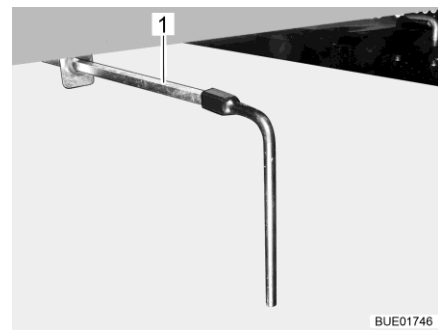

Fig. 262 Drain cock

The waste water tank is in a central position underneath the vehicle.

Waste water from the kitchen and washing unit flows through plastic pipes into the waste water tank.

The drain cock and the cleaning opening are located on the underside of the waste water tank.

The position of the drain cock is identified by a symbol (Fig. 261).

The waste water tank holds 90 litres.

#### Emptying:

- Park the vehicle such that the drainage opening is positioned above the disposal facility.
- Open the drain cock. To do this, attach the supplied square spanner onto the square of the drain cock (Fig. 262,1).
- To do this, turn the square spanner a quarter turn anticlockwise. The waste water is drained.

- Close the drain cock again once all of the waste water has run out. To do this, turn the square spanner a quarter turn clockwise.
- Remove the square spanner and store it.

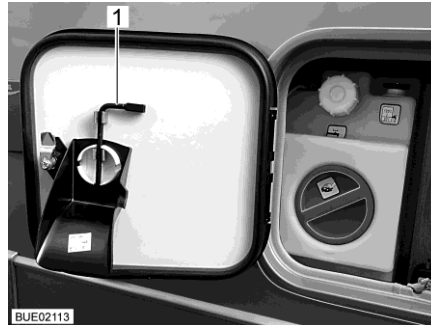

Fig. 263 Service flap with square spanner

If the vehicle is equipped with a service unit, the square spanner (Fig. 263,1) is fastened on the inside of the service flap.

### 11.3.2 Heater for waste water tank and waste water pipes (optional equipment)

In order to prevent waste water fittings freezing up, the waste water tank and the waste water pipes can be electrically heated separately.



- ▷ The heater for the waste water system requires up to 250 W during operation. Therefore, wherever possible, connect the vehicle to a 230 V power supply while the heater for the waste water system is working. The waste water heating continues to function even if the 12 V power supply is switched off on the panel.

In order to prevent the waste water installation from freezing, depending on the model and the equipment, the following components of the waste water system can be heated electrically:

- Waste water tank
- Waste water pipes
- Waste water tank and drainage

When the respective heater has been switched on, temperature sensors monitor the temperature of the waste water tank and the waste water pipes. If there is a risk of frost, the heating elements are switched on. If the temperature rises above a pre-set value, the heating elements are switched off again.

**Position** The heater for the waste water tank and the waste water pipes is normally installed in the bench seat.



Fig. 264 Switch for waste water heating

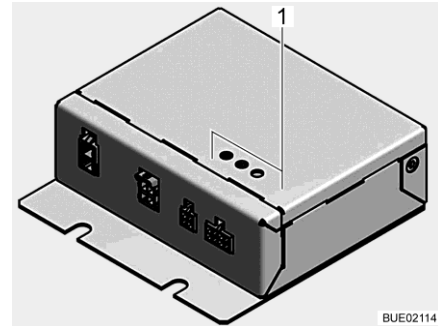

Fig. 265 Control unit for waste water heating

**Switching on:** ■ Press the upper part of the switch (Fig. 264). The waste water heating is switched on and prevents the heated components from freezing.

**Switching off:** ■ Press the lower part of the switch.

Three LEDs (Fig. 265,1) indicate the status of the control unit for the waste water heating:

LED HK 1 is lit	Heating circuit 1 is active
LED HK 2 is lit	Heating circuit 2 is active
LED HK 2 is flashing every 16 seconds	The device is in the power saving mode
LED ERR is flashing	The control has detected an error. Contact customer service



- ▷ Heating circuit 1 heats the waste water tank.
- ▷ Heating circuit 2 heats the waste water pipes and the waste water tank with emptying.
- ▷ If one of the two circuits (HK 1 or HK 2) is not connected, the LED assigned to the related heating circuit is flashing. This flashing is not an error message and may be ignored.

## 11.4 Toilet compartment



- ▷ Do not transport any loads in the shower tray. The shower tray or other items of equipment in the toilet compartment can be damaged.



- ▷ For ventilation purposes during or after a shower, and for drying wet clothing, close the toilet compartment door and open the window or the toilet compartment skylight. This improves the air circulation.
- ▷ Close the shower curtain completely when showering, so that no water is able to enter the area between the wash room wall and the shower tray.
- ▷ After taking a shower, rinse soap residue from the shower tray, otherwise cracks can appear in the shower tray over time.
- ▷ After using the shower, wipe it dry to prevent moisture from collecting.
- ▷ Further information about cleaning the toilet compartment can be found in the section 12.2.

## 11.5 Toilet



- ▷ If there is any risk of frost and the vehicle is not heated, empty the sewage tank (cassette).
- ▷ Do not sit on the lid of the toilet. The lid is not designed to bear the weight of a person and could break.
- ▷ Use a suitable chemical for this toilet. The ventilation will merely remove the odour but not germs and gases. Germs and gases will have a detrimental effect on the sealing rubbers.
- ▷ Never put the sanitary liquid directly in the toilet bowl.



- ▷ Further information can be obtained in the device manufacturer's instruction manual.



- ▷ Only empty the sewage tank (cassette) at disposal stations, at camping sites or caravan sites, that are especially provided for this purpose.

The flushing of the toilet is fed directly from the water system of the vehicle.

### 11.5.1 Preparing toilet



- ▷ The sewage tank (cassette) can only be taken out if the sliding trap is closed.

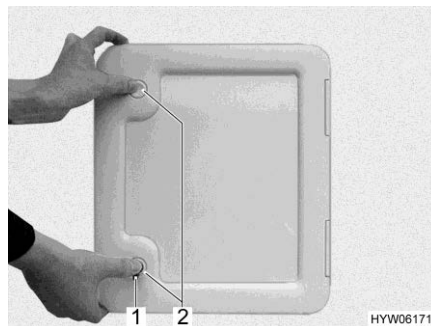

Fig. 266 Flap for sewage tank



Fig. 267 Flap for sewage tank (alternative)



Fig. 268 Flap for sewage tank (alternative)



Fig. 269 Sewage tank (example)

- Open the flap for the sewage tank on the outside of the vehicle. Insert the key into the locking cylinder of the push-button lock (Fig. 266,1, Fig. 267,1 or Fig. 268,1) and turn a quarter turn.
- Remove the key.
- If present: Press both push-button locks (Fig. 266,2 or Fig. 268,2) simultaneously with your thumb and open the flap.
- Pull up the retaining clip (Fig. 269,1) and lift the sewage tank (Fig. 269,2) straight up as far as it will go.
- Tilt the sewage tank slightly and remove fully.

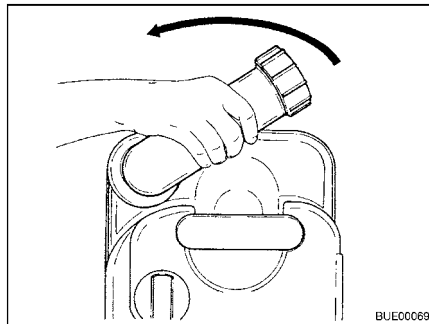

Fig. 270 Turning drainage neck

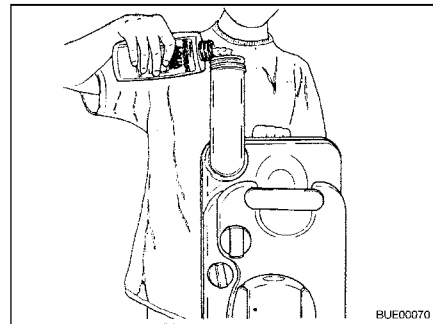

Fig. 271 Filling with sanitary liquid

- Put the sewage tank down vertically.
- Turn the drainage neck upwards (Fig. 270).
- Remove the cap of the drainage neck.
- Fill the stated amount of sanitary liquid into the sewage tank (Fig. 271).
- Then add enough water so that the bottom of the sewage tank is completely covered.
- Close drainage neck with the cap.
- Return the drainage neck to its original position.
- Push the sewage tank back to its original position without applying any force.
- Ensure that the sewage tank is secured by the retaining clip.
- Lock the flap for the sewage tank.

### 11.5.2 Swivel toilet

The flushing of the Thetford toilet is fed directly from the water system of the vehicle. The toilet bowl can be moved into the optimal position.

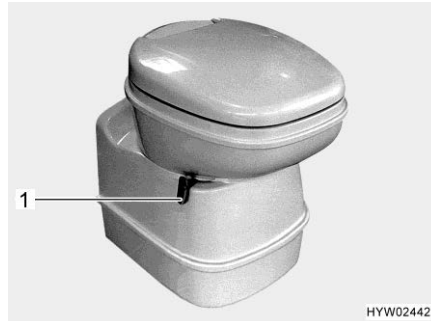

Fig. 272 Thetford toilet bowl, swivelling

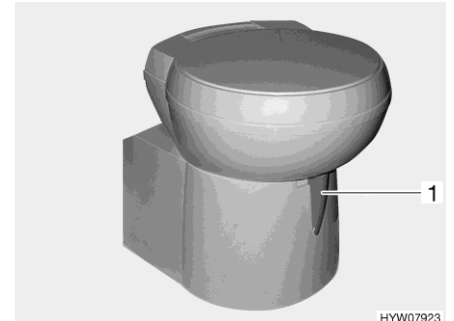

Fig. 273 Thetford toilet bowl, swivelling (alternative)

The operating unit is located close to the toilet bowl.

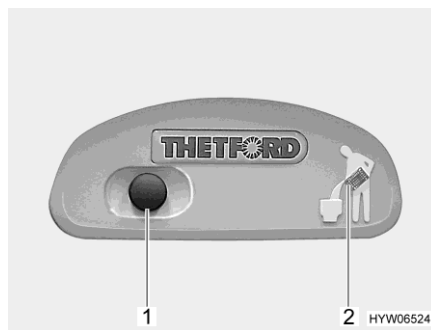

Fig. 274 Flush button/indicator lamp Thetford toilet



Fig. 275 Flush button/indicator lamp Thetford toilet (alternative)

- Flushing:**
- Before flushing open the sliding trap of the Thetford toilet. To do this, push the slide lever (Fig. 272,1 or Fig. 273,1) in an anticlockwise direction.
  - For flushing, press the blue flush button (Fig. 274,1 or Fig. 275,1).
  - After flushing close the sliding trap. To do this, push the slide lever in a clockwise direction.

The indicator lamp (Fig. 274,2 or Fig. 275,2) lights up whenever the sewage tank has to be emptied.

### 11.5.3 Toilet with fixed seat

The flushing of the toilet is fed from the water system of the vehicle.

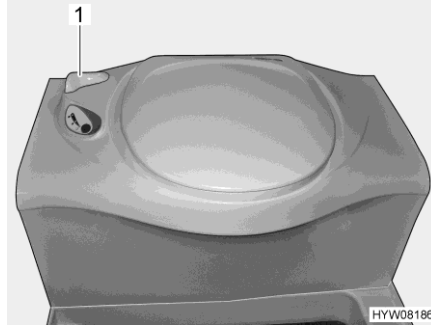

Fig. 276 Thetford toilet

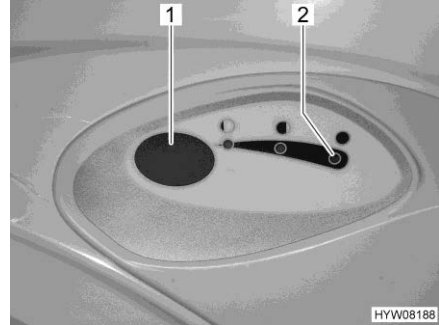

Fig. 277 Flush button/indicator lamp (Thetford toilet)

- Flushing:**
- Before flushing open the sliding trap of the Thetford toilet. To do this, turn the slide lever (Fig. 276,1) in an anticlockwise direction.
  - For flushing, press the blue flush button (Fig. 277,1).
  - After flushing close the sliding trap. To do this turn the slide lever (Fig. 276,1) in a clockwise direction.

The indicator lamp (Fig. 277,2) lights up whenever the sewage tank has to be emptied.



### 11.5.4 Emptying the sewage tank



▷ The sewage tank can only be taken out if the sliding trap is closed.

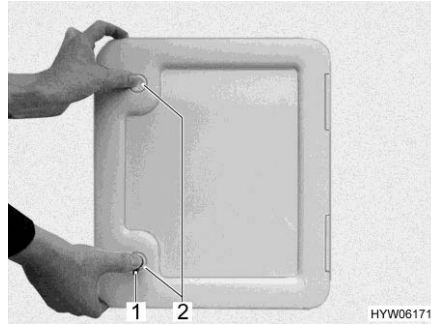

Fig. 278 Flap for the sewage tank



Fig. 279 Flap for the sewage tank (alternative)



Fig. 280 Flap for the sewage tank (alternative)



Fig. 281 Sewage tank (example)

- Slide the slide lever on the toilet bowl in a clockwise direction. The sliding trap is closed.
- Open the flap for the sewage tank on the outside of the vehicle. Insert the key into the locking cylinder of the push-button lock (Fig. 278,1, Fig. 279,1 or Fig. 280,1) and turn a quarter turn in a clockwise direction.
- Remove the key.
- Press both push-button locks (Fig. 279,2 or Fig. 280,2) simultaneously with your thumb and open the flap for the sewage tank.
- Pull the retaining clip (Fig. 281,1) upwards and pull out the sewage tank (Fig. 281,2).
- Completely empty the sewage tank at disposal stations that are especially provided for this purpose.



▷ Actuate the aeration knob on the sewage tank with your thumb to empty it completely.

### 11.5.5 Odour transformer for toilet compartment (optional equipment)

The toilet compartment can be equipped with an odour transformer.



Fig. 282 Odour transformer

Components of the odour transformer:

- Holder
- Clip-on attachment
- Tin with odourant



▷ Refill boxes with odourant can be obtained from the service partner.

## Chapter overview

This chapter contains instructions regarding the care of the vehicle.

At the end of the chapter there is a checklist of measures you must carry out if you are not going to use the vehicle for an extended period of time.

### 12.1 External care

Standard external care consists of regular washing. The use and the environmental conditions will determine how often the vehicle needs to be washed. Wash the vehicle more frequently in areas which are exposed to heavy air pollution or heavy traffic or roads treated with de-icing salts. If the vehicle is exposed to salty and humid air (coastal areas, humid climates), wash the vehicle more frequently.

Do not park under trees if at all possible. The resin-like discharge which many trees secrete, give the paintwork a matt look and can promote the onset of corrosion.

Wash off bird droppings straight away and thoroughly, as the acid it contains is extremely corrosive.

#### 12.1.1 Washing with a high-pressure cleaner



- ▷ Do not clean the tyres with a high-pressure cleaner. The tyres might be damaged.
- ▷ Do not spray external applications (deco-films) directly with the high-pressure cleaner. The external applications could come off.

Before cleaning the vehicle with a high-pressure cleaner, observe the operating manual of the high-pressure cleaner.

When cleaning with the nozzle for circular jet between the vehicle and the cleaning nozzle, maintain a minimum distance of approx. 700 mm.

Take into consideration that the jet of water comes out of the cleaning nozzle with pressure. The vehicle may be damaged by incorrect handling of the high-pressure cleaner. The temperature of the water should not be above 60 °C. Keep the jet of water in constant movement during the washing process. Do not direct the water jet at clearances, built-in electrical parts, plugs, seals, the ventilation grill or the skylights. The vehicle may be damaged or water may enter the interior.

### 12.1.2 Washing the vehicle



- ▷ Never clean the vehicle in the car wash. Water can penetrate the refrigerator grills, the waste gas vent or the forced ventilations. The vehicle could be damaged.
- Wash the vehicle only on a washing site intended for this purpose.
- Avoid full sunshine. Observe environmental measures.
- Only clean external applications and synthetic parts with plenty of warm water, dish washing liquid and soft cloth.
- Wash down the vehicle with plenty of water, a clean sponge or a soft brush. In the case of stubborn dirt add dish washing liquid to the water.
- Painted exterior walls may also be cleaned with a caravan cleaner.
- Add-on parts made of glass-fibre reinforced plastic (GRP) require a regular follow-up treatment with a polisher. This way these parts will not turn yellow and the sealing of the surface remains intact.
- Rub a conventional rubber care product onto the rubber seals on doors and storage flaps.
- Treat locking cylinder of doors and storage flaps with graphite dust.

### 12.1.3 Windows of acrylic glass

Acrylic glass windows are delicate and require very careful handling.



- ▷ Never rub acrylic glass windows dry as dust particles might damage the surface.
- ▷ Only clean acrylic glass windows with plenty of warm water, some dish washing liquid and a soft cloth.
- ▷ Never use glass cleaning agents with chemical, abrasive or alcohol-containing additives. Premature brittleness of the panes and associated cracks may result from their use.
- ▷ Avoid contact of cleansing agents used for the body (e.g. tar- or silicone-removing agents) with acrylic glass.
- ▷ Do not clean vehicle in car wash.
- ▷ Do not attach stickers to the acrylic glass windows.
- ▷ Having cleaned the vehicle rinse acrylic glass with sufficient clear water.
- ▷ Treat rubber seals with a conventional rubber care product.



- ▷ An acrylic glass cleanser with antistatic effect is suitable for a follow-up treatment. Small scratches can be treated with an acrylic glass polish. These agents are available at the accessories shop.

### 12.1.4 Entrance step

If the entrance step is lubricated, coarse particles of dirt can settle on the lubricant during the journey and cause damage to the operating mechanism of the entrance step. Therefore, do not lubricate the moving parts of the entrance step.

## 12.2 Interior care



- ▷ If possible, treat stains immediately.
- ▷ Acrylic glass windows are delicate and require very careful handling (see section 12.1.3).
- ▷ Synthetic parts in the toilet and living area are very delicate and should be treated with care. Do not use solvents, alcohol-containing cleansers or scourers. This procedure will help you to avoid brittleness and formation of cracks.
- ▷ Hair colourants, nail varnish, cigarette ash and similar substances may cause permanent stains or discolouration. For this reason, you should prevent these substances from getting onto plastic parts. If they do get onto plastic parts, you should remove these substances immediately.
- ▷ Do not pour any corrosive agents into the drain holes. Never pour boiling water directly into the drain holes. Corrosive agents and boiling water cause damage to drainage pipes and siphon traps.
- ▷ Do not use vinegar based products to clean the toilet and water system, or for descaling the water system. Vinegar-based products may cause damage to seals or parts of the installation. Use standard descaling products for descaling.
- ▷ Save water. Mop up all remaining water.
- ▷ Vacuum off carpets and cushions with a suitable brush attachment.



- ▷ For information about the use of maintenance products, our representatives and service centres will be glad to advise.
- Surface and knobs of furniture, lamps and synthetic parts in the toilet and living area should be cleaned with water and a wool cloth. A mild cleanser may be added to the water. If required, use furniture polish for the painted surfaces.
- Clean upholstery with dry foam specially manufactured for the use on upholstery or with the foam of a mild detergent. Do not wash upholstery. Always have it cleaned. Protect cushions from direct sunlight so that they do not lose their colour.
- Leather covers should be cleaned with a cotton cloth and a mild soap (curd soap). Make sure that the leather is not soaked through and that no water seeps through the seams of the leather covers.
- Wash panel curtains and gathered blinds. When washing observe washing instructions on the product. The sticks may be removed for washing.
- Vacuum clean the carpet, if necessary clean with carpet shampoo.
- Clean PVC-floor covering with a mild, soapy cleaning agent for PVC floors. Do not place carpet on wet PVC-floor covering. The carpet and the PVC-floor covering may stick together.
- Clean the sink cover manually using water and washing-up liquid. Do not clean the sink cover in the dishwasher.
- Never clean the sink or the gas cooker with a scourer. Avoid anything which may cause scratching or grooves.

- Clean the burners on the gas cooker using a damp cloth only. Prevent any water from penetrating the burner covers. Water may damage the burners on the gas cooker.
- Brush insect screens on doors, windows and skylights with a soft brush or vacuum with the brush attachment of the vacuum cleaner.
- Brush blinds with a soft brush or vacuum with the brush attachment of the vacuum cleaner. Grease or stubborn dirt may be removed with a mild soap at 30 °C (curd soap).
- Brush Roman shades with a soft brush or vacuum with the brush attachment of the vacuum cleaner. Grease or stubborn dirt may be removed with a mild soap at 30 °C (curd soap).
- Unrolled seat belts can be cleaned with warm soapsuds. The seat belt must be completely dry before being rolled up.

### 12.2.1 Scratch-resistant surface (kitchen worktop and table top) (optional equipment)



- ▷ Do not use any cleaning agents with abrasives.
  - ▷ Do not use any sponges with abrasive material.
  - ▷ Do not use any steel wool.
  - ▷ Do not use any cleaning agents with high acid content.
  - ▷ Do not use any furniture polish nor any cleaning agent based on wax.
- Wipe the surface with a damp cloth.
  - In the case of heavy soiling, wipe the surface with an of-the-shelf cleaner, glass cleaner, dirt eraser, or disinfectant.
  - Remove adhesive, dried up bio-waste, chewing gum with sponge, hot water, and household cleaner.
  - Remove hairspray, cooking oil, wax, ball pen ink, make-up, nail varnish, marker pens (Edding) with a cloth moistened with alcohol or acetone.
  - Remove oil paints with a cloth moistened with paint thinner.
  - For descaling use a cleaning agent that contains no more than 10 % acetic or citric acid.
  - Remove minor scratches with a dirt eraser.
  - Cover deeper scratches with moist kitchen paper. Using an iron set to level II, iron the scratcher in circular motion for no more than 20 seconds. Using a lint-free cloth, rub the scratch in circular motion.

## 12.3 Water system

### 12.3.1 Cleaning the water tank

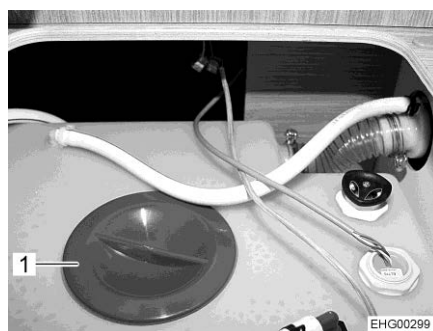

Fig. 283 Cleaning opening of the water tank



Fig. 284 Cleaning opening of the water tank (service unit)

- Empty the water tank and close the drainage opening.
- Remove the cap (Fig. 283,1 or Fig. 284,1) of the water tank.
- Fill water tank with water and some washing-up liquid (do not use any scourers).
- Using a trade standard brush for washing dishes, scrub the water tank until there is no longer any visible deposit.
- If possible, clean fresh water sensors through the cleaning openings by hand.
- Rinse water tank with copious amounts of drinking water.



- ▷ If, due to the design of the water tank, it is not possible to clean the water tank mechanically: Use a suitable chemical cleaning agent. The authorised dealers would be happy to assist you in choosing a suitable cleaning agent. Follow the cleaning agent manufacturer's instructions.

### 12.3.2 Cleaning the water pipes



- ▷ Only use approved cleaning agent as sold by the specialist trade.  
 ▷ The cleaning agent must meet national regulations and be approved (if required).



- ▷ Collect any emerging mixture of water and cleaning agent for correct disposal.

- Empty the water system.
- Close all drainage openings and drain cocks.
- Fill mixture of water and cleaning agent into the water tank. Observe the manufacturer's instructions regarding the mixing ratio.
- Open the drain cocks one by one.
- Leave the drain cocks open until the mixture of water and cleaning agent has reached the respective drain.

- Close the drain cocks.
- Set all the water taps to Hot and open them.
- Leave the water taps open until the mixture of water and cleaning agent has reached the drain.
- Set all water taps to Cold and open them.
- Leave the water taps open until the mixture of water and cleaning agent has reached the drain.
- Close all water taps.
- Flush the toilet several times.
- Allow the cleaning agent to act in accordance with the manufacturer's instructions.
- Empty the water system. Collect the mixture of water and cleaning agent for correct disposal.
- For rinsing fill the entire water system with drinking water and empty again several times over.

### 12.3.3 Disinfecting the water system



- ▷ Only use approved disinfectants as sold by the specialist trade. Observe the tolerance of humans and animals.
- ▷ The disinfectant must meet national regulations and be approved (if required).



- ▷ Collect any emerging mixture of water and disinfectant for correct disposal.

When disinfecting the water system, proceed the same way as when cleaning the water pipes (see section 12.3.2). Simply use disinfectant instead of cleaning agent.



### 12.3.4 Cleaning the waste water tank

Clean the waste water tank after every use.

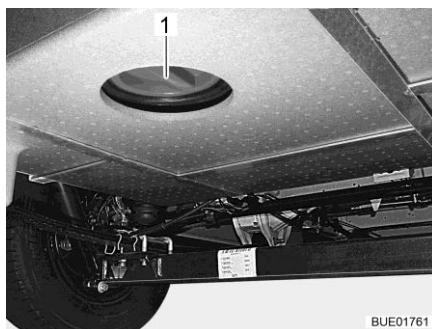

Fig. 285 Cleaning opening (waste water tank)

- Empty the waste water tank.
- Open the cleaning opening (Fig. 285,1) on the waste water tank and the drain cock.
- Thoroughly rinse out the waste water tank with fresh water.
- If possible, clean waste water sensors through the cleaning opening by hand.

## 12.4 Extractor hood

A metal grease filter is installed in the extractor hood which must be cleaned occasionally. How often cleaning is necessary depends on how often the extractor hood is used. Do not wait to clean the filter until the performance of the extractor hood has noticeably decreased.

Cleaning the metal grease filter:

- Wash the metal grease filter with warm water and some washing-up liquid.
- Leave the metal grease filter to air dry.

In the recirculating extractor hood, there is an active carbon filter installed additionally. Replace the active carbon filter if necessary (see section 13.6).

## 12.5 Air conditioning unit Telair

Every now and then clean the filter and the ventilation grilles on the outside of the housing. How often cleaning is necessary depends on how often the air conditioning unit is used. Do not wait to clean the filter and the ventilation grill until the performance of the air conditioning unit has noticeably decreased.



- ▷ Only use mild cleaning solutions to clean the filter, never use benzene or solvents.

Cleaning the filter:

- Wash the filter with warm water and some washing-up liquid.
- Allow the filter to dry thoroughly before reassembly.

Cleaning the ventilation grill:

- Use a brush to remove coarse dirt or deposits from the external ventilation grilles. If a cleaning solution is used, ensure that no water ingresses into the inside of the housing.

## 12.6 Winter care

De-icing salt damages the underbody and the parts open to water spray. We recommend that you wash the vehicle more frequently during wintertime. Mechanical and surface treated parts and the underside are under particular strain, and should therefore be cleaned thoroughly.



- ▷ If there is any risk of frost, always run heater at a minimum of 15 °C. Switch the circulation fan (if there is one) to automatic. In the case of extreme external temperatures, the furniture flaps and doors should be left slightly open. The inflowing warm air can help prevent the freezing of water pipes, for example, and counteract the formation of condensation in the storage spaces.
- ▷ If there is any risk of frost, cover the outside surface of the windows with winter insulation mats.
- ▷ Keep waste gas vents and forced ventilations free of snow. Use a vent extension, if necessary.

### 12.6.1 Preparations

- Check the vehicle for paint and rust damage. Repair damage as necessary.
- Make certain that water cannot penetrate the automatic floor ventilation system and the heater.
- Use a wax-based rust inhibitor to protect the metal parts of the underbody.
- Use appropriate protection for external painted surfaces.

## 12.6.2 Winter operation

During winter operation, condensation develops when the vehicle is occupied under low-temperature conditions. To ensure good interior air quality and avoid vehicle damage from condensation, sufficient ventilation is essential.

- When heating the vehicle, the heater should be at the highest setting and roof storage cabinets, curtains and blinds should be opened. This ensures optimal ventilation.
- Only heat if the circulation system is switched on.
- In the morning, lift up all cushions, air out storage boxes and dry any damp areas.



- ▷ If condensation has still developed, just wipe it off.
- ▷ It is only possible to guarantee unrestricted operation during winter for models without double floor in connection with the "winter package" from the original equipment.

## 12.6.3 At the end of the winter season

- Thoroughly clean the underbody of the vehicle and the engine. When this is done, corrosion-inducing anti-freeze agents (salts, alkaline residues) are removed.
- Clean the exterior and use regular car wax to protect metal surfaces.



## 12.7 Lay-up

### 12.7.1 Temporary lay-up



- ▶ If the vehicle has been stationary for a long period (approx. 10 months) have the braking and gas systems checked by an authorised specialist workshop.
- ▶ Take into consideration that water is undrinkable after only a short time.
- ▶ Animal damage to cables can lead to short circuits. Fire hazard!

Go through the following checklist before a lay-up:

	Activity	Done
<b>Base vehicle</b>	Completely fill fuel tank. This prevents corrosion damage within the fuel tank system	
	Jack up vehicle so that the wheels do not bear any load, or move vehicle every 4 weeks. This prevents any pressure points from occurring on tyres and wheel bearings	
	Protect the tyres from direct exposure to the sun. Danger of formation of cracks!	
	Inflate tyres up to the recommended maximum pressure	
	Always provide for sufficient ventilation in the underbody area  ▷ Humidity or lack of oxygen e.g. by covering with plastic film may cause optical irregularities to the underbody.	
	In addition observe the notes in the operating manual of the base vehicle	
<b>Body</b>	All vents should be sealed with the appropriate caps and all other openings (apart from forced ventilations) should also be sealed. This prevents animals (e.g. mice) from gaining entry	
	Air the interior, all storage spaces accessible from the outside, and the parking space (e.g. garage) every 3 weeks in order to prevent the occurrence of condensation and resulting mould formation	
<b>Interior</b>	Place upholstery in an upright position for ventilation, and cover	
	Clean refrigerator	
	Allow refrigerator and freezer compartment doors to remain slightly open	
	Search for traces of animals that have gained entry	
	Disconnect the flat screen from the mains and, if necessary, remove it from the vehicle	
<b>Gas system</b>	Close regulator tap on the gas bottle	
	Close all gas isolator taps	
	Always remove gas bottles from the gas bottle compartment, even if they are empty	
<b>Electrical system</b>	Fully charge living area and starter battery  ▷ Charge the battery for at least 20 hours before laying up.	
	Disconnect the living area battery from the 12 V power supply. To do this, switch off the battery cut-off switch on the transformer/rectifier (see chapter 9)	
<b>Water system</b>	Empty the entire water system. Blow out the residual water from the water pipes (0.5 bar max.). Leave the water taps on in central position. Leave all drain cocks open. Observe the notes in chapter 11	

## 12.7.2 Lay-up over winter

Additional measures are required if laying up the vehicle over winter:

	Activity	Done
<b>Base vehicle</b>	Clean body and underbody thoroughly and spray with hot wax or protect with varnish	
	Fill fuel tank with winter diesel	
	Check antifreeze in the cooling water	
	Rectify damage to the paintwork	
	Fill in windscreen washer fluid with frost protection	
<b>Body</b>	Clean vehicle from outside thoroughly	
	Keep the forced ventilation open	
	Clean and grease installed supports	
	Clean and grease all door and flap hinges	
	Brush oil or glycerine on all locking mechanisms	
	Treat all rubber seals with a conventional rubber care product	
	Use graphite dust to treat locking cylinders	
<b>Interior</b>	Set up the de-humidifier (granulate)	
	Remove cushions and mattresses from the vehicle and store them in a dry place	
	Air the interior every 3 weeks	
	Empty all cabinets and storage compartments, open flaps, doors and drawers	
	Thoroughly clean the interior	
	If there is a risk of frost, do not leave the flat screen in the vehicle	
<b>Electrical system</b>	Remove the starter battery and the living area battery and store them in a place protected from frost (see chapter 9) or connect the vehicle to a 230 V supply. Before removing, remove the fuses on the living area battery	
<b>Water system</b>	Clean the water system using approved cleaning agents from a specialised store	
<b>Complete vehicle</b>	Arrange the tarpaulins in such a way that the ventilation openings are not covered, or use porous tarpaulins	

### 12.7.3 Starting up the vehicle after a temporary lay-up or after lay-up over winter

Go through the following checklist before start-up:

	Activity	Done
<b>Base vehicle</b>	Check the tyre pressure on all tyres	
	Check the tyre pressure of the spare wheel (if present)	
<b>Body</b>	Clean the pivot bearing of the entrance step	
	Check the functioning of the fitted supports	
	Check that the doors, windows and skylights are working properly	
	Check that all the external locks are working, such as the storage flaps, the filler neck and the conversion door	
	Search for traces of animals that have gained entry	
	Remove the cover from the waste gas vent of the heater (if there is one)	
	Remove the winter cover from the refrigerator grills (if there is one)	
<b>Gas system</b>	Put the gas bottles in the gas bottle compartment, tie down and connect to the gas pressure regulator	
<b>Electrical system</b>	Connect to 230 V external power supply	
	Install the living area battery and starter battery, insert the fuses on the living area battery and fully charge the battery  ▷ Charge the battery for at least 20 hours after lay-up.	
	Connect the living area battery with the 12 V power supply. To do this, switch on the battery cut-off switch on the transformer/rectifier (see chapter 9)	
	Check that the electrical system are working, e.g. interior light, socket and all installed electrical appliances	
<b>Water system</b>	Disinfect water pipes and water tank	
	Check the functionality of the operating lever for the waste water tank	
	Close all drain cocks and water taps	
	Check water system for leaks	
<b>Appliances</b>	Check the function of the appliances	

## Chapter overview

This chapter contains instructions about official inspections and inspection and maintenance work in the vehicle.

At the end of the chapter you will find important instructions on how to obtain spare parts.

### 13.1 Official inspections

Depending on the national legislative provisions, the following official inspections must be carried out periodically:

- Main inspection
- Emissions test
- Inspection of the gas system

The inspection intervals in accordance with the national legislative provisions must be adhered to. The inspection stickers attached to the vehicle indicate when the next inspection is required.

For Germany, for example, the following regulation applies:

From April 1st 2022, the inspection obligation for the gas system as part of the main inspection (HU) will no longer apply. Instead, an independent gas inspection (according to DVGW (German Technical and Scientific Association for Gas and Water) worksheet G 607) must be carried out for recreational vehicles (motorhomes and caravans). The gas inspection is evidenced by the correctly completed yellow inspection book and a valid inspection sticker on the vehicle.

For more information on the gas inspection and the intervals at which it must be carried out, see the following websites:

- German Federal Ministry of Digital Affairs and Transport (BMDV): [www.bmvi.de](http://www.bmvi.de)
- German Technical and Scientific Association for Gas and Water (DVGW): [www.dvgw.de](http://www.dvgw.de)
- German Association for Liquefied Gas (DVFG): [www.dvfg.de](http://www.dvfg.de)

As long as the intervals at which the gas inspection must be carried out are not regulated by law, the DVGW recommends an inspection every two years.

Many camping site operators demand proof of a valid gas inspection when allocating a parking place.



- ▷ Any changes on the gas system must be carried out by a certified expert for gas systems.
- ▷ Even in the case of vehicles that are not registered, an inspection of the gas system is required.

## 13.2 Inspection work

Like any technical appliance, the vehicle must be inspected at regular intervals.

This inspection work must be carried out by qualified personnel.

Special technical knowledge, which cannot be taught within the framework of this instruction manual, is required for these tasks. Personnel possessing this technical knowledge are available for assistance at all our service centres. Their experience and regular technical instruction by the factory as well as equipment and tools guarantee expert and up-to-date inspection of the vehicle.

Have the "First Programmed Inspection" carried out at one of our service centres 12 months after initial registration.

Further inspections should be carried out once a year.

The service centre in charge will confirm the work performed.

Have chassis inspections confirmed in the chassis manufacturer's customer service booklet.



- ▷ Observe the inspections indicated by the manufacturer and have them carried out at the specified intervals. The value of the vehicle is thus preserved.
- ▷ The confirmation of the inspection work carried out serves as valid proof in the event of damage and guarantee claims.

## 13.3 Maintenance work

As with every machine, this vehicle requires maintenance. The extent and frequency of the maintenance work required depend on conditions of operation and use. More difficult operating conditions make it necessary to service the vehicle more often.

Have the base vehicle and the appliances serviced at the intervals specified in the corresponding instruction manuals.

## 13.4 Doors

To maintain gliding capability between springs and hinges, grease the conversion door hinges occasionally.



- ▷ We recommend either Molykote PG 65 or Vaseline as lubricants.



### 13.5 Living area battery

Observe the following to extend battery life:

- Keep the battery surface clean and dry.
- Protect the battery poles and the terminals from corrosion.
- Check the charging condition periodically or use a charge conservation device.
- Always keep stored batteries in charged condition and in a cool place.

### 13.6 Extractor hood

The active carbon filter in the recirculating extractor hood must be replaced with a conventional active carbon filter if necessary.

- Remove the metal grease filter and clean if necessary.
- Remove the active carbon filter.
- Shake the new active carbon filter if necessary, such that the carbon granules are evenly distributed.
- Insert a new active carbon filter.
- Insert the metal grease filter.

### 13.7 Alde hot-water heater



- ▷ Check the level of the heating fluid regularly on the compensator reservoir.
- ▷ During or after the first operating hours of the hot-water heater, the filling level may fall below the minimum mark. If this is the case, top up the heating fluid.
- ▷ We recommend to bleed the heating system after the initial heater operation and to check the glycol content.
- ▷ Have heating fluid changed by an authorised dealer or a service centre at intervals of five years as corrosion-protection wears off after some time.
- ▷ Only top up heating system with a standard G13 water-glycol mixture (60 : 40). This mixture offers frost protection up to approx. -25 °C. When topping up hot-water heaters that are connected to the engine's cooling circuit, please observe the instructions in the manufacturers' instruction manuals.



- ▷ Further information can be obtained in the manufacturer's instruction manual.

### 13.7.1 Checking the fluid level

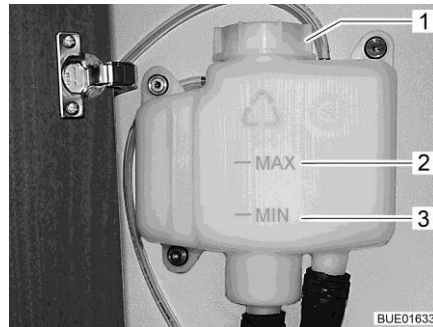

Fig. 286 Compensator reservoir without panel

- Switch off the hot-water heater and allow it to cool down.
- Check if the fluid level is between the marks "MIN" (Fig. 286,3) and "MAX" (Fig. 286,2) on the compensator reservoir (Fig. 286).

### 13.7.2 Topping up heating fluid

- Position the vehicle horizontally. This prevents the formation of bubbles.
- Switch off the hot-water heater and allow it to cool down.
- If necessary, unscrew or remove the panel (depending on the model).
- Open the rotary lid (Fig. 286,1) on the compensator reservoir.
- Remove cover.
- Check anti-freeze with an anti-freeze hydrometer. The frost protection content must be 40 % or correspond to a frost protection of -25 °C.
- Fill water frost protection mixture slowly into the compensator reservoir.



- ▷ The optimum fluid level is reached when the fluid in the compensator reservoir is 1 cm above the "MIN" mark when it is cooled down.

### 13.7.3 Bleeding the heating system



Fig. 287 Bleeding valve of hot-water heater

The bleeding valves are built in nearby the radiators.

- Switch off the hot-water heater and allow it to cool down.
- Open bleeding valve (Fig. 287,1) and leave open until no more air escapes.
- Close bleeding valve.
- Repeat this procedure at all bleeding valves.
- Check to see if the hot-water heater warms up.

### 13.8 Replacing bulbs, external



- ▶ Bulbs and lamp holders can be extremely hot. Therefore, allow lamps to cool down before changing bulbs.
- ▶ Store bulbs in a safe place inaccessible to children.
- ▶ Do not use any bulb that has been dropped or which shows scratches in its glass. The bulb might burst.



- ▷ Do not touch a new bulb with bare fingers. Use a cloth when installing the new bulb.
- ▷ Only use bulbs of the same type and with the correct wattage.
- ▷ If LEDs in lamps are defective, contact an authorised dealer or service centre.

**Types of bulbs** Different types of bulbs are used in the vehicle. Below, we have described how to change the different types of bulbs.

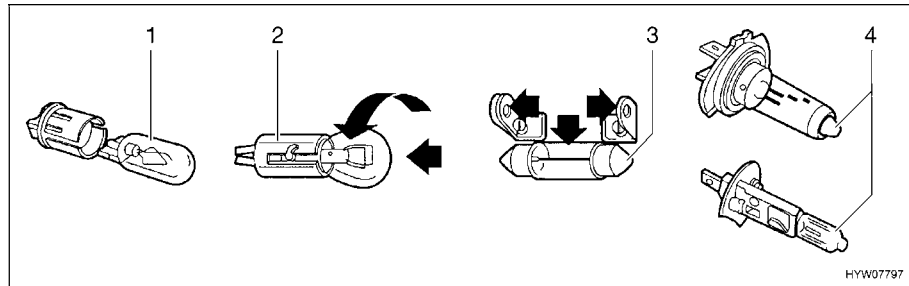

Fig. 288 Types of bulbs

Pos. in Fig. 288	Fixture type/bulb type	Changing
1	Plug-in fixture	To remove, pull out the bulb
		To mount, push the bulb into the socket with gentle pressure
2	Bayonet socket	To remove, press the bulb down and turn in an anticlockwise direction
		To insert, place the bulb in the socket and turn in a clockwise direction
3	Cylindrical bulbs	To remove and to insert, carefully bend the contacts of the lamp holder outwards
4	Halogen bulb	To remove, release retaining springs
		After inserting, hook the retaining springs again

### 13.8.1 Front lights

The lamps for low beam, main beam and parking light as well as for the direction indicator are part of the base vehicle. Replacement of light bulbs is described in the instruction manual of the base vehicle.

### 13.8.2 Rear lights (variant 1)

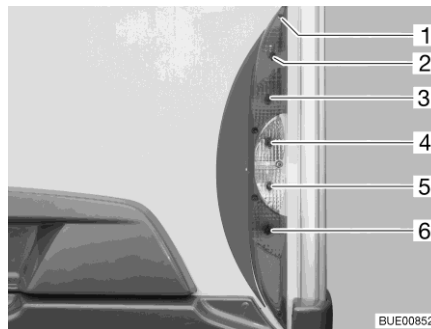

- 1 Housing screws
- 2 Rear light
- 3 Brake light
- 4 Direction indicator
- 5 Reverse light
- 6 Fog tail light

Fig. 289 Rear lights

- Undo the five housing screws (Fig. 289,1).
- Remove the housing.
- Remove bulb.
- Put in a new bulb.
- Reassemble the lamp in the reverse order.

### 13.8.3 Rear lights (variant 2)

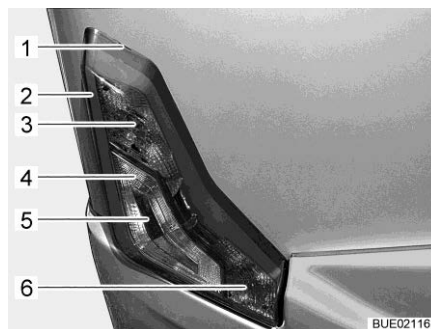

Fig. 290 Rear lights

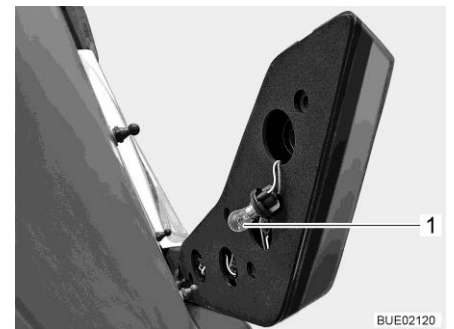

Fig. 291 Rear light

- 1 Notch
- 2 Rear light
- 3 Brake light
- 4 Reverse light
- 5 Direction indicator
- 6 Fog tail light

- Insert flat tool into notch (Fig. 290,1) and carefully lever off the housing.
- Reach into the hole on the back of the housing. Turn and pull holder (Fig. 291,1) out (bayonet fitting). The figure shows the brake light as an example.
- Remove bulb.
- Put in a new bulb.
- Insert holder into the hole and turn it until it has been fixed.
- Align housing with the conic pin and press it against the vehicle's rear.

The rear lights are equipped with LEDs. To change the LEDs, contact an authorised dealer or a service centre.

### 13.8.4 Side lights

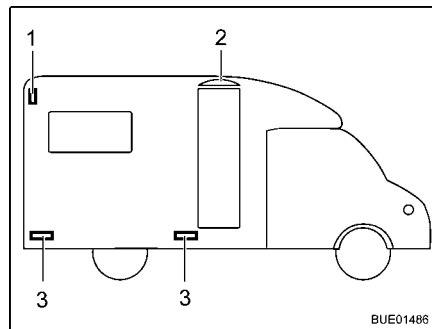

- 1 Side marker light
- 2 Awning light
- 3 Marker light

Fig. 292 Side lights

**Side marker light** The side marker light (Fig. 292,1) is located at the top of the side wall area at the back of the vehicle.

**Marker lights** The marker lights (Fig. 292,3) are fitted in the lower part of the vehicle.

**Awning light** The awning light (Fig. 292,2) is located above the conversion door.



- ▷ The lights have LEDs. To change the LEDs, contact an authorised dealer or a service centre.

### 13.8.5 Types of bulbs for exterior lighting

	Exterior lighting	Type of bulb
<b>Rear</b>	Brake light	Ba15s 12 V 21 W
	Rear light (variant 1)	Ba15s 12 V 5 W
	Rear light (variant 2)	LED 3.2 W
	Direction indicator	Ba15s 12 V 21 W orange
	Fog tail light	Ba15s 12 V 21 W
	Licence plate light	Soffitte 12 V 5 W
	Reverse light	Ba15s 12 V 21 W
	Third brake light	LED
<b>Side</b>	Side marker light	LED
	Awning light	LED
	Marker light	LED

## 13.9 Replacing bulbs, internal



- ▶ Bulbs and lamp holders can be extremely hot. Therefore, allow lamps to cool down before changing bulbs.
- ▶ Shut off the power supply on the safety cut-out in the 230 V fuse box before changing bulbs.
- ▶ Store bulbs in a safe place inaccessible to children.
- ▶ Do not use any bulb that has been dropped or which shows scratches in its glass. The bulb might burst.
- ▶ Halogen lamps can get very hot. When the light is switched on, there must always be a safety distance of 30 cm between light and flammable objects. Fire hazard!
- ▶ Do not replace the LEDs in lamps with standard light bulbs. Risk of fire due to intense heat build up.



- ▷ A new bulb should not be touched with the fingers. Use a cloth when installing the new bulb.
- ▷ Only use bulbs of the same type and with the correct wattage.
- ▷ If LEDs in lamps are defective, contact an authorised dealer or service centre.

### 13.9.1 Ceiling lamp

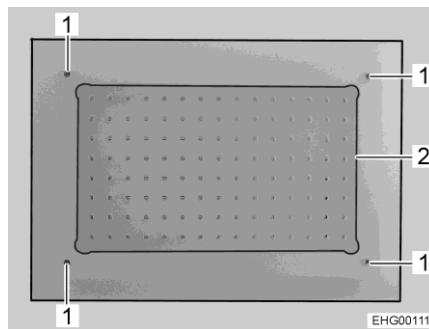

Fig. 293 Ceiling lamp

- Unscrew 4 screws (Fig. 293,1).
- Remove glass plate (Fig. 293,2) with firmly mounted LEDs.
- Position new glass plate including LEDs and screw in the 4 screws (Fig. 293,1).

### 13.9.2 Surface mounted light

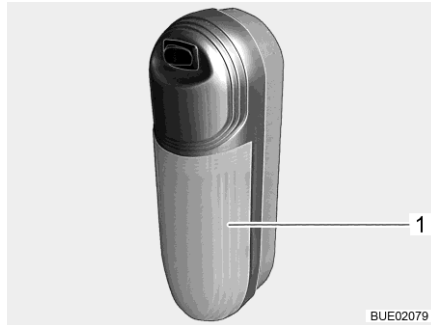

Fig. 294 Surface mounted light

Halogen bulb 12 V/16 W

- Changing bulbs:
- Pull transparent cover (Fig. 294,1) slightly away from switch and remove it.
  - Remove halogen bulb.
  - Put in a new halogen bulb.
  - Reassemble the lamp in the reverse order.

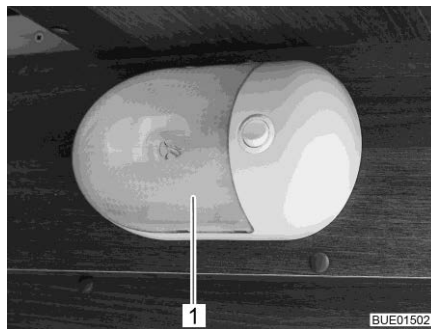

Fig. 295 Surface mounted light

Halogen bulb 12 V/16 W

- Changing bulbs:
- Carefully push the transparent cover (Fig. 295,1) together from both sides, pull it lightly from the switch and pull it off forwards.
  - Remove halogen bulb.
  - Put in a new halogen bulb.
  - Reassemble the lamp in the reverse order.



### 13.10 Spare parts



- ▶ Every alteration of the original condition of the vehicle can alter road behaviour and jeopardize road safety.
- ▶ The optional equipment and original spare parts recommended by us have been specially developed and supplied for your vehicle. These products are available at the authorised dealer or service centre. The authorised dealer or service centre is informed about admissible technical details and carries out the required work correctly.
- ▶ The use of accessories, parts and fittings not supplied by us may cause damage to the vehicle and jeopardize road safety. Even if an expert's report, a general type approval or a design certification exists, there is no guarantee for the proper quality of the product.
- ▶ No liability can be assumed for damage caused by products which have not been released by us. This also applies to impermissible alterations to the vehicle.

For safety reasons, spare parts for pieces of equipment must correspond with manufacturer's instructions and be permitted by the manufacturer as a spare part. These spare parts may only be fitted by the manufacturer or an authorised specialist workshop. The authorised dealers and service centres are available for any spare parts requirement.

Here are some suggestions of important spare parts:

- Fuses
- V-belt
- Windscreen blades
- Bulbs
- Water pump (submerged pump)

When ordering spare parts please indicate the chassis number and the vehicle type to the dealer.

The vehicle described in this instruction manual is built and equipped to factory standards. Optional equipment is offered depending on its purpose or use. When fitting optional equipment check if such equipment has to be entered in the vehicle documents. Observe the technically permissible maximum laden mass. The authorised dealer or service centre will be happy to advise you.

### 13.11 Vehicle identification plate

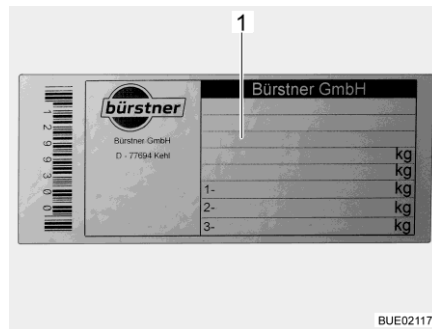

1 Chassis number

Fig. 296 Vehicle identification plate

The vehicle identification plate (Fig. 296) with the chassis number is attached inside, to the B pillar.

Do not remove the vehicle identification plate. The vehicle identification plate:

- Identifies the vehicle
- Helps with the procurement of spare parts
- Together with the vehicle documents identifies the vehicle owner



- ▷ Always include the **chassis number** with all inquiries for the customer service office.

### 13.12 Warning and information stickers

There are warning and information stickers on and inside the vehicle. Warning and information stickers are for the sake of safety and must not be removed.



- ▷ Replacement stickers can be obtained from an authorised dealer or a service centre.

## Chapter overview

This chapter contains instructions regarding the tyres of the vehicle.

At the end of the chapter there is a table you can use to find the correct tyre pressure for your vehicle.

### 14.1 General



- ▶ Check tyre pressure before a journey or every 2 weeks. Wrong tyre pressure causes excessive wear and can lead to damage or even to tyre burst. You can lose control of the vehicle (see section 14.6).



- ▷ Check the tyre pressure on cold tyres. Do not reduce the higher tyre pressure when the tyres are warm.
- ▷ Tubeless tyres have been installed on the vehicle. Never install tubes in these tyres.
- ▷ Read the instruction manual for the base vehicle.



- ▷ Depending on the model, the vehicle may only be equipped with a tyre repair kit as standard.
- ▷ In the case of a puncture, pull the vehicle over to the side of the road. Make vehicle safe with a hazard warning triangle. Switch on the warning lights.
- ▷ Tyres on vehicles with tandem axles may wear faster.
- ▷ Tyres should not be older than 6 years because the material will become brittle over time. Have the tyres inspected after 6 years. The four-digit DOT number on the tyre flank indicates the date of manufacture. The first two digits designate the week, the last two digits the year of manufacture.

Example: **0723** Week 07, year of manufacture 2023

- Observe:**
- Check the tyres regularly (every 2 weeks) for equal tread wear, tread depth and external damage.
  - Replace tyres at the latest, when the minimum depth of tread stipulated by law is reached.
  - We recommend always using tyres of the same model, same brand and same version (summer and winter tyres).
  - Only use tyres approved for the wheel rim type fitted. The permitted rim and tyre sizes are quoted in the vehicle documents and the authorised dealer or service centre will always be glad to give you advice.
  - Run-in new tyres for approx. 100 km (60 miles) at low speed since only then do they reach full strength.

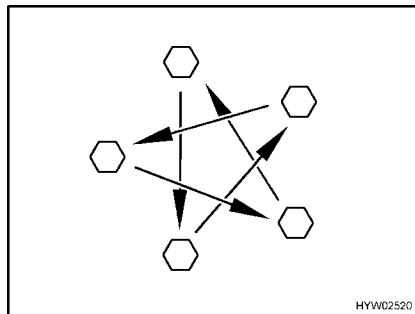

Fig. 297 Tighten the wheel nuts or wheel bolts cross-wise

- Check regularly that the wheel nuts or wheel bolts are firmly seated. Re-tighten the wheel nuts or wheel bolts of a changed wheel after 50 km (30 miles) (Fig. 297).  
For tightening torque see section 14.5.2.
- When using new or newly painted rims, re-tighten the wheel nuts or wheel bolts once again after approx. 1,000 to 5,000 km (600 miles to 3,000 miles) (Fig. 297).
- For lay-ups or long periods of inactivity of the vehicle, keep the tyres and tyre bearings free from pressure points: Jack up the vehicle so that the wheels do not bear any load, or move the vehicle every 4 weeks in such a way that the position of the wheels is changed.

## 14.2 Tyre selection



- ▶ A wrong tyre can damage the tyres during the journey and even cause it to burst.



- ▷ If tyres that are not approved for the vehicle are used, then the type approval for the vehicle and subsequently the insurance coverage can lapse. The authorised dealer or service centre will be happy to advise you.

The tyre sizes approved for the vehicle are given in the vehicle documents or can be obtained from the authorised dealers or service centres. Each tyre must fit the vehicle on which it will be driven. This applies to the external dimensions (diameter, width), which are indicated with the standardised size designations. In addition, the tyres must meet the requirements of the vehicle with regard to weight and speed.

The weight is based on the technically permissible maximum laden mass on the axle, which is distributed between two tyres. The maximum load-carrying capacity of a tyre is indicated by its load index (= LI, load index code).

The maximum permissible speed for a tyre (with full load-carrying capacity) is indicated by the speed index (= SI). Together, load index and speed index form the operating code of a tyre. This is an official component of the complete, standardised dimensions description which appears on every tyre. The information on the tyres must correspond to the specifications which appear in the vehicle papers.

### 14.3 Tyre specifications

215/70 R 15C  
109/107 Q (example)

Description	Explanation
215	Tyre width in mm
70	Height-to-width proportion in percent
R	Tyre design (R = radial)
15	Rim diameter in inches
C	Commercial (transporter)
109	Load index code for single tyres
107	Load index code for twin tyres
Q	Speed index (Q = 160 km/h)

### 14.4 Handling of tyres

- Drive over kerbs at an obtuse angle. Otherwise the flanks of the tyres may get pinched. Driving over a kerb at a sharp angle can damage the tyre and result in it getting ruptured.
- Drive over high manhole covers at a slow speed. Otherwise the tyres may get pinched. Driving over a high manhole cover at high speed can damage the tyre and result in it getting ruptured.
- Check the shock absorbers regularly. Driving with poor shock absorbers significantly increases wear.
- In the event of an uneven thread wear, contact customer service.
- Do not clean the tyres with a high-pressure cleaner. The tyres can suffer serious damage within just a few seconds and rupture as a result.

### 14.5 Changing wheels

#### 14.5.1 General instructions



- ▶ The vehicle must be on level, firm ground, secure from slipping.
- ▶ Go into first gear. In the case of automatic transmission, change gear to "P" position.
- ▶ Before jacking up the vehicle firmly apply the handbrake.
- ▶ Prevent the vehicle from rolling away by blocking the opposite wheel with the wheel chocks.
- ▶ Under no circumstances jack the vehicle with the fitted supports.
- ▶ If a trailer is connected: Detach the trailer before lifting the vehicle.
- ▶ Position the vehicle jack only at the mounting points intended for this purpose. See instruction manual of the base vehicle or the information in this manual in case the information in this manual differ from the instruction manual of the base vehicle.
- ▶ Never overload the vehicle jack. The maximum permissible load is specified on the vehicle jack's identification plate.



- ▶ Use the vehicle jack only for lifting the vehicle briefly while changing the tyre.
- ▶ No persons may be in the vehicle while it is raised.
- ▶ Do not start the motor while the vehicle is jacked up.
- ▶ Whilst the vehicle is in a jacked up position, persons must not lie down under it.



- ▷ Do not damage the thread of the thread bolt or wheel bolt when changing the wheel.
- ▷ Tighten the wheel nuts or wheel bolts cross-wise (Fig. 297).
- ▷ When changing wheels (e.g. alloy wheel rims or wheels with winter tyres), use the correct wheel bolts of the correct length and shape. Otherwise the wheels may not be securely fixed or the braking system may not work correctly.
- ▷ Wheel rims or tyres that are not approved for the vehicle can jeopardize road safety and they must be separately inspected and approved by an accredited test centre.
- ▷ Do not replace wheels cross-wise.



- ▷ Protect the vehicle according to the national regulations, e.g. with a hazard warning triangle.
- ▷ Before changing the wheel, check the wheel rim and tyre size, the max. tyre load and the speed index on the tyres. Only use the wheel rim and tyre sizes stated in the vehicle documents.
- ▷ Further information can be found in the instruction manual of the base vehicle.

### 14.5.2 Tightening torque

Depending on the wheel rim type and the wheel manufacturer, the wheels must be tightened with different tightening torques.

#### Steel wheel rims

Description	Tightening torque
15" Fiat/Citroen Light	170 Nm
16" Fiat/Citroen Light	170 Nm
16" Fiat/Citroen Maxi	170 Nm
16" Ford	204 Nm



Fig. 298 Steel wheel rim (Fiat)

#### Alloy wheel rims

Description	Tightening torque
16" Fiat/Citroen Light	170 Nm
16" Fiat/Citroen Maxi	170 Nm
18" Fiat/Citroen Maxi	180 Nm
16" Ford	204 Nm



Fig. 299 Citroen



Fig. 300 Fiat Light



Fig. 301 Fiat Maxi



Fig. 302 Ford

### 14.5.3 Changing a wheel



- ▶ The footplate of the vehicle jack must be levelly positioned on the ground.
- ▶ Do not tilt the vehicle jack.



- ▷ The wheel you have replaced should be repaired immediately.
- ▷ Take note of the general instructions in this chapter.



Fig. 303 Securing vehicle

- Park the vehicle on as even and stable a surface as possible.
- Switch off the engine and safeguard the area.
- Engage first gear or reverse gear.
- Apply the handbrake.
- Place wheel chocks or other appropriate objects beneath the opposite wheel of the vehicle to secure it (Fig. 303).
- Remove the spare wheel from the spare wheel support.
- If the ground is soft, place a stable support such as a wooden board beneath the vehicle jack.
- Apply the vehicle jack to the designated mounting points (refer to the instruction manual for the base vehicle).
- Using the wheel brace, turn the wheel bolts several times to loosen them, but do not remove them.
- Lift the vehicle until the wheel has been lifted 2 to 3 cm above the ground.



- Remove the wheel bolts and take off the wheel.
- Place the spare wheel on the wheel hub and adjust.
- Screw in the wheel bolts and slightly tighten them cross-wise.
- Crank down the vehicle jack and remove it.
- Using the wheel brace, tighten the wheel bolts evenly (see section 14.5.2 for tightening torque).
- Have the tightening torque checked by an authorised specialist workshop.

## 14.6 Tyre pressure



- ▶ Tyres overheat if the tyre pressure is too low. This can cause serious tyre damage.
- ▶ Check tyre pressure before a journey or every 2 weeks. Wrong tyre pressure causes excessive wear and can lead to damage or even to tyre burst. You can lose control of the vehicle.
- ▶ Use only valves that are approved for the specified tyre pressure.



- ▷ Check the tyre pressure on cold tyres. Do not reduce the higher tyre pressure when the tyres are warm.

The payload and the durability of tyres is directly dependent on the tyre pressure. Air is a volatile medium. It is unavoidable that it will escape from tyres.

As a rule of thumb it can be assumed that a filled tyre loses pressure at a rate of 0.1 bar every two months. To prevent the tyres becoming damaged or burst, check the tyre pressure regularly.

The contact surface of the tyre changes, depending on the tyre pressure.

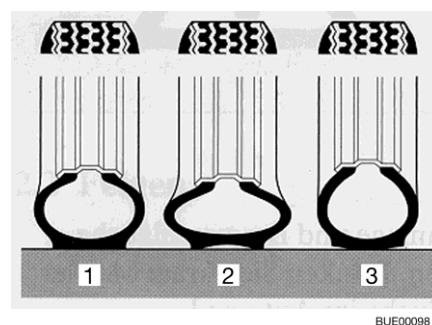

- 1 Correct tyre pressure
- 2 Tyre pressure too low
- 3 Tyre pressure too high

Fig. 304 Contact surface of the tyre



- ▷ The information on pressure levels is valid for cold tyres and loaded vehicles.
- ▷ Pressure in hot tyres must be 0.3 bar higher than in cold tyres. Recheck the pressure when the tyres are cold.
- ▷ Tyre pressures in bar.
- ▷ The tyre pressure tolerance is +/- 0.05 bar.

Description	Rim type	Type of ty-res	Air pressure in bar	
			Front	Rear
15" Fiat/Citroen Light	Steel wheel rim	CP	5.0	5.5
16" Fiat/Citroen Light	Steel wheel rim	CP	5.0	5.5
16" Fiat/Citroen Light	Alloy wheel rim	CP	5.5	5.5
16" Fiat/Citroen Maxi	Steel wheel rim	CP	5.5	5.5
16" Fiat/Citroen Maxi	Alloy wheel rim	CP	5.5	5.5
16" Fiat/Citroen Maxi tandem axle	Steel wheel rim	CP	5.5	3.8
16" Fiat/Citroen Maxi tandem axle	Alloy wheel rim	CP	5.5	3.8
18" Fiat/Citroen Maxi	Alloy wheel rim	CP	4.8	4.8
16" Ford	Steel wheel rim	CP	3.5	4.5
16" Ford	Alloy wheel rim	CP	3.5	4.5

The vehicles are constantly brought up to the newest technical standards. It is possible that new tyre sizes are not yet included in this table. If this is the case, any authorised dealer or service centre will provide the newest values.

## Chapter overview

This chapter contains instructions about possible faults in your vehicle. The faults are listed with their possible causes and corresponding remedies. The specified faults can be remedied with relative ease and without a great deal of specialised knowledge. In the event that the remedies detailed in this instruction manual should not be successful, an authorised specialist workshop must find and eliminate the cause of the fault.

### 15.1 Braking system



- ▶ Have defects on the braking system immediately remedied by an authorised specialist workshop.

### 15.2 Satellite unit

Fault	Cause	Remedy
No signal during search for satellites	No satellite found	Make sure that, towards the south, there are no obstacles in front of the satellite unit
		Make sure that the location is within the reception range of the satellite
		Make sure that the connecting cable of the signal converter (LNB) is fastened correctly on the antenna
		Make sure that all cables on the advance unit are connected correctly
Black screen	Receiver or TV set are not switched on	Switch the receiver and the TV set on
	Wrong satellite selected	Make sure that the correct satellite has been selected
The satellite unit cannot be switched on	The vehicle engine is running	Switch the vehicle engine off
	Remote control battery is empty	Change the battery
	Fuse on the supply cable is damaged	Replace fuse

Further faults can occur, which are shown by an error code on the display of the operating panel. For information on this, see the manufacturer's indications.

### 15.3 Electrical system



- ▷ When the living area battery is changed, only use batteries of the same type and the same capacity.



- ▷ See chapter 9 for changing the fuses.

Fault	Cause	Remedy
Road light system does no longer work correctly	Bulb is defective	Replace bulb. Note volts and watts specifications
	Fuse is defective	Replace fuse
Interior lighting does not work	Illuminant, plug connector or cable faulty	Contact customer service
The electrically operated entrance step cannot be moved in or out	Fuse on the transformer/rectifier is defective	Replace fuse on the transformer/rectifier
The entrance step does not extend or only partially (in the winter)	The mechanics are iced up	Clean the entrance step, remove ice
	The protection device (pinch protection) has triggered due to a overload current	
No 230 V power supply in spite of connection	230 V automatic circuit breaker has triggered	Switch on 230 V automatic circuit breaker
Starter or living area battery is not charged when operated in 230 V mode	Jumbo flat fuse on the starter or living area battery is defective	Replace jumbo flat fuse on the starter or living area battery
	No mains voltage	Switch on automatic circuit breaker in the vehicle
	Transformer/rectifier is overheated	Ambient temperature too high or transformer/rectifier ventilation hindered
	Too many appliances are switched on	Switch off appliances that are not required
	Charger module in the transformer/rectifier is defective	Contact customer service
Living area battery is not charged during vehicle operation	Fuse on terminal D+ of the alternator is defective	Replace fuse
	Disconnecter relay in the transformer/rectifier is defective	Contact customer service

Fault	Cause	Remedy
12 V indicator lamp does not light up	12 V power supply is switched off	Switch 12 V power supply on
	Battery cut-off switch on the transformer/rectifier is switched off	Set battery cut-off switch to on
	Starter or living area battery is not charged	Charge the starter or living area battery
	Disconnecter relay in the transformer/rectifier is defective	Contact customer service
	Flat fuse on the living area battery is defective	Replace flat fuse on the living area battery
12 V power supply does not work	12 V power supply is switched off	Switch 12 V power supply on
	Battery cut-off switch on the transformer/rectifier is switched off	Set battery cut-off switch to on
	Living area battery is discharged	Charge the living area battery
	Jumbo flat fuse on the living area battery is defective	Replace jumbo flat fuse on the living area battery
	Disconnecter relay in the transformer/rectifier is defective	Contact customer service
12 V power supply does not work in 230 V operation	12 V power supply is switched off	Switch 12 V power supply on
	Battery cut-off switch on the transformer/rectifier is switched off	Set battery cut-off switch to on
	230 V automatic circuit breaker has triggered	Contact customer service
	Charger module in the transformer/rectifier is defective	Contact customer service
	Jumbo flat fuse on the living area battery is defective	Replace jumbo flat fuse on the living area battery
230 V indicator lamp does not light up even though 230 V mains supply is connected	The mains connection is de-energised	Check external mains connection
	230 V automatic circuit breaker upstream of transformer/rectifier has tripped or is switched off	Reset 230 V automatic circuit breaker

Fault	Cause	Remedy
No voltage at a connected appliance	Self-resetting Polyswitch fuse has tripped	Check plug connectors and cables. Switch off 12 V power supply for approx. 2 minutes, then switch it back on
	Self-resetting Polyswitch fuse has tripped several times (3 times), system has deactivated corresponding output permanently	Remedy cause of Polyswitch tripping Cancel permanent switch-off (switch on 12 V power supply for living area, press rotary knob and keep it pressed for minimum 3 seconds)
Starter battery is discharged in 12 V operation	Disconnecter relay in the transformer/rectifier is defective	Contact customer service
	Battery cut-off switch on the transformer/rectifier is switched off	Set battery cut-off switch to on
No voltage is supplied by the living area battery	Living area battery is discharged	Charge living area battery immediately  ▷ Total discharge damages the battery. If the vehicle is to be laid up for a long period, fully charge the living area battery beforehand Discharging is caused by inactive appliances (see chapter 9)
Battery charge through solar module not working	Electrical connection to solar module interrupted	Check plug connectors and cables
	Fuse is defective	Replace fuse on the transformer/rectifier
	Solar charge regulator defective	Contact customer service
Living area battery overloaded ("hot")	Battery selection switch set wrongly	Move position of battery selection switch
	Defective load sensor or relay	Pull out the jumbo flat fuse on the living area battery, then contact customer service

## 15.4 Gas system



- ▶ In case of a defect of the gas system (gas odour, high gas consumption) there is danger of explosion! Close regulator tap on the gas bottle immediately. Open doors and windows and ventilate well.
- ▶ If the gas system is defective: Do not smoke; do not ignite any open flames, and do not operate electric switches (light switches etc.). Check the tightness of gas-conducting parts and lines with leakage search spray. Do not check with an open flame.
- ▶ Have the defective gas system repaired by an authorised specialist workshop.

Fault	Cause	Remedy
No gas	Gas bottle is empty	Change gas bottle
	Gas isolator tap closed	Open the gas isolator tap
	Regulator tap on the gas bottle is closed	Open regulator tap on the gas bottle
	External temperature is too low (-42 °C for propane gas, 0 °C for butane gas)	Wait for higher external temperatures
	Built-in appliance is defective	Contact customer service

## 15.5 Heater/boiler

In the event of a defect contact the nearest customer service workshop of the relevant appliance manufacturer. The list of addresses is enclosed with the accompanying appliance documentation. Only authorised qualified personnel may repair the appliance.

### 15.5.1 Heater/boiler with CP plus digital operating unit

Fault	Cause	Remedy
Heater does not ignite	Temperature sensor on operating unit or remote sensor defective	Pull out plug on operating unit. The heater then works without thermostat. Contact the customer service as soon as possible
No display on the operating unit	Fuse on the transformer/rectifier is defective	Replace fuse on the transformer/rectifier
	Fuse in the electronic control unit has been triggered	Contact customer service
	Living area battery defective	Charge or replace the living area battery (or have it charged or replaced)

Fault	Cause	Remedy
Fault with error code is displayed	See table "Fault search instruction"	See table "Fault search instruction"
Boiler empties, safety/drainage valve has opened	Internal temperature below 8 °C	Heat inside
Safety/drainage valve cannot be closed	Temperature at safety/drainage valve below 8 °C	Heat inside
Fan wheel runs noisily or not steadily	Fan wheel is soiled	Contact Truma service department

### Fault search instruction

Error code	Cause	Rectification
# 17	Summer operation with empty water container	Switch off the device and allow it to cool down. Fill the boiler with water
	Warm air louvres blocked	Check outlet openings
	Air circulation suction system blocked	Remove blocking of air circulation suction system
# 18	Gas pressure regulator iced up	Use regulator heater (defroster if available)
	Proportion of butane gas in gas bottle too high	Use propane gas (butane gas is unsuitable for heating especially for temperatures under 10 °C)
# 21	Room temperature sensor or cable defective	Contact customer service
# 24	Risk of undervoltage Battery voltage too low < 10.4 V	Charge the battery
# 29	Short circuit in heating element for frost control	Remove plug of heating element on electronic control unit. Replace heating element
# 41	Electronics blocked	Contact customer service
# 42	Safety switch has triggered	(Not used here)
# 43	Overvoltage > 16.4 V	Check battery voltage and voltage sources (e.g. charger)
# 44	Undervoltage Battery voltage too low < 10.0 V	Charge battery. Replace outdated battery if required
# 45	No 230 V power supply	Check external mains connection
	230 V automatic circuit breaker has triggered	Switch on 230 V automatic circuit breaker
	Overheating protection has triggered	Reset overheating protection. Allow heater to cool, remove connection cover and press reset button



Error code	Cause	Rectification
#112, #202, #121, #211	Lack of gas	Open regulator tap and gas isolator tap
		Connect a full gas bottle
#122, #212	Combustion air inlet or exhaust gas outlet closed	Check openings for dirt (slush, ice, leaves etc.) and clean if necessary
#255	No connection between heater and operating unit	Contact customer service
	Cable defective	Contact customer service

If these measures do not rectify the fault, contact customer service.

### 15.5.2 Alde heater/boiler



▷ If a fault occurs in the system, the cause is shown on the display.

Fault	Cause	Remedy
Heater does not ignite with gas operation	Lack of gas	Open regulator tap and gas isolator tap
		Connect a full gas bottle
Heater does not ignite	Battery voltage too low	Charge battery. If the battery voltage rises above 11 V, the heater is switched on automatically
Heater does not ignite at 230 V electrical operation	No 230 V power supply	Switch on 230 V automatic circuit breaker
		Connect 230 V power supply
Heater switches off	Overheating	Allow the heater to cool. Disconnect and connect the 12 V power supply to the heater again to reset the indicator
Heater running, but no heat at the convectors	Circulating pump does not work	Switch on room thermostat
		Contact customer service
Heater and circulating pump running, but no heat at the convectors	Air in the heating system	Bleed hot-water heater

## 15.6 Air conditioning unit Telair

Fault	Cause	Remedy
Air conditioning unit does not start up	No 230 V power supply	Connect 230 V power supply
	230 V automatic circuit breaker has triggered	Switch on 230 V automatic circuit breaker
	Remote control batteries empty	Change batteries (2 x AAA)
Air conditioning unit does not cool	Room temperature is lower than the preset temperature	Reset temperature
Air conditioning unit does not heat	Room temperature is higher than the preset temperature	Reset temperature
Insufficient ventilation rating	Ventilation flaps closed	Open at least one ventilation flap
	Filter dirty	Clean the filter
Water is entering the vehicle	Drainage holes for condensation are clogged	Clean air conditioning unit

## 15.7 Cooker

### 15.7.1 Gas cooker

Fault	Cause	Remedy
Ignition fuse does not operate (flame does not burn after the control knobs are released)	Heat-up time is too short	Keep control knob pressed for approx. 15 to 20 seconds after ignition
	Ignition fuse is defective	Contact customer service
Flame extinguishes when being reduced to its minimum setting	Thermocouple sensor is incorrectly set	Correctly reset thermocouple sensor (do not bend). The sensor tip should protrude by 5 mm beyond the burner. The sensor neck should not be more than 3 mm away from the burner ring; if necessary, contact customer service

### 15.8 Extractor hood

Fault	Cause	Remedy
Extractor hood does not work	230 V automatic circuit breaker is switched off	Switch on 230 V automatic circuit breaker
	Fuse (15 A) at the transformer/rectifier is defective	Replace fuse (15 A)
	Extractor hood is defective	Contact customer service

### 15.9 Microwave oven



► Only qualified personnel may repair the microwave oven. Improper repairs can cause major risks to the user.

Fault	Cause	Remedy
Microwave oven does not cut in	Fuse is defective	Replace fuse
	Door of the microwave oven is not properly closed	Remove foreign bodies stuck in the door of the microwave oven and close door properly

## 15.10 Refrigerator

### 15.10.1 General

In the event of a defect contact the nearest customer service workshop of the relevant appliance manufacturer. The list of addresses is enclosed with the accompanying appliance documentation. Only authorised qualified personnel may repair the appliance.



- ▷ Further information can be obtained in the manufacturer's instruction manual.

Fault	Cause	Remedy
Refrigerator does not refrigerate sufficiently	Insufficient ventilation of unit	Check if ventilation grills are covered; remove covers if necessary
		Remove ventilation grills and clean the space behind them (of leaves etc.)
	Thermostat adjusted too low	Adjust higher value on thermostat
	Cooling fins heavily iced-over	Check if refrigerator door closes correctly
	Too many warm foods stored in a short period of time	Let warm foods cool down before storage
	Appliance has not been running long enough	Check again after 4 or 5 hours if the refrigerator cools
	Ambient temperature is too high	Remove the ventilation grills periodically
Refrigerator does not refrigerate in gas operation	Lack of gas	Connect a full gas bottle
		Open regulator tap and gas isolator tap
	Air in the gas pipe	Switch appliance off and start it up again (if necessary, repeat procedure 3 to 4 times)
Refrigerator does not refrigerate in 12 V operation	Fuse is defective	Replace fuse
	Battery is discharged	Check and charge battery
	Ignition switched off	Switch on ignition
	Heating element is defective	Contact customer service
Refrigerator does not refrigerate in 230 V operation	Fuse is defective	Change fuse; switch fuse on again at fuse box
	No 230 V power supply	Connect 230 V power supply
	Heating element is defective	Contact customer service

Fault	Cause	Remedy
Refrigerator changes into gas mode in spite of mains connection	Line voltage too low	Check line voltage (refrigerator will automatically change into 230 V operation in case of correct line voltage)







### 15.10.2 Dometic 10 series

Faults are signalled with a warning symbol, a fault code and an alarm tone. The alarm tone sounds 2 minutes and is repeated every 30 minutes until the fault has been remedied.



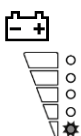





On a refrigerator with a TFT display, the fault message is shown on the middle line of the display.

On a refrigerator with LED display, the fault indicator (general danger sign) lights up. In addition, the LED of the affected function will be flashing.

**Warnings** All faults of the "WARNING" type are automatically reset after the fault has been remedied.

Indication TFT display	Indication LED display	Cause	Remedy
W01		Temperature sensor in the refrigerator compartment defective	Contact customer service
W05		230 V power supply not connected or voltage < 190 V	Connect 230 V power supply or select another type of energy (gas or 12 V)
W06		No 12 V power supply present	Connect 12 V power supply or select another type of energy (gas or 230 V)
W11		Direct current overvoltage (> 16 V)	Contact customer service
		Fuel stop mode Gas operation is blocked for 15 minutes	Wait 15 minutes or select another operating mode
 W10 + alarm tone	Alarm tone	Door has been open for longer than 2 minutes	Close door

**Error** All faults of the "ERROR" type must be reset manually. In order to do this, press the control knob for 2 seconds.

Indication TFT display	Indication LED display	Cause	Remedy
E03		No connection between power module and display	Contact customer service
E07		No cooling power in gas operation mode	Check if the appliance is in a tilted position, and correct the position if necessary. Reset the error. Contact customer service if the error persists
E08		No cooling power with 230 V operation	Check if the appliance is in a tilted position, and correct the position if necessary. Reset the error. Contact customer service if the error persists
E09		No cooling power with 12 V operation	Check if the appliance is in a tilted position, and correct the position if necessary. Reset the error. Contact customer service if the error persists
E12		Error during gas valve test	Gas operation is not possible. Reset the error. Contact customer service if the error persists
E13		Internal communication error	Gas operation not possible. Reset the error. Contact customer service if the error persists
E50		Gas cut-off after 3 ignition intents	Ignition not possible. Gas bottle is empty. Change the gas bottle. Reset the error
E51		Gas cut-off, internal error in the power module	Reset the error. Contact customer service if the error persists
E52		Contact to ground, gas valve	Reset the error. Contact customer service if the error persists



Indication TFT display	Indication LED display	Cause	Remedy
E53		Contact to ground, ignition electrode	Reset the error. Contact customer service if the error persists



▷ Observe the notes and information on the subject of malfunctions/troubleshooting in the separate instruction manual from the manufacturer.

### 15.10.3 Thetford N4000

For certain faults, indicators also flash on the operating panel.

Fault	Cause	Remedy
LEDs for types of energy and display of the temperature range flash	Refrigerator does not work	Switch the refrigerator off and on again Check availability of an energy source
LED "  " and LEDs for display of the temperature range flash	No 230 V power supply	Connect 230 V power supply
	230 V automatic circuit breaker has triggered	Switch on 230 V automatic circuit breaker
	230 V operating voltage too low	Have the 230 V power supply checked by an authorised specialist workshop
LED "  " and LEDs for display of the temperature range flash	Fuse on the transformer/rectifier is defective	Replace fuse on the transformer/rectifier
	Disconnecter relay in the transformer/rectifier is defective	Contact customer service
	12 V operating voltage too low	Have the 12 V power supply checked by an authorised specialist workshop
	No D+ signal	Contact customer service
LED "  " and LEDs for display of the temperature range flash	Lack of gas	Open regulator tap and gas isolator tap Connect a full gas bottle
	Cobwebs or burnt residue in the burning chamber	Remove the ventilation grill on the outside of the vehicle and clean the burning chamber



▷ Observe the notes and information on the subject of malfunctions/troubleshooting in the separate instruction manual from the manufacturer.

## 15.10.4 Thetford T2000

Fault	Cause	Remedy
Refrigerator does not cool, compressor does not start up	Battery voltage is too low	Charge the battery
	Start delay by 1 minute (no error)	Wait 1 minute
	Overheating due to high ambient temperature	Leave the refrigerator off for an hour, ventilate the vehicle, switch to daytime operation
	Vehicle fuse has blown	Check fuse value, replace with 15 A
Freezer compartment does not freeze	Interior temperature in the vehicle is less than 16 °C	Raise the temperature inside the vehicle and/or select at least cooling level 4
Refrigerator does not cool, compressor starts but switches off again immediately	Overheating due to high ambient temperature	Leave the refrigerator off for an hour, ventilate the vehicle, switch to daytime operation
Refrigerator is cooling too intensely	Temperature setting is too high	Select lower temperature setting
Refrigerator does not cool, compressor runs without interruption		Contact customer service
Refrigerator has too little cooling capacity	Overheating due to high ambient temperature	Leave the refrigerator off for an hour, ventilate the vehicle, switch to daytime operation
	Ventilation openings are completely or partially blocked	Clean ventilation openings or remove blockage
	Door is not closed correctly	Close the door and check if the door seal is in good condition
	Too much ice on evaporator (more than 3 mm)	Defrost the evaporator and check that the door seal is in good condition



- ▷ Observe the notes and information on the subject of malfunctions/troubleshooting in the separate instruction manual from the manufacturer.



15.10.5 Dellcool



▷ In the event of a fault, the red warning light on the refrigerator will be flashing. In addition, one or more cooling level setting indicator lamps will be flashing (in different combinations depending on the fault). The meaning of the various combinations of flashing indicator lamps is described in the manufacturer's separate instruction manual.

Fault	Cause	Remedy
Compressor is not running, refrigerator is not cooling	Power supply disrupted	Charge the battery Check fuse on the transformer/rectifier and replace if necessary Check supply line
	Ambient temperature is too high	Switch off the refrigerator for 1 hour Ventilate the vehicle Switch off the night mode
	Ventilation openings entirely or partially blocked	Clean ventilation openings, remove blockage
	Condenser dirty	Clean condenser
	Compressor is defective	Contact customer service
Compressor is only running rarely, refrigerator is not cooling sufficiently	Battery voltage too low	Charge the battery Switch off the night mode
Compressor is permanently running, refrigerator is nevertheless not cooling	Ambient temperature is too high	Switch off the refrigerator for 1 hour Ventilate the vehicle
	Ventilation openings entirely or partially blocked	Clean ventilation openings, remove blockage
	Fan is defective	Contact customer service
Refrigerator makes loud noises	Component of the cooling circuit vibrates against another component	Carefully bend the component to the side
	Foreign body trapped between refrigerator and wall	Remove foreign body
	Fan is defective	Contact customer service

## 15.11 Water supply

Fault	Cause	Remedy
Leakage water inside the vehicle	A leak has occurred	Identify leak, re-connect water pipes
No water	Water tank is empty	Replenish drinking water
	Drain cock not closed	Close drain cock
	12 V power supply is switched off	Switch 12 V power supply on
	Fuse of the water pump is defective	Replace fuse on the transformer/rectifier
	Water pump defective	Exchange water pump (have it exchanged)
	Water pipe snapped off	Straighten water pipe or replace
	Transformer/rectifier defective	Contact customer service
	Water pump switched off on panel	Switch water pump on
Toilet has no flush water	Water tank is empty	Replenish drinking water
	Fuse for toilet is defective	Replace fuse
Display for water and waste water indicates a wrong value	Measuring probe in the waste water or water tank is soiled	Clean water/waste water tank
	Measuring probe is defective	Replace measuring probe
Waste water tank cannot be emptied	Drain cock is clogged	Open the cleaning cap on the waste water tank and drain the waste water. Rinse the waste water tank well
Drain on the single lever mixer tap is clogged	Perlator calcified	De-calcify or replace perlator
Water jets on the shower nozzle clogged	Water jets calcified	De-calcify shower nozzle or rub off nozzle burling
Water drains from the shower tray slowly or does not drain at all	The vehicle is not in a horizontal position	Position the vehicle horizontally

Fault	Cause	Remedy
Milkiness of the water	Tank filled with dirty water	Clean water tank mechanically and chemically; then disinfect and rinse copiously with drinking water
	Residues in the water tank or water system	Clean water system mechanically and chemically; then disinfect and rinse copiously with drinking water
Any change in the taste or odour of the water	Tank filled with dirty water	Clean water system mechanically and chemically; then disinfect and rinse copiously with drinking water
	Fuel filled into the water tank by mistake	Clean water system mechanically and chemically; then disinfect and rinse copiously with drinking water. If not successful: Contact a specialist workshop
	Microbiological deposits in the water system	Clean water system mechanically and chemically; then disinfect and rinse copiously with drinking water
Deposits in the water tank and/or water-carrying components	Water excessively long in the water tank and in water-carrying components	Clean water system mechanically and chemically; then disinfect and rinse copiously with drinking water

## 15.12 Body

Fault	Cause	Remedy
Flap hinges/door hinges are difficult to operate	Flap/door hinges are not (sufficiently) lubricated	Lubricate flap hinges/door hinges with acid-free and resin-free grease
Hinges/joints in the bathroom unit/toilet compartment are difficult to operate/make a grating noise	Hinges/joints are not (sufficiently) lubricated	Lubricate hinges/joints with solvent-free and acid-free grease  ▷ Spray cans often contain solvents
Storage compartment hinges are difficult to operate/make a grating noise	Storage compartment hinges are not (sufficiently) lubricated	Lubricate storage compartment hinges with acid-free and resin-free grease
Electric pull-down bed does not move	Fuse on the transformer/rectifier or on the pull-down bed drive motor faulty	Replace fuse
	Living area battery is empty or the transformer/rectifier has switched off due to insufficient voltage	Charge the living area battery
	Drive is defective	In an emergency, the pull-down bed can be moved manually; afterwards, contact customer service



- ▷ The authorised dealers and service centres are available for any spare parts requirement.

## 16.1 Weight details for optional equipment



- ▶ The use of accessories, parts and fittings not supplied by us may cause damage to the vehicle and jeopardize road safety. Even if an expert's report, a general type approval or a design certification exists, there is no guarantee for the proper quality of the product.
- ▶ Every alteration of the original condition of the vehicle can alter road behaviour and jeopardize road safety.
- ▶ No liability can be assumed for damage caused by products which have not been released by us. This also applies to impermissible alterations to the vehicle.

Depending on the model series, different optional equipments are offered. You can find out which optional equipments are available for your vehicle in the separate document "Price List & Technical Data". There you will also find information on the weights of the individual optional equipments.



- ▷ The factory installation of optional equipment increases the actual weight of the vehicle and reduces the pay-mass. The additional weight indicated for packages and optional equipment shows the surplus weight compared to the standard equipment of the respective model or ground plan.
- ▷ The total weight of the selected optional equipment must not exceed the manufacturer's specified mass for optional equipment in the model overviews. This is a calculated value for each type and ground plan, with which Bürstner determines the maximum weight available for factory-fitted optional equipment.
- ▷ For detailed notes and explanations on the weight issue, see chapter 20.
- ▷ For further information about the payload issue, see section 4.3.1 in this instruction manual.
- ▷ In the event of an increase of the GVW, the mass specified by the manufacturer for optional equipment increases. The increase results from the higher pay-mass due to the alternative chassis. The increased net weight of the alternative chassis and, in particular, the weight of any mandatory heavier engine variants (e.g. 180 hp) must be deducted from this.



### 17.1 View of ground plans

**Explanations**

- (1) 230 V fuse
- (2) Transformer/rectifier with 12 V fuses
- (3) Living area battery with main fuse
- (4) Water pump mounted in the tank area
- (5) Drain cock, waste water tank
- (6) Safety/drainage valve
- (7) Boiler/heater
- (8) Water drain cock - yellow
- (9) Water tank
- (10) Alde hot-water heater
- (11) Alde compensator reservoir
- (12) Alde auxiliary heat exchanger
- \* Access via service flap
- \*\* Beneath the vehicle

Specifications without guarantee

**Limited T**

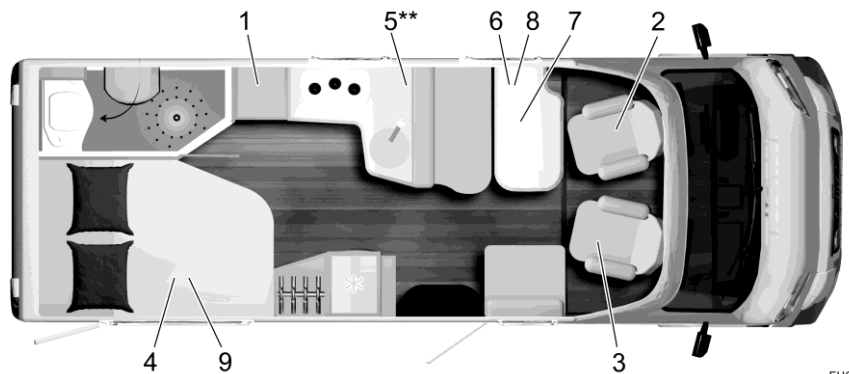

EHG01144

Fig. 305 Ground plan Limited T 660

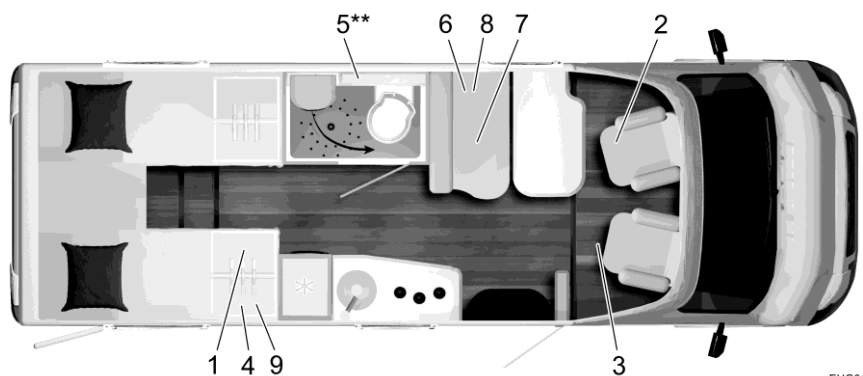

EHG01145

Fig. 306 Ground plan Limited T 690 G

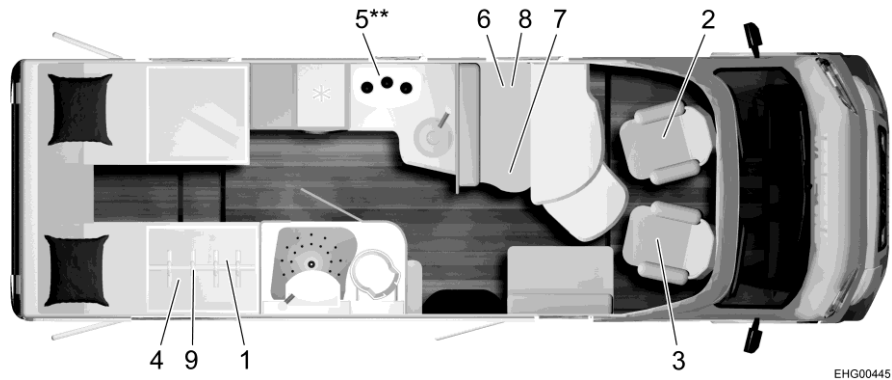

EHG00445

Fig. 307 Ground plan Limited T 726 G

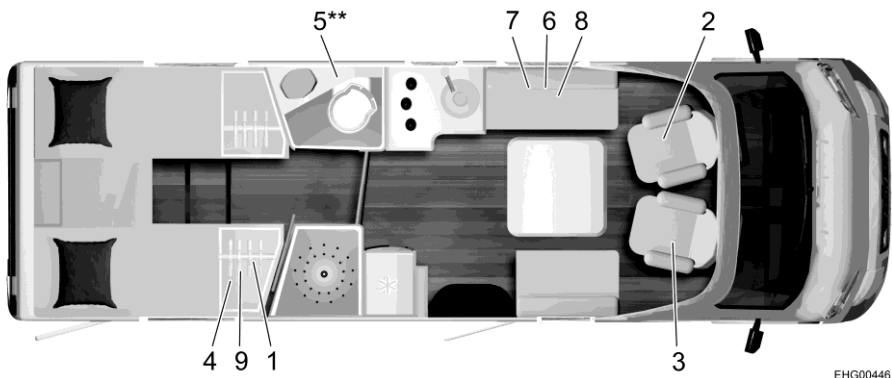

EHG00446

Fig. 308 Ground plan Limited T 727 G

Lineo T

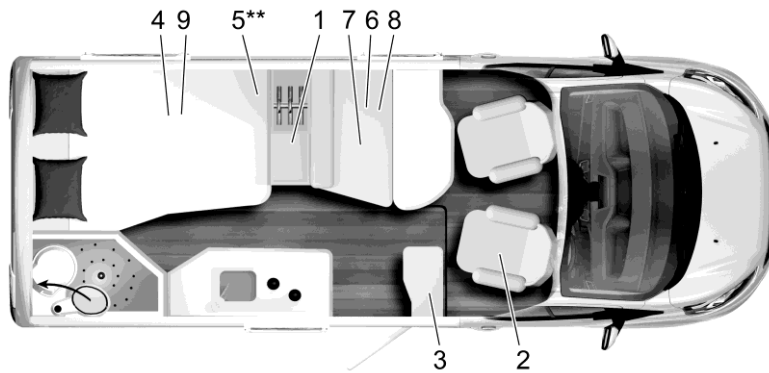

EHG01137

Fig. 309 Ground plan Lineo T 569



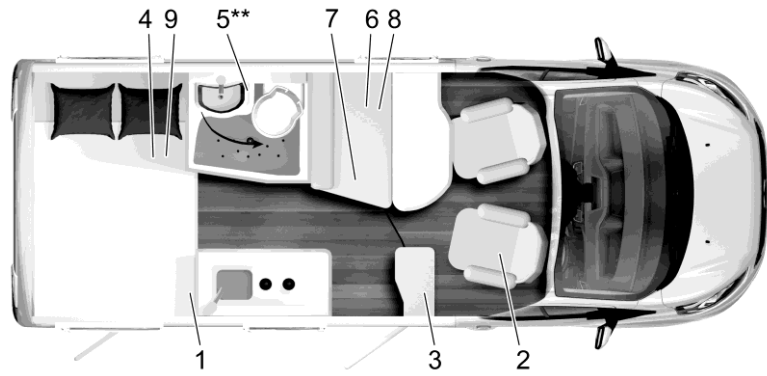

EHG01138

Fig. 310 Ground plan Lineo T 590 G

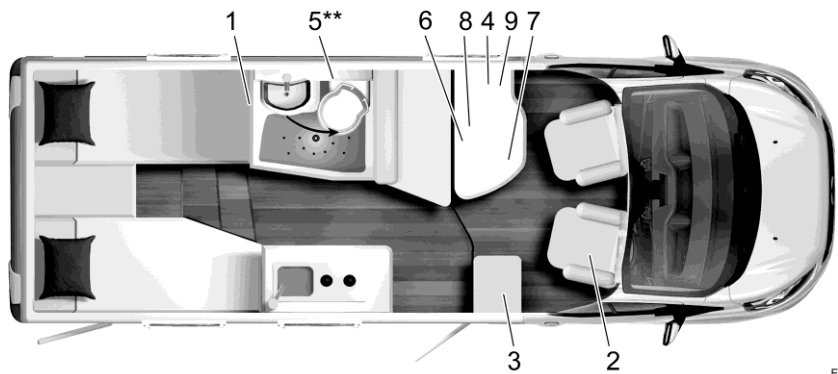

EHG01139

Fig. 311 Ground plan Lineo T 620 G

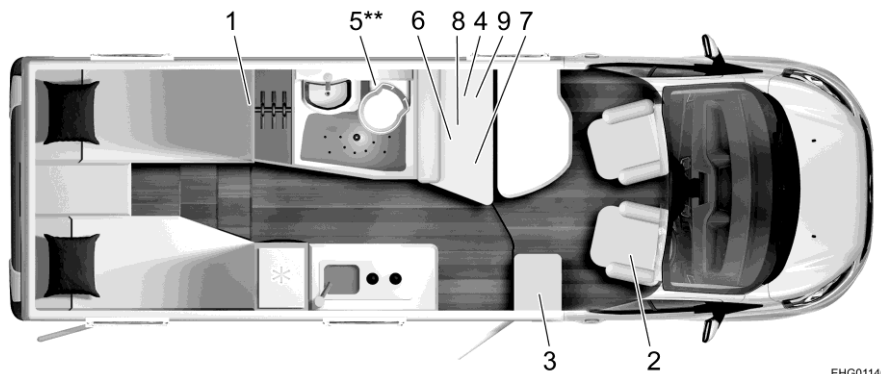

EHG01140

Fig. 312 Ground plan Lineo T 690 G

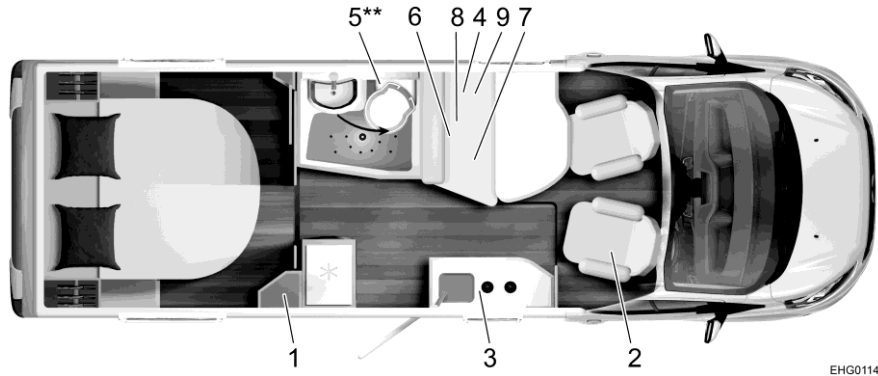

EHG01141

Fig. 313 Ground plan Lineo T 700

Lyseo TD / Harmony Line /  
Privilège

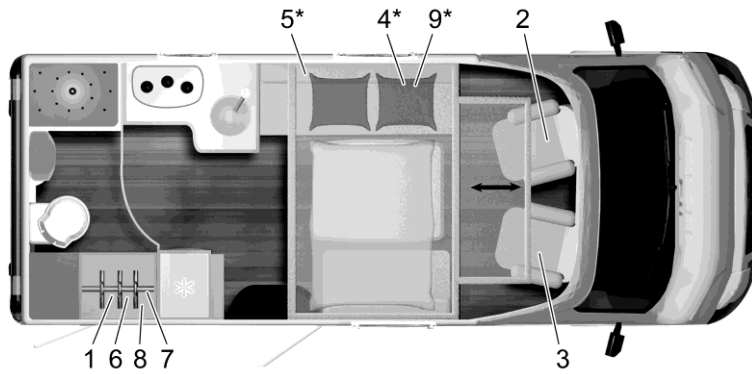

EHG01142

Fig. 314 Ground plan IT 594

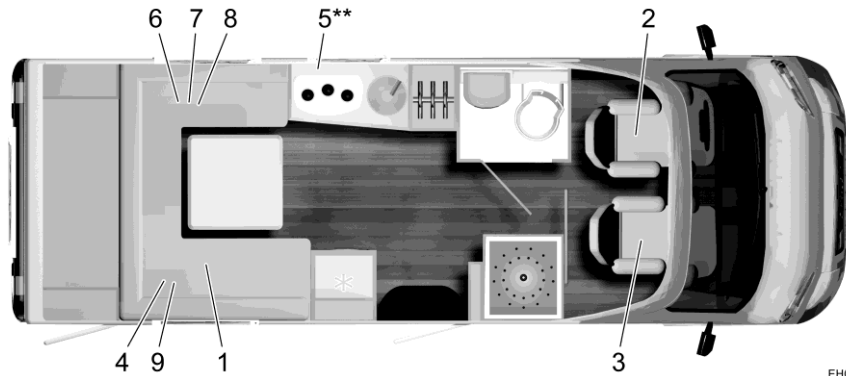

EHG00454

Fig. 315 Ground plan IT 644 G

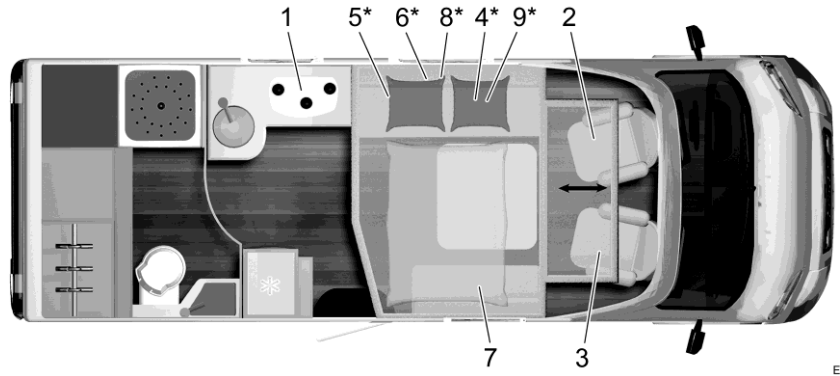

EHG01143

Fig. 316 Ground plan IT 684 G

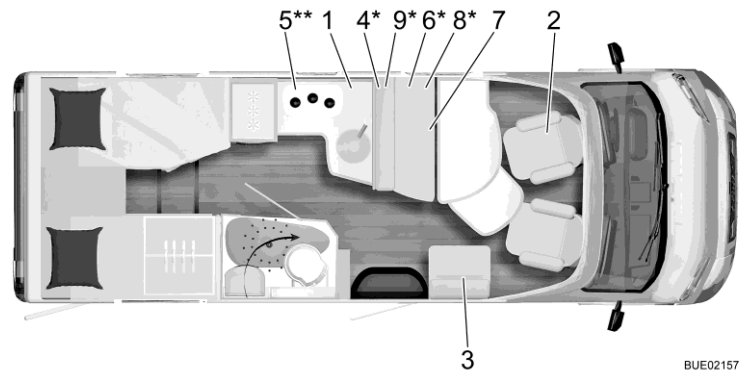

BUE02157

Fig. 317 Ground plan IT 690 G

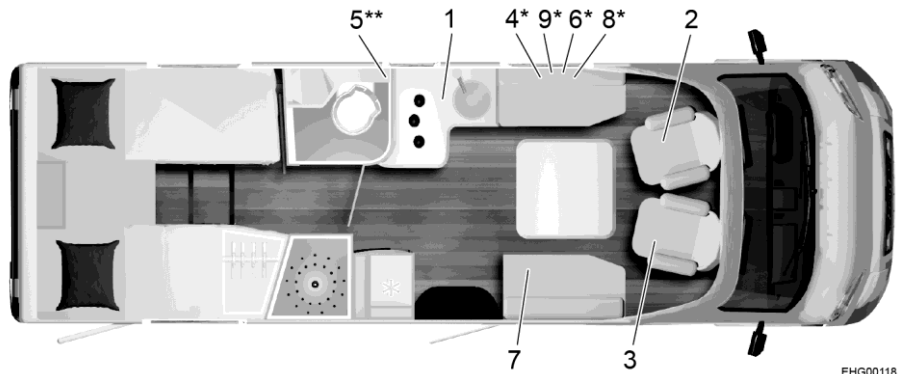

EHG00118

Fig. 318 Ground plan IT 727 G

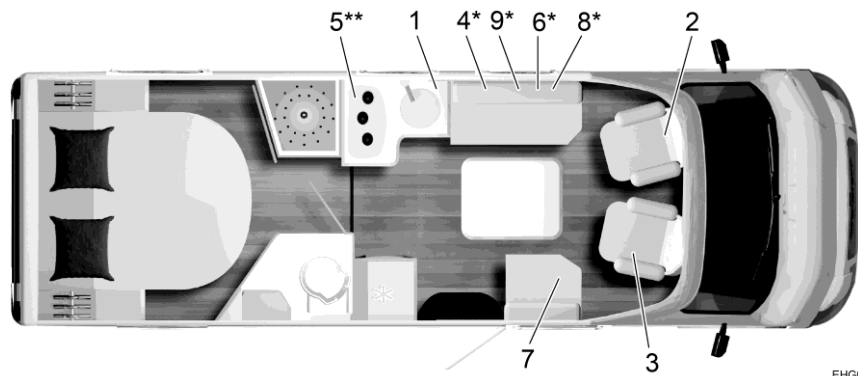

EHG00294

Fig. 319 Ground plan IT 732

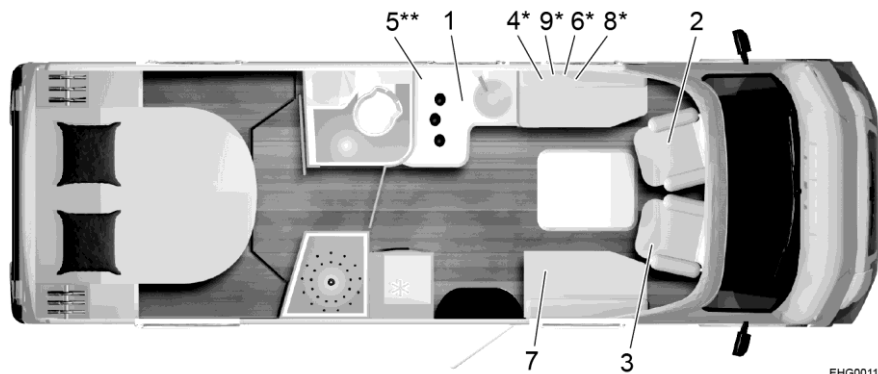

EHG00119

Fig. 320 Ground plan IT 736

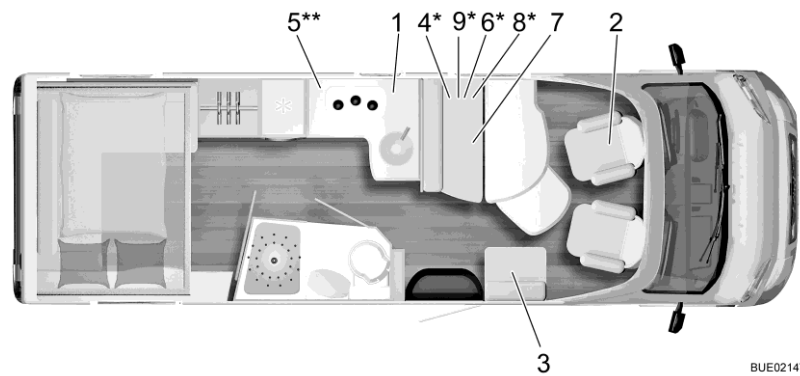

BUE02147

Fig. 321 Ground plan IT 744

17.2 Table of linear measures / sleeping places

Type	Wheelbase in cm	Length in cm	Width in cm	Height in cm	Regular/additional sleeping places
Limited T T 660	380	695	232	295	2/3/5*
T 690 G	380	698	232	295	2/3/4**
T 726 G	403.5	742	232	295	2/3/5*
T 727 G	403.5	742	232	295	2/3/5*

Lineo T (Ford) T 569	330	599	220	285	2/3*
T 590 G	330	599	220	285	2/3*
T 620 G	375	660	220	285	2/3*
T 690 G	375	699	220	285	2/3*
T 700	375	699	220	285	2/3*

Lyseo TD / Harmony Line / Privilège 594	380	599	230	295	2/4**
644 G	380	699	230	295	4
684 G	403.5	689	230	295	2/4**
690 G	403.5	699	230	295	2/5***
727 G	403.5	736	230	295	2/5***
732	403.5	719	230	295	2/5***
736	403.5	736	230	295	2/5***
744	403.5	749	230	295	2/5***

\* Additional bed: accessories "Vario-Seat"

\*\* 3. + 4. Sleeping area: Accessories "Central seating group, convertible into bed"

\*\*\* 3rd and 4th sleeping place: accessories "Pull-down bed above central seating group / 5th Sleeping area: accessories "Central seating group, convertible into bed"



## Chapter overview

This chapter contains helpful tips for the journey.

At the end of the chapter there is a checklist containing the most important equipment for the journey.

### 18.1 Traffic rules in foreign countries



- ▷ The vehicle driver is required to inform himself as to the traffic rules of the countries in which he plans to travel before beginning the trip. Contact your automobile club or embassy for further information.
- ▷ In some European countries, warning vests must be worn when exiting the vehicle outside of towns in the case of vehicle failures or accidents.
- ▷ Depending on the country, different rules and regulations apply (e.g. different warning signs for rear carriers, obligation to carry breathalyzer kits, spare bulbs, high-visibility vests, size of reserve canister). The driver of the vehicle must familiarise him or herself with these rules before every journey.
- ▷ Up-to-date information can generally be found on the web pages of the national automobile associations.

Information about traffic regulations is especially important as state law applies in case of damage. For your own safety, always observe the following rules when travelling abroad:

- Carry your insurance certificate with you.
- Always register accidents with the police.
- Never sign documents that you have not read and understood completely.

### 18.2 Help on Europe's roads



- ▷ Before commencing the trip, gather information on national phone numbers for rescue and police. In many countries the central emergency phone number 112 (without area code) applies.
- ▷ As far as possible, draw up a list with the important phone numbers in the travelled countries and keep the table in the vehicle.

Motoring clubs at home or in the travelled country are happy to help.

### 18.3 Gas supply in European countries



- ▷ In Europe, there are several different connection systems for gas bottles. It is not always possible to fill or exchange your gas bottles in a foreign country. Get information about the connection system in the country you are travelling to before embarking on your journey, e.g. at a motoring club or in the trade press.

#### General tips

Always observe the following instructions:

- Only go on vacation with completely filled gas bottles.
- Use all of the gas bottles' capacity.
- Take along adapter sets (available in camping supply stores) for filling gas bottles in foreign countries and for connecting the gas pressure regulator to foreign gas bottles.
- During the cold time of the year observe filling with propane gas component (butane does not gas below 0 °C).
- Use blue bottles from the firm Campingaz (distributed world-wide). Only use gas bottles with safety valves.
- When bottles from other countries are used, check the gas bottle compartments to see if the gas bottles fit into them. Gas bottles from other countries do not always display the same size as your own gas bottles.
- The web site [www.mylpg.eu](http://www.mylpg.eu) provides an overview of gas suppliers in Europe.

### 18.4 Toll regulations in European countries

Many European countries have introduced a mandatory toll system. The toll regulations and how they are collected vary greatly from country to country. Nevertheless, ignorance is no excuse. Penalties can be quite severe.

As is the case with traffic regulations, the vehicle driver is required to be familiar with the toll formalities before starting out on a trip. For example, in Austria the vignette does not meet the toll requirements for vehicles that weigh more than 3.5 t. There, a so-called "Go-Box" must be obtained and charged.

Contact your automobile club or the Internet for further information.



- ▷ Windscreens with solar filters can affect the functioning of automatic toll collection systems (e.g. Go-Box). This must be taken into account when acquiring the appropriate device (e.g. Split-Go-Box).



## 18.5 Tips on staying overnight safely during travel

Prudent behaviour is the most important protective measure for insuring a safe night in the vehicle.

The risk of thievery is reduced to a minimum when the following basic rules are observed:

- During high season do not spend the night at highway rest stops or parking areas located along typical vacation routes.
- Several vehicles on one site at the same time do not necessarily decrease the chances of thievery occurring. Consult your own feelings about the parking site.
- Even if it is just for one night, go to a camping site.
- When parking on open space keep emergency routes clear. The way to the driver's seat should be clear. The ignition key should always be within reach.
- Only take with you those valuables which are absolutely necessary for the journey. If possible, store valuables in a small safe and not in the immediate vicinity of windows or doors.
- Always lock up the vehicle.

## 18.6 Tips for winter campers

The following tips will help make your winter camping experience as agreeable as possible.

- Reserve your parking place in good time. Good winter camping sites are often booked up early.
- Do not start your trip without winter tyres.
- Bring snow chains.
- Choose your parking place with care. Observe the ground beneath you. Snow and ice may melt.
- When the vehicle has been positioned, release the handbrake to prevent freezing.
- No snow walls should be allowed to cover the built-in forced ventilation.
- Keep the built-in forced ventilation free from snow and ice.
- Make sure the air circulation is good. Good air circulation prevents moisture from collecting and makes it easier to heat the living area.
- Cover the single-paned driver's cabin window with insulation mats to avoid thermal bridges.
- Follow the instructions in the section "Gas supply in European countries".
- Use a two-bottle system with automatic controller for the gas system, so that the supply does not run out during the night.
- Only operate the gas system using propane gas.
- Do not use the space behind the heater as a storage space.
- Never operate catalytic ovens or infra-red gas radiators in the interior of the vehicle, since they consume oxygen for burning.
- Lay the 230 V power cable in such a way that the cable cannot be frozen or be damaged (e.g. during snow removal).
- When it is snowing heavily, clear the roof of the vehicle of snow regularly. A few centimetres of powdery snow serves as insulation, but wet snow quickly becomes a heavy burden.
- Before embarking on the return journey, remove all the snow from the roof to avoid impeding vehicles behind you with a "snow flag".

## 18.7 Travel checklists

The following checklists will help that nothing important is left at home although not everything on the checklists might be necessary.



- ▷ Do not leave checking of documents (e.g. vehicle papers and information) as well as checking the condition of the vehicle until just before commencing the trip. Planning and checking documents well in advance will save unnecessary trouble.

### Kitchen area

✓	Object	✓	Object	✓	Object
	Wiping cloth		Cleansing agent (detergent)		Salad servers
	Silverware		Dishcloths		Chopping board
	Turnspit		Glasses		Brush to wash the dishes
	Can opener		Set of knives and forks for grilling		Cloth to wash the dishes
	Ice cube tray		Corkscrew		Matches
	Lighter		Kitchen paper		Thermos jug
	Bottle opener		Garbage bags		Pots
	Air-tight storage boxes		Frying pans		
	Crockery		Stirring spoons		

### Bathroom/sanitary items

	Towels		Sanitary items		Toilet paper
	Hygiene products		Toilet brush		Toothbrush glass

### Living area

	Dustbin		Deck of cards		Rucksack
	Road atlas		Broom		Sleeping bags
	Bath towels		Dust pan		Pencils and paper
	Bath shoes		Candles		Shoes
	Batteries		Coat-hangers		Shoe polish
	Bed linen		Clothes brush		Sports equipment
	Laundry bag		Pillow		Vacuum cleaner
	Books		Map		Flash light
	Camping guide/parking space directory		Medicine		Pocket knife
	Binoculars		Mobile phone		Table cloth
	Fire extinguisher		Sewing kit		Drinking bottle
	Gas bottle		Rain clothes		Clothes pins
	Insect lamp		First aid kit		Clothesline
	Insect repellent		Travel guide		

**Vehicle/tools**

✓	Object	✓	Object	✓	Object
	Waste water container		Gas tube		Snow chains (winter)
	Adapter socket		Fabric tape		Screwdriver
	CEE adapter		Watering can for drinking water		Current-measuring instrument
	Wire		Cable reel		Wheel chocks
	Spare wheel		Glue		First-aid kit
	Spare lamps		Universal pliers		Vehicle jack
	Spare fuses		Compressor		Hazard warning triangle
	Hammer		Loops		Warning sign
	Flat wrench		Tube adapter		Warning vest(s)
	Gas filling adapter		Hose clips		Flashing hazard warning light

**Outside**

	Stay rope		Camping table		Lock
	Bellows		Luggage racks		String
	Camping chairs		Grill		Tent pegs/tightening ropes

**Documents**

	List of addresses		Registration book		Passport
	Registration confirmation(s)		Driving licence		Writ of protection
	Allergy certificate		Vaccination certificate		Insurance documents
	Instruction manuals		Credit card		Vignette/toll card
	Instruction leaflets for medicines		Identity card		Visa



Pos.	Component	Activity	Interval
1	Auxiliary support	Lubrication	Annually
2	Tyres and wheel rims	Air pressure check (see section 14.6). Visual check for damage	Annually
3	Outside lighting	Function check	Annually
4	Joints, hinges	Lubrication	Annually
5	Refrigerator, heater, boiler, cooker, lighting, flap and door closures, toilet, seat belts	Function check	Annually
6	Windows, skylights	Function check, water ingress test	Annually
7	Cushions, curtains, blinds	Visual check	Annually
8	Sealing strips, edges, rubber	Check for damage	Annually
9	Water supply	Water ingress test	Annually
10	Hot-air system	Function check, clean fan wheel as necessary	Annually
11	Floor skirt attachment	Visual check	Annually
12	Pull-down bed suspension	Function check	Annually
13	Electrical system	Function check	Annually
14	Air suspension (special equipment)	Conservation	Annually
15	Gas system	Official gas inspection	Every two years
16	Connections between the chassis and body	Check	Every two years

Delivery _____ Item 1-14	
Stamp of the Bürstner dealer	
Date	Signature

1st year _____ Item 1-14	
Stamp of the Bürstner dealer	
Date	Signature

2nd year _____ Item 1-16	
Stamp of the Bürstner dealer	
Date	Signature

3rd year _____ Item 1-14	
Stamp of the Bürstner dealer	
Date	Signature

4th year _____ Item 1-16	
Stamp of the Bürstner dealer	
Date	Signature

5th year _____ Item 1-14	
Stamp of the Bürstner dealer	
Date	Signature

6th year _____ Item 1-16	
Stamp of the Bürstner dealer	
Date	Signature

7th year _____ Item 1-14	
Stamp of the Bürstner dealer	
Date	Signature

8th year _____ Item 1-16	
Stamp of the Bürstner dealer	
Date	Signature

The weight specifications and tests for motorhomes are uniformly regulated throughout the EU in EU Implementing Regulation No. 2021/535 (until June 2022: EU Implementing Regulation No. 1230/2012). We have summarised and explained the key terms and legal requirements from this regulation for you below. Our dealers and the Bürstner configurator on our website offer you additional assistance in configuring your vehicle.

### 1. Technically permissible maximum laden mass

The technically permissible maximum laden mass of the vehicle (e. g. 3,500 kg) is a mass specification set by the manufacturer which the vehicle must not exceed. Information on the technically permissible maximum laden mass of the model you have chosen can be found in the technical data. If the vehicle exceeds the technically permissible maximum laden mass in everyday driving, this constitutes an administrative offence which may result in a fine.

### 2. Mass in running order

In simple terms, the mass in running order is the basic vehicle with standard equipment plus a legally fixed standard weight of 75 kg for the driver. This essentially includes the following items:

- the unladen weight of the vehicle together with the bodywork, including operating fluids such as greases, oils and coolants;
- the standard equipment, i.e. all equipment items that are included as standard in the factory-fitted scope of delivery;
- the fresh water tank filled to 100 % in driving mode (driving fill according to manufacturer's specifications; 20 litres) and an aluminium gas cylinder filled to 100 % with a weight of 16 kg;
- the fuel tank, which is 90 % full, including fuel;
- the driver, whose weight – regardless of the actual weight – is generally specified as 75 kg in accordance with EU law.

Information on the mass in running order can be found for each model in our sales documents. It is important to note that the value for mass in running order given in the sales documents is a default value determined in the type-approval procedure and verified by the authorities. It is legally permissible and possible for the mass in running order of the vehicle delivered to you to deviate from the nominal value stated in the sales documents. The legally permissible tolerance is  $\pm 5\%$ . In this way, the EU legislator accounts for the fact that certain fluctuations in the mass in running order occur due to variations in the weight of supplied parts as well as due to processes and weather conditions.

These weight deviations can be illustrated by means of an example calculation:

- Mass in running order acc. to sales documents: 2,850 kg
- Legally permissible tolerance of  $\pm 5\%$ : 142.50 kg
- Legally permissible range of mass in running order: 2,707.50 kg to 2,992.50 kg

The specific range of permissible weight deviations can be found for each model in the technical data. Bürstner makes great efforts to reduce weight variations to the minimum that is unavoidable for production reasons. Deviations at the upper and lower end of the range are therefore very rare; however, they cannot be completely ruled out technically, even with all optimisations. The real weight of the vehicle and compliance with the permissible tolerance is therefore checked by Bürstner by weighing each vehicle at the end of the line.

### 3. Mass of the passengers

The mass of the passengers is set a standard value of 75 kg for each seat provided by the manufacturer, regardless of the actual weight of the passengers. The mass of the driver is already included in the mass in running order (see no. 2 above) and is therefore not included again. In the case of a motorhome with four permitted seats, the mass of the passengers is therefore  $3 \times 75 \text{ kg} = 225 \text{ kg}$ .

### 4. Optional equipment and actual mass of the vehicle

Optional equipment (also: additional equipment) includes, according to the legal definition, all optional equipment parts not included in the standard equipment which are fitted to the vehicle under the responsibility of the manufacturer – i.e. ex works – and can be ordered by the customer (e. g. awning, bicycle or motorbike carrier, satellite system, solar system, oven, etc.). Information on the individual or package weights of the optional equipment that can be ordered can be found in our sales documents. Optional equipment in this sense does not include other accessories that are retrofitted by the dealer or you personally after the vehicle has been delivered ex works.

The mass of the vehicle in running order (see no. 2 above) and the mass of the optional equipment fitted to a specific vehicle at the factory are together referred to as the actual mass. You will find the corresponding information for your vehicle after handover under item 13.2 of the Certificate of Conformity (CoC). Please note that this specification also represents a standardised value. Since the mass in running order – as an element of the actual mass – is subject to a legally permissible tolerance of  $\pm 5 \%$  (see no. 2), the actual mass may also deviate accordingly from the stated nominal value.



5. Pay-mass and minimum pay-mass

The installation of optional equipment is also subject to technical and legal limits: Only so much optional equipment can be ordered and fitted at the factory that sufficient free weight remains for baggage and other accessories ("pay-mass") without exceeding the technically permissible maximum laden mass. The pay-mass is calculated by subtracting the mass in running order (nominal value according to sales documents, see no. 2 above), mass of the optional equipment and the mass of the passengers (see no. 3 above) from the technically permissible maximum laden mass (see no. 1 above). The EU regulations stipulate a fixed minimum pay-mass for motorhomes, which must remain as a minimum for baggage or other non-factory-fitted accessories. This minimum pay-mass is calculated as follows:

$$\text{Minimum pay-mass in kg} \geq 10 \times (n + L)$$

Where: "n" is the maximum number of passengers plus the driver and "L" is the overall length of the vehicle in metres.

For a motorhome with a length of 6 m and 4 approved seats, the minimum pay-mass is therefore e. g.  $10 \text{ kg} \times (4 + 6) = 100 \text{ kg}$ .

To ensure that the minimum pay-mass is maintained, there is a maximum combination of optional equipment that can be ordered for each vehicle model. In the above example with a minimum pay-mass of 100 kg, the total mass of optional equipment for a vehicle with four permitted seats and a mass in running order of 2,850 kg should not exceed 325 kg:

$$\begin{aligned} &3,500 \text{ kg} \quad \text{technically permissible maximum laden mass} \\ &- 2,850 \text{ kg} \quad \text{mass in running order} \\ &- 3 \times 75 \text{ kg} \quad \text{mass of the passengers} \\ &- 100 \text{ kg} \quad \text{minimum pay-mass} \\ &= 325 \text{ kg} \quad \text{maximum permissible mass of optional equipment} \end{aligned}$$

It is important to note that this calculation is based on the default value for mass in running order as defined in the type-approval procedure, without taking into account the permissible weight deviations for mass in running order (see no. 2 above). If the maximum permissible value for the optional equipment of (in the example) 325 kg is almost or completely exhausted, an upward weight deviation can therefore result in the minimum pay-mass of 100 kg being met mathematically using the default value for the mass in running order, although in fact there is no corresponding load capacity. Here, too, an example calculation for a vehicle with four seats, whose real weighed mass in running order is 2 % above the nominal value:

$$\begin{aligned} &3,500 \text{ kg} \quad \text{technically permissible maximum laden mass} \\ &- 2,907 \text{ kg} \quad \text{real weighed mass in running order (+ 2 % compared to the} \\ &\quad \text{stated value of 2,850 kg)} \\ &- 3 \times 75 \text{ kg} \quad \text{mass of the passengers} \\ &- 325 \text{ kg} \quad \text{optional equipment (maximum permissible value)} \\ &= 43 \text{ kg} \quad \text{actual load capacity (< minimum pay-mass of 100 kg)} \end{aligned}$$

In order to avoid such a situation, Bürstner further reduces the maximum permissible weight of the total optional equipment that can be ordered on a model-specific basis. The limitation of optional equipment is intended to ensure that the minimum pay-mass, i.e. the legally prescribed free mass for baggage and retrofitted accessories, is actually available for the vehicle load capacity of the vehicles delivered by Bürstner.

Since the weight of a specific vehicle can only be determined when it is weighed at the end of the line, in very rare cases a situation may arise in which the minimum pay-mass at the end of the line is not guaranteed, despite this limitation of optional equipment. In order to guarantee the minimum pay-mass even in these cases, Bürstner will check together with your trade partner and you before delivery of the vehicle whether, for example, the vehicle is loaded up, seats are reduced or optional equipment is removed.

#### 6. Effects of tolerances of the mass in running order on the pay-mass

Regardless of the minimum pay-mass, you should note that unavoidable production-related fluctuations in the mass in running order – both upwards and downwards – have a mirror-image effect on the remaining load capacity: If you order our example vehicle (see no. 3. above), for example, with optional equipment with a total weight of 150 kg, the calculated pay-mass based on the default value for the mass in running order is 275 kg. The load capacity actually available may deviate from this value due to tolerances and may be higher or lower. If the mass in running order of your vehicle is, for example, permissibly 2 % higher than stated in the sales documents, the load capacity is reduced from 275 kg to 218 kg:

3,500 kg technically permissible maximum laden mass  
 - 2,907 kg real weighed mass in running order (+ 2 % compared to the stated value of 2,850 kg)  
 - 3 x 75 kg mass of the passengers  
 - 150 kg optional equipment ordered for the specific vehicle  
 = 218 kg actual load capacity

As a precaution to ensure that the calculated pay-mass is actually given, you should therefore take the possible and permissible tolerances for the mass in running order into account when configuring your vehicle.

We also recommend that you weigh the laden motorhome on a non-automatic scale before each journey and, taking the individual weight of the passengers into account, determine whether the technically permissible maximum laden mass and the technically permissible maximum mass on the axle are observed.

12 V fuses ..... 155  
 For Thetford toilet ..... 158  
 Heater for waste water pipes ..... 158  
 On the living area battery ..... 156  
 On the relay box AD01 ..... 157  
 On the starter battery (Fiat) ..... 156  
 On the starter battery (Ford) ..... 156  
 12 V indicator lamp ..... 150  
 12 V main switch ..... 148  
 12 V power supply ..... 141  
 Switching on ..... 148  
 Troubleshooting ..... 251  
 230 V connection ..... 65, 152, 153  
 Troubleshooting ..... 250  
 230 V fuse ..... 159  
 Position ..... 269  
 230 V fuse box ..... 159  
 230 V indicator lamp ..... 151  
 230 V power supply ..... 152  
 230 V power supply see also 230 V  
 connection ..... 152  
 3-way valve ..... 175

**A**

Accessories, fitting ..... 18  
 Actual mass ..... 27  
 AdBlue, topping up ..... 61  
 Add-on parts see optional equipment ..... 18  
 Add-on parts, securing ..... 43  
 Adjustable head section, fixed bed ..... 109  
 Air conditioning unit (Telair)  
 Care ..... 224  
 Filter, cleaning ..... 224  
 Operating modes ..... 180  
 Switching off ..... 181  
 Switching on ..... 180  
 Troubleshooting ..... 256  
 Ventilation grill, cleaning ..... 224  
 Air outlet nozzles, adjustment ..... 167  
 Antenna alignment ..... 67  
 Antenna alignment, automatic ..... 66  
 Appliances ..... 165  
 Manuals ..... 18  
 Automatic power selection (AES) ..... 189  
 Awning ..... 69

**B**

Basic equipment ..... 27  
 Battery alarm ..... 150  
 Battery cut-off switch ..... 146  
 Battery monitor ..... 147  
 Battery see starter battery or living area  
 battery ..... 141, 142

Battery selector switch ..... 147  
 Battery voltage, displaying ..... 149  
 Bed widening, securing ..... 43  
 Bed widening, single beds ..... 126  
 Beds ..... 109  
 Fall out protection ..... 127  
 Before the journey ..... 25  
 Bike rack  
 Bicycles, loading ..... 37, 38  
 Load ..... 36  
 Lowerable ..... 38  
 Not lowerable ..... 37  
 Travelling with a loaded bike rack ..... 36  
 Blind, cleaning ..... 220  
 Blind, skylight with snap latch  
 Closing ..... 97  
 Opening ..... 97  
 Blind, window  
 Closing ..... 92  
 Opening ..... 93  
 Boiler ..... 166  
 Boiler (Alde)  
 Emptying ..... 177  
 Water, filling with ..... 177  
 Boiler (Truma) ..... 167  
 Emptying ..... 171  
 Hot water production, switching off ..... 170  
 Hot water production, switching on ..... 170  
 Operating modes ..... 171  
 Position ..... 269  
 Safety/drainage valve ..... 170  
 Troubleshooting ..... 253  
 Water, filling with ..... 171  
 Brakes ..... 51  
 Check ..... 51, 249  
 Braking system, troubleshooting ..... 249  
 Breakdown services in Europe ..... 277  
 Bulbs, changing  
 Rear lights ..... 235  
 Side lights ..... 236  
 Surface mounted light ..... 238  
 Types of external bulbs ..... 236  
 Butane gas ..... 21, 130

**C**

Cable reel ..... 153  
 Camping gas bottles, use ..... 22, 131  
 Camping in winter ..... 279  
 Capacity of the battery ..... 140  
 Caravan couplings ..... 39  
 Tow ball ..... 38  
 With detachable ball neck ..... 38





Doors, securing ..... 43  
 Drain cock, waste water tank ..... 208  
     Position ..... 269  
 Drain cocks, position ..... 178, 269  
 Drinking water filler neck ..... 202  
     Closing ..... 202  
     Opening ..... 202  
 Driver's seat ..... 55  
 Driving speed ..... 50  
 Driving the vehicle ..... 49

**E**

Electrical system  
     230 V connection, troubleshooting ..... 250  
     Explanation of terms ..... 139  
     Lighting, troubleshooting ..... 250  
     Safety instructions ..... 23  
     Troubleshooting ..... 250  
 Entrance step ..... 63  
     Care ..... 218  
     Electrically operated ..... 40  
     Extending ..... 41  
     Indicator lamp ..... 40  
     Retracting ..... 41  
 Environmental tips ..... 10  
 Exterior lighting  
     Check ..... 46  
     Illuminant, replacing ..... 233  
     Troubleshooting ..... 250  
 External care ..... 217  
 External connection see 230 V connection ..... 65  
 External flaps ..... 74, 77  
     Flap lock ..... 74, 75, 76, 77  
 External gas connection ..... 133  
 External shower ..... 127  
     Connecting ..... 128  
     Emptying ..... 128  
 External socket ..... 160  
 Extractor hood ..... 186  
     Active carbon filter, replacing ..... 231  
     Care ..... 223  
     Metal grease filter, cleaning ..... 223  
     Troubleshooting ..... 257

**F**

Fall out protection, rear bed ..... 127  
 Fault current protection switch ..... 152  
     Check ..... 160  
 Filling level of the waste water tank,  
 displaying ..... 150  
 Filling level of the water tank, displaying ..... 150  
 Filling the tank ..... 60  
 Fire  
     Extinguishing ..... 17  
     Response to ..... 17

Fire prevention ..... 17  
 Fire risks, avoidance ..... 17  
 FI-switch see fault current protection  
 switch ..... 159  
 Fixed bed ..... 109  
     Closing ..... 109  
     Head section, lowering ..... 110  
     Head section, raising ..... 110  
     Opening ..... 109  
 Fixed bed, height-adjustable via strap  
 system ..... 110  
 Fixed table ..... 102, 103  
     Table leg ..... 102  
     Table surface, extending ..... 103  
     Table top, reducing size ..... 103  
     Table top, shifting ..... 103  
 Flap lock ..... 77  
     Closing ..... 75, 76, 77  
     Opening ..... 75, 76, 77  
     Service flap ..... 76  
     Square ..... 77  
     With push button ..... 76  
     With recessed handle ..... 75  
 Flat screen ..... 85  
     Positioning ..... 86, 87  
     Storing away ..... 86, 87, 88  
 Floor compartment ..... 79  
     Closing ..... 79  
     Opening ..... 79  
 Floor warming unit, electrical  
     Overload protection ..... 179  
     Switching off ..... 179  
     Switching on ..... 179  
 Folding table ..... 55  
 Forced ventilation ..... 18, 88  
 Front passenger's seat ..... 55  
 Fuel filler neck ..... 60  
 Furniture flaps ..... 78  
     Closing ..... 78  
     Opening ..... 78  
 Furniture flaps, troubleshooting ..... 266  
 Furniture surfaces, cleaning ..... 219  
 Fuse box ..... 159  
 Fuses  
     12 V fuses ..... 155  
     230 V fuse ..... 152, 159  
     For Thetford toilet ..... 158  
     Heater for waste water pipes ..... 158  
     On the relay box AD01 ..... 157  
     On the starter battery ..... 156  
     On the transformer/rectifier EBL 119 ..... 157  
 Fuses see 12 V fuses and 230 V fuse ..... 155

# Index

---

## G

Garage flap .....	75
Garage flap emergency release .....	75
Gas bottle compartment .....	21, 130
Gas bottles .....	130
Changing .....	137
Safety instructions .....	22, 130
Gas burner .....	183
Switching off .....	184
Switching on .....	183
Gas connection, external .....	133
Gas cooker .....	181
Cleaning .....	219
Switching off .....	182
Switching on .....	182
Troubleshooting .....	256
Gas cooker, see also cooker .....	183
Gas grill .....	183, 184
Gas isolator tap .....	132
Symbols .....	132, 165
Gas odour .....	21, 129, 253
Gas oven .....	183
Switching off .....	185
Switching on .....	184
Gas pressure regulator, screw connections .....	131
Gas regulator .....	45
Gas supply in European countries .....	278
Gas system .....	
Defect .....	21, 129, 253
General instructions .....	20
No gas .....	253
Safety instructions .....	20
Switching automatics .....	134
Troubleshooting .....	253
Grill .....	184
Switching off .....	185
Switching on .....	185
Ground plans .....	269

## H

Handbrake .....	63
Applying .....	18
Handling of tyres .....	243
Headrests .....	58
Heat exchanger (Alde) .....	
Position .....	176
Shutting off .....	176
Starting .....	176
Heater .....	166
Air outlet nozzles, adjustment .....	167
Circulation fan .....	167
Heating circuit, regulating .....	175
Hot air distribution .....	167
Initial start-up .....	166
Troubleshooting .....	253

Heater for the waste water tank and waste water pipes .....	209
Fuses .....	158
Heki skylight .....	98
Closing .....	98
Insect screen .....	99
Opening .....	98
Roman shade .....	99
Ventilation position .....	98
Help on Europe's roads .....	277
High rate of gas consumption .....	21, 129, 253
High-pressure cleaner, washing with .....	217
Hinged window .....	
Blind .....	92
Closing .....	91
Continuous ventilation .....	91
Insect screen .....	93
Opening .....	90
Roman shade .....	93
Hot air distribution .....	167
Hot-air heater .....	167
Circulation fan .....	167
Operating modes .....	171
Operating unit .....	168
Position .....	269
Troubleshooting .....	253
Hot-water heater .....	
3-way valve .....	175
Auxiliary circulating pump .....	176
Care .....	231
Control unit .....	173
Fluid level, check .....	232
Heat exchangers .....	175
Heating fluid, topping up .....	232
Heating system, bleeding .....	233
Maintenance work .....	231
Rotational speed, circulating pump .....	174

## I

Illuminant, replacing .....	
Exterior lighting .....	233
Interior lighting .....	237
Indicator lamp, 12 V power supply .....	150
Indicator lamp, 230 V power supply .....	151
Indicator lamp, toilet .....	213, 214
Information stickers .....	240
Inner door, troubleshooting .....	266
Insect screen door .....	
Closing .....	74
Opening .....	74
Insect screen, cleaning .....	220
Insect screen, Heki skylight .....	
Closing .....	99
Opening .....	99
Insect screen, skylight with snap latch .....	97

Insect screen, Sunroof skylight  
 Closing..... 101  
 Opening ..... 101  
 Insect screen, window  
 Closing..... 93  
 Opening ..... 93  
 Inspection plan ..... 283  
 Inspection time limits ..... 229  
 Inspection work ..... 230  
 Inspections..... 230  
 Inspections, official ..... 229  
 Installation positions ..... 269  
 Interior care ..... 219  
 Interior lighting, bulbs, changing..... 237  
 Interior lighting, troubleshooting..... 250  
 ISOFIX child safety seat mounting system ..... 54

**J**

Jointed arm, two-piece ..... 86

**K**

Keys ..... 25  
 Kitchen extension board ..... 42

**L**

Lamps ..... 237  
 Cleaning..... 219  
 Lay-up  
 During winter..... 227  
 Temporary ..... 225  
 Leakage water inside the vehicle ..... 264  
 Leather covers, cleaning ..... 219  
 Lift-off table ..... 105, 106  
 Moving in a crossways direction..... 105  
 Moving in a lengthways direction..... 105  
 Shifting lengthwise and crosswise..... 106  
 Table leg ..... 105, 106  
 Table top ..... 105, 106  
 Table top, lowering..... 105, 106  
 Table top, moving upwards ..... 105, 106  
 Table top, reducing size ..... 106  
 Turning..... 105  
 Light control ..... 82  
 Light switch  
 Living area..... 81  
 Toilet compartment ..... 80  
 Lighting  
 Front..... 234  
 Illuminant, replacing ..... 233  
 Lamps, cleaning..... 219  
 Rear ..... 235  
 Side ..... 236  
 Troubleshooting ..... 250  
 Lithium battery ..... 143

Living area battery ..... 142  
 Battery alarm..... 150  
 Fuses ..... 156  
 Instructions..... 142  
 Maintenance work ..... 231  
 Position..... 269  
 Troubleshooting..... 250, 252  
 Voltage, displaying..... 149  
 Load..... 31  
 Bike rack ..... 36  
 Rear garage ..... 35  
 Rear storage space..... 35  
 Load see also payload..... 31  
 Lock  
 Conversion door..... 72  
 Doors ..... 71  
 External flap ..... 74, 75, 76, 77  
 Furniture flap ..... 78  
 Low beam ..... 234

**M**

Main beam ..... 234  
 Maintenance work ..... 230  
 Air conditioning unit (Telair)..... 224  
 Doors..... 230  
 Extractor hood ..... 231  
 Hot-water heater..... 231  
 Living area battery..... 231  
 Marker light..... 236  
 Mass in running order ..... 27, 30  
 Mechanical steady legs  
 Extension..... 64  
 Length, adjustment ..... 64  
 Retraction ..... 65  
 Microwave oven  
 Switching off ..... 186  
 Switching on..... 186  
 Troubleshooting..... 257  
 Mobile lamp..... 84  
 Monitor, reversing camera ..... 50

**N**

Net curtains, cleaning ..... 219  
 Nose weight..... 38

**O**

Official inspections..... 229  
 Off-load voltage ..... 139  
 Operating modes, air conditioning unit  
 (Telair) ..... 180  
 Operating modes, boiler (Truma) ..... 171  
 Operating modes, hot-air heater..... 171  
 Operating modes, refrigerator (Dometic) ..... 189  
 Operating modes, refrigerator (Thetford)..... 192





# Index

---

Operating unit, hot-air heater.....	168
Optional equipment.....	29
Certification.....	9
Description.....	9
Safety instructions.....	18
Weights.....	267
Overloading.....	31

## P

Panel (LT 96).....	148
12 V indicator lamp.....	150
12 V main switch.....	148
230 V indicator lamp.....	151
Battery voltage, displaying.....	149
Button for water pump.....	150
Connection diagram.....	162
Filling level of the waste water tank, displaying.....	150
Filling level of the water tank, displaying.....	150
Panel, see also display.....	148
Parking light.....	234
Payload.....	26
Permissible gross weight see technically permissible maximum laden mass.....	26
Personal equipment.....	29
Pilot seat see driver's seat and front passenger's seat.....	55
Position	
Battery selector switch.....	147
Starter battery.....	141
Propane gas.....	21, 130
Pull-down bed, electrically operated.....	111, 114
Access ladder.....	113
Emergency operation.....	113, 116
Lowering.....	112, 115
Raising.....	112, 115
Retaining belts, tightening.....	113
PVC-floor covering, cleaning.....	219

## R

Ramps.....	63
Rear axle load.....	38
Rear bed, fall out protection.....	127
Rear garage.....	35
Rear storage space.....	35
Refrigerator.....	65, 187
Boost mode, switching off.....	198
Boost mode, switching on.....	198
Change-over between energy sources.....	190, 193
Cooling power, setting.....	191, 192, 194
Door lock.....	198
Frame heater.....	191
Night mode, switching off.....	196, 198
Night mode, switching on.....	196, 198

Operating mode, selecting.....	191, 192, 194
Operating modes.....	189, 192
Switching off.....	191, 192, 194, 195, 197
Switching on.....	190, 192, 194, 195, 197
Temperature, adjusting.....	196, 197
Troubleshooting.....	258, 262, 263
Ventilation grill, removing.....	187
Refrigerator door	
Closing.....	199, 200
Locking in the ventilation position.....	199
Opening.....	199
Refrigerator ventilation grill, removing.....	187
Registration.....	25
Remote control, central locking system.....	71
Reversing camera.....	50
Risk of frost damage.....	23, 201, 206
Road safety.....	46
Checklist.....	46
Notes for.....	19
Roman shade, cleaning.....	220
Roman shade, driver's window	
Closing.....	95
Opening.....	95
Roman shade, front passenger's window	
Opening.....	95
Shading.....	95
Roman shade, Heki skylight	
Closing.....	99
Opening.....	99
Roman shade, pleated shades.....	59
Roman shade, Sunroof skylight	
Closing.....	101
Opening.....	101
Roman shade, window	
Closing.....	93
Opening.....	93
Roman shade, window of conversion door	
Closing.....	73
Opening.....	73
Roman shade, windscreen	
Opening.....	95
Shading.....	94
Roman shades, Remis.....	60

## S

Safety cut-out.....	160
Safety instructions.....	17
Changing wheels.....	243
Cooker.....	181
Electrical system.....	23
Fire prevention.....	17
Road safety.....	19
Towing.....	20
Water system.....	23
Safety knob, hinged window.....	90, 99





# Index

---

Toilet compartment.....	210
Light switch .....	80
Odour transformer.....	216
Ventilation.....	210
Toll regulations in European countries.....	278
Total discharge .....	140
Towing.....	20
General instructions.....	38
Safety instructions.....	20
Traffic rules in foreign countries .....	277
Transformer/rectifier (EBL 119).....	145
Circuit diagram.....	161
Functions .....	146
Position.....	146
Transformer/rectifier, position.....	269
Travel checklists.....	280
Travel cots suitable for children.....	111, 114
Troubleshooting	
12 V power supply.....	251
230 V connection.....	250
Air conditioning unit (Telair).....	256
Battery.....	250
Body.....	266
Boiler.....	253
Braking system.....	249
Electrical system .....	250
Extractor hood.....	257
Furniture flaps.....	266
Gas cooker.....	256
Gas system .....	253
Heater .....	253
Hot-air heater.....	253
Inner door .....	266
Lighting.....	250
Living area battery.....	250
Microwave oven.....	257
Refrigerator.....	258
Satellite unit .....	249
Starter battery .....	250
Toilet.....	264
Water supply.....	264
Tube lamp in the rear garage .....	83
TV socket .....	160
Tyre change see wheels, changing.....	243
Tyre specifications .....	243
Tyres	
Certification.....	243
Excessive wear.....	19, 46, 241, 247
General instructions.....	241
Handling .....	243
Load-carrying capacity .....	244
Tyre pressure .....	247
Tyre selection .....	242
<b>U</b>	
Upholstery, cleaning.....	219
USB socket.....	140
<b>V</b>	
Vario blind .....	95
Vehicle identification plate.....	240
Vehicle lighting see lighting.....	233
Vehicle load capacity.....	25
Calculation.....	30
Composition.....	27
Example calculation .....	27
Vehicle load capacity see also load .....	25
Vehicle, washing.....	218
Ventilation.....	88
Toilet compartment .....	210
Volume of waste water, displaying.....	150
Volume of water, displaying .....	150
<b>W</b>	
Wardrobe light .....	82
Warning stickers.....	240
Washing with a high-pressure cleaner .....	217
Waste water tank.....	208
Care .....	223
Cleaning opening .....	208
Emptying.....	208
Filling level, displaying.....	150
Heater.....	209
Troubleshooting .....	264
Water pipes, cleaning.....	221
Water pump .....	201, 203
Button.....	150
Position .....	269
Water supply	
General.....	201
Troubleshooting .....	264
Water system .....	202
Care .....	221
Cleaning.....	221
Disinfect.....	222
Drinking water filler neck.....	202
Emptying.....	206
Filling.....	203
Safety instructions .....	23
Water tank.....	202
Cleaning.....	221
Draining water .....	206
Filling level, displaying.....	150
Overflow .....	205
Position .....	269
Water, refilling.....	205

---

Weatherproof guarantee		Windows .....	89
Bürstner Warranty Conditions .....	13	Blind .....	92
Proof of water ingress tests .....	15	Insect screen .....	92, 93
Vehicle data .....	15	Roman shade .....	93, 94
Water ingress test (certificates).....	16	Shade .....	94
Weight details for optional equipment .....	267	Windows, cleaning .....	218
Wheel chocks .....	63	Winter care .....	224
Wheel rim size .....	244	Winter operation.....	225
Wheel rim type.....	241	Work top, cleaning.....	220
Wheel, changing .....	246		
Window, conversion door			
Roman shade, closing .....	73		
Roman shade, opening .....	73		







**Bürstner GmbH & Co. KG**  
Weststraße 33  
D-77694 Kehl / Rhein

**Bürstner Service-Center**  
Elsässer Straße 80  
D-77694 Kehl / Neumühl  
[faq.buerstner.com](http://faq.buerstner.com)

[www.buerstner.com](http://www.buerstner.com)



3572699 - 11.2023